

CipherLab User Guide

1660/1661 Barcode Scanner

Setup barcodes included.

Version 1.32



Copyright © 2008~2015 CIPHERLAB CO., LTD.
All rights reserved

The software contains proprietary information of CIPHERLAB CO., LTD.; it is provided under a license agreement containing restrictions on use and disclosure and is also protected by copyright law. Reverse engineering of the software is prohibited.

Due to continued product development this information may change without notice. The information and intellectual property contained herein is confidential between CIPHERLAB and the client and remains the exclusive property of CIPHERLAB CO., LTD. If you find any problems in the documentation, please report them to us in writing. CIPHERLAB does not warrant that this document is error-free.

No part of this publication may be reproduced, stored in a retrieval system, or transmitted in any form or by any means, electronic, mechanical, photocopying, recording or otherwise without the prior written permission of CIPHERLAB CO., LTD.

For product consultancy and technical support, please contact your local sales representative. Also, you may visit our web site for more information.

The CipherLab logo is a registered trademark of CIPHERLAB CO., LTD.

All brand, product and service, and trademark names are the property of their registered owners.

The editorial use of these names is for identification as well as to the benefit of the owners, with no intention of infringement.

CIPHERLAB CO., LTD.

Website: <http://www.cipherlab.com>

IMPORTANT NOTICES

FOR USA

This equipment has been tested and found to comply with the limits for a **Class B** digital device, pursuant to Part 15 of the FCC Rules. These limits are designed to provide reasonable protection against harmful interference in a residential installation. This equipment generates, uses and can radiate radio frequency energy and, if not installed and used in accordance with the instructions, may cause harmful interference to radio communications. However, there is no guarantee that interference will not occur in a particular installation. If this equipment does cause harmful interference to radio or television reception, which can be determined by turning the equipment off and on, the user is encouraged to try to correct the interference by one or more of the following measures:

- ▶ Reorient or relocate the receiving antenna.
- ▶ Increase the separation between the equipment and receiver.
- ▶ Connect the equipment into an outlet on a circuit different from that to which the receiver is connected.
- ▶ Consult the dealer or an experienced radio/TV technician for help.

This device complies with Part 15 of the FCC Rules. Operation is subject to the following two conditions: (1) This device may not cause harmful interference, and (2) this device must accept any interference received, including interference that may cause undesired operation.

FOR CANADA

This digital apparatus does not exceed the Class B limits for radio noise emissions from digital apparatus as set out in the interference-causing equipment standard entitled "Digital Apparatus," ICES-003 of Industry Canada. This device complies with Part 15 of the FCC Rules. Operation is subject to the following two conditions: (1) This device may not cause harmful interference, and (2) this device must accept any interference received, including interference that may cause undesired operation.

Cet appareil numérique respecte les limites de bruits radioélectriques applicables aux appareils numériques de Classe B prescrites dans la norme sur le matériel brouilleur: "Appareils Numériques," NMB-003 édictée par l'Industrie.

FOR HAND-HELD PRODUCT WITH RF FUNCTIONS

The 1660/1661 unit (FCC ID: Q3N-1660, Q3N-1661) complies with FCC radiation exposure limits set forth for uncontrolled environment and meets the FCC radio frequency (RF) Exposure Guidelines in Supplement C to OET65. The unit has very low level of RF energy that it is deemed to comply without testing of specific absorption ratio (SAR).

The 3610 unit (FCC ID: Q3N-3610) complies with FCC radiation exposure limits set forth for an uncontrolled environment. This equipment should be installed and operated with minimum distance 20 cm between the radiator & your body. It only operated in hand-held used. If you only transfer data to the host wirelessly, please keep the minimum distance 20 cm between machine & your body.

SAFETY PRECAUTIONS

RISK OF EXPLOSION IF BATTERY IS REPLACED BY AN INCORRECT TYPE. DISPOSE OF USED BATTERIES ACCORDING TO THE INSTRUCTIONS.

- ▶ DO NOT disassemble, incinerate or short circuit the battery.
- ▶ DO NOT expose the scanner or the battery to any flammable sources.
- ▶ For green-environment issue, it's important that batteries should be recycled in a proper way.
- ▶ Under no circumstances, internal components are self-serviceable.

CARE & MAINTENANCE

- ▶ Use a clean cloth to wipe dust off the scanning window and the body of the scanner. DO NOT use/mix any bleach or cleaner.
- ▶ If you want to put away the scanner for a period of time, download the collected data to a host computer when in the memory mode, and then take out the battery. Store the scanner and battery separately.
- ▶ When the scanner resumes its work, make sure the battery is fully charged before use.
- ▶ Keep the scanner away from any magnets and magnetic fields to prevent the laser engine from malfunctioning.
- ▶ If you shall find the scanner malfunctioning, write down the specific scenario and consult your local sales representative.

RELEASE NOTES

Version	Date	Notes
1.32	Apr. 22, 2015	<ul style="list-style-type: none">▶ Modified: 1.2.3 – “Record Count of Memory” setting barcodes added▶ Modified: Wording referring to “CD-ROM” removed
1.31	May 09, 2014	<ul style="list-style-type: none">▶ Modified: Care & Maintenance – “Keep the scanner away from any magnets and magnetic fields to prevent the laser engine from malfunctioning.” added▶ Modified: 1.1.1 – Enable/Disable the [Delete] key barcodes added▶ Modified: 1.1.3 – Power Level (1661)▶ Modified: 1.2.1 – Free Memory▶ New: 1.14.3 – Hardware Reset▶ New: 2.1.8 – BT HID Transmit Speed▶ New: 2.1.9 – BT HID Slave/Master Switching▶ New: 2.1.10 – BT HID Auto-Reconnection (1661 only)▶ New: 2.5.2 – Activate USB Virtual COM_CDC (100031)▶ New: 4.8.3 – Conversion Format▶ New: 4.10.3 – GS1 Formatting, Application ID Mark▶ New: 4.11.1 – ISBT Concatenation▶ New: 4.16.5 – Field Separator (GS Character)▶ New: 4.16.6 – GS1 Formatting, Application ID Mark▶ Modified: Appendix I – Note for upgrading 3610 firmware added▶ Modified: Appendix II – ShowScanner, SelectScannerN added▶ Modified: Appendix III – remove “Send” from “CR*/Send/ENTER*”
1.30	Dec. 25, 2012	<ul style="list-style-type: none">▶ Modified: 2.5.1/2.7/3.1 Required USB Virtual COM Driver version 5.4▶ Modified: 2.1.1/2.4.1/2.6.1 HID Keyboard Type — add #78 (Swiss German)/ #79 (Danish)
1.20	Apr. 09, 2012	<ul style="list-style-type: none">▶ New: Add 1.1.3 Power Level information▶ New: Add 1.2.1 Free Memory information▶ New: Add 4.1.1 Security Level
1.19	Feb. 20, 2012	<ul style="list-style-type: none">▶ New: Add Upgrading USB Bridge Firmware
1.18	Nov. 28, 2011	<ul style="list-style-type: none">▶ Modified: 4.10 Change GS1-128 default value to Enable▶ New: Add New Serial Command “#@RDSN<CR>”
1.17	Jun. 28, 2011	<ul style="list-style-type: none">▶ Modified: 2.1.1 Activate BT HID & Select Keyboard Type — add #77 PCAT (Hungarian)▶ Modified: 2.4.1 Activate USB HID & Select Keyboard Type — add #77 PCAT (Hungarian)▶ Modified: 2.6.1 Activate USB HID & Select Keyboard Type — add #77 PCAT (Hungarian)

- | | | |
|------|---------------|--|
| 1.16 | Apr. 25, 2011 | <ul style="list-style-type: none"> ▶ Modified: 1.2.2 Memory Mode — add Send Data Time-out (101024) ▶ Modified: 2.1 BT HID — add Inter-Character Delay ▶ Modified: 2.4 USB HID via 3610 — add Inter-Character Delay ▶ Modified: 2.6 Direct USB HID (1661 Memory Mode Only) — add Inter-Character Delay ▶ Modified: Specifications — Power Adaptor |
| 1.15 | Jan. 07, 2011 | <ul style="list-style-type: none"> ▶ Modified: add support for 1661 to send memory data via Direct USB ▶ Modified: Introduction, Product Highlights — add CipherConnect ▶ New: 1.13 1661 Using Direct USB Cable ▶ New: 1.14 Hardware Reset ▶ Modified: 4.10 GS1-128 (EAN-128) — Cannot read when disabled since firmware v1.30 for 1660 ▶ Modified: 5.6.1 Edit a Concatenation of Barcodes — Code type for ISBT 128 ▶ New: 6.4.5 Pause Field Setting ▶ Modified: 6.5 Configuring Format — Define Transmission Sequence (add Pause Field, Null Character Field) |
| 1.14 | Nov. 26, 2010 | <ul style="list-style-type: none"> ▶ New: add 1661, Direct USB for charging only (Direct USB allows no data transmission except for firmware upgrade) ▶ Modified: Introduction — Charging indication on 1661; charging via battery charger ▶ Modified: Introduction, Symbologies Supported — add support of more RSS symbologies ▶ New: Quick Start — Create One-Scan Setup Barcodes (e.g. "109950" → "#@109950#") ▶ Modified: 1.1.2 Auto Power Off & Power-Saving ▶ Modified: 1.2.1 Transmit Buffer — supports 1661 ▶ Modified: 1.4 Beeper — describe "Low Battery Alarm" ▶ New: 1.4.4 Low Battery Alarm (1661) ▶ New: 2.1.6 Keypad Support for iPhone/iPad ▶ Modified: 3.2.3 Connect to Dongle — describe random PIN in Step 12 ▶ Modified: 4.16 GS1 DataBar (RSS Family) ▶ Modified: 4.16.2 GS1 DataBar Omnidirectional (RSS-14) ▶ Modified: 4.16.3 GS1 DataBar Expanded (RSS Expanded) ▶ Modified: Specifications — 1661 power adaptor |
| 1.13 | May 12, 2010 | <ul style="list-style-type: none"> ▶ Modified: 5.2 Character Substitution — add table for Scan Code/Normal Key |
| 1.12 | Apr. 09, 2010 | <ul style="list-style-type: none"> ▶ Modified: 2.1.3 Keyboard Settings — BT HID supports "Alphabets Layout" ▶ Modified: 2.4.2 Keyboard Settings — USB HID supports "Alphabets Layout" ▶ New: 3.1.3 Configure Related Settings — Sniff Mode ▶ Modified: Appendix III Keyboard Wedge Table — remove settings for user-defined scan code ▶ Modified: Appendix III Keyboard Wedge Table — provide examples |

- | | | |
|------|---------------|--|
| 1.11 | Feb. 02, 2010 | <ul style="list-style-type: none"> ▶ Modified: 2.2 BT SPP Slave ▶ Modified: 2.3 BT SPP Master |
| 1.10 | Jan. 05, 2010 | <ul style="list-style-type: none"> ▶ Modified: Restore System Defaults — add key combination ▶ Modified: 1.1.1 How to Operate the Scanner — add key combination to restore defaults during operation ▶ Modified: 1.1.2 Auto Power Off & Power-Saving ▶ Modified: 2.1.1 Activate BT HID & Select Keyboard Type — add Turkish ▶ Modified: 2.1.5 HID Character Transmit Mode ▶ Modified: 2.3.1 Activate USB HID & Select Keyboard Type — add Turkish ▶ Modified: 2.3.4 HID Character Transmit Mode ▶ Modified: 4.9.4 Security Level ▶ Modified: 5.2.2 Symbologies for Character Substitution (All 3 Sets) — add ISBT 128 ▶ Modified: 5.4.1 Select Pre-defined Code ID — add ISBT 128 ▶ Modified: 5.4.2 Change Code ID — add ISBT 128 ▶ Modified: 5.5 Length Code — add ISBT 128 ▶ Modified: 6.3.1 Applicable Code Type (for Editing Format) — add ISBT 128 |
| 1.09 | July 07, 2009 | <ul style="list-style-type: none"> ▶ Modified: 1.1.2 Auto Power Off & Power-Saving — add setup barcode for Power-Saving setting (101021) ▶ Modified: 3.2.2 Configure Related Settings — Authentication ▶ Modified: Appendix II Host Serial Commands |
| 1.08 | Apr. 29, 2009 | <ul style="list-style-type: none"> ▶ Modified: Using 3610 — change LED of Serial command mode (Blue, flashing) ▶ Modified: 1.1.2 Auto Power Off — change LED on/off ratio, etc. ▶ Modified: 1.3 LED Indicator — change LED on/off ratio, etc. ▶ Modified: 1.4 Beeper — add notification for PIN code, etc. ▶ Modified: 3.1.1 Connect to 3610 — One beep for each setup barcode ▶ Modified: 4.12.3 Code Length Qualification — MSI must include checksum ▶ Modified: 5.6.2 Activate the Concatenation of Barcodes — add description of LED and beeper ▶ Modified: Appendix I Firmware Upgrade ▶ Modified: Appendix II Host Serial Commands ▶ Modified: Appendix IV (Reject Random PIN Request) |

1.07	Apr. 09, 2009	<ul style="list-style-type: none"> ▶ New: BT Transponder (3610) ▶ Modified: 1.2.1 Transmit Buffer — add setup barcodes ▶ Modified: 1.4 Beeper — Transmit Buffer Disabled ▶ Modified: 2.1 BT HID — change setup barcode (100006) ▶ New: 2.3 USB HID via 3610 — add setup barcode (100005) ▶ New: 2.4 USB Virtual COM via 3610 — add setup barcode (100004) ▶ Modified: 3.2.2 Configure Related Settings — Use preset or random PIN for authentication ▶ Modified: 5.7 Removal of Special Character ▶ Modified: Appendix IV — Use preset or random PIN for authentication
1.06	Feb. 26, 2009	<ul style="list-style-type: none"> ▶ Modified: 1.1.3 Auto Power Off ▶ Modified: 1.2.2 Memory Mode — 256 KB flash memory ▶ Modified: 1.3 LED Indicator ▶ Modified: 1.6 Scan Modes — add Alternate Mode to table ▶ New: 1.6.8 Alternate Mode — add setup barcode (100203) ▶ Modified: 1.8 Delay between Re-read — add Alternate Mode ▶ Modified: 2.1 BT HID — change setup barcode (100006) ▶ Modified: 3.2.2 Configure Related Settings — add setup barcode (109973) for Clear PIN Code ▶ Modified: 4.10 GS1-128 (EAN-128) ▶ Modified: 4.16 GS1 DataBar (RSS Family) ▶ Modified: 4.16.2 GS1 DataBar Omnidirectional (RSS-14) ▶ Modified: 4.16.3 GS1 DataBar Expanded (RSS Expanded) ▶ Modified: 4.16.4 GS1 DataBar Limited (RSS Limited)
1.05	Jan. 10, 2009	<ul style="list-style-type: none"> ▶ Modified: 1.2.2 Memory Mode — Send Data behavior
1.04	Dec. 11, 2008	<ul style="list-style-type: none"> ▶ Modified: 1.3.2 Good Read LED Duration — Step 2 should be 150 milliseconds ▶ Modified: 5.6 Multi-Barcode Editor — 4-digit length excludes prefix, suffix, length code, etc. ▶ Modified: 6.2.3 Define Data Criteria — Data length includes prefix, suffix, length code, etc.
1.03	Nov. 14, 2008	<ul style="list-style-type: none"> ▶ New: Quick Start — Flowchart ▶ New: 1.3.2 Good Read LED Duration ▶ Modified: 2.1.2 Reset Connection — Restore System Defaults will clear the connection record as well ▶ Modified: 5.6 Multi-Barcode Editor — Reset scan mode to “Laser” ▶ Modified: Host Serial Commands — adds D, E commands
1.02	Sep. 17, 2008	<ul style="list-style-type: none"> ▶ Modified: Product Highlights — Transmit buffer should be 1 KB ▶ Modified: Specifications — updated
1.01	July 23, 2008	<ul style="list-style-type: none"> ▶ Modified: 1.2.1 Transmit Buffer ▶ Modified: Specifications — BT coverage (line-of-sight) up to 10 meters
1.00	May 26, 2008	Initial release

CONTENTS

- IMPORTANT NOTICES- 3 -**
 - For USA..... - 3 -
 - For Canada..... - 3 -
 - For Hand-held Product with RF Functions..... - 4 -
 - Safety Precautions - 4 -
 - Care & Maintenance..... - 4 -
- RELEASE NOTES- 5 -**
- INTRODUCTION..... 1**
 - Getting Familiarized with 1660/1661 and 3610..... 2
 - Installing Batteries to 1660/1661..... 2
 - Charging the Battery for 1661 3
 - Charging the Battery via Charger..... 4
 - Using 3610..... 5
 - Inside the Package..... 6
 - Product Highlights 6
 - Symbologies Supported..... 7
- QUICK START..... 9**
 - Enter Configuration Mode..... 11
 - Exit Configuration Mode..... 11
 - Default Settings 12
 - Save User Settings as Defaults..... 12
 - Restore User Defaults..... 12
 - Restore System Defaults..... 12
 - Read a Setup Barcode 13
 - Configure Parameters..... 13
 - List the Current Settings 17
 - Create One-Scan Setup Barcodes..... 19
- UNDERSTANDING THE BARCODE SCANNER 21**
 - 1.1 Battery..... 21
 - 1.1.1 How to Operate the Scanner..... 21
 - 1.1.2 Auto Power Off & Power-Saving 23
 - 1.1.3 Power Level (1661)..... 25
 - 1.2 Memory..... 26
 - 1.2.1 Free Memory 26
 - 1.2.2 Transmit Buffer 26
 - 1.2.3 Memory Mode..... 27
 - 1.3 LED Indicator..... 30

1.3.1 Good Read LED.....	31
1.3.2 Good Read LED Duration.....	31
1.4 Beeper.....	32
1.4.1 Beeper Volume.....	33
1.4.2 Good Read Beep.....	34
1.4.3 Low Battery Alarm (1660).....	35
1.4.4 Low Battery Alarm (1661).....	35
1.5 Send "NR" to Host.....	36
1.6 Scan Modes.....	37
1.6.1 Continuous Mode.....	38
1.6.2 Test Mode.....	38
1.6.3 Laser Mode.....	39
1.6.4 Auto Off Mode.....	39
1.6.5 Auto Power Off Mode.....	39
1.6.6 Alternate Mode.....	40
1.6.7 Aiming Mode.....	40
1.6.8 Multi-Barcode Mode.....	41
1.7 Scanning Timeout.....	42
1.8 Delay between Re-read.....	43
1.9 Read Redundancy for All Symbologies.....	44
1.10 Addon Security for UPC/EAN Barcodes.....	45
1.11 Negative Barcodes.....	46
1.12 Effective Decoding Area.....	47
1.12.1 Positioning Window.....	47
1.12.2 Adjusting Window.....	48
1.13 1661 Using Direct USB Cable.....	49
1.13.1 Direct USB Interface.....	49
1.13.2 Disable Direct USB Interface.....	49
1.14 Hardware Reset.....	50
1.14.1 Restore System Defaults.....	50
1.14.2 Reset Connection.....	50
1.14.3 Disable Hardware Reset.....	51
SELECTING OUTPUT INTERFACE.....	53
2.1 BT HID.....	54
2.1.1 Activate BT HID & Select Keyboard Type.....	55
2.1.2 Reset Connection.....	56
2.1.3 Keyboard Settings.....	57
2.1.4 Inter-Character Delay.....	64
2.1.5 Inter-Function Delay.....	64
2.1.6 HID Character Transmit Mode.....	65
2.1.7 Keypad Support for iPhone/iPad.....	65
2.1.8 Transmit Speed.....	66
2.1.9 BT HID Slave/Master Switching.....	66
2.1.10 BT HID Auto-Reconnection (1661 only).....	66
2.2 BT SPP Slave.....	67

2.2.1 Activate BT SPP Slave Mode.....	67
2.2.2 Inter-Function Delay	67
2.2.3 ACK/NAK Timeout	68
2.3 BT SPP Master	69
2.3.1 Activate BT SPP Master Mode.....	69
2.3.2 Inter-Function Delay	71
2.3.3 ACK/NAK Timeout	72
2.3.4 Switch between Master/Slave Mode	72
2.4 USB HID via 3610	73
2.4.1 Activate USB HID & Select Keyboard Type	74
2.4.2 Keyboard Settings.....	75
2.4.3 Inter-Character Delay.....	82
2.4.4 Inter-Function Delay	82
2.4.5 HID Character Transmit Mode.....	83
2.5 USB Virtual COM via 3610	84
2.5.1 Activate USB Virtual COM.....	84
2.5.2 Activate USB Virtual COM_CDC	84
2.5.3 Inter-Function Delay	84
2.5.4 ACK/NAK Timeout	85
2.6 Direct USB HID (1661 Memory Mode Only).....	86
2.6.1 Activate USB HID & Select Keyboard Type	87
2.6.2 Keyboard Settings.....	88
2.6.3 Inter-Character Delay.....	95
2.6.4 Inter-Function Delay	95
2.6.5 HID Character Transmit Mode.....	96
2.7 Direct USB Virtual COM (1661 Memory Mode Only).....	97
2.7.1 Activate USB Virtual COM.....	97
2.7.2 Inter-Function Delay	97
2.7.3 ACK/NAK Timeout	98
SETTING UP A WPAN CONNECTION.....	99
3.1 Connecting via 3610.....	100
3.1.1 Connect to 3610	100
3.1.2 Change Interface	101
3.1.3 Configure Related Settings	102
3.2 Connecting via <i>Bluetooth</i> [®] Dongle.....	103
3.2.1 Change Interface.....	103
3.2.2 Configure Related Settings	104
3.2.3 Connect to Dongle.....	107
CHANGING SYMBOLOGY SETTINGS.....	115
4.1 Codabar	116
4.1.1 Security Level	116
4.1.2 Start/Stop Characters Selection.....	116
4.1.3 Start/Stop Transmission.....	117
4.1.4 CLSI Conversion.....	117
4.2 Code 25 – Industrial 25	118

4.2.1 Start/Stop Pattern Selection	118
4.2.2 Verify Check Digit.....	119
4.2.3 Transmit Check Digit.....	119
4.2.4 Code Length Qualification	120
4.3 Code 25 – Interleaved 25	121
4.3.1 Start/Stop Pattern Selection.....	121
4.3.2 Verify Check Digit.....	122
4.3.3 Transmit Check Digit.....	122
4.3.4 Code Length Qualification	123
4.4 Code 25 – Matrix 25.....	124
4.4.1 Start/Stop Pattern Selection.....	124
4.4.2 Verify Check Digit.....	125
4.4.3 Transmit Check Digit.....	125
4.4.4 Code Length Qualification	126
4.5 Code 39	127
4.5.1 Start/Stop Transmission.....	127
4.5.2 Verify Check Digit.....	127
4.5.3 Transmit Check Digit.....	128
4.5.4 Standard/Full ASCII Code 39.....	128
4.5.5 Security Level	128
4.6 Code 93	129
4.7 Code 128.....	129
4.7.1 Security Level	129
4.8 EAN-8.....	130
4.8.1 Convert to EAN-13	131
4.8.2 Transmit Check Digit.....	131
4.8.3 Conversion Format.....	131
4.9 EAN-13.....	132
4.9.1 ISBN Conversion.....	133
4.9.2 ISSN Conversion.....	133
4.9.3 Transmit Check Digit.....	133
4.9.4 Security Level	134
4.10 GS1-128 (EAN-128).....	135
4.10.1 Code ID Transmission.....	135
4.10.2 Field Separator (GS Character)	135
4.10.3 GS1 Formatting	136
4.11 ISBT 128.....	137
4.11.1 ISBT Concatenation	137
4.12 MSI	138
4.12.1 Verify Check Digit	138
4.12.2 Transmit Check Digit	138
4.12.3 Code Length Qualification.....	139
4.13 French Pharmacode.....	140
4.13.1 Transmit Check Digit	140
4.14 Italian Pharmacode	141
4.14.1 Transmit Check Digit	141

4.15 Plessey	142
4.15.1 Convert to UK Plessey.....	142
4.15.2 Transmit Check Digit	142
4.16 GS1 DataBar (RSS Family)	143
4.16.1 Code ID Selection	143
4.16.2 GS1 DataBar Omnidirectional (RSS-14)	144
4.16.3 GS1 DataBar Expanded (RSS Expanded).....	146
4.16.4 GS1 DataBar Limited (RSS Limited).....	147
4.16.5 Field Separator (GS Character).....	148
4.16.6 GS1 Formatting	148
4.17 Telepen.....	149
4.17.1 Telepen Output – Full ASCII/Numeric	149
4.18 UPC-A.....	150
4.18.1 Convert to EAN-13	151
4.18.2 System Number Transmission	151
4.18.3 Transmit Check Digit	151
4.19 UPC-E.....	152
4.19.1 System Number Selection	153
4.19.2 Convert to UPC-A.....	153
4.19.3 System Number Transmission	154
4.19.4 Transmit Check Digit	154
DEFINING OUTPUT FORMAT	155
5.1 Letter Case.....	155
5.2 Character Substitution.....	156
5.2.1 Select a Set for Character Substitution	157
5.2.2 Symbologies for Character Substitution (All 3 Sets).....	158
5.3 Prefix/Suffix Code.....	164
5.4 Code ID.....	165
5.4.1 Select Pre-defined Code ID	165
5.4.2 Change Code ID.....	167
5.4.3 Clear Code ID Settings.....	168
5.5 Length Code.....	169
5.6 Multi-Barcode Editor	173
5.6.1 Edit a Concatenation of Barcodes	174
5.6.2 Activate the Concatenation of Barcodes.....	175
5.7 Removal of Special Character.....	176
APPLYING FORMATS FOR DATA EDITING	177
6.1 Activating Editing Formats.....	178
6.1.1 Activate Editing Formats.....	178
6.1.2 Exclusive Data Editing.....	179
6.2 Editing Format	180
6.2.1 Select Format to Configure.....	181
6.2.2 Restore Default Format.....	182
6.3 Configuring Format — Define Data Criteria	183

6.3.1 Applicable Code Type.....	183
6.3.2 Data Length.....	190
6.3.3 Matching String & Location.....	191
6.4 Configuring Format — Define Data Field.....	192
6.4.1 Start Position.....	192
6.4.2 Field Adjustment.....	192
6.4.3 Total Number of Fields.....	193
6.4.4 Field Settings.....	194
6.4.5 Pause Field Setting.....	200
6.5 Configuring Format — Define Transmission Sequence.....	201
6.6 Programming Examples.....	203
6.6.1 Example I.....	203
6.6.2 Example II.....	204
SPECIFICATIONS.....	205
FIRMWARE UPGRADE.....	207
How to Upgrade 1660/1661 Firmware.....	207
Using 3610.....	207
Using Direct USB Virtual COM (1661 Only).....	209
Using <i>Bluetooth</i> [®] Dongle.....	210
How to Upgrade 3610 Firmware.....	212
Upgrading 3610 CPU Firmware.....	212
Upgrading 3610 USB Bridge Firmware.....	213
Upgrading 1661 USB Bridge Firmware.....	214
HOST SERIAL COMMANDS.....	217
1660/1661 Serial Commands.....	217
Example.....	218
3610 Setup Barcodes & Serial Commands.....	219
3610 Serial Commands and Equivalent Setup Barcodes.....	220
Example.....	222
KEYBOARD WEDGE TABLE.....	223
Key Type & Status.....	224
Key Type.....	224
Key Status.....	224
Example.....	225
NUMERAL SYSTEMS.....	227
Decimal System.....	227
Hexadecimal System.....	228
ASCII Table.....	229
Entering PIN Code for Authentication.....	230
Use Preset PIN.....	230
Disable Authentication or Use Random PIN.....	231

INTRODUCTION

CipherLab's small-form-factor 1660 Series Barcode Scanners are specifically designed to answer your mobile demands. The palm-sized scanners are designed to help accelerate productivity while lowering the total cost of ownership. Intensive data collection jobs are made easier with fast, accurate barcode scanning in various working environments, especially in small businesses. Integrating short-distance wireless technology to small-form-factor scanners, the scanners are ideal for carrying in your pocket, and thus give workers tether-free mobility anytime anywhere and get job done more efficiently. This line of scanners deliver data over a wireless personal network at a range of up to 10 meters and a prolonged battery life to keep business running.

Owing to the compact design, extremely low power consumption, and powerful decoding capability, the 1660 Series Barcode Scanners are the best choice for the following applications –

- ▶ Receiving in Retail
- ▶ Product labeling & Tracking
- ▶ Shelf Product Replenishment
- ▶ Mobile Point of Sale (POS)
- ▶ Mobile Inventory Management
- ▶ Order Picking & Staging
- ▶ Work-In-Process Tracking
- ▶ Material Flow Control
- ▶ Transportation & Distribution
- ▶ Warehousing
- ▶ Asset Management

This manual contains information on operating the scanner and using its features. We recommend you to keep one copy of the manual at hand for quick reference or maintenance purposes. To avoid any improper disposal or operation, please read the manual thoroughly before use.

Thank you for choosing CipherLab products!



GETTING FAMILIARIZED WITH 1660/1661 AND 3610

INSTALLING BATTERIES TO 1660/1661

- 1) Hold the scanner face down in one hand.
- 2) Press the battery lid release and slide the battery lid.
- 3) Remove the battery lid by the other hand.

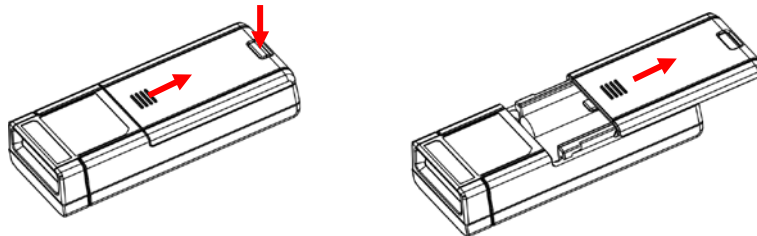

- 4) Hold the scanner still and insert the battery or batteries into the battery compartment.
 - ▶ For 1660, install two AAA Alkaline batteries into the battery compartment, each in the right direction.
- 5) Replace the battery lid and lock it firmly.
- 6) Hold down the [Power/Delete] key for about 2 seconds to turn on the scanner.

The scanner will respond with a long beep (high tone) and its LED indicator will become solid red and go off quickly.

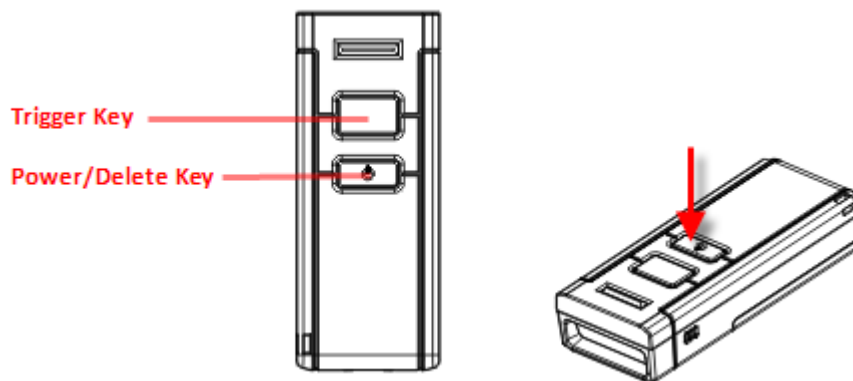

Note: (1) To turn off the scanner, press the [Power/Delete] key for 2 seconds. The scanner will respond with two short beeps (high tone) and the LED will finally become solid red. Release the key then. Otherwise, let the scanner turn off automatically in specific circumstances. Refer to settings of "[Auto Power Off](#)".
(2) For shipping and storage purposes, save the scanner and the batteries separately. This will keep the batteries in good condition for future use.



CHARGING THE BATTERY FOR 1661

The battery may not be charged to full for shipment. When you first receive the package, you will need to charge the battery to full before using the scanner. For 1661, use the Direct USB cable to connect the scanner to PC for charging. It takes approximately 4 hours to charge the battery to full. Refer to [1.13 1661 Using Direct USB Cable](#).

Note: Battery charging stops when the temperature drops below 0°C or exceeds 40°C. It is recommended to charge the battery at room temperature (18°C to 25°C) for optimal performance.

- 1) Install the battery to 1661.
- 2) Connect 1661 to your computer or notebook via the USB cable.
- 3) The scanner LED will be flashing red during charging.

When the charging is done, the LED will turn off.

When charging error occurs, the LED will turn solid red. For example, a bad or missing battery.



CHARGING THE BATTERY VIA CHARGER

The battery charger is provided for charging the battery only. You may purchase the charger separately. It takes approximately 3 hours to charge the battery to full.

Note: Battery charging stops when the temperature drops below 0°C or exceeds 40°C. It is recommended to charge the battery at room temperature (18°C to 25°C) for optimal performance.

- 1) Insert the battery.
- 2) Connect the power supply cord to the charger.
- 3) Connect the other end of the power cord to a suitable power outlet.

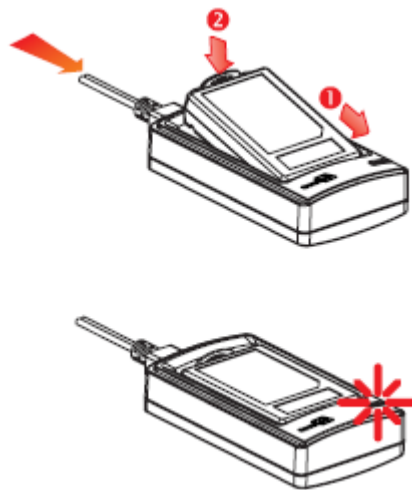

Status LED		Meaning
Red, solid	---	Charger power ON (LED on for 0.5 second)
Red, solid	---	Charging battery
---	Green, solid	Charging done
Red, solid	Green, solid	Pre-charging when battery voltage under 3V (Typical)
---	---	Power or battery not ready



USING 3610

The BT Transponder (3610) is specifically designed for the scanner to communicate with a host computer wirelessly. The connection between the scanners and 3610 is made easy and reliable. Refer to [3.1.1 Connect to 3610](#).

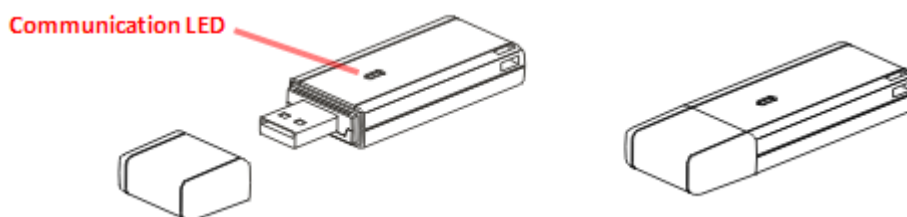

There is one LED indicator provided for communications status.

Communication LED		Meaning
---	Blue, solid	Initialize
Red, solid	---	Failed to establish a USB connection
Red, solid	Blue, flashing	Serial command mode with USB Virtual COM: wait 3 seconds for starting a serial command
Red, flashing	Blue, flashing	Serial command mode with USB HID: wait 3 seconds for pressing [Num Lock] or [Caps Lock] 5 times via keyboard
---	Blue, flashing	Wait for connection request from the scanner (Slow flash at 0.5 Hz)
---	Blue, flashing	Connected with the scanner (Fast flash at 1 Hz)
Red, solid	Blue, flashing	Failed to send data to host via USB Virtual COM (Fast flash at 1 Hz)
Red, flashing	---	Enter Download Mode



INSIDE THE PACKAGE

The items included in the package may be different, depending on your order. Save the box and packaging material for future use in case you need to store or ship the scanner.

- ▶ Barcode Scanner (1660 or 1661)
- ▶ BT Transponder (3610)
- ▶ Rechargeable Li-ion battery (for 1661)
- ▶ Direct USB Cable (for 1661)

PRODUCT HIGHLIGHTS

- ▶ Small-form-factor and built tough to survive drop test
- ▶ Extremely low power consumption
- ▶ Firmware upgradeable
- ▶ Supports most popular barcode symbologies, including GS1-128 (EAN-128), GS1 DataBar (RSS) etc.
- ▶ Supports negative barcodes
- ▶ Supports different scan modes, including Aiming Mode and Multi-Barcode Mode
- ▶ LED indicator and beeper for status verification
- ▶ Beeping tone and duration programmable for Good Read
- ▶ 1660: 256 KB flash memory for Memory Mode operation, storing up to 16,384 scans based on EAN-13 barcodes
- ▶ 1661: 512 KB flash memory for Memory Mode operation, storing up to 32,768 scans based on EAN-13 barcodes
- ▶ Provides up to 1 KB SRAM for reserve buffer while getting out of range over a wireless personal area network (WPAN), storing up to 64 scans based on EAN-13 barcodes
- ▶ Capable of transmitting scanned data, emulating a serial cable (BT SPP) or as keyboard input (BT HID), to a notebook computer or PDA with *Bluetooth*[®] wireless technology
- ▶ Supports BT SPP Slave & Master Mode operations
- ▶ Programmable parameters including data output format, editing format, symbologies, etc.
- ▶ Easy configuration through ScanMaster
- ▶ Easy connection through CipherConnect, readily available via online marketplace for mobile devices running on Android 2.x, BlackBerry 5.x, or Windows Mobile 6.x



SYMBOLOGIES SUPPORTED

Most of the popular barcode symbologies are supported, as listed below. Each can be individually enabled or disabled. The scanner will automatically discriminate and recognize all the symbologies that are enabled. Refer to [Chapter 4 Changing Symbology Settings](#) for details of each symbology.

Symbologies Supported: Enable/Disable		Default	
Codabar		Enabled	
Code 93		Enabled	
MSI			Disabled
Plessey			Disabled
Telepen			Disabled
Code 128	Code 128	Enabled	
	GS1-128 (EAN-128)	Enabled	
	ISBT 128	Enabled	
Code 2 of 5	Industrial 25	Enabled	
	Interleaved 25	Enabled	
	Matrix 25		Disabled
Code 3 of 9	Code 39	Enabled	
	Italian Pharmacode		Disabled
	French Pharmacode		Disabled
EAN/UPC	EAN-8	Enabled	
	EAN-8 Addon 2		Disabled
	EAN-8 Addon 5		Disabled
	EAN-13	Enabled	
	EAN-13 & UPC-A Addon 2		Disabled
	EAN-13 & UPC-A Addon 5		Disabled
	ISBN		Disabled
	UPC-E0	Enabled	
	UPC-E1		Disabled
	UPC-E Addon 2		Disabled
	UPC-E Addon 5		Disabled
UPC-A	Enabled		



GS1 DataBar (RSS)	GS1 DataBar Omnidirectional (RSS-14)		Disabled
	GS1 DataBar Truncated		Disabled
	GS1 DataBar Stacked		Disabled
	GS1 DataBar Stacked Omnidirectional		Disabled
	GS1 DataBar Limited (RSS Limited)		Disabled
	GS1 DataBar Expanded (RSS Expanded)		Disabled
	GS1 DataBar Expanded Stacked		Disabled



QUICK START

The configuration of the scanner can be done by reading the setup barcodes contained in this manual or via the *ScanMaster* software.

This section describes the procedure of configuring the scanner by reading the setup barcodes and provides some examples for demonstration.

Configuration Mode

1. Hold down the [Power/Delete] key for about 2 seconds to turn on the scanner. It will respond with a long beep and its LED will come on-off shortly.
2. Have the scanner read the "Enter Setup" barcode. It will respond with six beeps and its LED indicator will become flashing red after reading the barcode.
3. Have the scanner read more setup barcodes... Most of the setup barcodes are normal, and the scanner will respond with two beeps (low-high tone). For special setup barcodes, it requires reading more than one setup barcode to complete the setting.
4. Have the scanner read the "Update" or "Abort" barcode. It will respond with six beeps and its LED indicator will become flashing red after reading the barcode.
5. The scanner will restart automatically upon reading the "Update" or "Abort" barcode. It will respond with a long beep and its LED will come on-off shortly.



Note: Refer to [Appendix II Host Serial Commands](#) for how to configure the 3610 dongle by having the scanner read 3610-related setup barcodes or using serial commands.



Working Mode

Upon powering up, the scanner will try to establish a connection with 3610 or a computer with *Bluetooth*[®] wireless technology. Refer to [Chapter 3 – Setting up a WPAN Connection](#) for details. The connection between the scanners and 3610 is made easy and reliable. Now, it also supports BT SPP Master Mode as an alternative. Refer to [2.3 BT SPP Master](#).



Note: If USB Virtual COM or BT SPP is selected for output interface, the host can directly send serial commands to configure the scanner. For example, run HyperTerminal.exe and type the 6-digit command located under each setup barcode. Refer to [Appendix II Host Serial Commands](#).



ENTER CONFIGURATION MODE

For the scanner to enter the configuration mode, you must have it read the "Enter Setup" barcode, which can be located at the bottom of almost every even page of this manual.

- ▶ The scanner will respond with six beeps and its LED indicator will become flashing red after reading the barcode.

Enter Setup



For configuring scanner parameters, see "Read a Setup Barcode" below.

EXIT CONFIGURATION MODE

For the scanner to save settings and exit the configuration mode, you must have it read the "Update" barcode, which can be located at the bottom of almost every odd page of this manual. If you want to exit the configuration mode without saving any changes, have the scanner read the "Abort" barcode instead.

- ▶ Just like reading the "Enter Setup" barcode, the scanner will respond with six beeps and its LED indicator will become flashing red after reading the barcode. Wait for a few seconds for the scanner to restart itself.

Update



109999

Abort



109998



DEFAULT SETTINGS

SAVE USER SETTINGS AS DEFAULTS

For the scanner to keep the customized settings as user defaults, you must have it read the “Save as User Defaults” barcode. This is a normal setup barcode, and the scanner will respond with two beeps (low-high tone).

- ▶ After reading the “Update” barcode, the current settings will be saved as user defaults.

Save as User
Defaults



RESTORE USER DEFAULTS

For the scanner to restore the user defaults, which you have saved earlier, you must have it read the “Restore User Defaults” barcode. This is a normal setup barcode, and the scanner will respond with two beeps (low-high tone).

- ▶ After reading the “Update” barcode, all the parameters of the scanner will return to their customized values.

Restore User
Defaults



RESTORE SYSTEM DEFAULTS

For the scanner to restore the factory defaults, you must have it read the “Restore System Defaults” barcode. This is a normal setup barcode, and the scanner will respond with two beeps (low-high tone). After reading the “Update” barcode, all the parameters of the scanner will return to their default values. The current connection record will be cleared as well. Refer to [1.14.1 Restore System Defaults](#) for the key combination used to restore defaults during operation.

For 3610 to restore factory defaults, refer to [3610 Setup Barcodes](#) & Serial Commands.

Restore System
Defaults



Note: The system default value (if there is) for each setting is indicated by an asterisk “*”.



READ A SETUP BARCODE

CONFIGURE PARAMETERS

For most of the scanner parameters, only one read is required to set them to new values. The scanner will respond with two beeps (low-high tone) when each parameter is set successfully. Refer to [Create One-Scan Setup Barcodes](#).



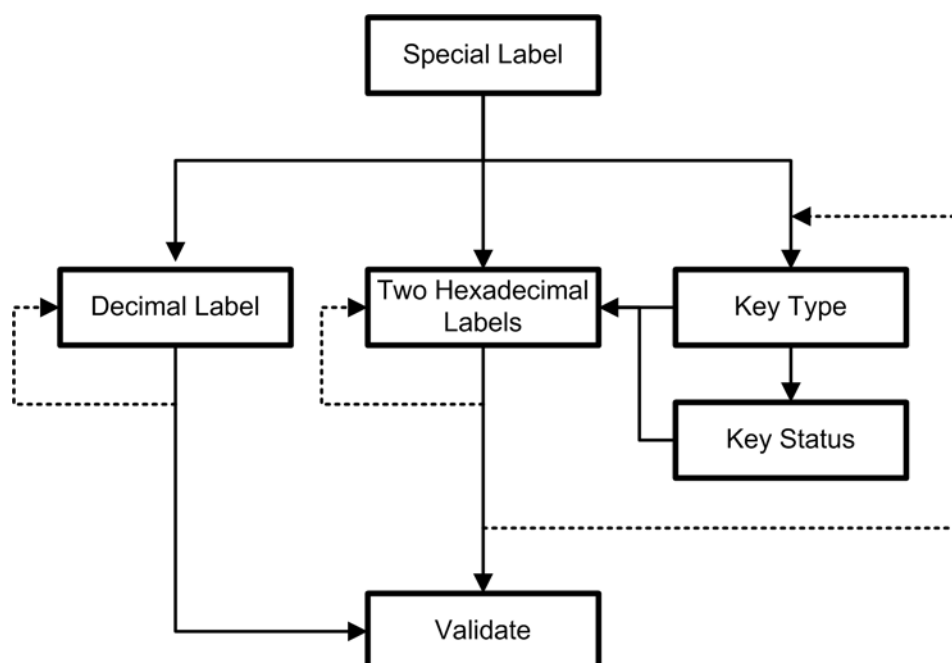

But for a number of special parameters, multiple reads are required to complete the setting. In this case, the scanner will respond with a short beep to indicate it needs to read more setup barcodes. These special parameters may require reading one or more setup barcodes, such as

- ▶ Numeric barcodes, say, for keyboard type, inter-character delay, length qualification
- ▶ Hexadecimal barcodes, say, for character strings as prefix, suffix, etc.
- ▶ When “BT HID” or “USB HID” is configured for interface, Key Type and Key Status will then become applicable. You may decide whether or not to change key status when “Normal Key” is selected for Key Type.

To complete the configuration of these special parameters, it requires reading the “Validate” barcode, and the scanner will respond with two beeps (low-high tone) to indicate the input values are validated.









The example below shows how to save your settings as “User Default” so that you may restore user defaults at a later time:

Steps	Action	User Feedback if Successful
1	Power on the scanner...	The scanner will respond with a long beep (high tone) and its LED indicator will become solid red and go off quickly.
2	Enter the Configuration Mode...	The scanner will respond with six beeps (high-low tone repeats three times), and its LED indicator will be flashing red.
3	Read a Setup barcode... For example,	The scanner will respond with two beeps (low-high tone) if reading a normal setup barcode.
<p style="text-align: center;">Enter Setup</p>  <p style="text-align: center;">*Enable Industrial 25</p>  <p style="text-align: center;">100307</p> <p style="text-align: center;">Save as User Default</p>  <p style="text-align: center;">109986</p>		
4	Exit the Configuration Mode...	Same as for <i>Enter the Configuration Mode</i> .
<p style="text-align: center;">Update Abort</p>  <p style="text-align: center;">109999 OR 109998</p> 		
5	The scanner will automatically restart itself...	Same as for <i>Power on the scanner</i> .
*	When any configuration error occurs...	The scanner will respond with one long beep (low tone).







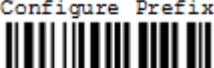

The example below shows how to set numeric parameters:

Steps	Action	User Feedback if Successful
1	Power on the scanner...	The scanner will respond with a long beep (high tone) and its LED indicator will become solid red and go off quickly.
2	Enter the Configuration Mode...	The scanner will respond with six beeps (high-low tone repeats three times), and its LED indicator will become flashing red.
3	Read a Setup barcode... For example,	The scanner will respond with two beeps (low-high tone) if reading a normal setup barcode.
<div style="border: 1px solid red; padding: 2px; display: inline-block;">Normal setup barcode</div>	<p style="text-align: center;">*Enable Interleaved 25</p> <p style="text-align: center;">Enter Setup</p>  <p style="text-align: center;">100309</p>	
	<div style="border: 1px solid red; padding: 2px; display: inline-block;">Normal setup barcode</div>	<p style="text-align: center;">Enable Fixed Length(s) ...</p>  <p style="text-align: center;">100604</p>
<div style="border: 1px solid red; padding: 2px; display: inline-block;">Special setup barcode</div>		<p style="text-align: center;">Max. Length (*126) Or Fixed Length 1</p>  <p style="text-align: center;">100606</p>
	<div style="border: 1px solid red; padding: 2px; display: inline-block;">Decimal barcodes</div>	<p style="text-align: center;">1</p>  <p style="text-align: center;">109901</p>
<p style="text-align: center;">5</p>  <p style="text-align: center;">109905</p>		
<p style="text-align: center;">Validate</p>  <p style="text-align: center;">109994</p>		The scanner will respond with two beeps (low-high tone) when the input values are validated.
4	Exit the Configuration Mode...	Same as for <i>Enter the Configuration Mode</i> .
5	The scanner will automatically restart itself...	Same as for <i>Power on the scanner</i> .



The example below shows how to set string parameters:

Steps	Action	User Feedback if Successful
1	Power on the scanner...	The scanner will respond with a long beep (high tone) and its LED indicator will become solid red and go off quickly.
2	Enter the Configuration Mode...	The scanner will respond with six beeps (high-low tone repeats three times), and its LED indicator will become flashing red.
3	Read a Setup barcode... For example,	The scanner will respond with one short beep if reading a special setup barcode such as "Prefix Code", indicating the setup requires reading more barcodes.
<div style="border: 1px solid red; padding: 2px; display: inline-block;">Special setup barcodes</div>	<p style="text-align: center;">Configure Prefix</p>  <p style="text-align: center;">101230</p>	<p>When "BT HID" or "USB HID" is configured for interface, Key Type and Key Status will then become applicable. You may decide whether or not to change key status when "Normal Key" is selected for Key Type.</p> <p>▶ Refer to Appendix III</p>
	<p style="text-align: center;">*Normal</p>  <p style="text-align: center;">109926</p>	
	<p style="text-align: center;">Add Left Alt</p>  <p style="text-align: center;">109932</p>	
<div style="border: 1px solid red; padding: 2px; display: inline-block;">Hexadecimal barcodes</div>	<p style="text-align: center;">2</p>  <p style="text-align: center;">109902</p>	<p>Read the "Hexadecimal Value" barcodes for the desired character string. For example, read "2" and "B" for the scanner to prefix the character "+".</p> <p>▶ Refer to Appendix IV "Hexadecimal System"</p>
	<p style="text-align: center;">B</p>  <p style="text-align: center;">109911</p>	
	<p style="text-align: center;">Validate</p>  <p style="text-align: center;">109994</p>	
4	Exit the Configuration Mode...	Same as for <i>Enter the Configuration Mode</i> .
5	The scanner will automatically restart itself...	Same as for <i>Power on the scanner</i> .



LIST THE CURRENT SETTINGS

The current settings of all scanner parameters can be sent to the host computer for user inspection. The listing includes pages as shown below. You can select the page of interest by having the scanner read the "List Page x" barcode. The scanner will respond with two beeps (low-high tone) and send the selected page to the host immediately.

List settings regarding Firmware Version, Serial Number, Interface, Buzzer, and Other Scanner Parameters

List Page 1



List settings regarding Prefix, Suffix, and Length Code Setting

List Page 2



List settings regarding Code ID

List Page 3



List settings regarding: Readable Symbologies

List Page 4



List settings regarding Symbology Parameters (1/3)

List Page 5



List settings regarding Symbology Parameters (2/3)

List Page 6



List settings regarding Symbology Parameters (3/3)

List Page 7



List settings regarding Editing Format 1

List Page 8



List settings regarding Editing Format 2

List Page 9



List settings regarding Editing Format 3

List Page 10



List settings regarding Editing Format 4

List Page 11



109937

List settings regarding Editing Format 5

List Page 12



109938



CREATE ONE-SCAN SETUP BARCODES

The fact is most of the scanner parameters require only one read for setting new values. To facilitate configuring the scanner, you may create One-Scan setup barcodes for use.

The requirements of a One-Scan setup barcode are:

- ▶ a prefix of the "#@" characters
- ▶ the six digits of command parameters
- ▶ a suffix of the "#" character

For example, the scanner needs reading three setup barcodes for the command parameter "109952" to take effect:

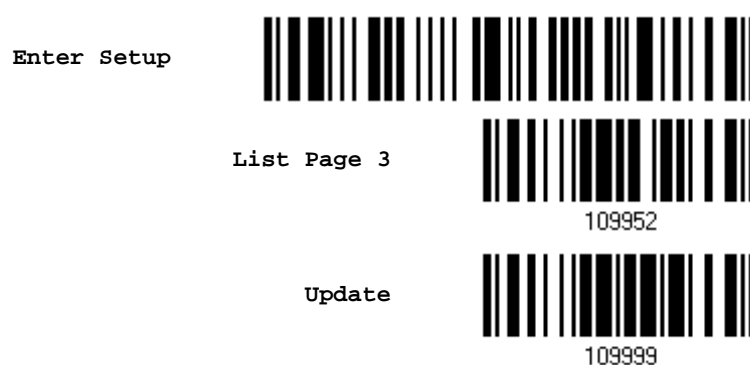

Now, it requires only one read:



Note: The scanner will restart automatically upon reading the One-Scan setup barcode for (1) changing the interface or (2) setting memory mode, enable or disable. It will respond with a long beep and its LED will come on-off shortly.





UNDERSTANDING THE BARCODE SCANNER

This chapter explains the features and usage of the barcode scanner.

IN THIS CHAPTER

1.1 Battery	21
1.2 Memory	26
1.3 LED Indicator	30
1.4 Beeper.....	32
1.5 Send "NR" to Host.....	36
1.6 Scan Modes.....	37
1.7 Scanner Time-out	42
1.8 Delay between Re-read.....	43
1.9 Read Redundancy for All Symbologies	44
1.10 Addon Security for UPC/EAN Barcodes	45
1.11 Negative Barcodes.....	46
1.12 Effective Decoding Area	47
1.13 1661 Using Direct USB Cable	49
1.14 Hardware Reset	50

1.1 BATTERY

The scanner is battery-powered: 1660 uses two AAA Alkaline batteries, while 1661 uses a rechargeable 3.7 V/850 mAh Li-ion battery. For intensive data collection, you may prepare spare battery or batteries for non-stop operation.

Note: (1) The rechargeable battery for 1661 may not be charged to full for shipment. We suggest charging it to full before use.
(2) The scanner can be configured to save battery power. Refer to settings of "[Auto Power Off & Power-Saving](#)", "[Sniff Mode](#)", as well as "[Low Battery Alarm](#)".

1.1.1 HOW TO OPERATE THE SCANNER

Turn on the scanner...

Press the [Power/Delete] key for about 2 seconds. The scanner will respond with a long beep (high tone), and its LED indicator will become solid red and go off quickly.

Turn off the scanner...

Press the [Power/Delete] key for about 2 seconds. The scanner will respond with two short beeps (high tone) and the LED will finally become solid red. Release the key then. Otherwise, let the scanner turn off automatically in specific circumstances.



Delete the last collected data when in memory mode ...

Press the [Power/Delete] key. The scanner will respond with two short beeps (high tone) and the LED will become solid red. Before the LED goes off (within 1 second), press the [Power/Delete] key again to confirm the deletion.

Enable/Disable the [Delete] key function

Scan the barcode below to enable/disable the [Delete] key. By default, users can press the [Power/Delete] key to delete data. If the function is disabled, pressing the key to delete data is not allowed.

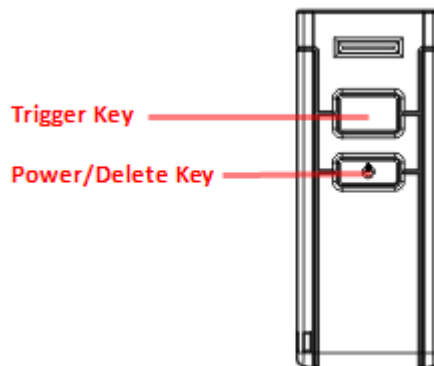

1.1.2 AUTO POWER OFF & POWER-SAVING

The scanner will stay active at power-on, which may be followed by a transition from full CPU speed to low CPU speed (Power-Saving) to auto shutdown (Auto Power Off).

- ▶ Power-Saving (1~254 min.; 0= Disable): By default, it is set to stand by at full-speed for 2 minutes before it enters low-speed mode. If this feature is not desired, set it to 0.
- ▶ Auto Power Off (1~254 min.; 0= Disable): By default, it is set to automatically shut down after 10 minutes. If this feature is not desired, set it to 0.

Note: The Power-Saving setting will not take effect when a WPAN connection has been established successfully, via BT HID or SPP.

Before establishing a WPAN connection successfully...

1. The scanner will stay active for a specified period of time (2 minutes by default) for the following scenarios. Its CPU is running at full speed, and the LED is flashing blue (On/Off ratio 0.5 s: 0.5 s).
 - (a) waiting for a connection request from the host (BT SPP Slave Mode)
 - (b) trying to connect to the host (BT HID or BT SPP Master Mode)
 - (c) trying to connect to 3610
2. If it fails to connect within 2 minutes, the scanner will become inactive to save power for the remaining period of time (the specified value minus 2 minutes). Its CPU is running at low speed, and the LED is flashing red (On/Off ratio 0.3 s: 2.5 s).

Press the [Trigger] key to wake up the scanner when it becomes inactive, and the scanner will stay active again.
3. If it fails to connect again and again, and finally stays inactive until the specified time interval for Auto Power Off has elapsed, the scanner will automatically turn off in order to conserve battery power.

Hold down the [Power/Delete] key for about 2 seconds to turn it on.

Note: For scenarios (a) and (b) in step 1, on your computer you may need to search for the scanner again.



After establishing a WPAN connection successfully...

1. Once a WPAN connection is established successfully, the scanner will stay active for a specified period of time (2 minutes by default) for data transmission. Its CPU is running at full speed, and the LED is flashing blue (On/Off ratio 0.02 s: 3 s).
2. If it is idle within 2 minutes, the scanner will become inactive to save power for the remaining period of time (the specified value minus 2 minutes). Its CPU is running at low speed, and the LED is flashing red (On/Off ratio 0.3 s: 2.5 s).

Press the [Trigger] key to wake up the scanner when it becomes inactive, and the scanner will stay active again.

- ▶ For BT HID or SPP, there is no transition from full CPU speed to low CPU speed. However, when connecting with 3610, the scanner will go through the transition in order to save power.
3. If it is idle and finally stays inactive until the specified time interval for Auto Power Off has elapsed, the scanner will automatically turn off in order to conserve battery power. You will hear three short beeps, tone descending from high to low.

Hold down the [Power/Delete] key for about 2 seconds to turn it on.

- ▶ For BT HID, the scanner will resume connection with the host upon powering on again, as long as the host application is running. You will hear three short beeps, tone ascending from low to high. If the scanner fails to resume connection, it will try every 5 seconds to re-connect to the host unless you have the scanner read the "Reset Connection" barcode.
- ▶ For BT SPP Slave Mode, the scanner must wait for the host to re-connect.
- ▶ For BT SPP Master Mode, the scanner will resume connection with the host upon powering on again, as long as the host application is running. You will hear three short beeps, tone ascending from low to high. If the scanner fails to resume connection, it will try every 5 seconds to re-connect to the host unless you have the scanner read the "Reset Connection" or "Restore System Defaults" barcode.
- ▶ With the use of 3610, the scanner will try re-connecting to 3610 unless you turn off the scanner.



Auto Off after
0~254 min. (*10)



101000

- 1) Read the barcode above to specify the time interval before the scanner automatically turns off.
- 2) Read the "[Decimal Value](#)" barcode on page 227. For example, read "1" and "5" for the scanner to automatically turn off after being idle for 15 minutes.
- 3) Read the "Validate" barcode on the same page to complete this setting.

Note: Auto Power Off will not take effect when the scanner is in the configuration mode.

Power-Saving after
0~254 min. (*2)



101021

- 1) Read the barcode above to specify the time interval before the scanner enters low-speed mode.
- 2) Read the "[Decimal Value](#)" barcode on page 227. For example, read "5" for the scanner to enter low-speed mode after being idle for 5 minutes.
- 3) Read the "Validate" barcode on the same page to complete this setting.

Note: Power-Saving will not take effect when one of the following conditions is met:

- (1) the scanner has already established a BT HID/SPP connection,
 - (2) the scanner is in the configuration mode,
 - (3) the scan mode is set to Test, Continuous or Alternate Mode, or
 - (4) the setting value of Power-Saving is greater than that of Auto Power Off.
-

1.1.3 POWER LEVEL (1661)

Scan the barcode below to get the battery capacity information with each increment of 20 in percentage terms.

Remaining Battery
Capacity



109930



1.2 MEMORY

The collected data can be sent back to a host computer one by one via the WPAN connection or stored in flash memory when the scanner is set to Memory mode.

1.2.1 FREE MEMORY

You can scan the barcode below to show the available capacity of the flash memory in percentage terms.

Available Memory



1.2.2 TRANSMIT BUFFER

By default, transmit buffer is enabled and for use when the scanner is out of range. Upon reading a barcode successfully within range, the scanner responds with one short beep (high tone) and its LED indicator becomes solid green and goes off quickly. However, the host computer may not receive the data immediately if getting out of range. With the 1 KB transmit buffer, the scanner can ignore the transmission status and keep on reading barcodes until the buffer is full.

When transmit buffer is enabled...

If the scanner is out of range, it will respond with two short beeps, high-low tone, upon reading a barcode successfully.

When transmit buffer is full, the scanner will respond with one long beep (low tone) and its LED indicator will become solid red and go off quickly. You are advised to get back to range.

When transmit buffer is disabled...

If the scanner is out of range, it will respond with one long beep (low tone) and its LED indicator will become solid red and go off quickly. You are advised to get back to range.

*Enable



Disable



Note: The 1 KB transmit buffer on the scanner can hold as many as 64 scans based on EAN-13 barcodes. Data will be cleared out once the scanner is turned off or running out of battery power!



1.2.3 MEMORY MODE

When the scanner is in memory mode, it means any real-time connection established with the host is disabled.

- ▶ The 1660 scanner keeps 256 KB flash memory for memory mode operation, which can store up to 16,384 scans based on EAN-13 barcodes.
- ▶ The 1661 scanner keeps 512 KB flash memory for memory mode operation, which can store up to 32,768 scans based on EAN-13 barcodes.



Warning: No real-time connection is allowed unless the memory mode is disabled.

Memory Data Delay

You may set a delay between each data record while transmitting data back to the host.





Send Data

When the memory is used up, the scanner will respond with two short beeps (high-low tone) as a warning. You are advised to send data to the host immediately by having the scanner read the “Send Data” barcode below.

- ▶ For 1660, it will temporarily resume the previous WPAN connection with the host.
- ▶ For 1661, it can send data via “Direct USB” interface once the computer has found the USB connection. Refer to [1.13 1661 Using Direct USB Cable](#). Because the time-out value is set to 0 by default, you must connect the cable before having the scanner read the “Send Data” barcode. Otherwise, the scanner will try to temporarily resume the previous WPAN connection with the host, if there is any.



Send Data Time-out

For 1661, if a time-out value other than zero is given, it will first try to send data via “Direct USB” interface within the specified period of time. You must connect the cable before it times out. When the attempt fails, it will try to temporarily resume the previous WPAN connection with the host, if there is any.

If 1661 has never been connected to the host wirelessly, it will not be able to send data until you connect the Direct USB cable!

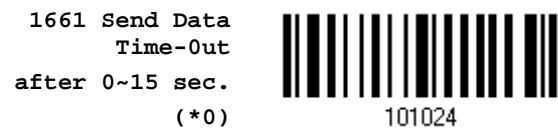

Clear Data & Confirm

Even though data has been sent back to the host, the flash memory is still occupied unless you erase the memory by having the scanner read two barcodes – “Clear Data” and “Confirm”.

1. Read the “Clear Data” barcode to clear the flash memory.
2. Read the “Confirm” barcode to confirm the action.



Record Count of Memory

Enabling

You can scan the barcodes below to confirm the data record count of the flash memory.

After reading the "Enter Setup" barcode, read "Get Authorization" and "Enable" barcodes to enable this function. Certainly, you have to read the "Update" barcode to complete this Enable procedure.

Get Authorization



Enable



Then read the "Enter Setup", "Show Data Record Count of Memory", and "Update" barcodes in sequence to show the data record count.

Show Data Record
Count of Memory



Note: It's necessary to "enable" this function for the first time you want to get the record count information. Next time you are free to read the "Show Data Record Count of Memory" barcode directly without having to "enable" it again.

Disabling

If you want to disable this function, please read the "Enter Setup", "Get Authorization", "Disable", and "Update" barcodes in sequence.

Get Authorization



Disable



Note: With the "Record Count of Memory" function enabled, the number of data records will be counted up from zero when you start to collect data. Keep it in mind that the existing data records you collected before enabling this function won't be cleared. Thus the record count you get will not include those existing data records.



1.3 LED INDICATOR

The triple-color LED on top of the scanner is used to provide user feedback. For example, the LED becomes solid red and goes off quickly upon powering on or running out of transmit buffer. You may tell the difference by the beeps – you will hear a long beep of high tone when powering on the scanner, and a long beep of low tone when the transmit buffer becomes full.

Scanner LED			Meaning
Red, on-off	---	---	<ul style="list-style-type: none"> ▶ Power on, with one long beep (high tone, LED on for 1 second) ▶ Data saved to buffer when transmit buffer is enabled and the scanner is out of range, with two short beeps (high-low tone) ▶ Transmit buffer full, with one long beep (low tone) ▶ Transmit buffer disabled, with one long beep (low tone) ▶ Delete the last collected data in memory mode, with two short beeps (high tone, LED on for 1 second) ▶ Memory full in memory mode, with two short beeps (high-low tone)
Red, flashing	---	---	<ul style="list-style-type: none"> ▶ Flashing red (On/Off ratio 0.3 s: 2.5 s) indicates the scanner is inactive and its CPU running at low speed to save power (because no WPAN connection is established after waiting for two minutes) ▶ Configuration Mode (On/Off ratio 0.5 s: 0.5 s)
---	---	Green, on-off	Good Read, with one short beep (high tone) and beeper pitch and duration programmable
---	Blue, flashing	---	<p>First, flashing blue (On/Off ratio 0.5 s: 0.5 s) for two minutes indicates the scanner is waiting for connection, and goes off if no connection is established, then flashing red (On/Off ratio 0.3 s: 2.5 s) indicates the scanner is inactive.</p> <p>It is ready for connection only while the LED is flashing blue —</p> <ul style="list-style-type: none"> ▶ SPP Slave: waiting host to connect ▶ HID or SPP Master: trying to connect to host ▶ Using 3610: trying to connect to 3610
---	Blue, flashing	---	Flashing blue (On/Off ratio 0.1 s: 0.1 s) indicates the scanner receives a PIN code request from host (flashing more quickly than waiting connection).
---	Blue, flashing	---	Flashing blue (On/Off ratio 0.02 s: 3 s) indicates the scanner has established a WPAN connection successfully.
---	Blue, flashing	Green, flashing	Flashing blue and green (On/Off ratio 0.1 s: 0.1 s) indicates an error occurs while entering the PIN code. Press the [Trigger] key to get ready for re-connecting.



1.3.1 GOOD READ LED

*Enable
Good Read LED



Disable
Good Read LED



1.3.2 GOOD READ LED DURATION

By default, the Good Read LED stays on for 40 milliseconds. Specify a value, ranging from 1 to 254 in units of 10 milliseconds.

Good Read LED
Time-out after
0.01~2.54 sec.
(*40 ms)



- 1) Read the barcode above to specify the time interval before the Good Read LED goes off.
- 2) Read the ["Decimal Value"](#) barcode on page 227. For example, read "1" and "5" for the Good Read LED to go off after 150 milliseconds.
- 3) Read the "Validate" barcode on the same page to complete this setting.



1.4 BEEPER

The scanner has a buzzer to provide user feedback in various operating conditions.

Beeping	Meaning
One long beep, high tone	Power on, with red LED on (1 second) and off quickly
two short beeps, high tone	<ul style="list-style-type: none"> ▶ Power off, with red LED on (until the key is released) ▶ Delete the last collected data in memory mode, with red LED on (1 second) and off quickly
One short beep, high tone ▶ Programmable, default to 4 KHz	Good Read, with green LED on-off quickly
Six short beeps ▶ High-low tone repeats three times	<ul style="list-style-type: none"> ▶ Enter Configuration Mode, with red LED flashing ▶ Exit Configuration Mode
Two short beeps, low-high tone	Setup barcode read successfully
One short beep, high tone	<ul style="list-style-type: none"> ▶ More setup barcode required ▶ Input PIN code ▶ Clear PIN code
One short beep, low tone	More barcodes required to complete the "output sequence" requirements of Multi-Barcode Editor, with green LED on-off quickly (Upon completion, same as Good Read.)
One long beep, low tone	<ul style="list-style-type: none"> ▶ Transmit buffer full, with red LED on-off quickly ▶ Transmit buffer disabled, with red LED on-off quickly ▶ Configuration error (Wrong barcode...) ▶ PIN code input error ▶ Reject random PIN request ▶ Fail to send data in memory mode
Two short beeps, high-low tone	<ul style="list-style-type: none"> ▶ Data saved to buffer when transmit buffer is enabled and the scanner is out of range, with red LED on-off quickly ▶ Memory Mode – Memory full, with red LED on-off quickly
Two short beeps, high tone	Low Battery Alarm
Two long beeps, high-low tone	Multi-Barcode Mode – Buffer full
Three short beeps, tone ascending from low to high	<ul style="list-style-type: none"> ▶ WPAN connection established, with blue LED flashing ▶ WPAN connection resumed, with blue LED flashing
Three short beeps, tone ascending from high to low	WPAN connection out of range or suspended



1.4.1 BEEPER VOLUME

Mute	
	101009
Minimum Volume	
	101010
Medium Volume	
	101011
*Maximum Volume	
	101012







1.4.2 GOOD READ BEEP

Frequency

8 kHz	 101001
*4 kHz	 101002
2 kHz	 101003
1 kHz	 101004



Duration

*Shortest	 101005
Shorter	 101006
Longer	 101007
Longest	 101008



1.4.3 LOW BATTERY ALARM (1660)



By default, "2.6 V (Alkaline)" is selected for low battery level. When the battery level inside the 1660 scanner reaches 2.6 V, it will activate the beeper to give a warning. If you are using Ni-MH batteries, select "2.1 V (Ni-MH)". In order to prevent data loss, you are advised to replace the batteries immediately when you hear two short beeps (high tone).

No Alarm	
	101017
*2.6 V (Alkaline)	
	101018
2.1 V (Ni-MH)	
	101019

Note: Ni-MH batteries available in retail stores can be used to replace the two AAA Alkaline batteries.

1.4.4 LOW BATTERY ALARM (1661)

By default, it will activate the beeper to give a warning when the battery charge gets low. In order to prevent data loss, you are advised to replace the battery immediately when you hear two short beeps (high tone).

No Alarm	
	101017
*Low Battery Alarm	
	101018



1.5 SEND "NR" TO HOST

The scanner can send the "NR" string to the host to notify the No Read event.

Enable



100267

*Disable



100266



1.6 SCAN MODES

Different scan modes are supported – select the scan mode that best suits the requirements of a specific application. Refer to the comparison table below.

Scan Mode	Start to Scan				Stop Scanning			
	Always	Press trigger once	Hold trigger	Press trigger twice	Release trigger	Press trigger once	Barcode being read	Timeout
Continuous mode	✓							
Test mode	✓							
Laser mode			✓		✓		✓	✓
Auto Off mode		✓					✓	✓
Auto Power Off mode		✓						✓
Alternate mode		✓				✓		
Aiming mode				✓			✓	✓
Multi-Barcode mode			✓		✓			

Note: By default, the scan mode is set to Laser mode.



1.6.1 CONTINUOUS MODE

The scanner is always scanning.

- ▶ After a successful decoding, the removal of barcode is required. It is not allowed to proceed to decode until the decoding delay time has passed.
- ▶ To decode the same barcode repeatedly, move away the barcode and put it back again and again for scanning.

Note: Refer to "Delay between Re-read".

Continuous Mode



Decoding Delay

Set the time interval between each decoding.

*Disable



0.5 sec



1 sec



2 sec



1.6.2 TEST MODE

The scanner is always scanning.

- ▶ Capable of decoding the same barcode repeatedly without removing it, for testing purpose.

Test Mode



1.6.3 LASER MODE

The scanner will start scanning once the trigger is held down.

- ▶ The scanning won't stop until (1) a barcode is decoded, (2) the pre-set timeout expires, or (3) you release the trigger.

Note: Refer to "Scanning Timeout".

*Laser Mode



1.6.4 AUTO OFF MODE

The scanner will start scanning once the trigger is pressed.

- ▶ The scanning won't stop until (1) a barcode is decoded, and (2) the pre-set timeout expires.

Note: Refer to "Scanning Timeout".

Auto Off Mode



1.6.5 AUTO POWER OFF MODE

The scanner will start scanning once the trigger is pressed.

- ▶ The scanning won't stop until the pre-set timeout expires, and, the pre-set timeout period re-counts after each successful decoding.

Note: Refer to "Delay between Re-read" and "Scanning Timeout".

Auto Power Off Mode



1.6.6 ALTERNATE MODE

The scanner will start scanning once the trigger is pressed

- ▶ The scanning won't stop until you press the trigger again.

Alternate Mode



1.6.7 AIMING MODE

The scanner will aim at a barcode once the trigger is pressed, and start scanning when the trigger is pressed again within one second.

- ▶ The scanning won't stop until (1) a barcode is decoded, and (2) the pre-set timeout expires.

Aiming Mode



Aiming Timeout

You can limit the aiming time interval (1~15). By default, the scanner time-out is set to 1 second.

Aiming Time-out
after 1~15 sec.
(*1)



1. Read the barcode above to specify the time interval before aiming ends. (It is set to 1 by default.)
2. Read the ["Decimal Value"](#) barcode on page 227. For example, read "1" and "0" for the scanner to automatically shut down after being idle for 10 seconds.
3. Read the "Validate" barcode on the same page to complete this setting.



1.6.8 MULTI-BARCODE MODE

The scanner will be scanning as long as the trigger is held down, capable of decoding one single barcode, as well as multiple unique barcodes one at a time. While decoding a bunch of unique barcodes, if a barcode is decoded twice, its subsequent decoding will be ignored and the scanner is expecting another unique barcode.

- ▶ The scanning won't stop until you release the trigger.



Note: (1) A barcode is considered unique when its Code Type or data is different from others.
(2) Multi-Barcode Mode has nothing to do with the [Multi-Barcode Editor](#).



1.7 SCANNING TIMEOUT

Specify the scanning time interval (1~254 sec.; 0= Disable) when the scan mode is set to any of the following –

- ▶ Laser mode
- ▶ Auto Off mode
- ▶ Auto Power Off mode
- ▶ Aiming mode

Scanner Time-out
after 0~254 sec.
(*10)



- 1) Read the barcode above to specify the time interval before the scan engine times out.
- 2) Read the ["Decimal Value"](#) barcode on page 227. For example, read "1" and "5" for the scanner to automatically shut down after being idle for 15 seconds.
- 3) Read the "Validate" barcode on the same page to complete this setting.



1.8 DELAY BETWEEN RE-READ

This is also referred to as the “Blocking Time”, which is used to prevent the scanner from accidentally reading the same barcode twice when the scan mode is set to any of the following –

- ▶ Continuous mode
- ▶ Auto Power Off mode
- ▶ Alternate mode



1.9 READ REDUNDANCY FOR ALL SYMBLOGIES

Select the level of reading security. For example,

- ▶ If "No Redundancy" is selected, one successful decoding will make the reading valid and induce the "READER Event".
- ▶ If "Three Times" is selected, it will take a total of four consecutive successful decoding of the same barcode to make the reading valid. The higher the reading security is (that is, the more redundancy the user selects), the slower the reading speed gets.

It is obvious that the more redundancy you select, the higher the reading security is, and thus, the slower the reading speed becomes. You will have to compromise between reading security and decoding speed.



1.10 ADDON SECURITY FOR UPC/EAN BARCODES

The scanner is capable of decoding a mix of UPC/EAN barcodes with and without addons. The read redundancy (0~30 times) allows changing the number of times to decode a UPC/EAN barcode before transmission. The more redundancy you select, the higher the reading security is, and thus, the slower the reading speed becomes. You will have to compromise between reading security and decoding speed.

Note: UPC/EAN Addon 2 and Addon 5 must be enabled individually for this setting to take effect.

Addon Security Level
(*0~30)



- 1) Read the barcode above to specify the read redundancy for UPC/EAN barcodes. (It is set to 0 by default.)
- 2) Read the "[Decimal Value](#)" barcode on page 227. For example, read "1" and "2" for the scanner to re-read the barcode for 12 times.
- 3) Read the "Validate" barcode on the same page to complete this setting.



1.11 NEGATIVE BARCODES

Normally, barcodes are printed with the color of the bars darker than that of the spaces. But for negative barcodes, they are printed in the opposite sense just like negative films. The spaces of negative barcodes are printed with a color darker than that of the bars. You can configure the scanner to be able to read negative barcodes.

Enable



100225

*Disable



100224



1.12 EFFECTIVE DECODING AREA

By default, the effective decoding area is 100% covered by the scanned area. However, you may narrow down the decoding area to prevent reading the wrong barcode when a number of barcodes are printed closely. The scanner will only read barcodes that appear in the effective decoding area.

Read the barcode "Centering On" and specify the percentage to narrow down the decoding area. For example, read "Left 10%" and then "Right 30%" for the scanner to decode barcode "A" only.

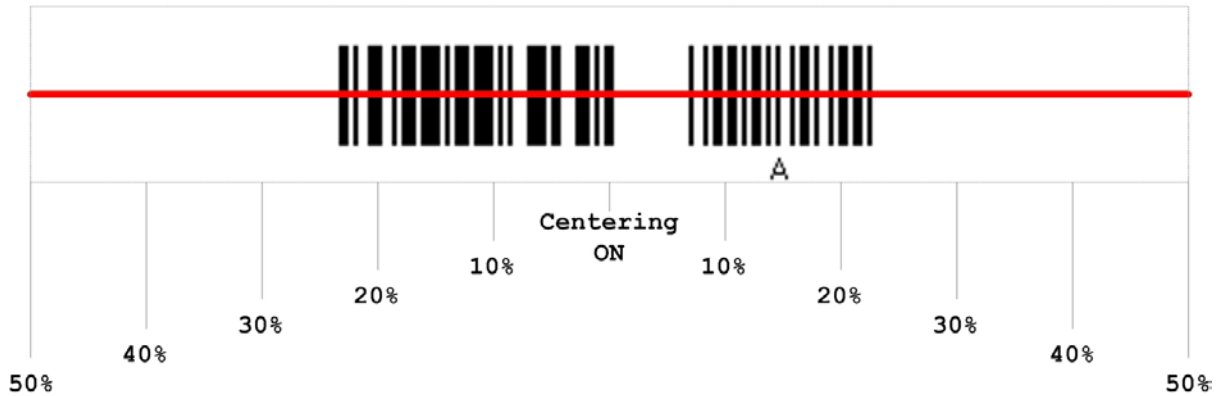

1.12.1 POSITIONING WINDOW

Centering On



*Centering Off



1.12.2 ADJUSTING WINDOW

Percentage for Left Half

*Left 50%	
	100280
Left 40%	
	100281
Left 30%	
	100282
Left 20%	
	100283
Left 10%	
	100284

Percentage for Right Half

Right 10%	
	100288
Right 20%	
	100289
Right 30%	
	100290
Right 40%	
	100291
*Right 50%	
	100292



1.13 1661 USING DIRECT USB CABLE

1661 supports Direct USB interface for charging the battery and/or sending data to the host in memory mode. Refer to [1.2.3 Memory Mode](#).

Note: The scanner is not allowed to function when it is solely on USB power and without a battery loaded.

1.13.1 DIRECT USB INTERFACE

When it is set to Memory Mode and connected to computer via the Direct USB cable, the default output interface becomes "Direct USB Virtual COM". You may change it to "Direct USB HID".

For details on configuring the interface settings, refer to the following sections:

- ▶ [2.6 Direct USB HID \(1661 Memory Mode Only\)](#)
- ▶ [2.7 Direct USB Virtual COM \(1661 Memory Mode Only\)](#)

*Activate Direct
USB Virtual COM



Activate Direct
USB HID



1.13.2 DISABLE DIRECT USB INTERFACE

When connecting the Direct USB cable, you may have the scanner read the "Disable Direct USB" barcode in advance to avoid sending data to the host in memory mode via the cable. It will then allow charging the battery only.

Disable Direct USB



1.14 HARDWARE RESET

1.14.1 RESTORE SYSTEM DEFAULTS

Instead of having the scanner read “Restore System Defaults” barcode, you may use key combination, as described below, to restore system defaults during operation.

- 1) Hold down the [Power/Delete] key.
- 2) When the scanner responds with two short beeps (high tone), press the [Trigger] key for about 5 seconds. The scanner LED indicator becomes solid red for a while and then goes off.
- 3) When the scanner responds with a long beep (high tone), release the keys. Its LED indicator becomes solid red and goes off quickly.

Note: The scanner will restart itself automatically.

1.14.2 RESET CONNECTION

When the output interface is BT HID or BT SPP Master, the scanner will attempt to maintain an established connection. To stop such re-connection, you may need to have the scanner read “Reset Connection” or “Restore System Defaults” barcode to clear the current connection record. Alternatively, you may use key combination, as described below, to reset connection during operation.

- 1) Hold down the [Trigger] key, and then press the [Power/Delete] key for at least 5 seconds.
- 2) The scanner will respond with two short beeps (high tone). Wait for a while until the scanner responds with a long beep (high tone), release the keys.

Note: (1) After reset connection by hardware, the scanner will not restart itself automatically. It will resume to its previous operation except no connection.
(2) For 1660, firmware version 1.34 or later is required.



1.14.3 DISABLE HARDWARE RESET

By default, the key combination for hardware reset (including system defaults restoration and connection reset) is enabled. Users can decide whether to enable/disable the key combination.

***Enable**



101028

Disable



101029





SELECTING OUTPUT INTERFACE

In order to establish a proper connection between your computer and the scanner, we suggest that you follow these instructions –

- 1) Install batteries and hold down the [Power/Delete] key for about 2 seconds to turn on the scanner.
- 2) Have the scanner read the “Enter Setup” barcode to enter the configuration mode.
- 3) Have the scanner read the associated barcodes to activate the desired interface.
See the following sections for output interfaces supported.
- 4) Have the scanner read the barcodes for related settings.
- 5) Have the scanner read the “Update” barcode to exit the configuration mode.
- 6) Turn on your computer or laptop and establish a WPAN connection with the scanner.
Refer to [Chapter 3 – Setting up a WPAN Connection](#).

Note: (1) By default, the output interface is set to “BT HID”.
(2) For 1661, when it is set to Memory Mode and connected to computer via the Direct USB cable, the default output interface becomes “Direct USB Virtual COM”.

IN THIS CHAPTER

2.1 BT HID	54
2.2 BT SPP Slave	66
2.3 BT SPP Master	69
2.4 USB HID via 3610	73
2.5 USB Virtual COM via 3610	84
2.6 Direct USB HID (1661 Memory Mode Only)	86
2.7 Direct USB Virtual COM (1661 Memory Mode Only)	97



2.1 BT HID

For BT HID, refer to [Chapter 3 – Setting up a WPAN Connection](#) for related connection settings. Run any text editor on your computer, and the scanned data will be transmitted to the computer.

HID Settings	Defaults
Keyboard Type	PCAT (US)
Alphabets Layout	Normal
Digits Layout	Normal
Capital Lock Type	Normal
Capital Lock State	Off
Alphabets Transmission	Case-sensitive
Digits Transmission	Alphanumeric keypad
Inter-Character Delay	0 (ms)
Inter-Function Delay	0 (ms)



2.1.1 ACTIVATE BT HID & SELECT KEYBOARD TYPE

When BT HID interface is activated, you will have to select a keyboard type to complete this setting. By default, BT HID is activated on the scanner, and the keyboard type is set to PCAT (US).

Activate BT HID &
Select Keyboard
Type...



- 1) Read the barcode above to activate BT HID and select a keyboard type.

Note: If the scanner responds with one long beep (low tone) upon reading the barcode, it means the current firmware of your scanner is earlier than version 1.21. Please upgrade the firmware to version 1.21 or later!

- 2) Read the “[Decimal Value](#)” barcode on page 227. Refer to the table below for the number of desired keyboard type.
- 3) Read the “Validate” barcode on the same page to complete this setting.

BT HID

By default, the keyboard type is set to PCAT (US). The following keyboard types are supported —

No.	Keyboard Type	No.	Keyboard Type
64	PCAT (US)	72	PCAT (Spanish)
65	PCAT (French)	73	PCAT (Portuguese)
66	PCAT (German)	74	PS55 A01-2 (Japanese)
67	PCAT (Italy)	75	User-defined table
68	PCAT (Swedish)	76	PCAT (Turkish)
69	PCAT (Norwegian)	77	PCAT (Hungarian)
70	PCAT (UK)	78	PCAT (Swiss German)
71	PCAT (Belgium)	79	PCAT (Danish)



2.1.2 RESET CONNECTION

For BT HID, you can only have the scanner connected to one computer at a time. If you want to connect the scanner to another host, you must have it read the “Reset Connection” barcode so that the current connection record will be cleared. Then, the scanner will restart itself automatically. Go through the whole process in [3.2.3 Connect to Dongle](#) to establish a new connection.

Refer to [1.14 Hardware Reset](#).

Reset Connection



Note: The “Restore System Defaults” barcode will have the current connection record cleared as well.



2.1.3 KEYBOARD SETTINGS

- ▶ Alphabets Layout
- ▶ Digits Layout
- ▶ Capital Lock Type
- ▶ Capital Lock Setting
- ▶ Alphabets Transmission
- ▶ Digits Transmission

Note: BT HID does not support these functions on PDAs – (1) Capital Lock Setting: Auto Detection (2) Digits Transmission: Numeric Key

Alphabets Layout

By default, the alphabets layout is set to normal mode, also known as the standard English layout. Select French or German keyboard layout if necessary. The scanner will make adjustments when sending the "A", "Q", "W", "Z", "Y", and "M" characters according to this setting.



Note: This setting only works when the keyboard type selected is US keyboard, such as PCAT (US). The Alphabets Layout and Digits Layout setting must match your keyboard.



US Keyboard Style – Normal

QWERTY layout, which is normally used in western countries.

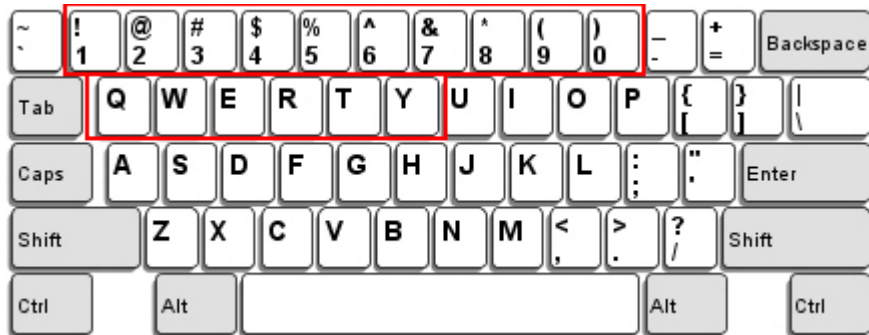

- ▶ Select “Lower Row” for the “Digits Layout” setting for the upper row is for special characters.

French Keyboard Style – AZERTY

French layout; see below for French Keyboard Style.

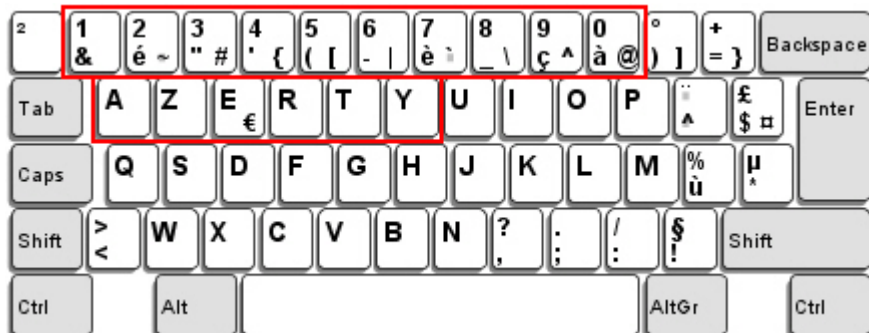

- ▶ Select “Upper Row” for the “Digits Layout” setting for the lower row is for special characters.

German Keyboard Layout – QWERTZ

German layout; see below for German Keyboard Style.

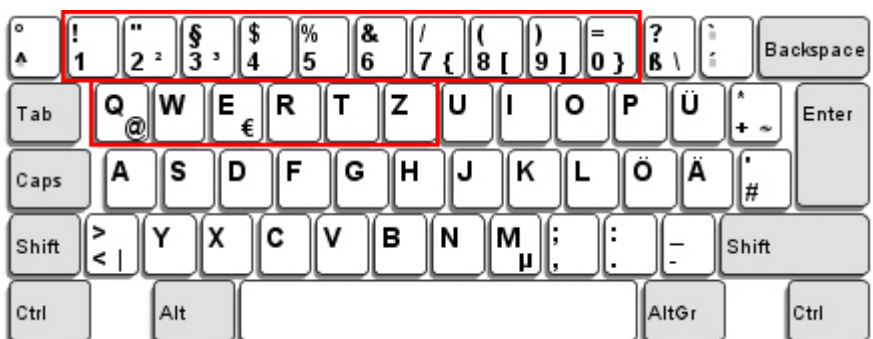

- ▶ Select “Lower Row” for the “Digits Layout” setting for the upper row is for special characters.



Digits Layout

Select a proper layout that matches the alphabets layout. The scanner will make adjustments according to this setting.

Options	Description
Normal	Depends on the [Shift] key or [Shift Lock] setting
Lower Row	For QWERTY or QWERTZ keyboard
Upper Row	For AZERTY keyboard

*Normal



100046

Upper Row



100049

Lower Row



100048

Note: This setting is to be used with the Character Substitution setting when support to certain keyboard types (languages) is unavailable but required.



Capital Lock Type & Setting

In order to send the alphabets with correct case, the scanner needs to know the status of Caps Lock on the keyboard. Incorrect settings may result in reversed case of the alphabets being transmitted.

Cap Lock Type	Description
Normal	Normal type
Capital Lock	When enabled, the keys of alphabetic characters will be interpreted as capital letters. However, this does not affect the number or punctuation keys.
Shift Lock	When enabled, the keys of alphabetic characters will be interpreted as capital letters. In addition, this affects the number or punctuation keys.



Capital Lock State	Description
Capital Lock OFF	Assuming that the status of Caps Lock on the keyboard is OFF, transmitted characters are exactly the same as in the barcode (when "case-sensitive" is selected for Alphabets Transmission).
Capital Lock ON	Assuming that the status of Caps Lock on the keyboard is ON, transmitted characters are exactly the same as in the barcode (when "case-sensitive" is selected for Alphabets Transmission). ▶ Refer to the Capital Lock Type above.
Auto Detection	The scanner will automatically detect the status of Caps Lock on the keyboard before data is transmitted; transmitted characters are exactly the same as in the barcode (when "case-sensitive" is selected for Alphabets Transmission). ▶ This setting is not supported on PDAs.

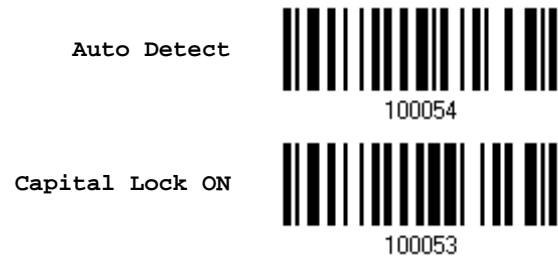

*Capital Lock OFF



100052



Alphabets Transmission

By default, the alphabets transmission is case-sensitive, meaning that the alphabets will be transmitted according to their original case, the status of Caps Lock on the keyboard, as well as the Capital Lock setting. Select [Ignore Case] to have alphabets transmitted according to the status of Caps Lock on the keyboard only.

Ignore Case



100051

*Case-sensitive



100050



Abcd

1. Letter Case for Output Format

Refer to 5.1 Letter Case.

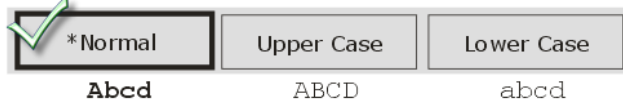

2. Alphabets Transmission for Keyboard Wedge & Bluetooth HID



3a. Check Caps Lock on the keyboard

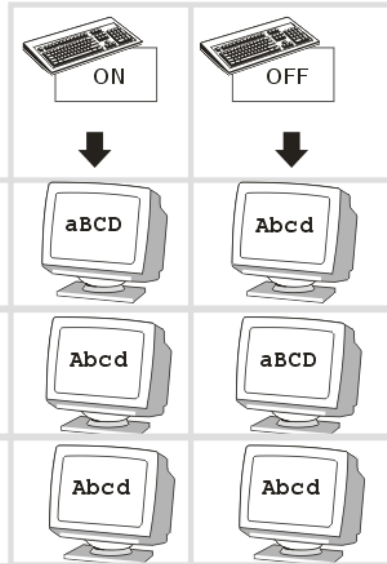

3b. Check Caps Lock on the keyboard

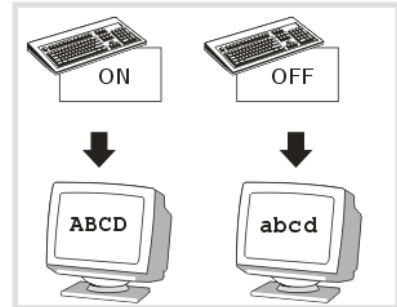

4. Check Capital Lock setting

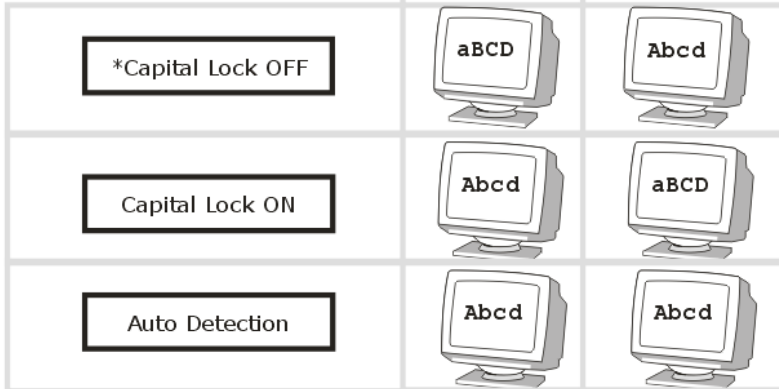

Digits Transmission

By default, the alphanumeric keypad is used for transmitting digits. Select "Numeric Keypad" if you wish to use the keys on the numeric keypad.

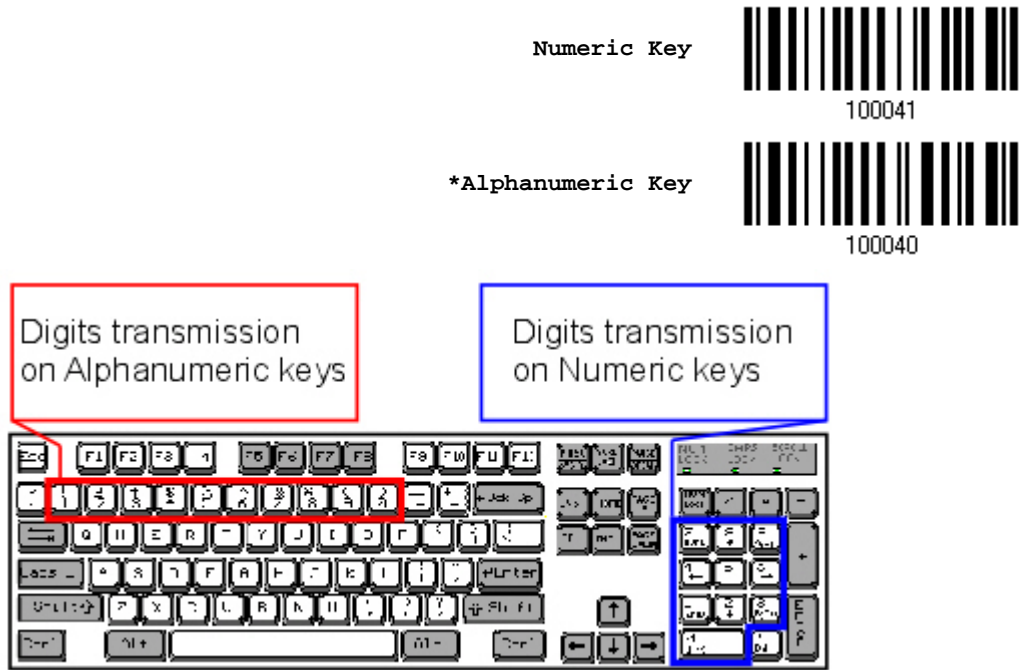

Note: If you select "Numeric Keypad", the Num Lock status of the physical keyboard should be "ON". This setting is not supported on PDAs.



2.1.4 INTER-CHARACTER DELAY

By default, the inter-character delay is set to zero. Specify a value, ranging from 0 to 254 in units of millisecond, to match the computer response time of the keyboard interface. Such delay time is inserted between every character being transmitted. The longer the delay time is, the slower the transmission speed will be.

Inter-Character
Delay... (*0~254)



- 1) Read the barcode above to specify the inter-character delay.
- 2) Read the "[Decimal Value](#)" barcode on page 227 for the desired inter-character delay (millisecond).
- 3) Read the "Validate" barcode on the same page to complete this setting.

2.1.5 INTER-FUNCTION DELAY

By default, the inter-function delay is set to zero. Specify a value, ranging from 0 to 254 in units of millisecond, to match the computer response time of the keyboard interface. Such delay time is inserted between every function code (0x01 ~ 0x1F) being transmitted. The longer the delay time is, the slower the transmission speed will be.

Inter-Function
Delay... (*0~254)



- 1) Read the barcode to specify the inter-function delay.
- 2) Read the "[Decimal Value](#)" barcode on page 227 for the desired inter-function delay (millisecond).
- 3) Read the "Validate" barcode on the same page to complete this setting.



2.1.6 HID CHARACTER TRANSMIT MODE

By default, HID interface sends data to the host in batch. You may have the scanner read the "By Character" barcode to process data one character at a time.

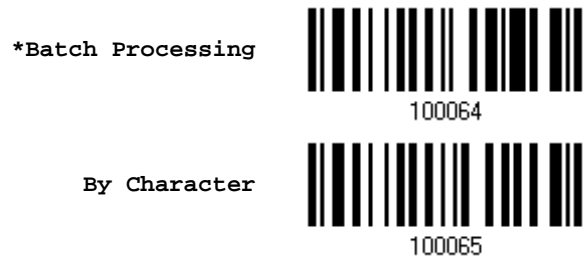

Note: "By Character" transmit mode is required when working with iPhone or iPad.

2.1.7 KEYPAD SUPPORT FOR IPHONE/IPAD

When the scanner has been successfully connected to iPhone or iPad for data collection, the onscreen keypad of iPhone or iPad will disappear. You may have the scanner read the "Use POWER Key to Show or Hide Keypad" barcode in advance. Then, it will allow pressing the [Power/Delete] key to show or hide the onscreen keypad.

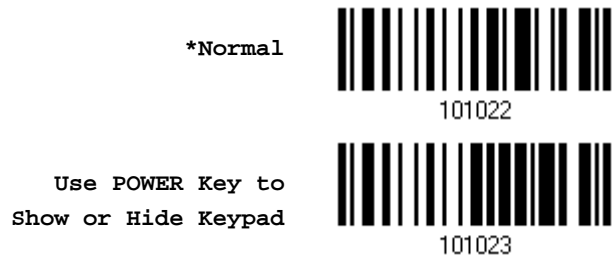

Instead of using the [Power/Delete] key, you may have the scanner read the following barcode to show or hide the keypad.



Note: This function only works for (1) iPhone 4 and 3GS version 4.1 or later, and (2) iPad version 4.2 or later.



2.1.8 TRANSMIT SPEED

By default, the BT HID transmit speed is set to normal. Users can have the scanner work in quicker transmit speed by reading the Fast barcode.



2.1.9 BT HID SLAVE/MASTER SWITCHING

By default, the BT HID role is set to slave. Users can have the scanner switch between slave and master by reading the barcodes below.



2.1.10 BT HID AUTO-RECONNECTION (1661 ONLY)

Users can decide whether to have the scanner automatically reconnect to a paired device after disconnection, and the occasion for reconnecting.

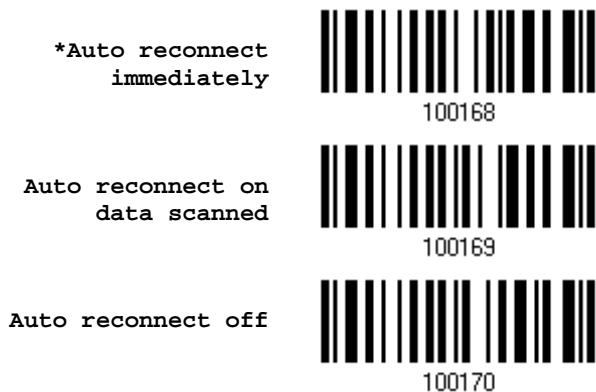

2.2 BT SPP SLAVE

For BT SPP Slave, refer to [Chapter 3 – Setting up a WPAN Connection](#) for related connection settings.

2.2.1 ACTIVATE BT SPP SLAVE MODE

This is SPP Slave Mode.

Activate BT SPP,
Slave Mode



2.2.2 INTER-FUNCTION DELAY

By default, the inter-function delay is set to zero. Specify a value, ranging from 0 to 254 in units of millisecond, to match the computer response time of the keyboard interface. Such delay time is inserted between every function code (0x01 ~ 0x1F) being transmitted. The longer the delay time is, the slower the transmission speed will be.

Inter-Function
Delay... (*0~254)



- 1) Read the barcode above to specify the inter-function delay.
- 2) Read the "[Decimal Value](#)" barcode on page 227 for the desired inter-function delay (millisecond).
- 3) Read the "Validate" barcode on the same page to complete this setting.



2.2.3 ACK/NAK TIMEOUT

By default, the scanner sends data to the host without waiting for an ACK/NAK response before sending more data. Specify a value, ranging from 1 to 99 in units of 0.1 second. If no response within the specified period of time, the scanner will attempt to send the same data two more times. If all three attempts fail without any notification, data loss will occur.

ACK/NAK Time-out
after ... (*0~99)



100013

- 1) Read the barcode to specify the time interval for the scanner to send data and wait for a response from the host.
- 2) Read the ["Decimal Value"](#) barcode on page 227. For example, read "1" and "0" for the scanner to automatically shut down after being idle for 1 second.
- 3) Read the "Validate" barcode on the same page to complete this setting.

ACK/NAK Error Beep

Enable Error Beep



100015

*Disable Error Beep



100014

Note: We suggest enabling the error beep so that you will be notified of such data loss and have the scanner re-read data.



2.3 BT SPP MASTER

As a SPP master device, the scanner will be able to resume connection with the host upon powering on again, as long as the host application is running. If the scanner fails to resume connection, it will try every 5 seconds to re-connect to the host unless you have the scanner read the “Reset Connection” or “Restore System Defaults” barcode.

For BT SPP Master, refer to [3.2.2 Configure Related Settings](#) for related connection settings.

Note: In SPP Master Mode, if it fails to re-connect within the specified period of time (2 minutes by default), the scanner will become inactive to save power. Once the re-connection is established successfully, the scanner will not go through transition from full CPU speed to low CPU speed even though it is idle during the specified time interval for Auto Power Off. It will automatically turn off when the time is up. Refer to [1.1.2 Auto Power Off & Power-Saving](#).

2.3.1 ACTIVATE BT SPP MASTER MODE

This is SPP Master Mode.

Activate BT SPP,
Master Mode



How to connect with the target device?

Produce two setup barcodes for the target SPP slave device, just like what we do for 3610.

- ▶ “Set Connection”
- ▶ “MAC ID”

Note: The “MAC ID” barcode must have a prefix of two characters, either “0x” or “OX”, followed by the real MAC address of the target device.

Usage:

1. Read the “Activate BT SPP, Master Mode” barcode above and barcodes for connection settings, such as authentication and preset PIN. Skip this step if no connection settings are desired.
2. Read the “Set Connection” and “MAC ID” barcodes. The scanner will respond with one beep upon reading each of the barcodes.

Set Connection



Note: Read the “Set Connection” barcode first, and then the “MAC ID” barcode within 10 seconds.

Instead of producing the “MAC ID” barcode, you may have the scanner read the setup barcodes for entering the MAC address.

- ▶ Have the scanner read the “Abort” barcode to cancel the operation at any time while reading setup barcodes for the MAC address. If the MAC address has not been completed yet, having the scanner read the “Validate” barcode can cancel the operation as well.

Enter MAC ID in
Hexadecimal...



Usage:

1. Read the barcode above.
2. Read the [“Hexadecimal Value”](#) barcode on page 228 for the desired MAC address.
3. Read the “Validate” barcode on the same page to complete this setting.

Exit SPP Master Mode

To stop such re-connection, have the scanner read “Reset Connection” or “Restore System Defaults” barcode so that the current connection record (= MAC ID) will be cleared. Then, the scanner will restart itself automatically. Go through the whole process in [3.2.3 Connect to Dongle](#) to establish a new WPAN connection.

Refer to [1.14 Hardware Reset](#).

Reset Connection



2.3.2 INTER-FUNCTION DELAY

By default, the inter-function delay is set to zero. Specify a value, ranging from 0 to 254 in units of millisecond, to match the computer response time of the keyboard interface. Such delay time is inserted between every function code (0x01 ~ 0x1F) being transmitted. The longer the delay time is, the slower the transmission speed will be.

Inter-Function
Delay... (*0~254)



- 1) Read the barcode above to specify the inter-function delay.
- 2) Read the "[Decimal Value](#)" barcode on page 227 for the desired inter-function delay (millisecond).
- 3) Read the "Validate" barcode on the same page to complete this setting.



2.3.3 ACK/NAK TIMEOUT

By default, the scanner sends data to the host without waiting for an ACK/NAK response before sending more data. Specify a value, ranging from 1 to 99 in units of 0.1 second. If no response within the specified period of time, the scanner will attempt to send the same data two more times. If all three attempts fail without any notification, data loss will occur.

ACK/NAK Time-out
after ... (*0~99)



100013

- 1) Read the barcode above to specify the time interval for the scanner to send data and wait for a response from the host.
- 2) Read the ["Decimal Value"](#) barcode on page 227. For example, read "1" and "0" for the scanner to automatically shut down after being idle for 1 second.
- 3) Read the "Validate" barcode on the same page to complete this setting.

ACK/NAK Error Beep

Enable Error Beep



100015

*Disable Error Beep



100014

Note: We suggest enabling the error beep so that you will be notified of such data loss and have the scanner re-read data.

2.3.4 SWITCH BETWEEN MASTER/SLAVE MODE

After the scanner has established a connection as a SPP slave device, you may have it read the "Activate BT SPP, Master Mode" setup barcode to switch to SPP Master Mode. This will result in easy and reliable re-connection, just like connecting with 3610.



2.4 USB HID VIA 3610

For USB HID, connect 3610 to the USB port of PC, and then connect the scanner to 3610. Run any text editor on your computer, and the scanned data will be transmitted to the computer.

HID Settings	Defaults
Keyboard Type	PCAT (US)
Digits Layout	Normal
Capital Lock Type	Normal
Capital Lock State	Off
Alphabets Transmission	Case-sensitive
Digits Transmission	Alphanumeric keypad
Inter-Character Delay	0 (ms)
Inter-Function Delay	0 (ms)



2.4.1 ACTIVATE USB HID & SELECT KEYBOARD TYPE

When USB HID interface is activated, you will have to select a keyboard type to complete this setting.

Activate
3610 USB HID & Select
Keyboard Type...



- 1) Read the barcode above to activate USB HID and select a keyboard type.
- 2) Read the “[Decimal Value](#)” barcode on page 227. Refer to the table below for the number of desired keyboard type.
- 3) Read the “Validate” barcode on the same page to complete this setting.

USB HID

By default, the keyboard type is set to PCAT (US). The following keyboard types are supported —

No.	Keyboard Type	No.	Keyboard Type
64	PCAT (US)	72	PCAT (Spanish)
65	PCAT (French)	73	PCAT (Portuguese)
66	PCAT (German)	74	PS55 A01-2 (Japanese)
67	PCAT (Italy)	75	User-defined table
68	PCAT (Swedish)	76	PCAT (Turkish)
69	PCAT (Norwegian)	77	PCAT (Hungarian)
70	PCAT (UK)	78	PCAT (Swiss German)
71	PCAT (Belgium)	79	PCAT (Danish)



2.4.2 KEYBOARD SETTINGS

- ▶ Alphabets Layout
- ▶ Digits Layout
- ▶ Capital Lock Type
- ▶ Capital Lock Setting
- ▶ Alphabets Transmission
- ▶ Digits Transmission

Alphabets Layout

By default, the alphabets layout is set to normal mode, also known as the standard English layout. Select French or German keyboard layout if necessary. The scanner will make adjustments when sending the "A", "Q", "W", "Z", "Y", and "M" characters according to this setting.



Note: This setting only works when the keyboard type selected is US keyboard, such as PCAT (US). The Alphabets Layout and Digits Layout setting must match your keyboard.



US Keyboard Style – Normal

QWERTY layout, which is normally used in western countries.

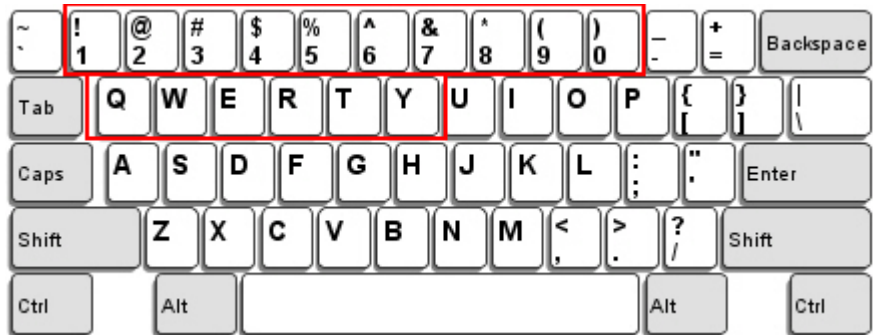

- ▶ Select “Lower Row” for the “Digits Layout” setting for the upper row is for special characters.

French Keyboard Style – AZERTY

French layout; see below for French Keyboard Style.

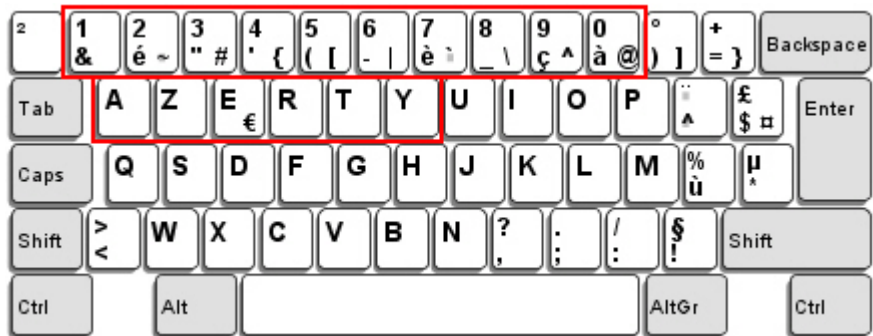

- ▶ Select “Upper Row” for the “Digits Layout” setting for the lower row is for special characters.

German Keyboard Layout – QWERTZ

German layout; see below for German Keyboard Style.

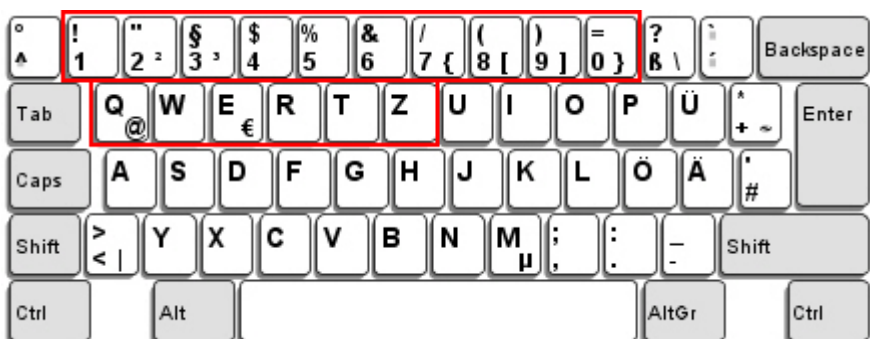

- ▶ Select “Lower Row” for the “Digits Layout” setting for the upper row is for special characters.



Digits Layout

Select a proper layout that matches the alphabets layout. The scanner will make adjustments according to this setting.

Options	Description
Normal	Depends on the [Shift] key or [Shift Lock] setting
Lower Row	For QWERTY or QWERTZ keyboard
Upper Row	For AZERTY keyboard

*Normal



100046

Upper Row



100049

Lower Row



100048

Note: This setting is to be used with the Character Substitution setting when support to certain keyboard types (languages) is unavailable but required.



Capital Lock Type & Setting

In order to send the alphabets with correct case, the scanner needs to know the status of Caps Lock on the keyboard. Incorrect settings may result in reversed case of the alphabets being transmitted.

Cap Lock Type	Description
Normal	Normal type
Capital Lock	When enabled, the keys of alphabetic characters will be interpreted as capital letters. However, this does not affect the number or punctuation keys.
Shift Lock	When enabled, the keys of alphabetic characters will be interpreted as capital letters. In addition, this affects the number or punctuation keys.



Capital Lock State	Description
Capital Lock OFF	Assuming that the status of Caps Lock on the keyboard is OFF, transmitted characters are exactly the same as in the barcode (when "case-sensitive" is selected for Alphabets Transmission).
Capital Lock ON	Assuming that the status of Caps Lock on the keyboard is ON, transmitted characters are exactly the same as in the barcode (when "case-sensitive" is selected for Alphabets Transmission). ▶ Refer to the Capital Lock Type above.
Auto Detection	The scanner will automatically detect the status of Caps Lock on the keyboard before data is transmitted; transmitted characters are exactly the same as in the barcode (when "case-sensitive" is selected for Alphabets Transmission).



*Capital Lock OFF



100052



Alphabets Transmission

By default, the alphabets transmission is case-sensitive, meaning that the alphabets will be transmitted according to their original case, the status of Caps Lock on the keyboard, as well as the Capital Lock setting. Select [Ignore Case] to have alphabets transmitted according to the status of Caps Lock on the keyboard only.

Ignore Case



100051

*Case-sensitive



100050



Abcd

1. Letter Case for Output Format

Refer to 5.1 Letter Case.

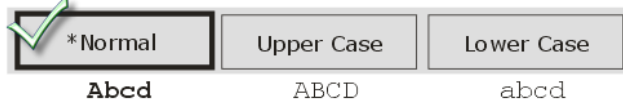

2. Alphabets Transmission for Keyboard Wedge & Bluetooth HID



3a. Check Caps Lock on the keyboard

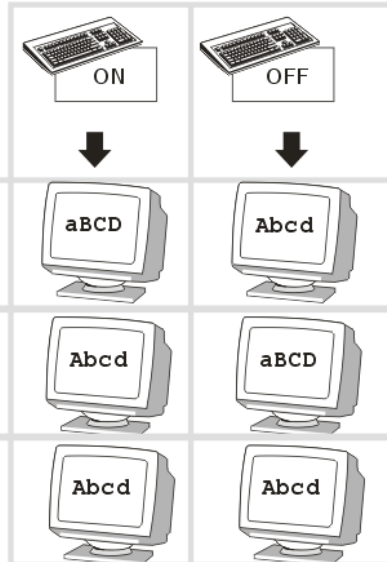

3b. Check Caps Lock on the keyboard

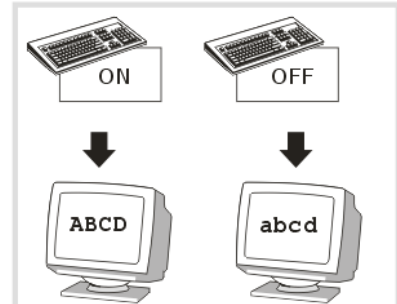

4. Check Capital Lock setting

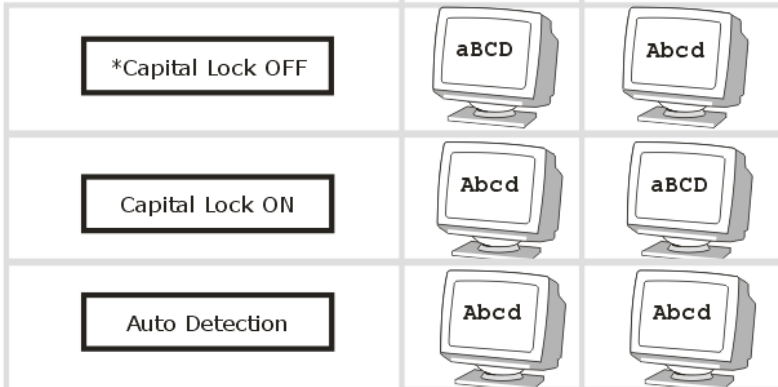

Digits Transmission

By default, the alphanumeric keypad is used for transmitting digits. Select "Numeric Keypad" if you wish to use the keys on the numeric keypad.

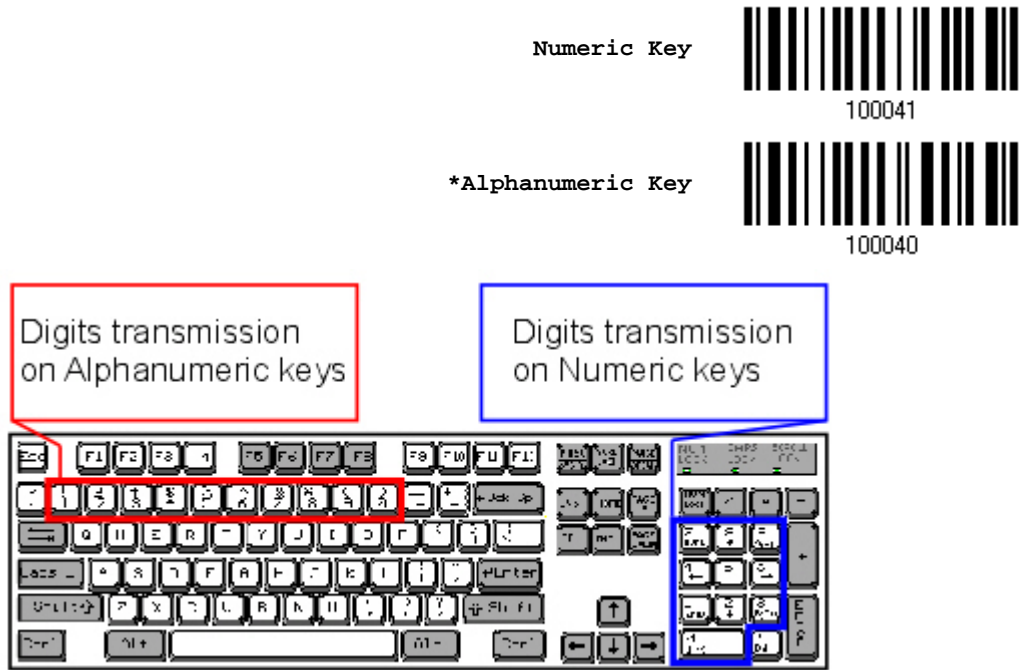

Note: If you select "Numeric Keypad", the Num Lock status of the physical keyboard should be "ON".



2.4.3 INTER-CHARACTER DELAY

By default, the inter-character delay is set to zero. Specify a value, ranging from 0 to 254 in units of millisecond, to match the computer response time of the keyboard interface. Such delay time is inserted between every character being transmitted. The longer the delay time is, the slower the transmission speed will be.

Inter-Character
Delay... (*0~254)



- 1) Read the barcode above to specify the inter-character delay.
- 2) Read the "[Decimal Value](#)" barcode on page 227 for the desired inter-character delay (millisecond).
- 3) Read the "Validate" barcode on the same page to complete this setting.

2.4.4 INTER-FUNCTION DELAY

By default, the inter-function delay is set to zero. Specify a value, ranging from 0 to 254 in units of millisecond, to match the computer response time of the keyboard interface. Such delay time is inserted between every function code (0x01 ~ 0x1F) being transmitted. The longer the delay time is, the slower the transmission speed will be.

Inter-Function
Delay... (*0~254)



- 1) Read the barcode above to specify the inter-function delay.
- 2) Read the "[Decimal Value](#)" barcode on page 227 for the desired inter-function delay (millisecond).
- 3) Read the "Validate" barcode on the same page to complete this setting.



2.4.5 HID CHARACTER TRANSMIT MODE

By default, HID interface sends data to the host in batch. You may have the scanner read the "By Character" barcode to process data one character at a time.

*Batch Processing



By Character



2.5 USB VIRTUAL COM VIA 3610

Connect 3610 to the USB port of PC, and then connect the scanner to 3610. You may run HyperTerminal.exe on your computer, and the scanned data will be transmitted to the computer.

2.5.1 ACTIVATE USB VIRTUAL COM

Activate 3610 USB
Virtual COM



Note: If you are using USB Virtual COM for the first time, you must install its driver. Driver version 5.4 or later is required. Please remove older versions!

2.5.2 ACTIVATE USB VIRTUAL COM_CDC

Activate 3610 USB
Virtual COM_CDC



Note: 3610 with firmware version 2.0 or later supports this function.

2.5.3 INTER-FUNCTION DELAY

By default, the inter-function delay is set to zero. Specify a value, ranging from 0 to 254 in units of millisecond, to match the computer response time of the keyboard interface. Such delay time is inserted between every function code (0x01 ~ 0x1F) being transmitted. The longer the delay time is, the slower the transmission speed will be.

Inter-Function
Delay... (*0~254)



- 1) Read the barcode above to specify the inter-function delay.
- 2) Read the "[Decimal Value](#)" barcode on page 227 for the desired inter-function delay (millisecond).
- 3) Read the "Validate" barcode on the same page to complete this setting.



2.5.4 ACK/NAK TIMEOUT

By default, the scanner sends data to the host without waiting for an ACK/NAK response before sending more data. Specify a value, ranging from 1 to 99 in units of 0.1 second. If no response within the specified period of time, the scanner will attempt to send the same data two more times. If all three attempts fail without any notification, data loss will occur.

ACK/NAK Time-out
after ... (*0~99)



100013

- 1) Read the barcode above to specify the time interval for the scanner to send data and wait for a response from the host.
- 2) Read the ["Decimal Value"](#) barcode on page 227. For example, read "1" and "0" for the scanner to automatically shut down after being idle for 1 second.
- 3) Read the "Validate" barcode on the same page to complete this setting.

ACK/NAK Error Beep

Enable Error Beep



100015

*Disable Error Beep



100014

Note: We suggest enabling the error beep so that you will be notified of such data loss and have the scanner re-read data.



2.6 DIRECT USB HID (1661 MEMORY MODE ONLY)

Only 1661 supports “Direct” USB HID interface for memory mode. Use the provided USB cable to connect 1661 to the USB port of PC. Run any text editor on your computer, and the scanned data will be transmitted to the computer. Refer to [1.2.3 Memory Mode](#).

HID Settings	Defaults
Keyboard Type	PCAT (US)
Digits Layout	Normal
Capital Lock Type	Normal
Capital Lock State	Off
Alphabets Transmission	Case-sensitive
Digits Transmission	Alphanumeric keypad
Inter-Character Delay	0 (ms)
Inter-Function Delay	0 (ms)



2.6.1 ACTIVATE USB HID & SELECT KEYBOARD TYPE

When USB HID interface is activated, you will have to select a keyboard type to complete this setting.

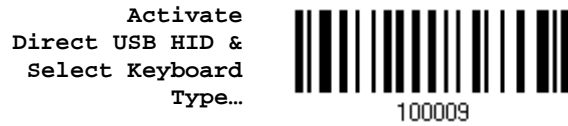

- 1) Read the barcode above to activate USB HID and select a keyboard type.
- 2) Read the “[Decimal Value](#)” barcode on page 227. Refer to the table below for the number of desired keyboard type.
- 3) Read the “Validate” barcode on the same page to complete this setting.

USB HID

By default, the keyboard type is set to PCAT (US). The following keyboard types are supported —

No.	Keyboard Type	No.	Keyboard Type
64	PCAT (US)	72	PCAT (Spanish)
65	PCAT (French)	73	PCAT (Portuguese)
66	PCAT (German)	74	PS55 A01-2 (Japanese)
67	PCAT (Italy)	75	User-defined table
68	PCAT (Swedish)	76	PCAT (Turkish)
69	PCAT (Norwegian)	77	PCAT (Hungarian)
70	PCAT (UK)	78	PCAT (Swiss German)
71	PCAT (Belgium)	79	PCAT (Danish)



2.6.2 KEYBOARD SETTINGS

- ▶ Alphabets Layout
- ▶ Digits Layout
- ▶ Capital Lock Type
- ▶ Capital Lock Setting
- ▶ Alphabets Transmission
- ▶ Digits Transmission

Alphabets Layout

By default, the alphabets layout is set to normal mode, also known as the standard English layout. Select French or German keyboard layout if necessary. The scanner will make adjustments when sending the "A", "Q", "W", "Z", "Y", and "M" characters according to this setting.



Note: This setting only works when the keyboard type selected is US keyboard, such as PCAT (US). The Alphabets Layout and Digits Layout setting must match your keyboard.



US Keyboard Style – Normal

QWERTY layout, which is normally used in western countries.

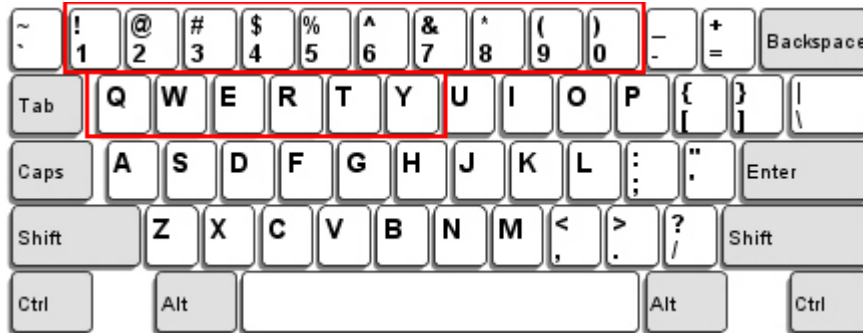

- ▶ Select “Lower Row” for the “Digits Layout” setting for the upper row is for special characters.

French Keyboard Style – AZERTY

French layout; see below for French Keyboard Style.

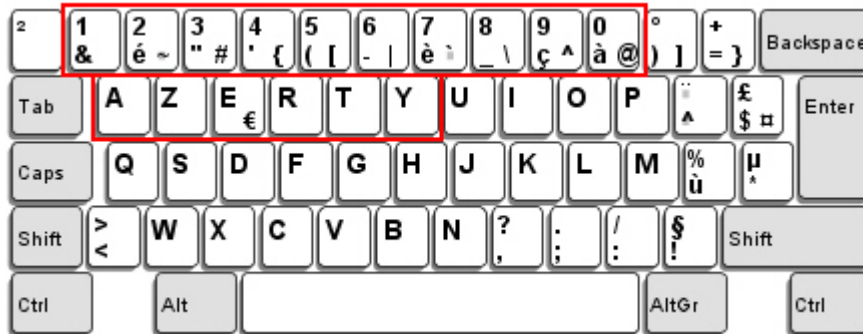

- ▶ Select “Upper Row” for the “Digits Layout” setting for the lower row is for special characters.

German Keyboard Layout – QWERTZ

German layout; see below for German Keyboard Style.

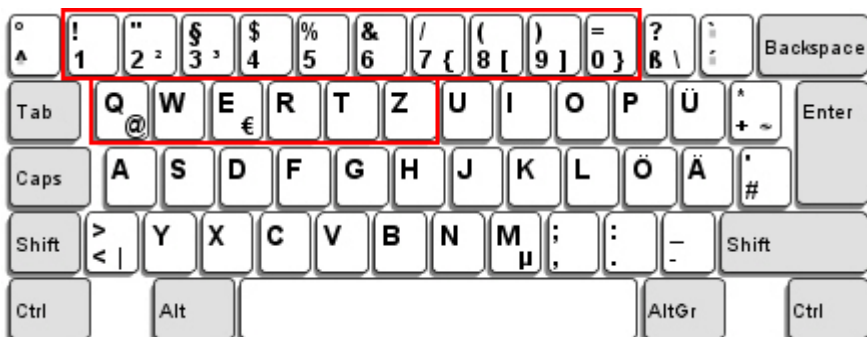

- ▶ Select “Lower Row” for the “Digits Layout” setting for the upper row is for special characters.



Digits Layout

Select a proper layout that matches the alphabets layout. The scanner will make adjustments according to this setting.

Options	Description
Normal	Depends on the [Shift] key or [Shift Lock] setting
Lower Row	For QWERTY or QWERTZ keyboard
Upper Row	For AZERTY keyboard

*Normal



100046

Upper Row



100049

Lower Row



100048

Note: This setting is to be used with the Character Substitution setting when support to certain keyboard types (languages) is unavailable but required.



Capital Lock Type & Setting

In order to send the alphabets with correct case, the scanner needs to know the status of Caps Lock on the keyboard. Incorrect settings may result in reversed case of the alphabets being transmitted.

Cap Lock Type	Description
Normal	Normal type
Capital Lock	When enabled, the keys of alphabetic characters will be interpreted as capital letters. However, this does not affect the number or punctuation keys.
Shift Lock	When enabled, the keys of alphabetic characters will be interpreted as capital letters. In addition, this affects the number or punctuation keys.



Capital Lock State	Description
Capital Lock OFF	Assuming that the status of Caps Lock on the keyboard is OFF, transmitted characters are exactly the same as in the barcode (when "case-sensitive" is selected for Alphabets Transmission).
Capital Lock ON	Assuming that the status of Caps Lock on the keyboard is ON, transmitted characters are exactly the same as in the barcode (when "case-sensitive" is selected for Alphabets Transmission). ▶ Refer to the Capital Lock Type above.
Auto Detection	The scanner will automatically detect the status of Caps Lock on the keyboard before data is transmitted; transmitted characters are exactly the same as in the barcode (when "case-sensitive" is selected for Alphabets Transmission).



*Capital Lock OFF



100052



Enter Setup

Alphabets Transmission

By default, the alphabets transmission is case-sensitive, meaning that the alphabets will be transmitted according to their original case, the status of Caps Lock on the keyboard, as well as the Capital Lock setting. Select [Ignore Case] to have alphabets transmitted according to the status of Caps Lock on the keyboard only.

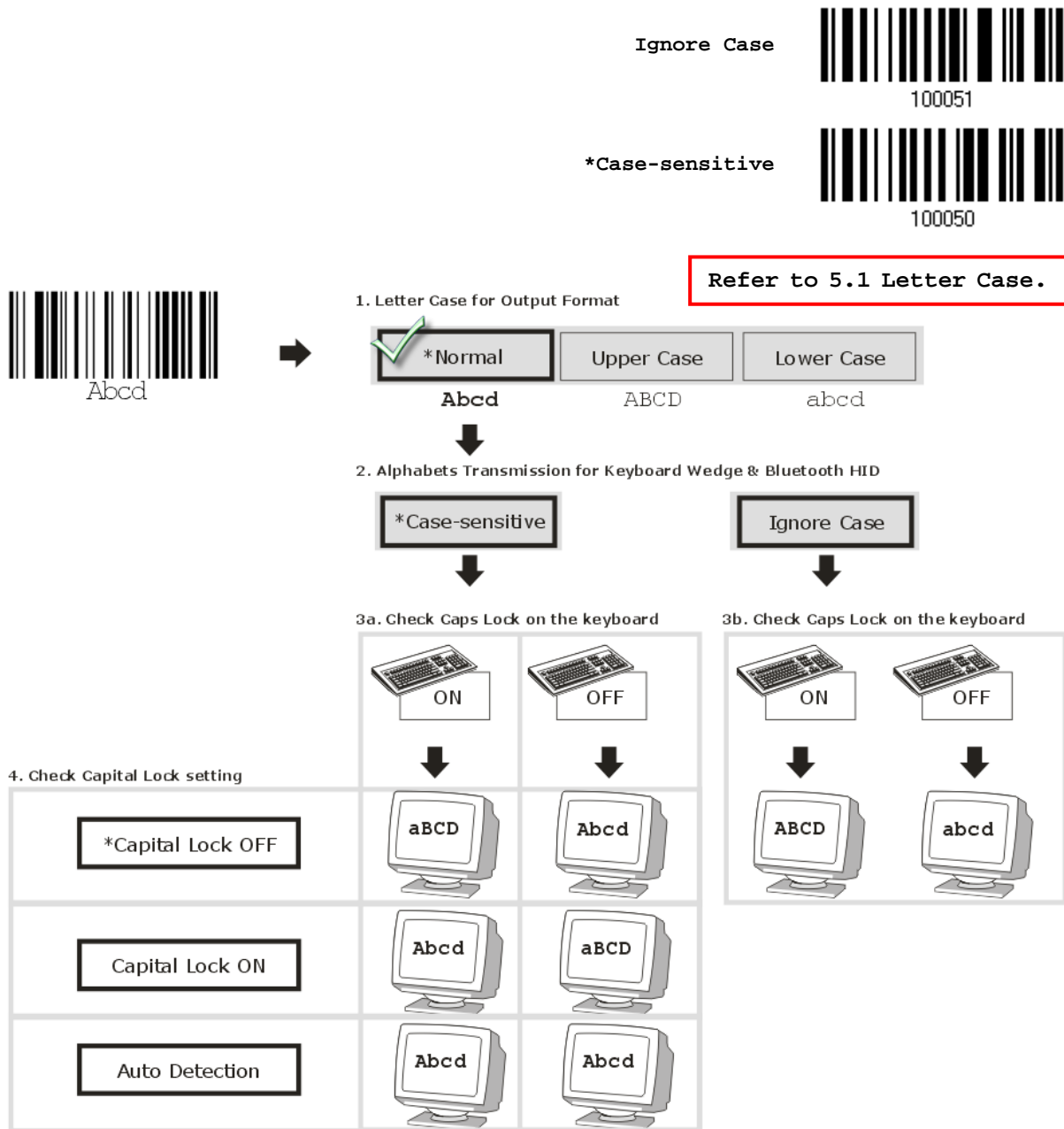

Digits Transmission

By default, the alphanumeric keypad is used for transmitting digits. Select "Numeric Keypad" if you wish to use the keys on the numeric keypad.

Numeric Key



100041

*Alphanumeric Key



100040

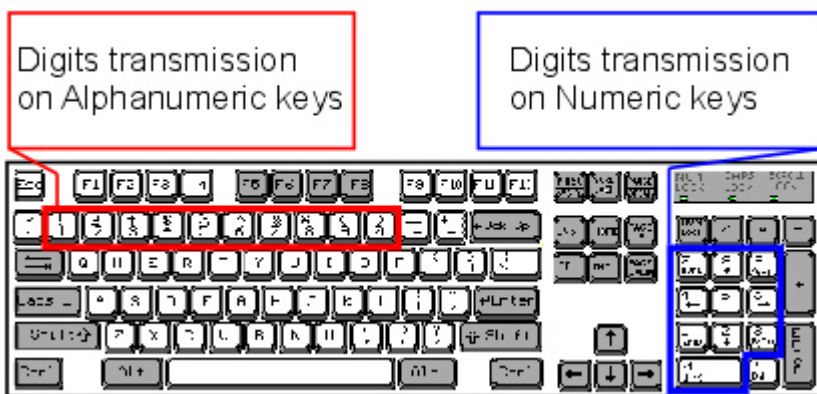

Note: If you select "Numeric Keypad", the Num Lock status of the physical keyboard should be "ON".



2.6.3 INTER-CHARACTER DELAY

By default, the inter-character delay is set to zero. Specify a value, ranging from 0 to 254 in units of millisecond, to match the computer response time of the keyboard interface. Such delay time is inserted between every character being transmitted. The longer the delay time is, the slower the transmission speed will be.

Inter-Character
Delay... (*0~254)



- 1) Read the barcode above to specify the inter-character delay.
- 2) Read the "[Decimal Value](#)" barcode on page 227 for the desired inter-character delay (millisecond).
- 3) Read the "Validate" barcode on the same page to complete this setting.

2.6.4 INTER-FUNCTION DELAY

By default, the inter-function delay is set to zero. Specify a value, ranging from 0 to 254 in units of millisecond, to match the computer response time of the keyboard interface. Such delay time is inserted between every function code (0x01 ~ 0x1F) being transmitted. The longer the delay time is, the slower the transmission speed will be.

Inter-Function
Delay... (*0~254)



- 1) Read the barcode above to specify the inter-function delay.
- 2) Read the "[Decimal Value](#)" barcode on page 227 for the desired inter-function delay (millisecond).
- 3) Read the "Validate" barcode on the same page to complete this setting.



2.6.5 HID CHARACTER TRANSMIT MODE

By default, HID interface sends data to the host in batch. You may have the scanner read the "By Character" barcode to process data one character at a time.

*Batch Processing



By Character



2.7 DIRECT USB VIRTUAL COM (1661 MEMORY MODE ONLY)

Only 1661 supports “Direct” USB Virtual COM interface for memory mode. Use the provided USB cable to connect 1661 to the USB port of PC. You may run HyperTerminal.exe on your computer, and the scanned data will be transmitted to the computer. Refer to [1.2.3 Memory Mode](#).

Note: If you are using USB Virtual COM for the first time, you must install its driver. Driver version 5.4 or later is required. Please remove older versions!

2.7.1 ACTIVATE USB VIRTUAL COM

*Activate Direct USB
Virtual COM



2.7.2 INTER-FUNCTION DELAY

By default, the inter-function delay is set to zero. Specify a value, ranging from 0 to 254 in units of millisecond, to match the computer response time of the keyboard interface. Such delay time is inserted between every function code (0x01 ~ 0x1F) being transmitted. The longer the delay time is, the slower the transmission speed will be.

Inter-Function
Delay... (*0~254)



- 1) Read the barcode above to specify the inter-function delay.
- 2) Read the “[Decimal Value](#)” barcode on page 227 for the desired inter-function delay (millisecond).
- 3) Read the “Validate” barcode on the same page to complete this setting.



2.7.3 ACK/NAK TIMEOUT

By default, the scanner sends data to the host without waiting for an ACK/NAK response before sending more data. Specify a value, ranging from 1 to 99 in units of 0.1 second. If no response within the specified period of time, the scanner will attempt to send the same data two more times. If all three attempts fail without any notification, data loss will occur.

ACK/NAK Time-out
after ... (*0~99)



100013

- 1) Read the barcode above to specify the time interval for the scanner to send data and wait for a response from the host.
- 2) Read the ["Decimal Value"](#) barcode on page 227. For example, read "1" and "0" for the scanner to automatically shut down after being idle for 1 second.
- 3) Read the "Validate" barcode on the same page to complete this setting.

ACK/NAK Error Beep

Enable Error Beep



100015

*Disable Error Beep



100014

Note: We suggest enabling the error beep so that you will be notified of such data loss and have the scanner re-read data.



SETTING UP A WPAN CONNECTION

The scanner can be configured to send data to a host computer wirelessly via the 3610 dongle, or to a notebook computer or PDA with *Bluetooth*[®] wireless technology. Upon powering up, the scanner will be ready for establishing a WPAN connection.

To establish a connection via 3610 after reading “Set Connection” and “Serial No.” labels ...

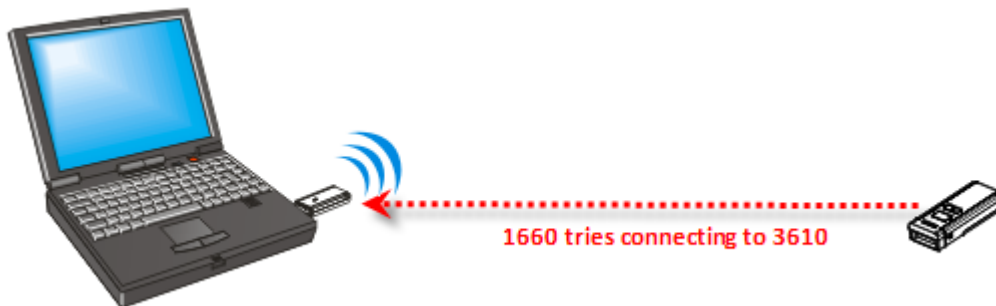

Interface Option	Reference
USB HID	2.4 USB HID via 3610
USB Virtual COM	2.5 USB Virtual COM via 3610

To establish a connection via *Bluetooth*[®] dongle after pairing ...



Interface Option	Reference
BT HID	2.1 BT HID
BT SPP	2.2 BT SPP Slave , 2.3 BT SPP Master

IN THIS CHAPTER

3.1 Connecting via 3610.....	100
3.2 Connecting via <i>Bluetooth</i> [®] Dongle.....	103



3.1 CONNECTING VIA 3610

By default, the interface of 3610 is set to “USB HID”. Connect 3610 to the USB port of PC, and then connect the scanner to 3610. You can have up to seven scanners connected to one computer at the same time.

Note: If you are using USB Virtual COM for the first time, you must install its driver. Driver version 5.4 or later is required. Please remove older versions!

3.1.1 CONNECT TO 3610

You can connect any scanner to 3610 by having the scanner read the two labels at the back of 3610. The scanner will respond with one beep upon reading each of the labels.

- ▶ “Set Connection” label
- ▶ “Serial Number” label

After reading these labels, the scanner will stay active for a specified period of time (2 minutes by default) trying to connect to the 3610 dongle while its LED is flashing blue (On/Off ratio 0.5 s: 0.5 s). Once connected, the scanner will respond with three beeps (tone ascending from low to high), and the LED becomes flashing blue (On/Off ratio 0.02 s: 3 s). When getting out of range, the scanner will respond with three short beeps (tone descending from high to low).

Read the “Set Connection” label first, and then the “Serial Number” label. If the “Set Connection” label on 3610 is illegible, try this one —

Set Connection



88686471166254

Note: The 3610 settings will overwrite the interface-related settings on the scanners that are currently connected to 3610.



3.1.2 CHANGE INTERFACE

If you want to change the interface 3610, use one of the connected scanners to configure the interface-related settings and it will pass the new settings to 3610, which will then initialize and pass the settings to any other connected scanners.

- 1) Have the scanners read the "Set Connection" and "Serial Number" labels at the back of 3610.
- 2) Within two minutes, connect 3610 to the USB port of PC. For USB Virtual COM, you may need to install its driver first!
- 3) The scanners will connect to your computer via 3610.
- 4) Have one scanner read the "Enter Setup" barcode to enter the configuration mode.
- 5) Have the scanner read the desired interface barcode and configure its related settings –
 - ▶ "Activate USB HID & Select Keyboard Type"
 - ▶ "Activate USB Virtual COM"
- 6) Have the scanner read the "Update" barcode to exit the configuration mode.
- 7) After the scanner resumes connection with 3610, it will pass the interface-related settings to 3610.
- 8) Upon receipt of the new settings, 3610 will initialize itself.
- 9) Updated with new settings, 3610 will pass the settings to other connected scanners.

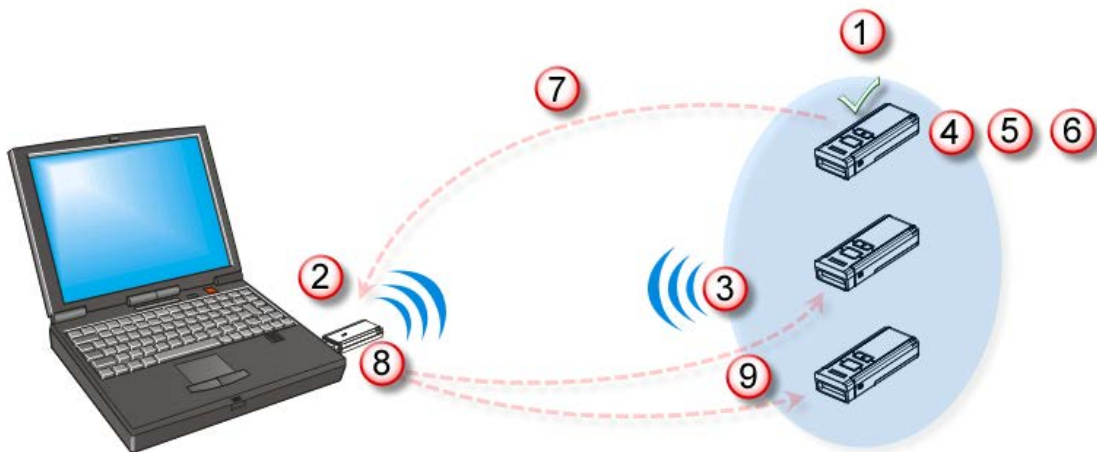

3.1.3 CONFIGURE RELATED SETTINGS

Sniff Mode (Power-saving)

By default, this feature is enabled, meaning the scanner will listen to the wireless network at a reduced rate.

***Enable**



100153

Disable



100152



3.2 CONNECTING VIA *BLUETOOTH*[®] DONGLE

3.2.1 CHANGE INTERFACE

Below is the procedure to configure the scanner before establishing a WPAN connection via *Bluetooth*[®] dongle.

- 1) Have the scanner read the “Enter Setup” barcode to enter the configuration mode.
- 2) Have the scanner read the desired interface barcode –
 - ▶ “Activate BT HID & Select Keyboard Type”
 - ▶ “Activate BT SPP Slave Mode”
 - ▶ “Activate BT SPP Master Mode”
- 3) Have the scanner read the barcodes related to WPAN settings, such as Device Name Broadcasting, Authentication & PIN Code, etc.
- 4) Have the scanner read the “Update” barcode to exit the configuration mode.
- 5) The scanner will stay active for a specified period of time (2 minutes by default) waiting for a connection request from the host (SPP Slave Mode) or trying to connect to the host (HID or SPP Master Mode). Its CPU is running at full speed, and the LED is flashing blue (On/Off ratio 0.5 s: 0.5 s).

Once connected, when getting out of range, the scanner will respond with three short beeps (tone descending from high to low).



3.2.2 CONFIGURE RELATED SETTINGS

Sniff Mode (Power-saving)

By default, this feature is enabled, meaning the scanner will listen to the wireless network at a reduced rate.

***Enable**



100153

Disable



100152

Note: When connecting more than two scanners to a notebook computer or PDA with *Bluetooth*[®] wireless technology, we suggest that you disable the power-saving setting for a more reliable connection.

Device Name Broadcasting

The scanner can be configured to hide itself from other devices equipped with *Bluetooth*[®] wireless technology. Simply disable the device name broadcasting setting so that it won't be discovered by any other computer or PDA. However, broadcasting must be enabled for establishing an initial connection with the scanner. For example, you can disable device name broadcasting after successfully connecting the scanner to WorkStation1. Such connection will be maintained automatically unless the scanner is removed from the paired device list (called unpairing) by WorkStation1 or any changes made to authentication and the PIN code. If you want WorkStation2 to connect to the scanner, you will have to enable device name broadcasting first.

***Enable**



100157

Disable



100156

Note: By default, device name broadcasting is enabled (which is required for initial connection).



Authentication

When any changes are made to authentication and PIN code on the scanner side, you will have to remove the scanner from the paired device list (called unpairing) and go through the whole process to re-establish the connection.

The scanner allows up to 16 characters for a PIN code and provides two options for authentication:

Enable Authentication with Preset PIN

Have the scanner read the “Use preset PIN” barcode, and change the preset PIN if necessary. This means you will have to enter exactly the same string for your computer or PDA to connect to the scanner. If the PIN or passkey is incorrect, any connection attempt will be turned down by the scanner. See step 8 in [3.2.3 Connect to Dongle](#).

1. Read the “Use preset PIN” barcode to enable authentication with a preset PIN.



2. Read one of the barcodes to specify the PIN code, in decimal or hexadecimal.

By default, the PIN code is set to “0000”. Maximum 16 characters are allowed.



3. Read the “[Decimal Value](#)” barcode on page 227 or the “[Hexadecimal Value](#)” barcode on page 228 for the desired digits or character string.

Read the “Clear PIN Code” barcode first if you need to re-input the PIN code.



4. Read the “Validate” barcode to complete this setting.

Enable Authentication with Random PIN or No Authentication

By default, it is set to “No PIN or use random PIN”, which depends on the setting of the target device. (No PIN = No authentication.)



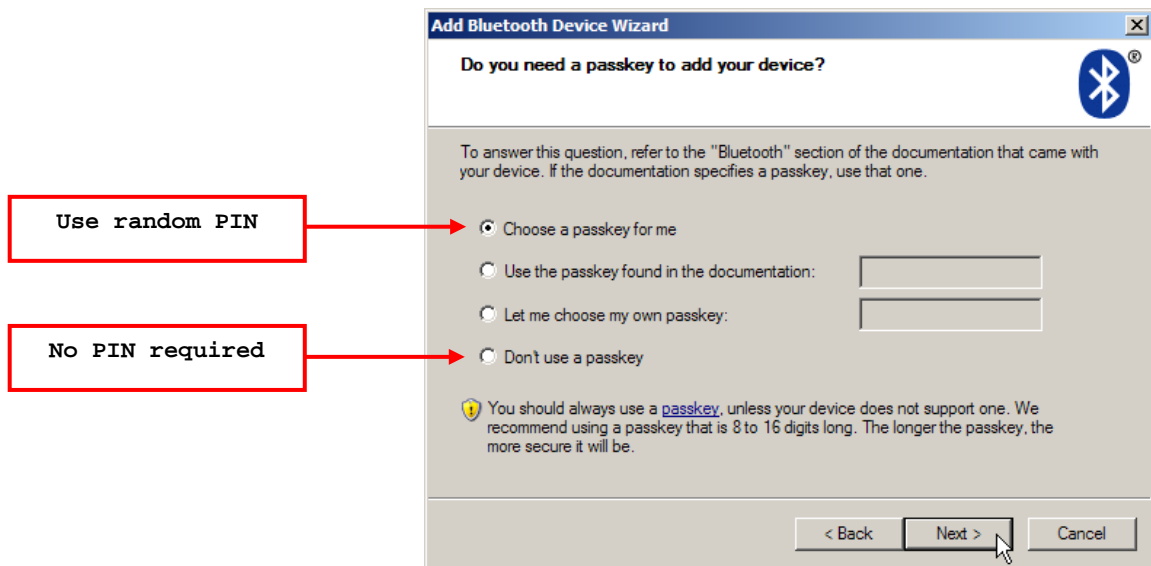

Note: When using BT HID, some device driver may not support pre-defined PIN code for authentication. In this case, make sure you have the scanner set to "No PIN or use random PIN" before pairing. While pairing, the host PIN code will be displayed on the computer screen. Have the scanner read the setup barcode "Enter PIN Code in Decimal" or "Enter PIN Code in Hexadecimal" to input the matching PIN code. Refer to [Disable Authentication or Use Random PIN](#).



3.2.3 CONNECT TO DONGLE

The procedure goes through associating devices for establishing a WPAN connection, which is pretty much the same except for the software you are using. If your computer is running Microsoft® Windows® XP Service Pack 3 (SP3) or Windows Vista® Service Pack 1 (SP1), you can use the software support that Windows® includes, or you can use the driver that the device manufacturer provides. Now, let's try using the software support that Windows® XP Service Pack 2 includes.

BT HID Procedure

By default, BT HID is activated on the scanner, and the keyboard type is set to PCAT (US). When BT HID is re-activated, you will have to select a keyboard type to complete this setting.

The procedure is the same as for BT SPP. Refer to steps 1~11 below.

BT SPP Slave Procedure

1. Turn on the *Bluetooth*® function on your computer, running Windows XP SP2.
2. Double-click the *Bluetooth*® icon from the lower right of the taskbar.  Alternatively, you may go to **Control Panel > Bluetooth Devices**.
3. Click [Add] to search devices nearby.

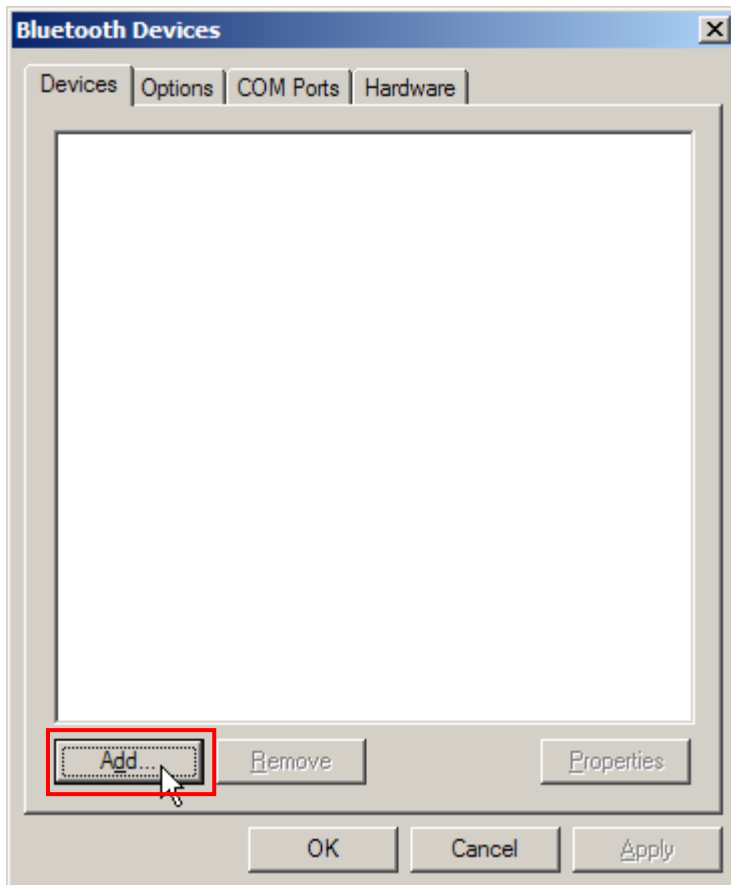

4. Turn on the scanner with correct WPAN settings, such as select BT SPP or BT HID, broadcasting enabled, authentication enabled, and PIN code specified, etc. Select the check box of [My device is set up and ready to be found] on your computer.
5. Click [Next].



6. Wait for a few seconds for the Wizard to search available devices nearby.
The scanner will appear with its "serial number" as the device name. You may double-check the "Serial Number" label on the scanner to ensure connecting with the correct scanner. Select the target scanner. If the target scanner does not appear on the list, click [Search Again] to refresh the list. The scanner might enter Suspend Mode now, and you can press the trigger to have it active again (=discoverable). It will then stay active for a specified period of time (2 minutes by default) and wait for PC to establish a connection.



7. Click [Next].

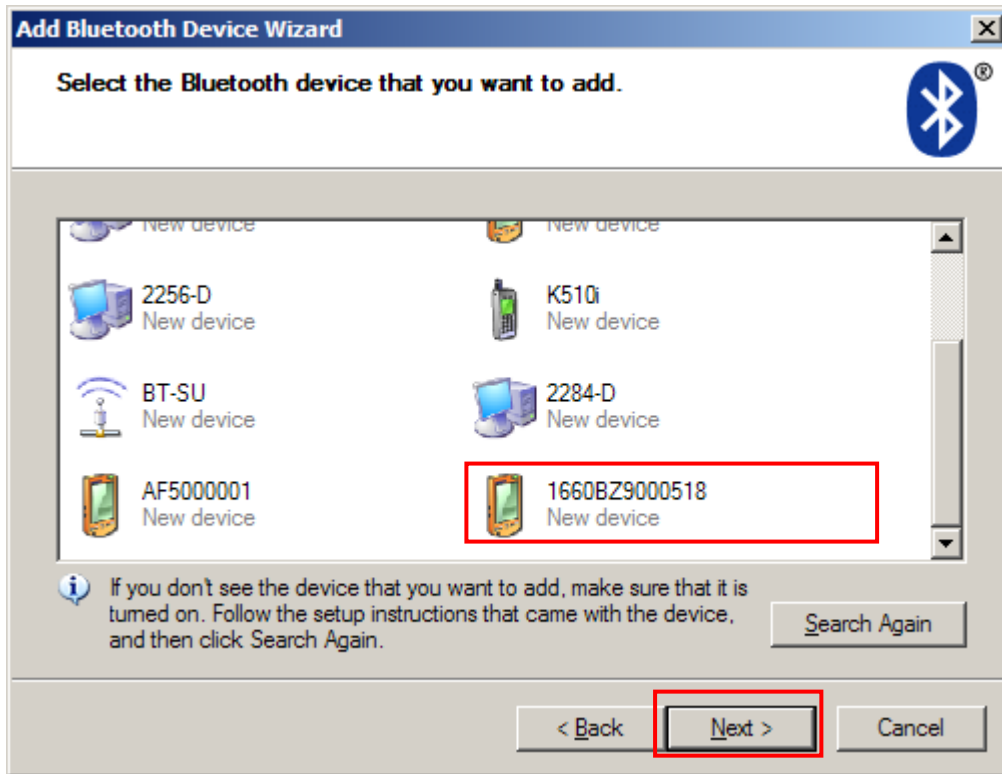

8. Enter the passkey for authentication, which must be exactly the same as configured for the scanner.



- 9. Click [Next]. Wait for a few seconds for Windows to exchange passkeys.

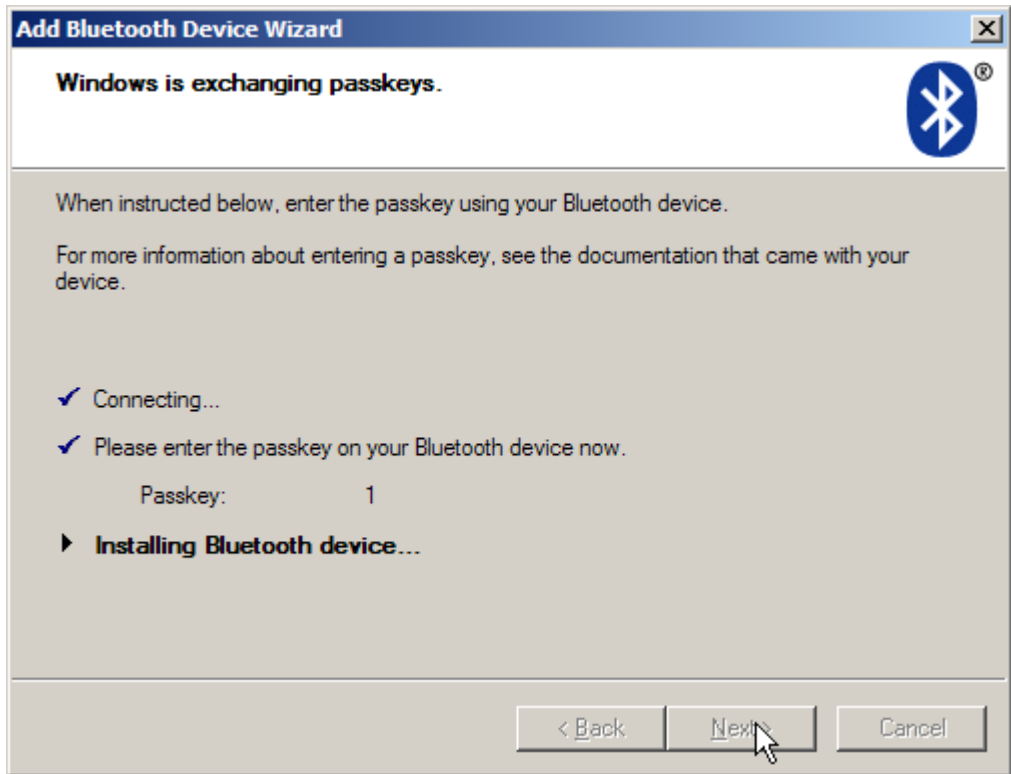
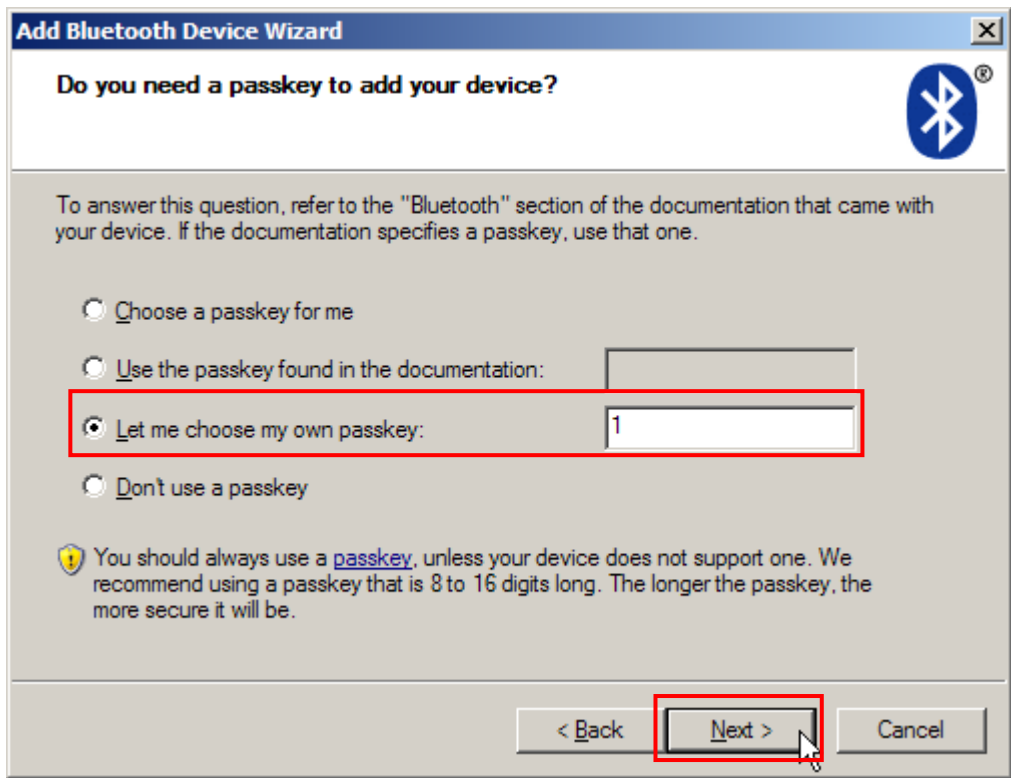

Note: When Bluetooth security is enabled without providing a pre-set PIN code, dynamic input of PIN code is supported.

10. Click [Finish].

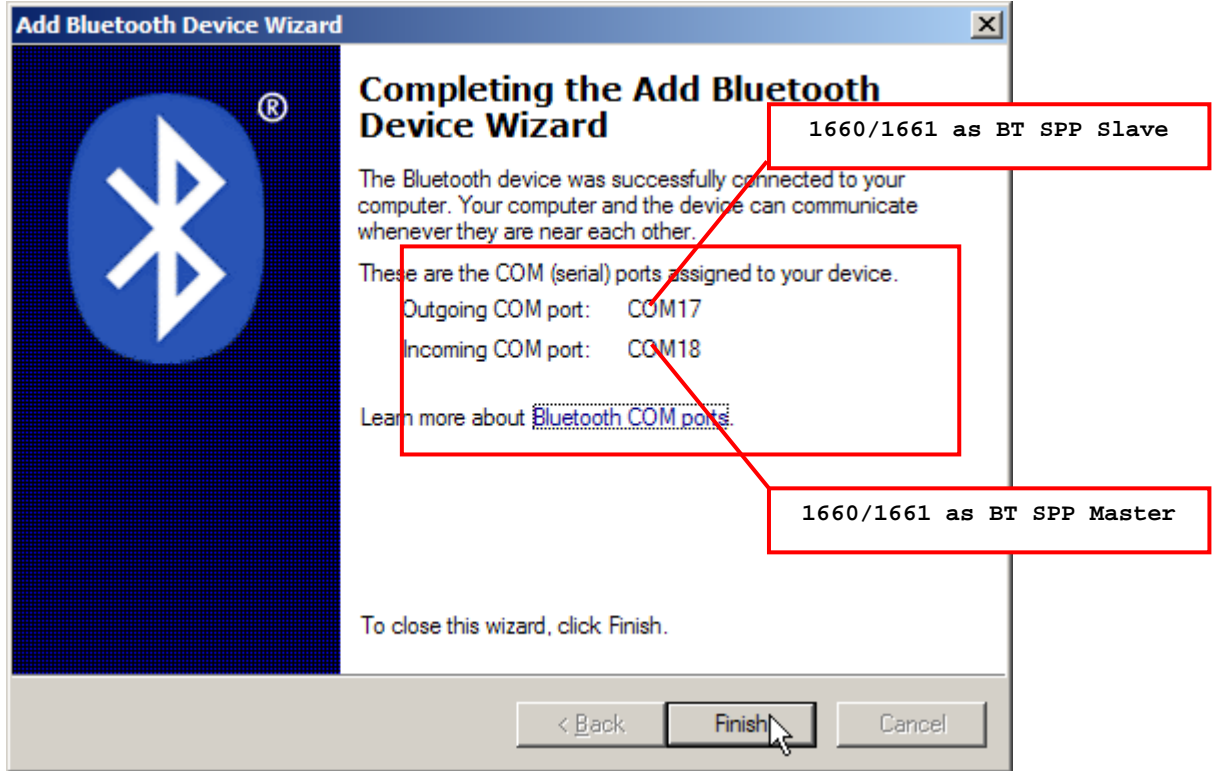

11. Now the target scanner will be listed as shown below.

You can have up to seven scanners connected to one computer at the same time.

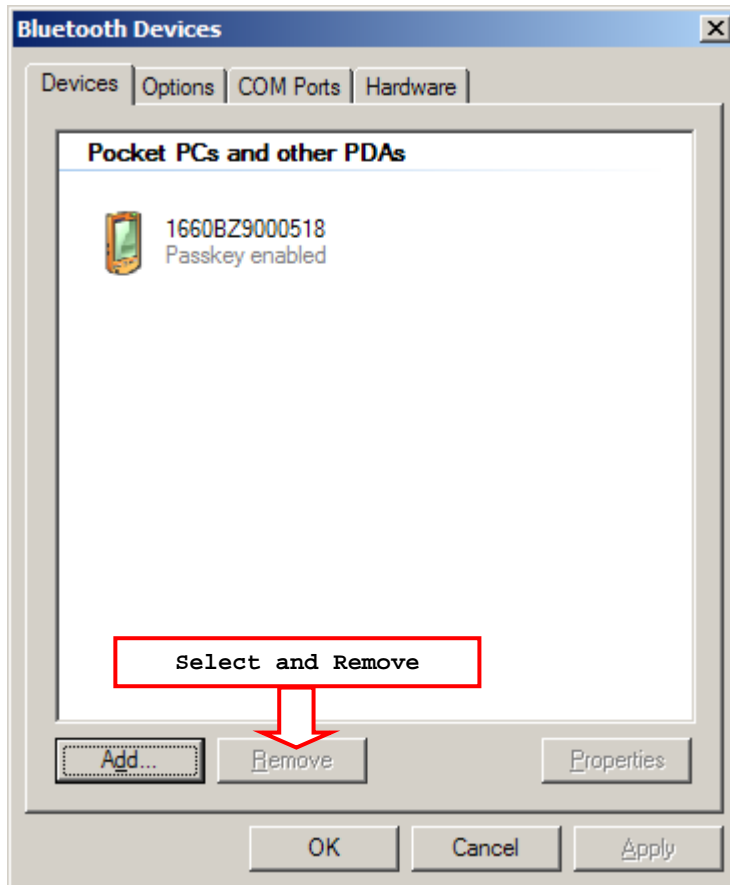

Note: When any changes are made to authentication and PIN code on the scanner side, or you want to change to use BT HID, it is suggested that you remove the scanner from the paired device list (called unpairing) and go through the whole process to re-establish the connection.

12. Run the desired application on your computer, such as HyperTerminal.exe if using BT SPP or Notepad.exe if using BT HID.

The status of the scanner listed on the device list will be updated to "Connected", indicating the WPAN connection is established successfully via the outgoing COM port if using BT SPP.

Note: Even though the scanner is connected to the host with authentication disabled (= no PIN code required), the host may still request a PIN code while the application is opening COM port. Dynamic input of PIN code is supported so that you may input a matching PIN code on the scanner. Refer to [Disable Authentication or Use Random PIN](#).



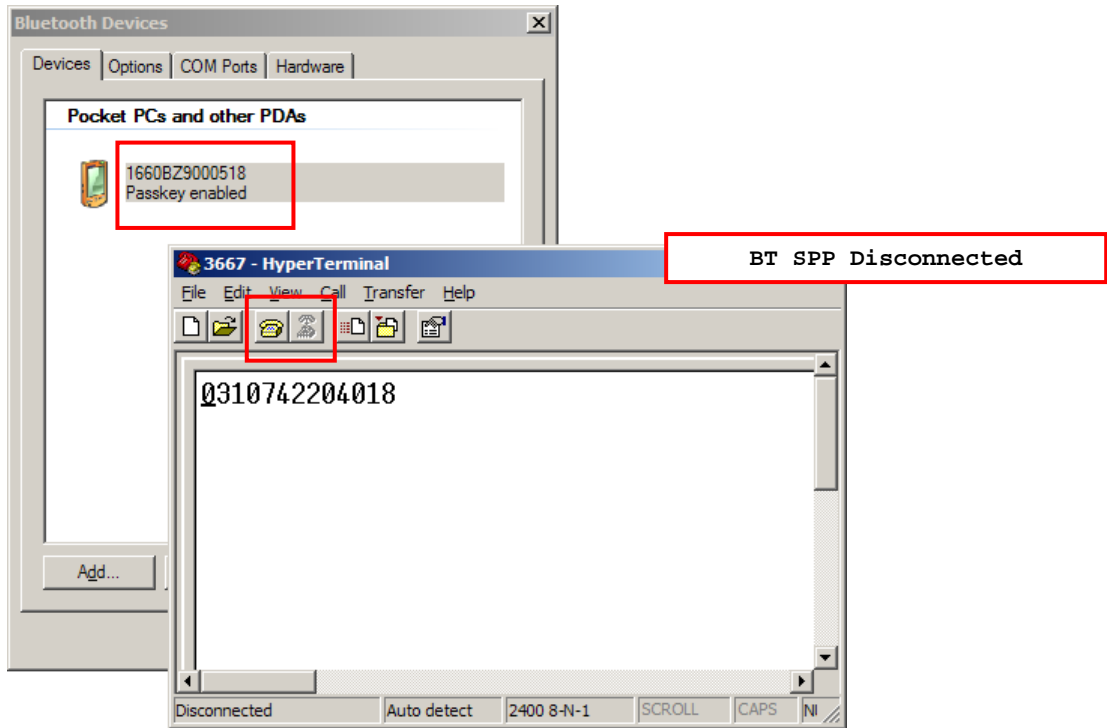
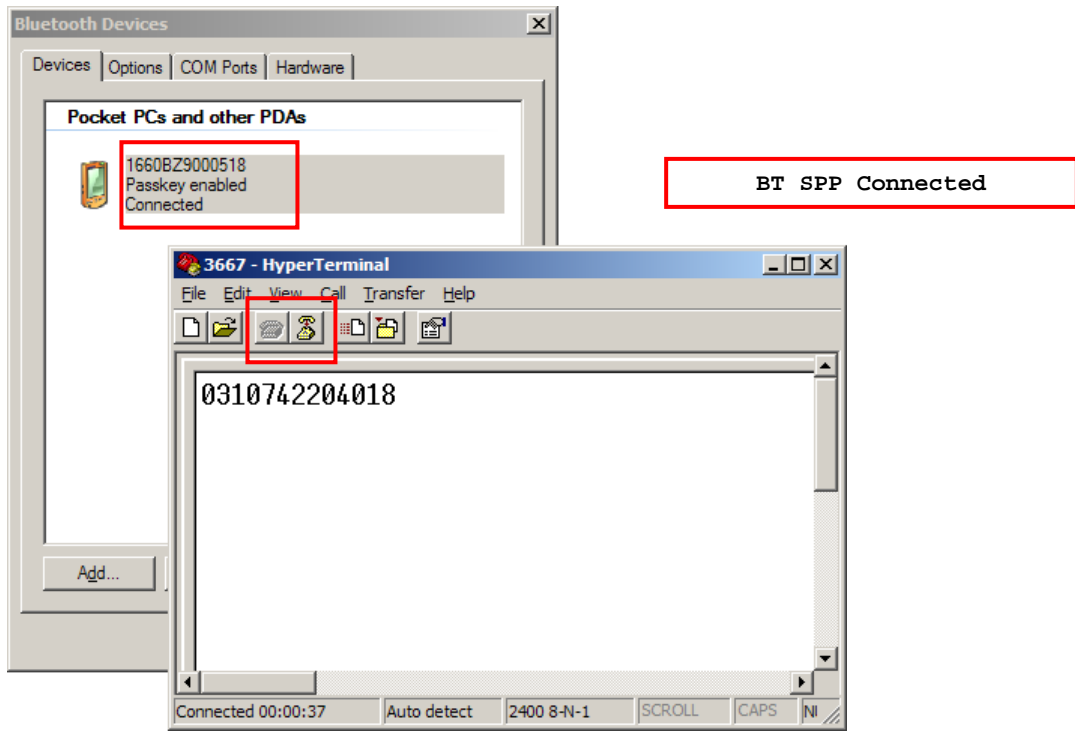



CHANGING SYMBOLOGY SETTINGS

In this chapter, a brief on the symbology settings is provided for your reference.

IN THIS CHAPTER

4.1 Codabar.....	116
4.2 Code 25 - Industrial 25.....	118
4.3 Code 25 - Interleaved 25.....	121
4.4 Code 25 - Matrix 25.....	124
4.5 Code 39.....	127
4.6 Code 93.....	129
4.7 Code 128.....	129
4.8 EAN-8.....	130
4.9 EAN-13.....	132
4.10 GS1-128 (EAN-128).....	135
4.11 ISBT 128.....	137
4.12 MSI.....	138
4.13 French Pharmacode.....	140
4.14 Italian Pharmacode.....	141
4.15 Plessey.....	142
4.16 GS1 DataBar (RSS Family).....	143
4.17 Telepen.....	149
4.18 UPC-A.....	150
4.19 UPC-E.....	152



4.1 CODABAR



4.1.1 SECURITY LEVEL

The scanner allows you to adjust the CODABAR security level between high or normal level.

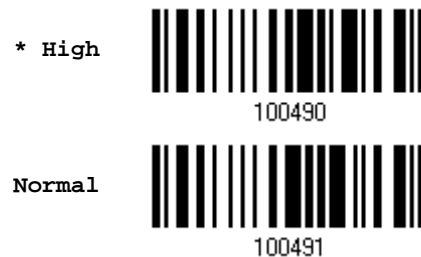

4.1.2 START/STOP CHARACTERS SELECTION

Select one of the four different start/stop character pairs –



4.1.3 START/STOP TRANSMISSION

Decide whether to include the start/stop characters in the data being transmitted.



4.1.4 CLSI CONVERSION

When enabled, the CLSI editing strips the start/stop characters and inserts a space after the first, fifth, and tenth characters of a 14-character Codabar barcode.

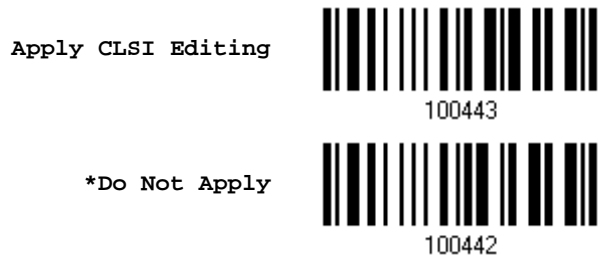

Note: The 14-character barcode length does not include start/stop characters.



4.2 CODE 25 – INDUSTRIAL 25



4.2.1 START/STOP PATTERN SELECTION

This decides the readability of all 2 of 5 symbology variants. For example, flight tickets actually use an Industrial 2 of 5 barcode but with Interleaved 2 of 5 start/stop pattern. In order to read this barcode, the start/stop pattern selection parameter of Industrial 2 of 5 should set to "Interleaved 25".

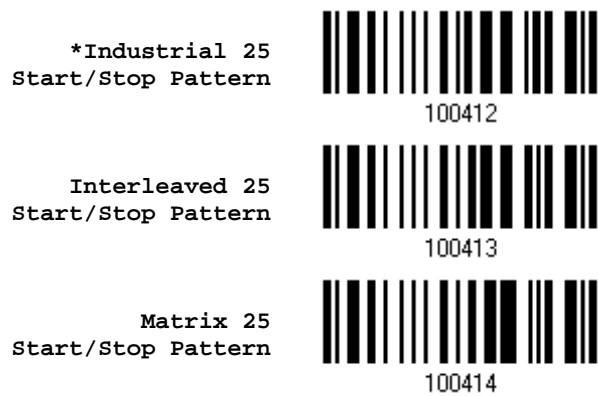

4.2.2 VERIFY CHECK DIGIT

Decide whether to verify the check digit. If incorrect, the barcode will not be accepted.

Verify Industrial 25
Check Digit



100425

*Do Not Verify



100424

4.2.3 TRANSMIT CHECK DIGIT

Decide whether to include the check digit in the data being transmitted.

*Transmit
Industrial 25
Check Digit



100427

Do Not Transmit



100426



4.2.4 CODE LENGTH QUALIFICATION

To prevent the "short scan" error, define the "Length Qualification" settings to ensure that the correct barcode is read by qualifying the allowable code length.

- ▶ If "Max/Min Length" is selected, the maximum length and the minimum length must be specified. It only accepts those barcodes with lengths that fall between max/min lengths specified.
- ▶ If "Fixed Length" is selected, up to 2 fixed lengths can be specified.

1) Read the barcode to enable either Max. /Min. Length qualification or Fixed Length(s) qualification.

***Enable Max./Min.
Length (0~127)...**



100601

**Enable Fixed
Length(s)...**



100600

2) Read the barcode for Max. Length or Fixed Length 1, and follow steps 3~4.

Repeat steps 2~4 for Min. Length or Fixed Length 2.

**Max. Length (*127) or
Fixed Length 1**



100602

**Min. Length (*4) or
Fixed Length 2**



100603

3) Read the "[Decimal Value](#)" barcode on page 227 for the desired length.

4) Read the "Validate" barcode on the same page to complete this setting.



4.3 CODE 25 – INTERLEAVED 25

*Enable



100309

Disable



100308

4.3.1 START/STOP PATTERN SELECTION

This decides the readability of all 2 of 5 symbology variants. For example, flight tickets actually use an Industrial 2 of 5 barcode but with Interleaved 2 of 5 start/stop pattern. In order to read this barcode, the start/stop pattern selection parameter of Industrial 2 of 5 should be set to "Interleaved 25".

Industrial 25
Start/Stop Pattern



100416

*Interleaved 25
Start/Stop Pattern



100417

Matrix 25
Start/Stop Pattern



100418



4.3.2 VERIFY CHECK DIGIT

Decide whether to verify the check digit. If incorrect, the barcode will not be accepted.

Verify
Interleaved 25
Check Digit



*Do Not Verify



4.3.3 TRANSMIT CHECK DIGIT

Decide whether to include the check digit in the data being transmitted.

*Transmit
Interleaved 25
Check Digit



Do Not Transmit



4.3.4 CODE LENGTH QUALIFICATION

To prevent the "short scan" error, define the "Length Qualification" settings to ensure that the correct barcode is read by qualifying the allowable code length.

- ▶ If "Max/Min Length" is selected, the maximum length and the minimum length must be specified. It only accepts those barcodes with lengths that fall between max/min lengths specified.
- ▶ If "Fixed Length" is selected, up to 2 fixed lengths can be specified.

- 1) Read the barcode to enable either Max. /Min. Length qualification or Fixed Length(s) qualification.

*Enable Max./Min.
Length (0~127)...



100605

Enable Fixed
Length(s)...



100604

- 2) Read the barcode for Max. Length or Fixed Length 1, and follow steps 3~4.
Repeat steps 2~4 for Min. Length or Fixed Length 2.

Max. Length (*126) or
Fixed Length 1



100606

Min. Length (*4) or
Fixed Length 2



100607

- 3) Read the "[Decimal Value](#)" barcode on page 227 for the desired length.
- 4) Read the "Validate" barcode on the same page to complete this setting.



4.4 CODE 25 – MATRIX 25

Enable



100311

*Disable



100310

4.4.1 START/STOP PATTERN SELECTION

This decides the readability of all 2 of 5 symbology variants. For example, flight tickets actually use an Industrial 2 of 5 barcode but with Interleaved 2 of 5 start/stop pattern. In order to read this barcode, the start/stop pattern selection parameter of Industrial 2 of 5 should set to "Interleaved 25".

Industrial 25
Start/Stop Pattern



100420

Interleaved 25
Start/Stop Pattern



100421

*Matrix 25
Start/Stop Pattern



100422



4.4.2 VERIFY CHECK DIGIT

Decide whether to verify the check digit. If incorrect, the barcode will not be accepted.

Verify Matrix 25
Check Digit



100433

*Do Not Verify



100432

4.4.3 TRANSMIT CHECK DIGIT

Decide whether to include the check digit in the data being transmitted.

*Transmit Matrix 25
Check Digit



100435

Do Not Transmit



100434



4.4.4 CODE LENGTH QUALIFICATION

To prevent the "short scan" error, define the "Length Qualification" settings to ensure that the correct barcode is read by qualifying the allowable code length.

- ▶ If "Max/Min Length" is selected, the maximum length and the minimum length must be specified. It only accepts those barcodes with lengths that fall between max/min lengths specified.
- ▶ If "Fixed Length" is selected, up to 2 fixed lengths can be specified.

1) Read the barcode to enable either Max. /Min. Length qualification or Fixed Length(s) qualification.

*Enable Max./Min.
Length (0~127)...



100609

Enable Fixed
Length(s)...



100608

2) Read the barcode for Max. Length or Fixed Length 1, and follow steps 3~4.

Repeat steps 2~4 for Min. Length or Fixed Length 2.

Max. Length (*127) or
Fixed Length 1



100610

Min. Length (*4) or
Fixed Length 2



100611

3) Read the "[Decimal Value](#)" barcode on page 227 for the desired length.

4) Read the "Validate" barcode on the same page to complete this setting.



4.5 CODE 39

*Enable



100301

Disable



100300

4.5.1 START/STOP TRANSMISSION

Decide whether to include the start/stop characters in the data being transmitted.

Transmit Code 39
Start/Stop
Characters



100403

*Do Not Transmit



100402

4.5.2 VERIFY CHECK DIGIT

Decide whether to verify check digit. If incorrect, the barcode will not be accepted.

Verify Code 39
Check Digit



100405

*Do Not Verify



100404



4.5.3 TRANSMIT CHECK DIGIT

Decide whether to include the check digit in the data being transmitted.

*Transmit Code 39
Check Digit



100407

Do Not Transmit



100406

4.5.4 STANDARD/FULL ASCII CODE 39

Decide whether to support Code 39 Full ASCII that includes all the alphanumeric and special characters.

Code 39 Full ASCII



100401

*Standard Code 39



100400

4.5.5 SECURITY LEVEL

Decide the security level of Code 39.

*High



100488

Normal



100489



4.6 CODE 93

***Enable**



100315

Disable



100314

4.7 CODE 128

***Enable**



100317

Disable



100316

4.7.1 SECURITY LEVEL

Decide the security level of Code 39.

***High**



100492

Normal



100493



4.8 EAN-8

EAN-8

***Enable EAN-8
(No Addon)**



100327

Disable



100326

EAN-8 Addon 2

Enable EAN-8 Addon 2



100329

***Disable**



100328

EAN-8 Addon 5

Enable EAN-8 Addon 5



100331

***Disable**



100330



4.8.1 CONVERT TO EAN-13

Decide whether to expand the read EAN-8 barcode, as well as its addons, into EAN-13.

- ▶ After conversion, the data follows EAN-13 format and is affected by EAN-13 programming selections (e.g. Check Digit).

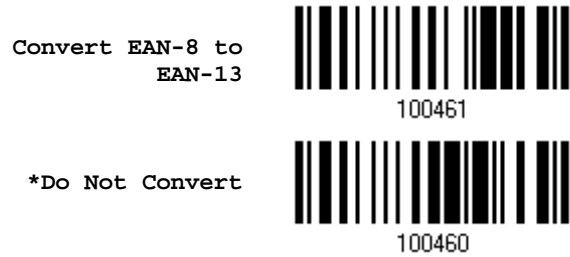

4.8.2 TRANSMIT CHECK DIGIT

Decide whether to include the check digit in the data being transmitted.

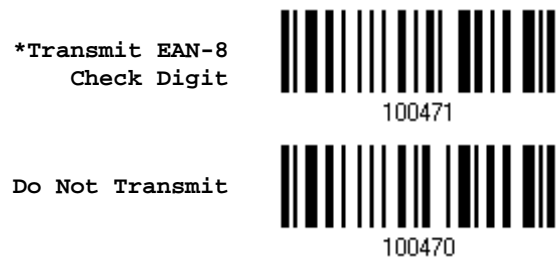

4.8.3 CONVERSION FORMAT

When converting EAN-8 to EAN-13, you can scan the barcode below to decide conversion in default or GTIN-13 format.



4.9 EAN-13

EAN-13

***Enable EAN-13
(No Addon)**



Disable



EAN-13 Addon 2

Enable EAN-13 Addon 2



***Disable**



EAN-13 Addon 5

Enable EAN-13 Addon 5



***Disable**



4.9.1 ISBN CONVERSION

Decide whether to convert the EAN-13 barcode, starting with 978 and 979, to ISBN.

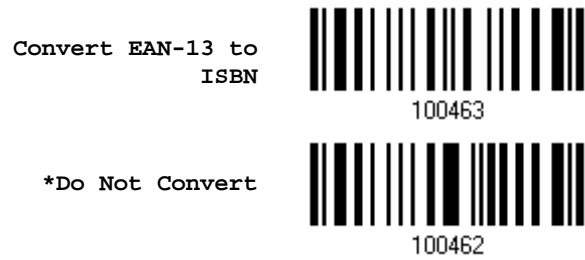

4.9.2 ISSN CONVERSION

Decide whether to convert the EAN-13 barcode, starting with 977 to ISSN.

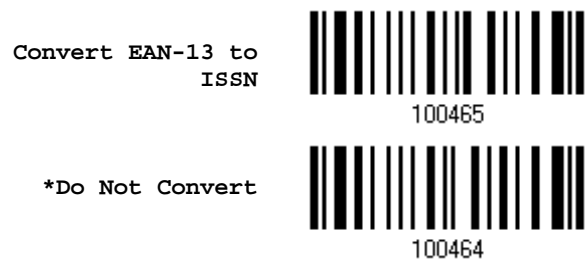

4.9.3 TRANSMIT CHECK DIGIT

Decide whether to include the check digit in the data being transmitted.

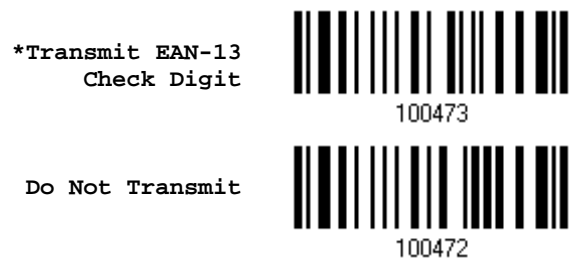

4.9.4 SECURITY LEVEL

Select the security level for reading EAN-13 barcodes.

Normal



100487

*High



100486



4.10 GS1-128 (EAN-128)

*Enable



100319

Disable



100318

Note: GS1-128 barcodes can be decoded only when this setting is enabled. However, for 1660 with firmware version no later than 1.30, GS1-128 barcodes are taken as Code 128 when this setting is disabled.

4.10.1 CODE ID TRANSMISSION

Decide whether to include the Code ID ("1c1") in the data being transmitted.

Transmit Code ID



100519

*Do Not Transmit



100518

4.10.2 FIELD SEPARATOR (GS CHARACTER)

Decide whether to apply a field separator (to convert the FNC1 control character to human readable character).

Specify Field
Separator...



100616

- 1) Read the barcode above to specify field separator.
- 2) Read the "[Hexadecimal Value](#)" barcode on page 228 for the desired character string.
- 3) Read the "Validate" barcode to complete this setting.

Note: GS1-128 barcodes start with the FNC1 control character to distinguish themselves from other uses of Code 128. FNC1 is also used to separate data fields in the GS1-128 barcodes.



4.10.3 GS1 FORMATTING

Decide whether to enable GS1 formatting for GS1-128. When enabled, code ID transmission will be disabled; however, the field separator and application ID mark characters will be automatically added to the output data.



You may want to add an application ID mark (1 character long) to the left (AIMark1) or right (AIMark2) of an application ID (AI) for the purpose of labeling it when formatting the GS1 data.

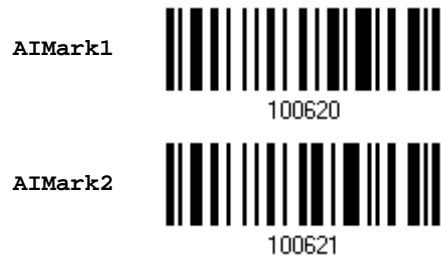

- 1) Read the barcode above to add a mark to the left (AIMark1)/right (AIMark2) of an application ID.
- 2) Read the "[Hexadecimal Value](#)" barcode on page 228 for the desired character. Read '00' if you want to remove the AI mark.
- 3) Read the "Validate" barcode to complete this setting.



4.11 ISBT 128



Note: When enabled, it not only can decode single ISBT barcode, but also decode and concatenates pairs of ISBT barcodes.

4.11.1 ISBT CONCATENATION

Decide whether to decode and concatenate pairs of ISBT barcodes.

- ▶ **Auto-discriminate ISBT Concatenation**

It decodes and concatenates pairs of ISBT barcodes immediately. If only a single ISBT barcode is present, the scanner must decode 10 times before transmitting its data to confirm that there is no additional ISBT barcode.

- ▶ **Enable ISBT Concatenation**

There must be two ISBT barcodes in order for the scanner to decode and perform concatenation. It does not decode single ISBT barcodes.

- ▶ **Disable ISBT Concatenation**

It will not concatenate pairs of ISBT barcodes it encounters.



4.12 MSI

Enable



100345

*Disable



100344

4.12.1 VERIFY CHECK DIGIT

Select one of the three calculations to verify check digit when decoding barcodes. If incorrect, the barcode will not be accepted.

*Single Modulo 10



100448

Double Modulo 10



100449

Modulo 10 & 11



100450

4.12.2 TRANSMIT CHECK DIGIT

Decide whether to include the check digit in the data being transmitted.

*Last Digit Not Transmitted



100452

Both Digits Transmitted



100453

Both Digits Not Transmitted



100454



4.12.3 CODE LENGTH QUALIFICATION

To prevent the "short scan" error, define the "Length Qualification" settings to ensure that the correct barcode is read by qualifying the allowable code length.

- ▶ If "Max/Min Length" is selected, the maximum length and the minimum length must be specified. It only accepts those barcodes with lengths that fall between max/min lengths specified.
- ▶ If "Fixed Length" is selected, up to 2 fixed lengths can be specified.

- 1) Read the barcode to enable either Max. /Min. Length qualification or Fixed Length(s) qualification.

***Enable Max./Min.
Length (0~127)...**



100613

**Enable Fixed
Length(s)...**



100612

- 2) Read the barcode for Max. Length or Fixed Length 1, and follow steps 3~4.
Repeat steps 2~4 for Min. Length or Fixed Length 2.

**Max. Length (*127) or
Fixed Length 1**



100614

**Min. Length (*4) or
Fixed Length 2**



100615

- 3) Read the "[Decimal Value](#)" barcode on page 227 for the desired length.
- 4) Read the "Validate" barcode on the same page to complete this setting.



4.13 FRENCH PHARMACODE

Enable



100305

*Disable



100304

4.13.1 TRANSMIT CHECK DIGIT

Decide whether to include the check digit in the data being transmitted.

*Transmit
French Pharmacode
Check Digit



100411

Do Not Transmit



100410



4.14 ITALIAN PHARMACODE

Enable



100303

*Disable



100302

4.14.1 TRANSMIT CHECK DIGIT

Decide whether to include the check digit in the data being transmitted.

*Transmit
Italian Pharmacode
Check Digit



100409

Do Not Transmit



100408



4.15 PLESSEY

Enable



100347

*Disable



100346

4.15.1 CONVERT TO UK PLESSEY

Decide whether to change each occurrence of the character 'A' to character 'X' in the decoded data.

Convert to UK Plessey



100447

*Do Not Convert



100446

4.15.2 TRANSMIT CHECK DIGIT

Decide whether to include the two check digits in the data being transmitted.

*Transmit Plessey
Check Digits



100445

Do Not Transmit



100444



4.16 GS1 DATABAR (RSS FAMILY)

It is categorized into three groups:

Group I – GS1 DataBar Omnidirectional (RSS-14)

This group consists of the following:

- ▶ GS1 DataBar Omnidirectional
- ▶ GS1 DataBar Truncated
- ▶ GS1 DataBar Stacked
- ▶ GS1 DataBar Stacked Omnidirectional

Group II – GS1 DataBar Expanded (RSS Expanded)

This group consists of the following:

- ▶ GS1 DataBar Expanded
- ▶ GS1 DataBar Expanded Stacked

Group III – GS1 DataBar Limited (RSS Limited)

This group consists of the following:

- ▶ GS1 DataBar Limited

4.16.1 CODE ID SELECTION

Select a desired Code ID to use:

- ▶ "]e0" (GS1 DataBar Code ID)
- ▶ "]c1" (GS1-128 Code ID)

Use "]c1"



100517

*Use "]e0"



100516



4.16.2 GS1 DATABAR OMNIDIRECTIONAL (RSS-14)

Enable RSS-14 &
RSS Expanded
(Groups I, II)



*Disable



When GS1 formatting for GS1 DataBar Omnidirectional is enabled, code ID transmitting will be disabled; however, the application ID and check digit transmitting will be enabled automatically.

The settings below apply to Group I symbologies only:

- ▶ GS1 DataBar Omnidirectional
- ▶ GS1 DataBar Truncated
- ▶ GS1 DataBar Stacked
- ▶ GS1 DataBar Stacked Omnidirectional

Transmit Code ID

Decide whether to include the Code ID in the data being transmitted.

*Transmit RSS-14
Code ID



Do Not Transmit



Transmit Application ID

Decide whether to include the Application ID ("01") in the data being transmitted.

*Transmit RSS-14
Application ID



Do Not Transmit



Transmit Check Digit

Decide whether to include the check digit in the data being transmitted.

*Transmit RSS-14
Check Digit



Do Not Transmit



4.16.3 GS1 DATABAR EXPANDED (RSS EXPANDED)

Enable RSS-14 &
RSS Expanded
(Groups I, II)



*Disable



When GS1 formatting for GS1 DataBar Expanded is enabled, code ID transmitting will be disabled automatically.

The settings below apply to Group II symbologies only:

- ▶ GS1 DataBar Expanded
- ▶ GS1 DataBar Expanded Stacked

Transmit Code ID

Decide whether to include the Code ID in the data being transmitted.

*Transmit
RSS Expanded Code ID



Do Not Transmit



4.16.4 GS1 DATABAR LIMITED (RSS LIMITED)

Enable RSS Limited
(Group III)



100351

*Disable



100350

When GS1 formatting for GS1 DataBar Limited is enabled, code ID transmitting will be disabled; however, the application ID and check digit transmitting will be enabled automatically.

Transmit Code ID

Decide whether to include the Code ID in the data being transmitted.

*Transmit
RSS Limited Code ID



100525

Do Not Transmit



100524

Transmit Application ID

Decide whether to include the Application ID ("01") in the data being transmitted.

*Transmit
RSS Limited
Application ID



100531

Do Not Transmit



100530

Transmit Check Digit

Decide whether to include the check digit in the data being transmitted.

*Transmit
RSS Limited
Check Digit



100483

Do Not Transmit



100482



4.16.5 FIELD SEPARATOR (GS CHARACTER)

Decide whether to apply a field separator (to convert the GS control character to human readable character).

Specify Field
Separator...



- 1) Read the barcode above to specify field separator.
- 2) Read the "[Hexadecimal Value](#)" barcode on page 228 for the desired character string.
- 3) Read the "Validate" barcode to complete this setting.

4.16.6 GS1 FORMATTING

Decide whether to enable GS1 formatting for GS1 DataBar (RSS family). When enabled, the field separator and application ID mark characters will be automatically added to the output data.

Enable



*Disable



You may want to add an application ID mark (1 character long) to the left (AIMark1) or right (AIMark2) of an application ID (AI) for the purpose of labeling it when formatting the GS1 data.

AIMark1



AIMark2



- 1) Read the barcode above to add a mark to the left (AIMark1)/right (AIMark2) of an application ID.
- 2) Read the "[Hexadecimal Value](#)" barcode on page 228 for the desired character. Read '00' if you want to remove the AI mark.
- 3) Read the "Validate" barcode to complete this setting.



4.17 TELEPEN

Enable Telepen



100353

*Disable



100352

4.17.1 TELEPEN OUTPUT - FULL ASCII/NUMERIC

Decide whether to support Telepen in full ASCII code. By default, it supports ASCII mode.

- ▶ AIM Telepen (Full ASCII) includes all the alphanumeric and special characters.

Original Telepen
(Numeric)



100485

*AIM Telepen



100484



4.18 UPC-A

UPC-A

***Enable UPC-A
(No Addon)**



100339

Disable



100338

UPC-A Addon 2

Enable UPC-A Addon 2



100341

***Disable**



100340

UPC-A Addon 5

Enable UPC-A Addon 5



100343

***Disable**



100342



4.18.1 CONVERT TO EAN-13

Decide whether to expand the read UPC-A barcode, as well as its addons, into EAN-13.

- ▶ After conversion, the data follows EAN-13 format and is affected by EAN-13 programming selections (e.g. Check Digit).

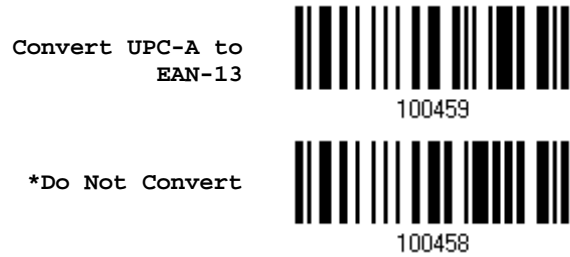

4.18.2 SYSTEM NUMBER TRANSMISSION

Decide whether to include the system number in the data being transmitted.

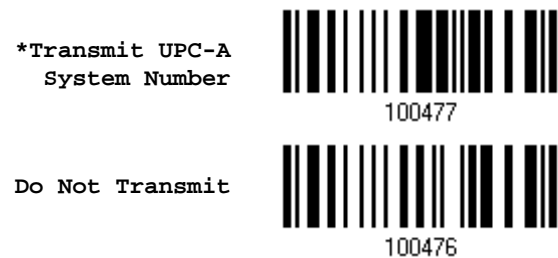

4.18.3 TRANSMIT CHECK DIGIT

Decide whether to include the check digit in the data being transmitted.

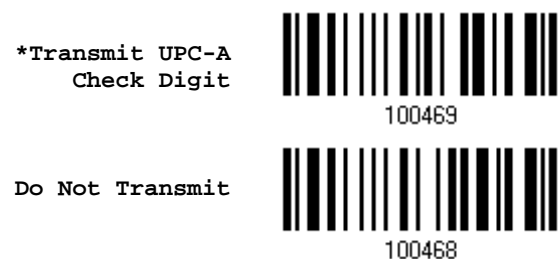

4.19 UPC-E

UPC-E

***Enable UPC-E
(No Addon)**



100321

Disable



100320

UPC-E Addon 2

Enable UPC-E Addon 2



100323

***Disable**



100322

UPC-E Addon 5

Enable UPC-E Addon 5



100325

***Disable**



100324



4.19.1 SYSTEM NUMBER SELECTION

Decide whether to decode the ordinary UPC-E barcodes only or both UPC-E0 and UPC-E1 barcodes.

- ▶ System number 0 enabled for decoding UPC-E0 barcodes.
- ▶ System number 1 enabled for decoding UPC-E1 barcodes.

System Number 0 & 1



100479

*System Number 0 Only



100478

Warning: Because of the way system number 1 is encoded, if both system numbers are enabled, the user might suffer from short scanning UPC-A or EAN-13 barcodes into UPC-E1 barcodes.

4.19.2 CONVERT TO UPC-A

Decide whether to expand the read UPC-E barcode, as well as its addons, into UPC-A.

- ▶ After conversion, the data follows UPC-A format and is affected by UPC-A programming selections (e.g. System Number, Check Digit).

Convert UPC-E to
UPC-A



100457

*Do Not Convert



100456



4.19.3 SYSTEM NUMBER TRANSMISSION

Decide whether to include the system number in the data being transmitted.

Transmit UPC-E
System Number



100475

*Do Not Transmit



100474

4.19.4 TRANSMIT CHECK DIGIT

Decide whether to include the check digit in the data being transmitted.

*Transmit UPC-E
Check Digit



100467

Do Not Transmit



100466



DEFINING OUTPUT FORMAT

You may configure in which format the collected data will be output to the host computer. Barcode read by the scanner will be processed in the following sequence –

- 1) Perform character substitution on the data scanned.
- 2) Add [Code ID](#) and [Length Code](#) to the front of the data: [Code ID][Length Code][Data]
- 3) Process the whole data in step 2 with user formats. Data is now divided into fields by user specified rules. Refer to [Chapter 6 Applying Formats for Data Editing](#).
- 4) Add [Prefix Code](#) and [Suffix Code](#) before transmission: [Prefix Code][Processed Data][Suffix Code]

IN THIS CHAPTER

5.1 Letter Case	155
5.2 Character Substitution	156
5.3 Prefix/Suffix Code	164
5.4 Code ID	165
5.5 Length Code	169
5.6 Multi-Barcode Editor	173
5.7 Removal of Special Character	176

5.1 LETTER CASE

By default, the alphabets transmission is case-sensitive, meaning that the alphabets will be transmitted according to their original case. Ignoring the original letter case, select [Upper Case] to output data in upper case only; otherwise, select [Lower Case] to output data in lower case only.

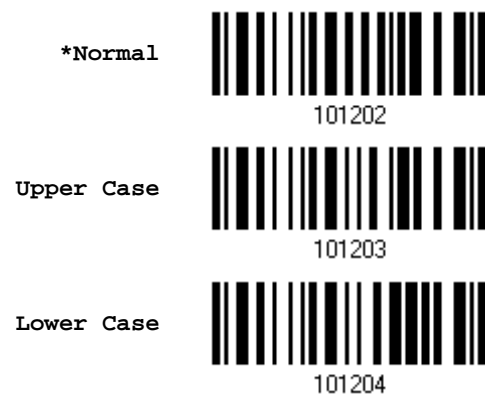

5.2 CHARACTER SUBSTITUTION

Character substitution is performed on every occurrence of the first character specified. If only one character is specified, every occurrence of that character in the barcode will be taken away.

- ▶ The first character will be replaced by the second character(s).
- ▶ Up to three sets of character substitution can be configured.
- ▶ If "BT HID" or "USB HID" is configured for interface, [Key Type](#) and [Key Status](#) will then become applicable. You may decide whether or not to apply Key Status when "Normal Key" is selected for Key Type.

Key Type		Key Status
Scan Code	Only 1 scan code value is allowed. Refer to 5.2.1 Select a Set for Character Substitution .	N/A
Normal Key	Up to 3 character strings are allowed.	<ul style="list-style-type: none"> ▶ Add Shift ▶ Add Left Ctrl ▶ Add Left Alt ▶ Add Right Ctrl ▶ Add Right Alt Refer to Keyboard Wedge Table .

Note: The character substitution is performed only on the barcode itself and before the processing of editing formats. It is not applicable to the Prefix/Suffix Code, Code ID, Length Code, or any Additional Field.



5.2.1 SELECT A SET FOR CHARACTER SUBSTITUTION

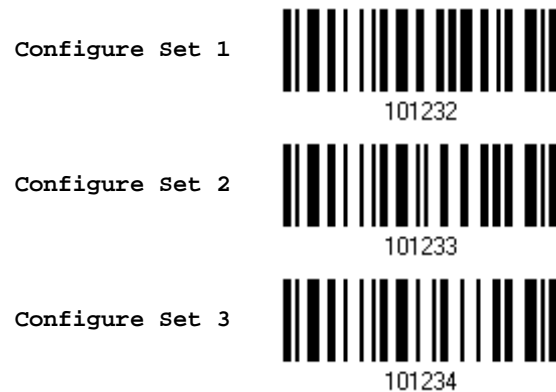

- 1) Read the barcode above to enable character substitution by set.

For example, have the scanner read the "Set 1" barcode to configure the first set of character substitution. The scanner will respond with one short beep, high tone, to indicate more setup barcodes are required.

- 2) Read the "[Hexadecimal Value](#)" barcode on page 228 for the desired character substitution. For example,

KEY TYPE = NORMAL

- ▶ Read "3", "0", "2", and "D" to replace the character "0" with a dash "-".
- ▶ Read "3", "0", "2", "D", "3", and "0" to replace the character "0" with a dash "-0".

KEY TYPE = SCAN CODE

If you want to replace the character "0" with "a" (= "1C" on the scan code table):

1. Read "3" and "0".
2. Read the "Scan Code" barcode.
3. Read "1" and "C".

KEY TYPE = NORMAL + KEY STATUS = SHIFT

If you want to replace the character "0" with "!" (= "Shift" + "1" on keyboard):

1. Read "3" and "0".
2. Read the "Add Shift" barcode.
3. Read "3" and "1".

- 3) Read the "Validate" barcode to complete this setting. (The defined set or sets will be applied to all symbologies by default.)



5.2.2 SYMBOLOGIES FOR CHARACTER SUBSTITUTION (ALL 3 SETS)

By default character substitution will be performed on all symbologies. If the character substitution is not desired with one or more symbologies, read the “Do Not Apply” barcode for each undesired symbologies and all the three sets will be ignored for them.

Character Substitution for Codabar

*Apply



101253

Do Not Apply



101252

Character Substitution for Code 39

*Apply



101241

Do Not Apply



101240

Character Substitution for Code 93

*Apply



101255

Do Not Apply



101254

Character Substitution for Code 128

*Apply



101257

Do Not Apply



101256



Character Substitution for GS1-128

*Apply	 101259
Do Not Apply	 101258

Character Substitution for ISBT 128

*Apply	 101293
Do Not Apply	 101292

Character Substitution for EAN-8 (No Addon)

*Apply	 101267
Do Not Apply	 101266

Character Substitution for EAN-8 Addon 2

*Apply	 101269
Do Not Apply	 101268

Character Substitution for EAN-8 Addon 5

*Apply	 101271
Do Not Apply	 101270



Character Substitution for EAN-13 (No Addon)

*Apply	 101273
Do Not Apply	 101272

Character Substitution for EAN-13 Addon 2

*Apply	 101275
Do Not Apply	 101274

Character Substitution for EAN-13 Addon 5

*Apply	 101277
Do Not Apply	 101276

Character Substitution for French Pharmacode

*Apply	 101245
Do Not Apply	 101244

Character Substitution for Italian Pharmacode

*Apply	 101243
Do Not Apply	 101242



Character Substitution for Industrial 25

*Apply	 101247
Do Not Apply	 101246

Character Substitution for Interleaved 25

*Apply	 101249
Do Not Apply	 101248

Character Substitution for Matrix 25

*Apply	 101251
Do Not Apply	 101250

Character Substitution for MSI

*Apply	 101285
Do Not Apply	 101284

Character Substitution for Plessey

*Apply	 101287
Do Not Apply	 101286



Character Substitution for GS1 DataBar

*Apply	 101291
Do Not Apply	 101290

Character Substitution for Telepen

*Apply	 101289
Do Not Apply	 101288

Character Substitution for UPC-A (No Addon)

*Apply	 101279
Do Not Apply	 101278

Character Substitution for UPC-A Addon 2

*Apply	 101281
Do Not Apply	 101280

Character Substitution for UPC-A Addon 5

*Apply	 101283
Do Not Apply	 101282



Character Substitution for UPC-E (No Addon)

*Apply	 101261
Do Not Apply	 101260

Character Substitution for UPC-E Addon 2

*Apply	 101263
Do Not Apply	 101262

Character Substitution for UPC-E Addon 5

*Apply	 101265
Do Not Apply	 101264



5.3 PREFIX/SUFFIX CODE

By default, there is no prefix code, and [ENTER] or [CR] (Carriage Return) is configured to be suffix code. Up to 8 characters can be configured, for example, "Barcode_", and you will have the string appear in front of the barcode read, like this – "Barcode_1234567890".

- ▶ If "BT HID" or "USB HID" is configured for interface, [Key Type](#) and [Key Status](#) will then become applicable. You may decide whether or not to apply Key Status when "Normal Key" is selected for Key Type.

Key Type		Key Status
Scan Code	Up to 4 scan code values are allowed.	N/A
Normal Key	Up to 8 character strings are allowed.	<ul style="list-style-type: none"> ▶ Add Shift ▶ Add Left Ctrl ▶ Add Left Alt ▶ Add Right Ctrl ▶ Add Right Alt Refer to Keyboard Wedge Table .

Configure Prefix



101230

Configure Suffix



101231

- 1) Read the barcode above to apply prefix code or suffix code separately, and follow steps 2~3. (Max. 8 characters each)
- 2) Read the "[Hexadecimal Value](#)" barcode on page 228 for the desired character string. For example, read "2" and "B" for the scanner to prefix or suffix the character [+].
- 3) Read the "Validate" barcode to complete this setting.



5.4 CODE ID

Up to two characters for Code ID can be configured for each symbology. To make the Code ID configuration easier, the scanner provides five pre-defined Code ID sets that you can select one and make necessary changes on it.

- ▶ If "BT HID" or "USB HID" is configured for interface, [Key Type](#) and [Key Status](#) will then become applicable. You may decide whether or not to apply Key Status when "Normal Key" is selected for Key Type.

Key Type		Key Status
Scan Code	Only 1 scan code value is allowed.	N/A
Normal Key	Up to 2 character strings are allowed.	<ul style="list-style-type: none"> ▶ Add Shift ▶ Add Left Ctrl ▶ Add Left Alt ▶ Add Right Ctrl ▶ Add Right Alt Refer to Keyboard Wedge Table .

Note: "]C1" is the Code ID of GS1-128 (EAN-128) barcodes; "]e0" is the default Code ID of GS1 DataBar (RSS) barcodes.

5.4.1 SELECT PRE-DEFINED CODE ID

Apply Code ID Set 1



Apply Code ID Set 2



Apply Code ID Set 3



Apply Code ID Set 4



Apply Code ID Set 5



Code ID options	Set 1	Set 2	Set 3	Set 4	Set 5
Code 39	A	C	Y	M	A
Italian Pharmacode	A	C	Y	M	A
French Pharmacode	A	C	Y	M	A
Industrial 25	C	H	H	H	S
Interleaved 25	D	I	Z	I	S
Matrix 25	E	G	G	G	S
Codabar	F	N	X	N	F
Code 93	I	L	L	L	G
Code 128	H	K	K	K	C
ISBT 128	H	K	K	K	C
UPC-E	S	E	C	E	E
EAN-8	P	B	B	FF	E
EAN-13	M	A	A	F	E
UPC-A	J	A	A	A	E
MSI	V	V	D	P	M
Plessey	W	W	E	Q	P
Telepen	Z	---	---	---	---



5.4.2 CHANGE CODE ID

- 1) Read the barcode below to change code ID of a specific symbology.
- 2) Read the "[Hexadecimal Value](#)" barcode on page 228 for the desired character string. For example, read "4" and "4" for applying the character [D] for Code ID.
- 3) Read the "Validate" barcode to complete this setting.

Configure Code ID for Codabar	
	101456
Configure Code ID for Code 39	
	101450
Configure Code ID for Code 93	
	101457
Configure Code ID for Code 128	
	101458
Configure Code ID for ISBT 128	
	101466
Configure Code ID for EAN-8	
	101460
Configure Code ID for EAN-13	
	101461
Configure Code ID for French Pharmacode	
	101452
Configure Code ID for Italian Pharmacode	
	101451
Configure Code ID for Industrial 25	
	101453



Configure Code ID for
Interleaved 25



101454

Configure Code ID for
Matrix 25



101455

Configure Code ID for
MSI



101463

Configure Code ID for
Plessey



101464

Configure Code ID for
Telepen



101465

Configure Code ID for
UPC-A



101462

Configure Code ID for
UPC-E



101459

5.4.3 CLEAR CODE ID SETTINGS

Clear All Code ID
Settings



109960



5.5 LENGTH CODE

A two-digit code representing the length of barcode data (character count) can be inserted in front of data being transmitted. Such "Length" code can be individually enabled or disabled for each symbology.

Length Code for Codabar

Apply



101413

*Do Not Apply



101412

Length Code for Code 39

Apply



101401

*Do Not Apply



101400

Length Code for Code 93

Apply



101415

*Do Not Apply



101414

Length Code for Code 128

Apply



101417

*Do Not Apply



101416



Length Code for GS1-128 & GS1 DataBar

Apply



101419

*Do Not Apply



101418

Length Code for ISBT 128

Apply



101435

*Do Not Apply



101434

Length Code for EAN-8

Apply



101423

*Do Not Apply



101422

Length Code for EAN-13

Apply



101425

*Do Not Apply



101424

Length Code for French Pharmacode

Apply



101405

*Do Not Apply



101404



Length Code for Italian Pharmacode

Apply	
	101403
*Do Not Apply	
	101402

Length Code for Industrial 25

Apply	
	101407
*Do Not Apply	
	101406

Length Code for Interleaved 25

Apply	
	101409
*Do Not Apply	
	101408

Length Code for Matrix 25

Apply	
	101411
*Do Not Apply	
	101410

Length Code for MSI

Apply	
	101429
*Do Not Apply	
	101428



Length Code for Plessey

Apply



101431

*Do Not Apply



101430

Length Code for Telepen

Apply



101433

*Do Not Apply



101432

Length Code for UPC-A

Apply



101427

*Do Not Apply



101426

Length Code for UPC-E

Apply



101421

*Do Not Apply



101420



5.6 MULTI-BARCODE EDITOR

The Multi-Barcode Editor allows you to decide the output sequence of a concatenation of barcodes. Up to five barcodes can be specified. Enabling this function will force the scanner to apply Laser mode as the scan mode.

Note: The Multi-Barcode Editor has nothing to do with [Multi-Barcode Mode](#).

The barcodes that are found meeting the specified criteria below will be arranged in the desired sequence.

- ▶ Code Type
- ▶ 4-digit barcode length, excluding prefix, suffix, length code, etc.
- ▶ Matching the first character of barcode data

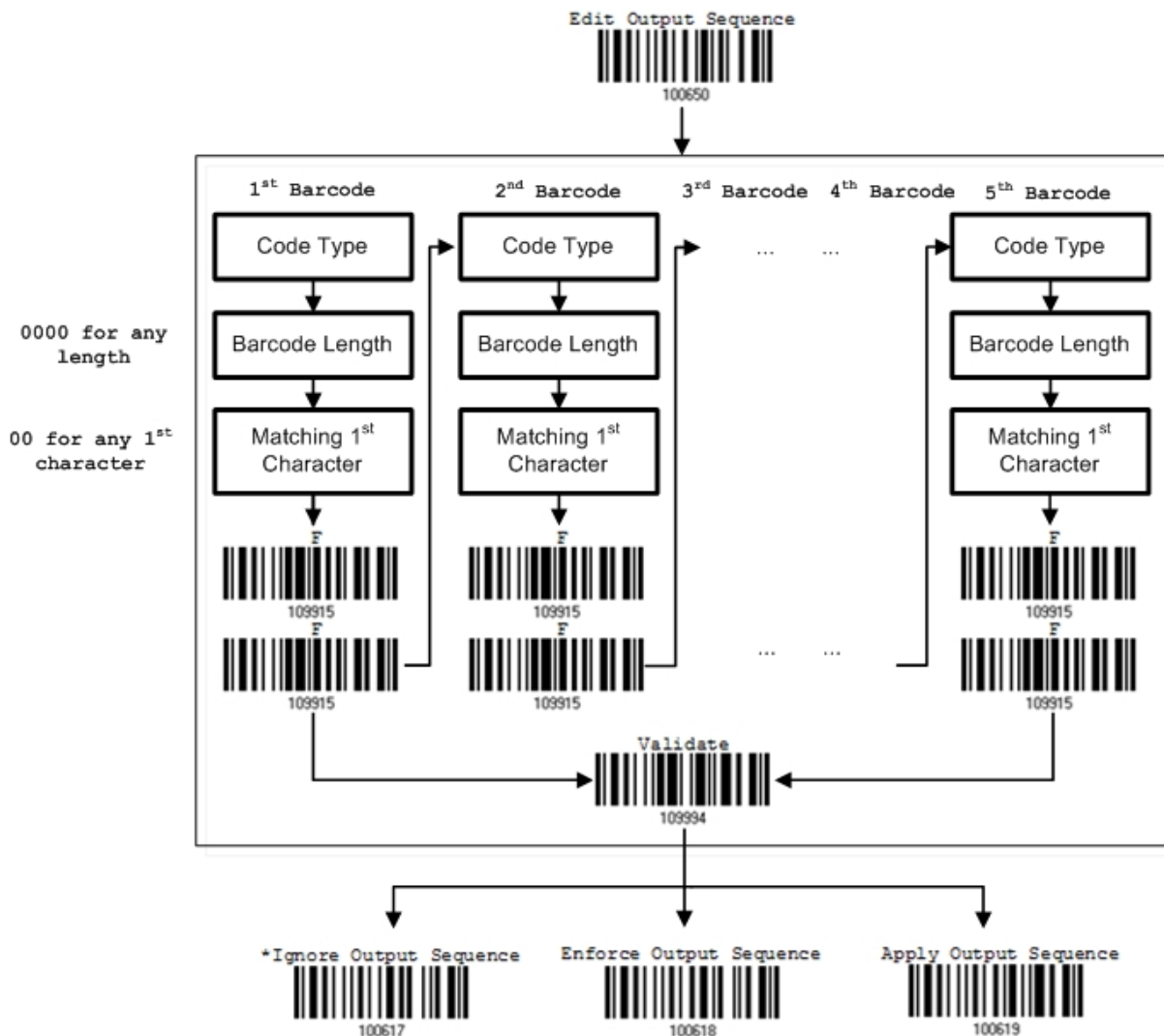

5.6.1 EDIT A CONCATENATION OF BARCODES

Edit Output Sequence



- 1) Read the barcode above to start editing a concatenation of barcodes.
- 2) Code Type setting – read the [“Hexadecimal Value”](#) barcode on page 228 for Code Type of the (first) barcode. For example, read “4” and “1” for Code 39.

Code Type	Symbology	Code Type	Symbology
40 (@)	ISBT 128	4F (O)	EAN-8 with Addon 5
41 (A)	Code 39	50 (P)	EAN-13
42 (B)	Italian Pharmacode	51 (Q)	EAN-13 with Addon 2
43 (C)	French Pharmacode	52 (R)	EAN-13 with Addon 5
44 (D)	Industrial 25	53 (S)	MSI
45 (E)	Interleaved 25	54 (T)	Plessey
46 (F)	Matrix 25	55 (U)	GS1-128 (EAN-128)
47 (G)	Codabar (NW7)	56 (V)	UPC-A
48 (H)	Code 93	57 (W)	UPC-A with Addon 2
49 (I)	Code 128	58 (X)	UPC-A with Addon 5
4A (J)	UPC-E0 / UPC-E1		
4B (K)	UPC-E with Addon 2	5A (Z)	Telepen
4C (L)	UPC-E with Addon 5	5B ([])	GS1 DataBar (RSS)
4D (M)	EAN-8		
4E (N)	EAN-8 with Addon 2		

- 3) Barcode Length setting – read the [“Decimal Value”](#) barcode on page 227 for the 4-digit length of the (first) barcode. For example, read “0065” for barcode length of 65 characters or read “0000” for any length.

Note: If not reading 0000 for any length, the 4-digit length must exclude prefix, suffix (0x0d by default), length code, etc.

- 4) Matching Character setting – read the [“Hexadecimal Value”](#) barcode on page 228 for the 1st character that must be found matching in the (first) barcode. For example, read “4” and “1” for matching character “A” as the first character in the barcode or read “00” for any character.
- 5) Read twice the “F” barcode on page 228 (“FF”) to complete the setting of each barcode.
- 6) Read the “Validate” barcode to end the editing of the barcode set.



5.6.2 ACTIVATE THE CONCATENATION OF BARCODES

By default, the output sequence editing of the concatenation of barcodes is not applied.

When “Enforce Output Sequence” is enabled, all barcodes read by the scanner must meet with the criteria for the concatenation. If data is found excluded from all output sequence sets (= not meeting with the criteria), the scanner will not accept the reading, and therefore, data will not be transmitted.

When “Apply Output Sequence” is enabled, only barcodes found meeting with the criteria are counted for the concatenation. Those found not meeting with the criteria are processed normally and individually.

Note: When it requires reading more barcodes to complete the “output sequence” requirements, the scanner will respond with one short beep (low tone). After reading an acceptable barcode, its LED indicator will become solid green and go off quickly (= Good Read).

Upon completion of reading acceptable barcodes, the scanner will respond with one short beep (high tone) and its LED indicator will become solid green and go off quickly (= Good Read).



Warning: When you disable the Multi-Barcode Editor later, the scan mode remains unchanged. If Laser mode is not desired, proceed to select a scan mode best suits your application.



5.7 REMOVAL OF SPECIAL CHARACTER

You can only specify 1 character, but it will remove every matching character encountered from the starting position of barcode data until a different character is met. For example, if it is configured to remove the character "0" (hex value is "30"), one or more zeros will be stripped off the barcode data "012345" and "00012345". However, for barcode data "010333", only the first zero will be stripped off.

Remove Special
Character



101470

- 1) Read the barcode above to remove the specified character.
- 2) Read the ["Hexadecimal Value"](#) barcode on page 228 for the desired character string. For example, read "3" and "0" for the scanner to remove the character "0".
- 3) Read the "Validate" barcode to complete this setting.



APPLYING FORMATS FOR DATA EDITING

The scanner allows advanced data editing by applying user-configured editing formats. The whole processed data can be divided into fields by user-specified rules. These fields together with the user-configurable additional fields consist of the data actually sent to the host computer.

[PrefixCode]	[Code ID]	[LengthCode]	[Data]	[SuffixCode]	Additional Field(s)
None by default	None by default	None by default	Barcode itself	0x0d by default	

IN THIS CHAPTER

6.1 Activating Editing Formats	178
6.2 Editing Format	180
6.3 Configuring Format — Define Data Criteria	183
6.4 Configuring Format — Define Data Field.....	192
6.5 Configuring Format — Define Transmission Sequence....	201
6.6 Programming Examples	203



6.1 ACTIVATING EDITING FORMATS

6.1.1 ACTIVATE EDITING FORMATS

If you have already configured any editing format before, you may directly apply the editing format. If not, you must start with configuring an editing format first, and then, activate the editing format when it is desired in use.

Editing Format 1

Enable



*Disable



Editing Format 2

Enable



*Disable



Editing Format 3

Enable



*Disable



Editing Format 4

Enable



*Disable



Editing Format 5



6.1.2 EXCLUSIVE DATA EDITING

By default, only barcodes found meeting with the criteria are processed by the editing formats. Those found not meeting with the criteria are processed normally.

When "Exclusive Data Editing" is enabled, all barcodes read by the scanner must be processed by the editing formats. If data is found excluded from all enabled editing formats (= not meeting with the specified criteria), the scanner will not accept the reading, and therefore, data will not be transmitted.



6.2 EDITING FORMAT

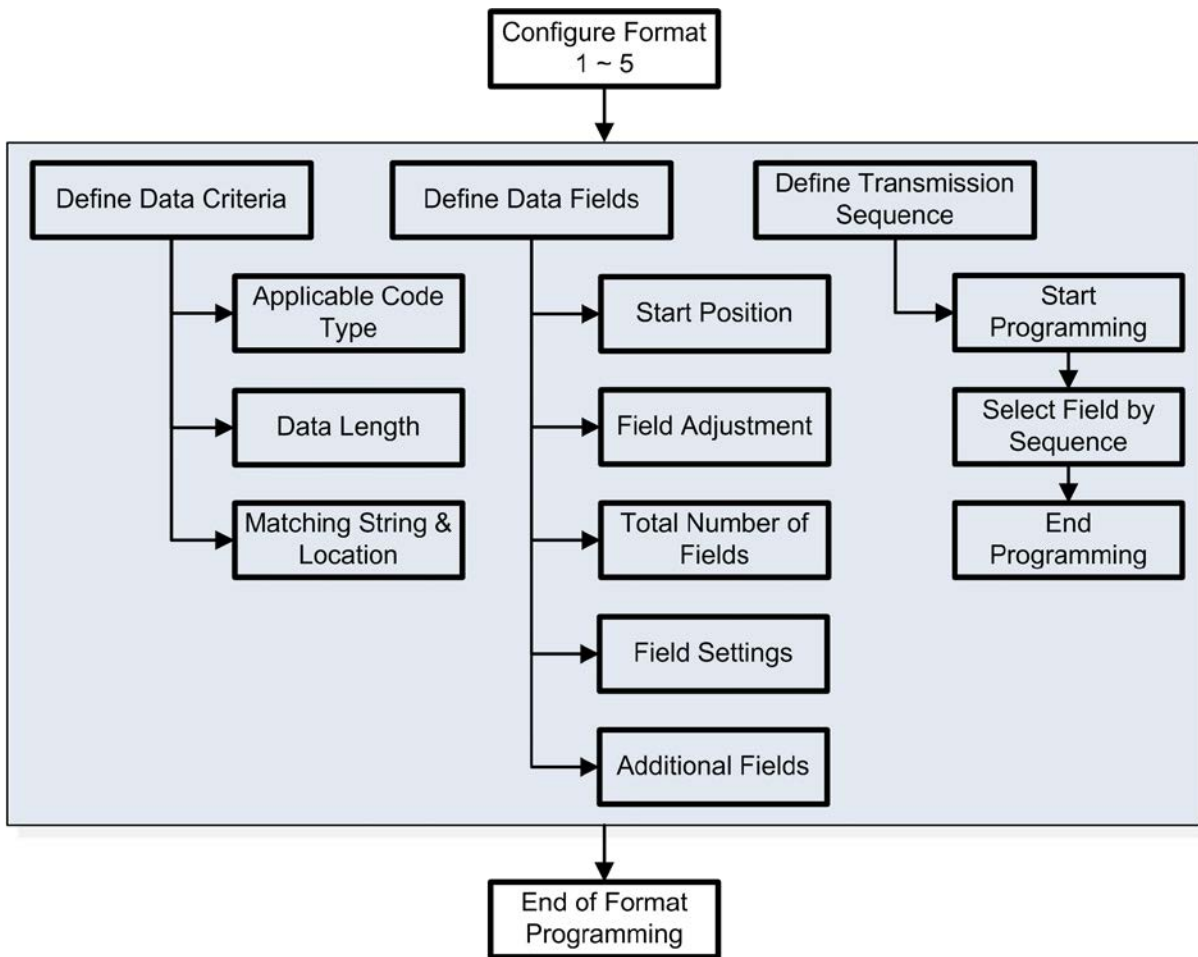

6.2.1 SELECT FORMAT TO CONFIGURE

Start Programming Format

Select one editing format (Format 1~5) and the parameters pertaining to the editing format can then be configured – applicable code type, data length, matching string & location, start position, field adjustment, total number of fields, field settings (field-dividing rule), additional fields, and field transmission sequence.

- ▶ Up to five different formats can be specified.

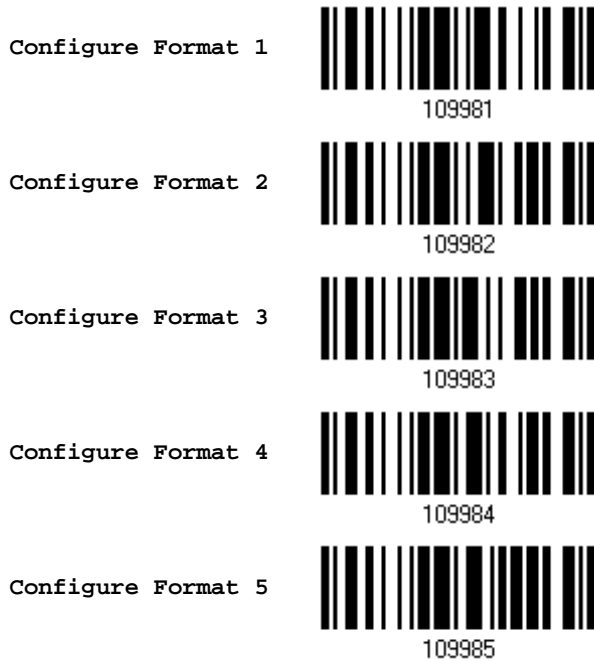

Note: Before you complete the programming of an editing format, if you have the scanner read any barcode for parameters other than those pertaining to the editing format, it will automatically abort the programming process.

End Programming Format

After having configured all the desired parameters, you must have the scanner read the “End Programming Format” barcode, which can be located at the bottom of every even page in this chapter.



6.2.2 RESTORE DEFAULT FORMAT

You may select an existing editing format and have the defaults restored. The default settings of an editing format are listed below.

Editing format	Defaults
Applicable Code Type	All
Data Length	0 (No qualification)
Matching String	Disable
Matching String Location	None
Start Position	From head
Field Adjustment	No adjustment
Total Number of Fields	1
Field Setting – field-dividing rule	Not configured
Additional Fields	None
Field Transmission Sequence	F1

Restore Default
Format



109990



6.3 CONFIGURING FORMAT — DEFINE DATA CRITERIA

Three applicable conditions can be configured to check whether the data read by the scanner can be processed by the particular editing format.

Note: Data editing cannot be performed unless the three conditions are all met.

6.3.1 APPLICABLE CODE TYPE

By default, barcodes of all the supported symbologies will be processed by any editing format, if having been configured and enabled. For quick configuration, you may first clear all, and then select the desired symbologies.

Note: You must have at least one symbology selected.

*Apply to All



Clear All



Editing Format for Codabar

*Apply	 101513
Do Not Apply	 101512

Editing Format for Code 39

*Apply	 101501
Do Not Apply	 101500

Editing Format for Code 93

*Apply	 101515
Do Not Apply	 101514

Editing Format for Code 128

*Apply	 101517
Do Not Apply	 101516

Editing Format for GS1-128 & GS1 DataBar

*Apply	 101519
Do Not Apply	 101518



Editing Format for ISBT 128

*Apply	 101553
Do Not Apply	 101552



Editing Format for EAN-8

*Apply	 101527
Do Not Apply	 101526

Editing Format for EAN-8 Addon 2

*Apply	 101529
Do Not Apply	 101528

Editing Format for EAN-8 Addon 5



*Apply	 101531
Do Not Apply	 101530

Editing Format for EAN-13

*Apply	 101533
Do Not Apply	 101532



Editing Format for EAN-13 Addon 2

*Apply	 101535
Do Not Apply	 101534

Editing Format for EAN-13 Addon 5

*Apply	 101537
Do Not Apply	 101536



Editing Format for French Pharmacode

*Apply	 101505
Do Not Apply	 101504

Editing Format for Italian Pharmacode

*Apply	 101503
Do Not Apply	 101502

Editing Format for Industrial 25

*Apply	 101507
Do Not Apply	 101506



Editing Format for Interleaved 25

*Apply



101509

Do Not Apply



101508

Editing Format for Matrix 25

*Apply



101511

Do Not Apply



101510

Editing Format for MSI

*Apply



101545

Do Not Apply



101544

Editing Format for Plessey

*Apply



101547

Do Not Apply



101546

Editing Format for Telepen

*Apply



101549



Do Not Apply



101548



Editing Format for UPC-A

*Apply	 101539
Do Not Apply	 101538

Editing Format for UPC-A Addon 2

*Apply	 101541
Do Not Apply	 101540

Editing Format for UPC-A Addon 5

*Apply	 101543
Do Not Apply	 101542

Editing Format for UPC-E

*Apply	 101521
Do Not Apply	 101520

Editing Format for UPC-E Addon 2

*Apply	 101523
Do Not Apply	 101522



Editing Format for UPC-E Addon 5

*Apply



101525

Do Not Apply



101524



Update

6.3.2 DATA LENGTH

The length must include prefix, suffix (0x0d by default), length code, etc. By default, barcodes of any length (character count) are eligible for data editing.

- ▶ You may specify a value from 0 to 254.
- ▶ When zero is given to both, the scanner will not perform the length qualification.

1) Read the barcode below to specify Max. Length or Min. Length separately, and follow steps 2~3.



- 2) Read the "[Decimal Value](#)" barcode on page 227 for the desired length.
- 3) Read the "Validate" barcode on the same page to complete this setting.



6.3.3 MATCHING STRING & LOCATION

By default, no matching string is specified, and therefore, it is disabled. You may enable this feature by specifying a matching string; up to four characters are allowed.

- ▶ When the Matching String Location is zero, the scanner will only check for the existence of the matching string in the barcode data.
- ▶ You may specify a value from 1 to 254 to indicate where the matching string starts in the barcode data.

1) Read the barcode to specify a matching string.

Matching String...



- 2) Read the "[Hexadecimal Value](#)" barcode on page 228 for the desired character string.
- 3) Read the "Validate" barcode to complete this setting.
- 4) Read the barcode to specify the location of the matching string.

Location of Matching
String...



- 5) Read the "[Decimal Value](#)" barcode on page 227 for the desired location.
- 6) Read the "Validate" barcode on the same page to complete this setting.



6.4 CONFIGURING FORMAT – DEFINE DATA FIELD

6.4.1 START POSITION

Data can be divided into fields in one of the following direction –

- ▶ from head (F1) to tail (F5)
- ▶ from tail (F1) to head (F5)

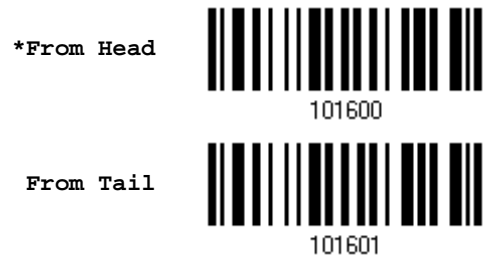

6.4.2 FIELD ADJUSTMENT

You may apply equal length to all fields, if necessary. If data is found longer than specified, it will be truncated automatically. When data is found shorter, it will add "Space" (0x20) to field.

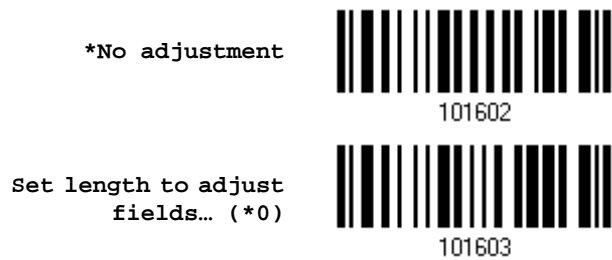

- 1) Read the barcode above to adjust field by length.
- 2) Read the "[Decimal Value](#)" barcode on page 227 for the desired field length.
- 3) Read the "Validate" barcode on the same page to complete this setting.



6.4.3 TOTAL NUMBER OF FIELDS

Data can be divided into at most 6 fields; each of them is numbered from F1 to F6 accordingly. However, only F1~F5 can be configured.

- ▶ The total number of fields must be specified correctly. If three fields are configured for the editing format, the data characters after F3 will be assigned to F4 automatically. This feature is quite useful especially when data of variable lengths is processed by editing formats.

*One Field	
	101590
Two Fields	
	101591
Three Fields	
	101592
Four Fields	
	101593
Five Fields	
	101594
Six Fields	
	101595

Note: The number of configurable fields is always one less than the total number of fields specified. The extra data characters beyond the last field configured will be automatically assigned to the next field.



6.4.4 FIELD SETTINGS

Data eligible for editing formats is divided into fields by user-specified rules – either using the field terminating string or specified field length.

By Terminating String

Specify the field terminating string. Up to two characters are allowed. The scanner will search for the occurrence of this particular string in the data.

- ▶ By default, this string will be included in the field. You may discard it.

By Length

Alternatively, you may simply specify the field length. The scanner will assign the next specified number of characters into the field.

Field 1 Setting

1. Read the barcode below to divide field 1 by a specified terminating string.

Select
Field Separator
to Divide Field 1...



2. Read the ["Hexadecimal Value"](#) barcode on page 228 for the desired character string.
3. Read the "Validate" barcode to complete this setting.
4. Read the "Discard Separator" barcode if the field separator is not desired in the field.

*Include Separator



Discard Separator



If not dividing the field by a specific separator, you may divide it by a specified length.

1. Read the barcode below to divide field 1 by length.

Divide Field 1
by Length



2. Read the ["Decimal Value"](#) barcode on page 227 for the desired field length.
3. Read the "Validate" barcode on the same page to complete this setting.



Field 2 Setting

1. Read the barcode below to divide field 2 by a specified terminating string.

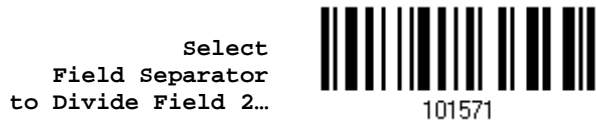

2. Read the "[Hexadecimal Value](#)" barcode on page 228 for the desired character string.
3. Read the "Validate" barcode to complete this setting.
4. Read the "Discard Separator" barcode if the field separator is not desired in the field.



If not dividing the field by a specific separator, you may divide it by a specified length.

1. Read the barcode below to divide field 2 by length.

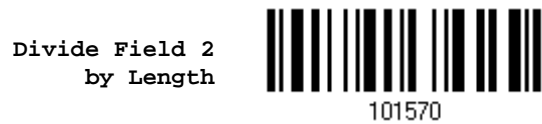

2. Read the "[Decimal Value](#)" barcode on page 227 for the desired field length.
3. Read the "Validate" barcode on the same page to complete this setting.



Field 3 Setting

1. Read the barcode below to divide field 3 by a specified terminating string.

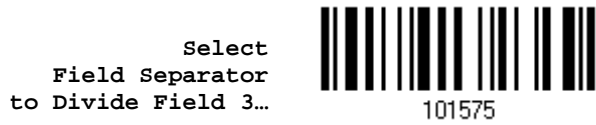

2. Read the "[Hexadecimal Value](#)" barcode on page 228 for the desired character string.
3. Read the "Validate" barcode to complete this setting.
4. Read the "Discard Separator" barcode if the field separator is not desired in the field.



If not dividing the field by a specific separator, you may divide it by a specified length.

1. Read the barcode below to divide field 3 by length.



2. Read the "[Decimal Value](#)" barcode on page 227 for the desired field length.
3. Read the "Validate" barcode on the same page to complete this setting.



Field 4 Setting

1. Read the barcode below to divide field 4 by a specified terminating string.

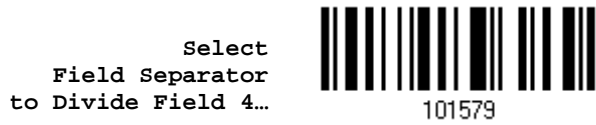

2. Read the "[Hexadecimal Value](#)" barcode on page 228 for the desired character string.
3. Read the "Validate" barcode to complete this setting.
4. Read the "Discard Separator" barcode if the field separator is not desired in the field.



If not dividing the field by a specific separator, you may divide it by a specified length.

1. Read the barcode below to divide field 4 by length.



2. Read the "[Decimal Value](#)" barcode on page 227 for the desired field length.
3. Read the "Validate" barcode on the same page to complete this setting.



Field 5 Setting

1. Read the barcode below to divide field 5 by a specified terminating string.

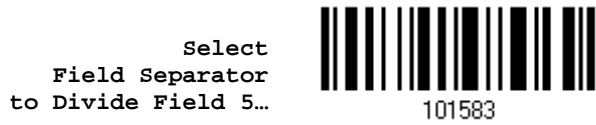

2. Read the "[Hexadecimal Value](#)" barcode on page 228 for the desired character string.
3. Read the "Validate" barcode to complete this setting.
4. Read the "Discard Separator" barcode if the field separator is not desired in the field.



If not dividing the field by a specific separator, you may divide it by a specified length.

1. Read the barcode below to divide field 5 by length.



2. Read the "[Decimal Value](#)" barcode on page 227 for the desired field length.
3. Read the "Validate" barcode on the same page to complete this setting.



Additional Fields

Up to five additional fields can be created for each editing format; each of them is numbered from AF1 to AF5 accordingly.

- ▶ If “BT HID” or “USB HID” is configured for interface, Key Type and Key Status will then become applicable. You may decide whether or not to apply Key Status when “Normal Key” is selected for Key Type.

Key Type		Key Status
Scan Code	Up to 2 scan code values are allowed.	N/A
Normal Key	Up to 4 character strings are allowed.	<ul style="list-style-type: none"> ▶ Add Shift ▶ Add Left Ctrl ▶ Add Left Alt ▶ Add Right Ctrl ▶ Add Right Alt Refer to Keyboard Wedge Table .

1. Read the barcode below to specify an additional field, one at a time.

Additional Field 1...



Additional Field 2...



Additional Field 3...



Additional Field 4...



Additional Field 5...



2. Read the [“Hexadecimal Value”](#) barcode on page 228 for the desired additional field.
3. Read the “Validate” barcode to complete this setting.



6.4.5 PAUSE FIELD SETTING

Pause Field Time

You can limit the pause time interval (1~16). By default, it is set to 1 second.

Pause Field Time
1~16 sec.
(*1)



1. Read the barcode above to specify the time interval for the Pause Field. (It is set to 1 by default.)
2. Read the ["Decimal Value"](#) barcode on page 227. For example, read "1" and "0" for setting the Pause Field Time to 10 seconds.
3. Read the "Validate" barcode on the same page to complete this setting.



6.5 CONFIGURING FORMAT — DEFINE TRANSMISSION SEQUENCE

After configuring the data fields and additional fields, you must now program the transmission sequence of these fields that comprise the final data. This field transmission sequence can be assigned in any desired order and fields can be assigned multiple times as well.

Note: Up to twelve fields can be assigned.

- 1) Read the "Start" barcode to begin with programming the field transmission sequence.

Start Programming...



- 2) Program the transmission sequence by reading the desired fields as well as additional fields.

Field 1



Field 2



Field 3



Field 4



Field 5



Field 6



Additional Field 1



Additional Field 2	 109908
Additional Field 3	 109909
Additional Field 4	 109910
Additional Field 5	 109911
Pause Field	 109912
Null Character Field	 109913

3) Read the "End" barcode to complete this setting.

End Programming...	 109994
--------------------	---



6.6 PROGRAMMING EXAMPLES

6.6.1 EXAMPLE I

Extract data from the 10th character to the 19th character...

The editing format should be configured as follows:

1. Read the "Enter Setup" barcode to enter the Configuration Mode.
2. Read the "Configure Format 1" barcode.
3. Read the "Clear All" and "Code 128" barcodes for applicable code type.
4. Read the "Three Fields" barcode.
5. Read the "Divide Field 1 by Length" barcode, and set length to 9.
Field 1 data starts from the 1st character to the 9th character.
6. Read the "Divide Field 2 by Length" barcode, and set length to 10.
Field 2 data starts from the 10th character to the 19th character.
7. Read the "Start (Programming)" barcode to program the transmission sequence.
8. Read the "Field 2" barcode.
9. Read the "End" barcode to complete the transmission sequence setting.
10. Read the "End Programming Format" barcode to complete the setting of Editing Format 1.
11. Read the "Enable Format 1" barcode to apply Editing Format 1 to Code 128.
12. Read the "Update" barcode to exit the Configuration Mode.



6.6.2 EXAMPLE II

Extract the date code, item number, and quantity information from barcodes.

Data in a barcode is encoded like this:

- ▶ From the 1st character to the 6th character is the date code.
- ▶ From the 7th character to the dash '-' character is the item number.
- ▶ After the dash '-' character is the quantity information.

Data will be transmitted like this:

- ▶ The item number goes first, then a TAB character, followed by the date code, then another TAB character, and finally the quantity information.

The editing format should be configured as follows:

1. Read the "Enter Setup" barcode to enter the Configuration Mode.
2. Read the "Configure Format 2" barcode.
3. Read the "Three Fields" barcode.
4. Read the "Divide Field 1 by Length" barcode, and set length to 6.
Field 1 data starts from the 1st character to the 6th character.
5. Read the "Select Field Separator to Divide Field 2" barcode, and use a dash '-' character.
Field 2 data starts from the 7th character until the dash '-' character is met.
6. Read the "Additional Field 1" barcode, and use a tab character for the field.
7. Read the "Start (Programming)" barcode to program the transmission sequence.
8. Read the "Field 2", "Additional Field 1", "Field 1", "Additional Field 1", "Field 3" barcodes.
9. Read the "End" barcode to complete the transmission sequence (F2 A1 F1 A1 F3) setting.
10. Read the "End Programming Format" barcode to complete the setting of Editing Format 1.
11. Read the "Enable Format 2" barcode to apply Editing Format 2 to all code types.
12. Read the "Update" barcode to exit the Configuration Mode.



SPECIFICATIONS

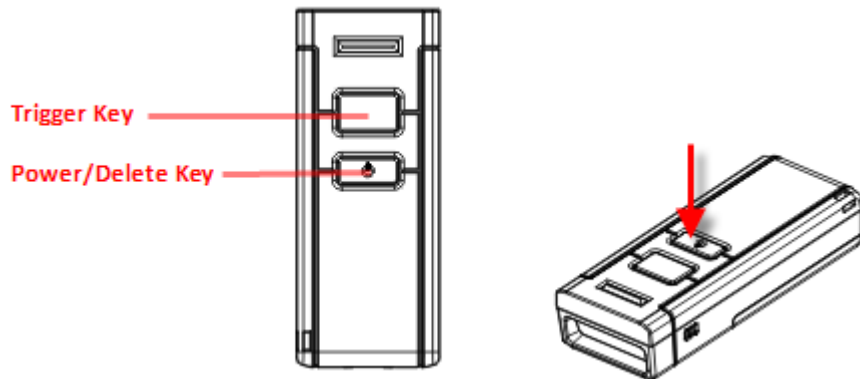

Optical Characteristics	1660	1661
Scan Engine	Non-contact type	
Optical Sensor	CCD, 2500 pixels	
Light Source	Visible red LED	
RF Characteristics		
WPAN Module	Wireless PAN BT Class 3 compliance	
Coverage (line-of-sight)	10 meters with 3610	
Interface Supported	<ul style="list-style-type: none"> ▶ Serial Port Profile (BT SPP) ▶ Human Interface Device Profile (BT HID) ▶ 3610 ▶ Direct USB HID (1661 only) ▶ Direct USB Virtual COM (1661 only) 	
Physical Characteristics		
Memory	<ul style="list-style-type: none"> ▶ 1 KB for transmit buffer ▶ 256 KB flash for memory mode (1660) ▶ 512 KB flash for memory mode (1661) 	
Switch	Push-button switch for [Trigger] key, plus [Power/Delete] key	
Indication	Triple-color LED (Red/Green/Blue) and beeper	
Dimensions	95 mm (L) 35 mm (W) 20 mm (H)	
Weight	Approx. 50 g	Approx. 69 g



Electrical Characteristics		
Battery	2 AAA Alkaline batteries	Rechargeable Li-ion battery — 3.7 V, 850 mAh
Power Adaptor		
Input	---	AC 100~240 V (50/60 Hz)
Output	---	DC 5V 2A (Battery Charger)
Operating Temperature	---	0 °C to 40 °C
Environmental Characteristics		
Temperature	Operating	0 °C to 50 °C
	Storage	-20 °C to 60 °C
Humidity (Non-condensing)	Operating	10% to 90%
	Storage	5% to 95%
Resistance		
Electrostatic Discharge	± 15 kV air discharge, ± 8 kV contact discharge	
Programming Support		
Configuration	Use setup barcodes or host serial commands.	
Software	Windows®-based ScanMaster	
Firmware upgradeable	Download firmware updates via the download utility.	
Accessories (√ means “supported”)		
BT Transponder (3610)	√	√
Rechargeable Li-ion Battery		√
Direct USB Cable		√



FIRMWARE UPGRADE

You can only upgrade firmware of one scanner at a time. For example, you must turn off each of the rest scanners when there is more than one scanner connected to your computer.

Note: 1. Ensure the scanner has a fully charged battery prior to attempting a firmware upgrade.
2. In order to avoid the data loss during firmware upgrade. Please save or upload all the data from the flash memory before beginning firmware upgrade.

HOW TO UPGRADE 1660/1661 FIRMWARE

USING 3610

- 1) Connect 3610 to the USB port of PC. You may need to install its driver first!
- 2) Refer to [3.1.1 Connect to 3610](#) the target scanner to connect to 3610.
Read the "Set Connection" label first, and then the "Serial Number" label. Both labels can be located at the back of 3610.
- 3) Read the following barcodes in sequence to configure the scanner to use USB Virtual COM as download interface.

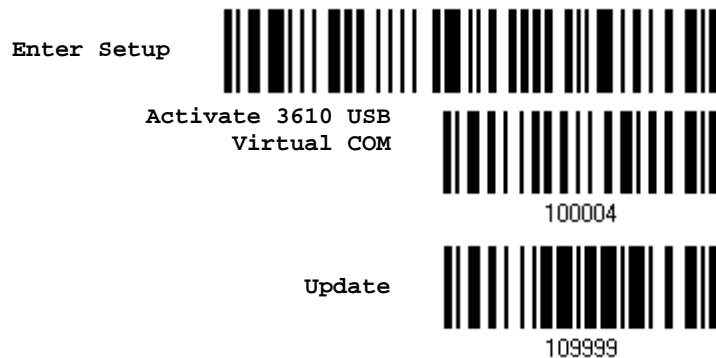

Note: For 1661, you may choose to use "Direct" USB Virtual COM interface.

- 4) Read the following barcodes in sequence for the scanner to enter the download mode. The scanner will respond with beeps to indicate it is ready for downloading.





5) Run the download utility "ProgLoad.exe" on your computer.

Kernel Program	User Program
K1660_V*.shx	STD1660_V*.shx
K1661_V*.shx	STD1661_V*.shx

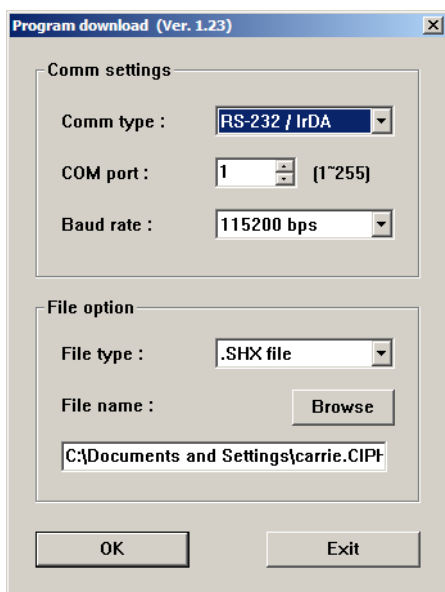

- ▶ For the communication settings, select "RS-232" and the correct COM port for USB Virtual COM interface.
- ▶ Ignore the baud rate setting.
- ▶ For the file option, click [Browse] to select the target file for firmware update.
- ▶ Click [OK].

6) After upgrading kernel, you will need to manually restart the scanner.

After upgrading the user program, the scanner will automatically restart itself once the download is completed successfully.

Note: The output interface remains unchanged as specified in step 3 (= USB Virtual COM).



USING DIRECT USB VIRTUAL COM (1661 ONLY)

- 1) Use the provided USB cable to connect 1661 to the USB port of PC. You may need to install its driver first!
- 2) Read the following barcodes in sequence to configure 1661 to use Direct USB Virtual COM as download interface and enter the download mode. The scanner will respond with beeps to indicate it is ready for downloading.



- 3) Run the download utility "ProgLoad.exe" on your computer.

Kernel Program	User Program
K1661_V*.shx	STD1661_V*.shx

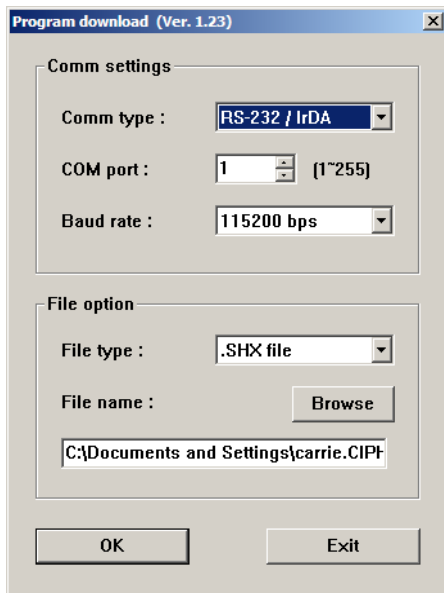

- ▶ For the communication settings, select "RS-232" and the correct COM port for Direct USB Virtual COM interface.
- ▶ Ignore the baud rate setting.
- ▶ For the file option, click [Browse] to select the target file for firmware update.
- ▶ Click [OK].

- 4) After upgrading kernel, you will need to manually restart the scanner.

After upgrading the user program, the scanner will automatically restart itself once the download is completed successfully.

Note: Because Direct USB Virtual COM interface is only provided for 1661 to download firmware, the output interface will be set to the previous one in use upon completion of firmware upgrade.



USING BLUETOOTH® DONGLE

- 1) Refer to [3.2.3 Connect to Dongle](#) for the target scanner to accept the connection request from your computer.
- 2) Read the following barcodes in sequence to configure the scanner to use BT SPP as download interface.

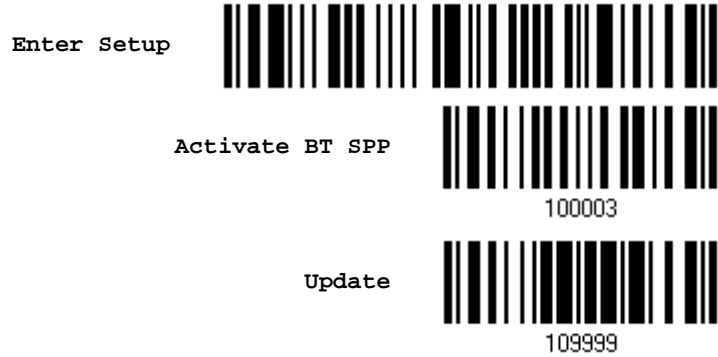

- 3) Read the following barcodes in sequence for the scanner to enter the download mode. The scanner will respond with beeps to indicate it is ready for downloading.



- 4) Run the download utility "ProgLoad.exe" on your computer.

Kernel Program	User Program
K1660_V*.shx	STD1660_V*.shx
K1661_V*.shx	STD1661_V*.shx



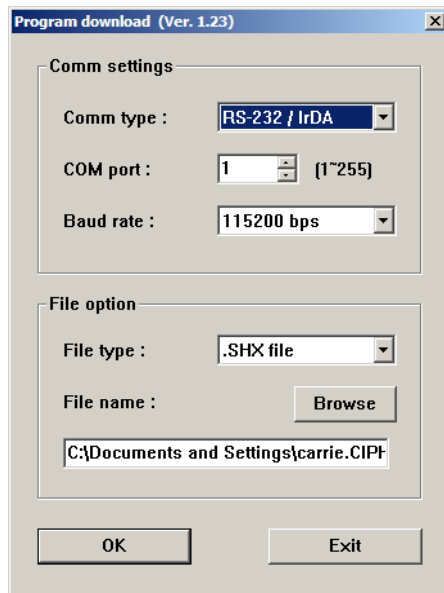

- ▶ For the communication settings, select "RS-232" and the correct COM port for BT SPP interface.
- ▶ Ignore the baud rate setting.
- ▶ For the file option, click [Browse] to select the target file for firmware update.
- ▶ Click [OK].

5) After upgrading kernel, you will need to manually restart the scanner.

After upgrading the user program, the scanner will automatically restart itself once the download is completed successfully.

Note: The output interface remains unchanged as specified in step 2 (= BT SPP).



HOW TO UPGRADE 3610 FIRMWARE

Connect 3610 to the USB port of PC. You may need to install its driver first! Refer to [3.1.1 Connect to 3610](#) for the target scanner to connect to 3610.

Note: While upgrading 3610 firmware, the system will automatically use the VCOM_CDC driver if the current connection interface is HID. Make sure the VCOM_CDC driver has been installed on your computer (for firmware 2.0 or later).

UPGRADING 3610 CPU FIRMWARE

- 1) Read the following barcodes in sequence for 3610 to enter the download mode. The Communication LED on 3610 will be flashing red to indicate it is ready for downloading.



- 2) Run the download utility "ProgLoad.exe" on your computer.

Kernel Program	User Program
K3610_V*.shx	STD3610_V*.shx

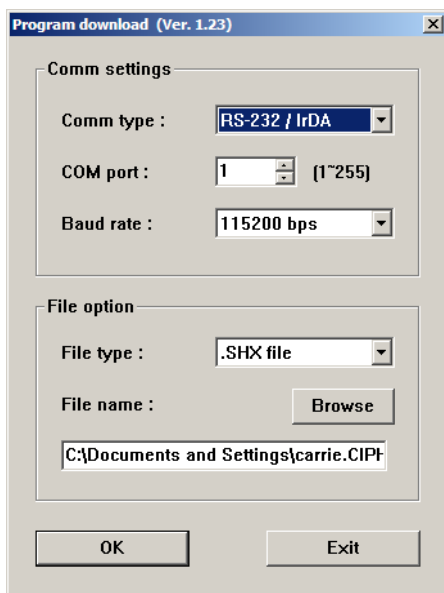

- ▶ For the communication settings, select "RS-232" and the correct COM port for USB Virtual COM interface.
- ▶ Ignore the baud rate setting.
- ▶ For the file option, click [Browse] to select the target file for firmware update.
- ▶ Click [OK].

- 3) The 3610 will automatically restart itself when upgrading firmware is completed successfully.



- 4) Read the “Update” barcode for the scanner to resume its operation (exit the configuration mode).



UPGRADING 3610 USB BRIDGE FIRMWARE

Note: Upgrade USB bridge firmware only for elder firmware versions. There’s no need for 3610 firmware version 2.0 or later to upgrade USB bridge firmware.

- 1) Read the following barcodes in sequence for 3610 to enter the download mode. The Communication LED on 3610 will be flashing red to indicate it is ready for downloading.



- 2) Run the download utility “ProgLoad.exe” on your computer.

Kernel Program	User Program
K3610Bridge_V*.shx	STD3610Bridge_V*.shx

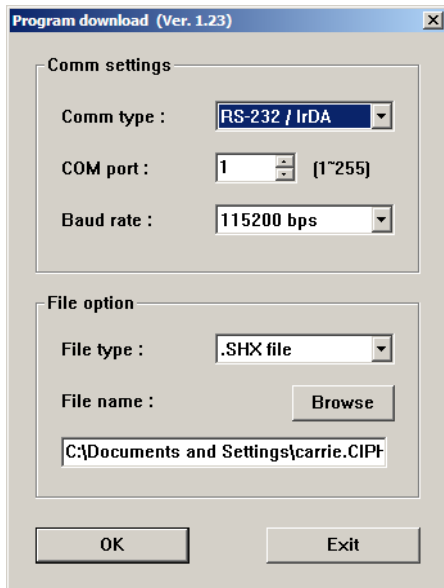

- ▶ For the communication settings, select “RS-232” and the correct COM port for USB Virtual COM interface.
- ▶ Ignore the baud rate setting.
- ▶ For the file option, click [Browse] to select the target file for firmware update.
- ▶ Click [OK].



- 3) The 3610 will automatically restart itself when upgrading firmware is completed successfully.
- 4) Read the "Update" barcode for the scanner to resume its operation (exit the configuration mode).



UPGRADING 1661 USB BRIDGE FIRMWARE

- 1) Connect the USB cable between the scanner and your computer.
 - ▶ If you are using Direct USB Virtual COM for the first time, you must install its driver.
- 2) Read the following barcodes in sequence to configure the scanner to use Direct USB Virtual COM as the download interface.

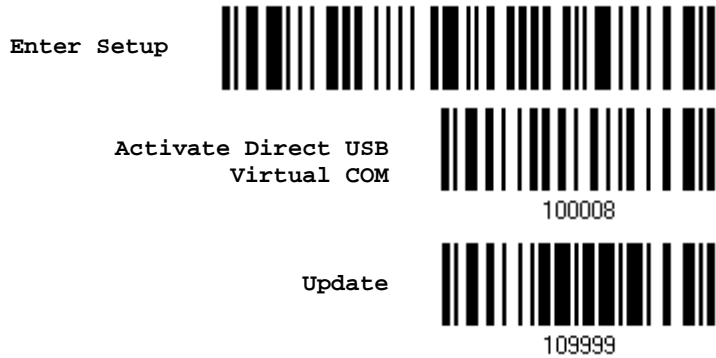

- 3) Read the following barcodes in sequence for the scanner to enter download mode. The scanner will respond with beeps to indicate it is ready for downloading.



- 4) Run the download utility "ProgLoad.exe" on your computer.

Kernel Program	User Program
K1661Bridge_V*.shx	STD1661Bridge_V*.shx



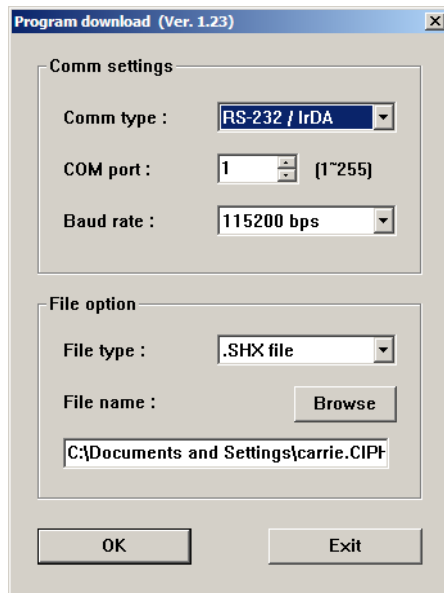

- ▶ For the communication settings, select "RS-232" and the correct COM port for Direct USB Virtual COM interface.
- ▶ Ignore the baud rate setting.
- ▶ For the file option, click [Browse] to select the target file for firmware update.
- ▶ Click [OK].

5) After upgrading kernel, the scanner will automatically restart itself once the download is completed successfully.

Note: The output interface remains unchanged as specified in step 2 (= Direct USB Virtual COM).



HOST SERIAL COMMANDS

1660/1661 SERIAL COMMANDS

D

Purpose To disable the scanner.
 Remarks "D"

E

Purpose To enable the scanner.
 Remarks "E"

#@nnnnnn<CR>

Purpose To configure the scanner.
 Remarks nnnnnn – the six digits of command parameters.
 For example, "109952" is to list the current Code ID settings.

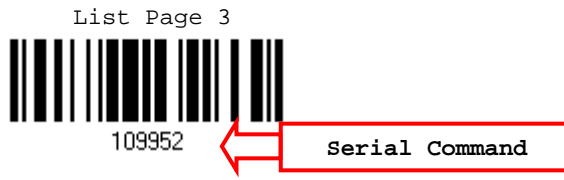

"0x23" + "0x40" + "0x31" + "0x30" + "0x39" + "0x39" + "0x35" + "0x32" + "0x0d"

Note: After configuring the scanner, you may send the serial command "#@109999" to save the settings.

#@----<CR>

Purpose To halt the scanner.
 Remarks "0x23" + "0x40" + "0x2d" + "0x2d" + "0x2d" + "0x2d" + "0x0d"

#@....<CR>

Purpose To resume operation.
 Remarks "0x23" + "0x40" + "0x2e" + "0x2e" + "0x2e" + "0x2e" + "0x0d"

#@////<CR>

Purpose To respond with a beep.
 Remarks "0x23" + "0x40" + "0x2f" + "0x2f" + "0x2f" + "0x2f" + "0x0d"



#@TRIGOFF<CR>

Purpose	Disable the software trigger
Remarks	"0x23" + "0x40" + "0x54" + "0x52" + "0x49" + "0x47" + "0x4f" + "0x46" + "0x46" + "0x0d"

#@TRIGON<CR>

Purpose	Enable the software trigger
Remarks	"0x23" + "0x40" + "0x54" + "0x52" + "0x49" + "0x47" + "0x4f" + "0x4e" + "0x0d"

#@RDSN<CR>

Purpose	Read serial number
Remarks	"0x23" + "0x40" + "0x52" + "0x44" + "0x53" + "0x4E" + "0x0D"

EXAMPLE

You may run HyperTerminal.exe on the host computer to send serial commands to the scanner via BT SPP or USB Virtual COM.

- ▶ For the scanner to stop immediately –
D
- ▶ For the scanner to resume working –
E
- ▶ For the scanner to change the beeper to medium volume and beep –
#@101011<CR>
#@////<CR>
- ▶ For the scanner to change the beeper to minimal volume and beep –
#@101010<CR>
#@////<CR>
- ▶ For the scanner to change the beeper frequency to 8 kHz (for Good Read Beep only) and beep –
#@101001<CR>
#@////<CR>
- ▶ For the scanner to change the beeper length to longest (for Good Read Beep only) and beep –
#@101008<CR>
#@////<CR>
- ▶ For the scanner to save the settings, send the serial command "#@109999" –
#@101011<CR>
#@109999<CR>



- ▶ For the scanner to read the serial number and beep –
 - #@RDSN<CR>
 - #@/////<CR>

Note: (1) For USB Virtual COM, you can only configure the first scanner that connects to 3610. To identify the scanner, you may send the serial command to have it respond with a beep.
 (2) For BT SPP, you can configure up to seven scanners at the same time.

3610 SETUP BARCODES & SERIAL COMMANDS

Normally, you can configure the 3610 dongle by having a connected scanner read 3610-related setup barcodes.

- 1) Connect 3610 to the USB port of PC. You may need to install its driver first!
- 2) Refer to [3.1.1 Connect to 3610](#) for the target scanner to connect to 3610.
 Read the “Set Connection” label first, and then the “Serial Number” label. Both labels can be located at the back of 3610.
- 3) Read the following barcodes in sequence to configure 3610.

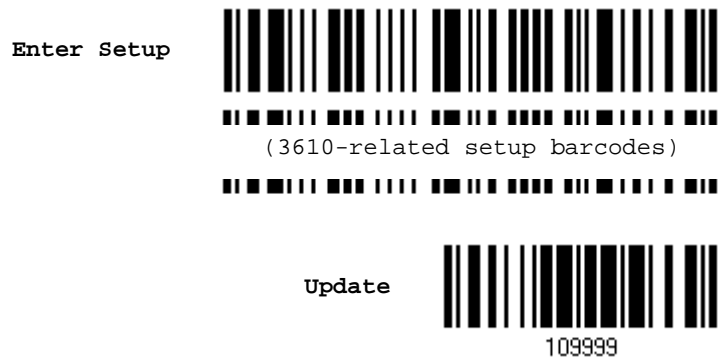

For 3610-related setup barcodes, refer to the Serial Command table below. Note that for the “Version” and “GetID” barcodes, you must run HyperTerminal.exe or any text editor to receive the information.

- ▶ If the output interface is USB Virtual COM, run HyperTerminal.exe on your computer to receive the information.
- ▶ If the output interface is USB HID, run any text editor to receive the information.



3610 SERIAL COMMANDS AND EQUIVALENT SETUP BARCODES

Config<CR>

Purpose To configure 3610.

Here is the setup barcode for this serial command:



Remarks A list of the current settings will be displayed. Run HyperTerminal.exe on your computer and change the settings one by one.

DefaultSetting<CR>

Purpose To restore the default settings.

Here is the setup barcode for this serial command:



SingleConnection<CR>

Purpose To allow only one scanner connecting to 3610.

Here is the setup barcode for this serial command:



MultiConnection<CR>

Purpose To allow up to seven scanners connecting to 3610.

Here is the setup barcode for this serial command:



UseOnePortforAll<CR>

Purpose To use one Virtual COM port for all whenever connecting 3610 to PC via USB. This setting requires you to connect one 3610 at a time, and will facilitate configuring a great amount of 3610 via the same Virtual COM port (for administrators' or factory use).

Here is the setup barcode for this serial command:



UseVariablePort<CR>

Purpose To use variable Virtual COM port when connecting more than one 3610 to PC via USB.

Here is the setup barcode for this serial command:



Version<CR>

Purpose To get the firmware versions (CPU+USB Bridge).

Here is the setup barcode for this serial command:



GetID<CR>

Purpose To get MAC ID.

Here is the setup barcode for this serial command:



Download<CR>

Purpose To download CPU firmware to 3610.

Here is the setup barcode for this serial command:



LoadBridge<CR>

Purpose To download USB Bridge firmware to 3610.

Here is the setup barcode for this serial command:



EXAMPLE

Without using the scanner to read the above setup barcodes for configuring the 3610 dongle, you may run HyperTerminal.exe on the host computer to send serial commands to 3610 via USB Virtual COM.

- 1) Connect 3610 to the USB port of PC.
- 2) The Communication LED will indicate when 3610 can accept serial commands after initializing. Refer to the table below.
 - ▶ If the output interface is USB Virtual COM, run HyperTerminal.exe on your computer. While the Communication LED on 3610 is purple (red with flashing blue), type the serial command within 3 seconds.
 - ▶ If the output interface is USB HID, press the "Num Lock" or "Caps Lock" key via the keyboard 5 times within 3 seconds while the Communication LED on 3610 is flashing red and blue. This will change the interface from USB HID to USB Virtual COM and the Communication LED will become purple (red with flashing blue). Then, run HyperTerminal.exe on your computer. While the Communication LED on 3610 is purple (red with flashing blue), type the serial command within 3 seconds. After configuring via serial commands, the interface will be reset to USB HID after re-connecting 3610.

Communication LED		Meaning
---	Blue, solid	Initialize
Red, solid	Blue, flashing	Serial command mode with USB Virtual COM: wait 3 seconds for starting a serial command
Red, flashing	Blue, flashing	Serial command mode with USB HID changed to USB Virtual COM first: wait 3 seconds for pressing [Num Lock] or [Caps Lock] 5 times via keyboard

The serial commands mentioned above have to be typed within 3 seconds. However, the commands below can be typed freely without any time limit.

#\$ShowScanner<CR>

To list the scanner devices connecting with 3610

#\$SelectScannerN<CR>

To select a scanner device from the list for configuring

N – the scanner ID in numerals representing the scanner device in the list



KEYBOARD WEDGE TABLE

	0	1	2	3	4	5	6	7	8
0		F2	SP	0	@	P	`	p	⓪
1	INS	F3	!	1	A	Q	a	q	①
2	DLT	F4	"	2	B	R	b	r	②
3	Home	F5	#	3	C	S	c	s	③
4	End	F6	\$	4	D	T	d	t	④
5	Up	F7	%	5	E	U	e	u	⑤
6	Down	F8	&	6	F	V	f	v	⑥
7	Left	F9	'	7	G	W	g	w	⑦
8	BS	F10	(8	H	X	h	x	⑧
9	HT	F11)	9	I	Y	i	y	⑨
A	LF	F12	*	:	J	Z	j	z	
B	Right	ESC	+	;	K	[k	{	
C	PgUp	Exec	,	<	L	\	l		
D	CR	CR*	-	=	M]	m	}	
E	PgDn		.	>	N	^	n	~	
F	F1		/	?	O	_	o	Dly	ENTER*

Note: (1) ⓪~⑨: Digits of numeric keypad.
 (2) CR*/ENTER*: ENTER key on the numeric keypad.



KEY TYPE & STATUS

KEY TYPE

If "BT HID" or "USB HID" is configured for interface, Key Type and Key Status will then become applicable.

*Normal



109926

Scan Code



109936

KEY STATUS

Decide whether or not to change key status when "Normal Key" is selected for Key Type.

Add Shift



109930

Add Left Ctrl



109931

Add Right Ctrl



109933

Add Left Alt



109932

Add Right Alt



109934



EXAMPLE**KEY TYPE = NORMAL**

For example, if you want to program the character "!" as the prefix code:

1. Read the "Configure Prefix" barcode.
2. Read the "[Hexadecimal Value](#)" barcode on page 228 for "2" and "1".
3. Read the "Validate" barcode to complete this setting.

KEY TYPE = SCAN CODE

For example, if you want to program the character "a" (= "1C" on the scan code table) as the prefix code:

1. Read the "Configure Prefix" barcode.
2. Read the "Scan Code" barcode.
3. Read the "[Hexadecimal Value](#)" barcode on page 228 for "1" and "C".
4. Read the "Validate" barcode to complete this setting.

KEY TYPE = NORMAL + KEY STATUS = SHIFT

For example, if you want to program the character "!" (= "Shift" + "1" on keyboard) as the prefix code:

1. Read the "Configure Prefix" barcode.
2. Read the "Add Shift" barcode.
3. Read the "[Hexadecimal Value](#)" barcode on page 228 for "3" and "1".
4. Read the "Validate" barcode to complete this setting.

KEY TYPE = NORMAL + KEY STATUS = CTRL

For example, if you want to program "Ctrl+A" and "Ctrl+\$" as the prefix code:

1. Read the "Configure Prefix" barcode.
2. Read the "Add Left Ctrl" barcode.
3. Read the "[Hexadecimal Value](#)" barcode on page 228 for "4", "1" (= "A").
4. Read the "Add Left Ctrl" barcode.
5. Read the "[Hexadecimal Value](#)" barcode on page 228 for "2", "4" (= "\$").
6. Read the "Validate" barcode to complete this setting.





NUMERAL SYSTEMS

DECIMAL SYSTEM

Decimal





Validate the Values



HEXADECIMAL SYSTEM

Hexadecimal

0  109900	1  109901
2  109902	3  109903
4  109904	5  109905
6  109906	7  109907
8  109908	9  109909
A  109910	B  109911
C  109912	D  109913
E  109914	F  109915



Validate the Values



ASCII TABLE

	0	1	2	3	4	5	6	7	
0		DLE	SP	0	@	P	`	p	
1	SOH	DC1	!	1	A	Q	a	q	
2	STX	DC2	"	2	B	R	b	r	
3	ETX	DC3	#	3	C	S	c	s	
4	EOT	DC4	\$	4	D	T	d	t	
5	ENQ	NAK	%	5	E	U	e	u	
6	ACK	SYN	&	6	F	V	f	v	
7	BEL	ETB	'	7	G	W	g	w	
8	BS	CAN	(8	H	X	h	x	
9	HT	EM)	9	I	Y	i	y	
A	LF	SUB	*	:	J	Z	j	z	
B	VT	ESC	+	;	K	[k	{	
C	FF	FS	,	<	L	\	l		
D	CR	GS	-	=	M]	m	}	
E	SO	RS	.	>	N	^	n	~	
F	SI	US	/	?	O	_	o	DEL	

Update



Abort



ENTERING PIN CODE FOR AUTHENTICATION

USE PRESET PIN

- 1) In the configuration mode, read the barcode below to use a preset PIN for authentication.

Use Preset PIN



- 2) Read one of the barcodes to specify the PIN code, in decimal or hexadecimal.
By default, the PIN code is set to "0000". Maximum 16 characters are allowed.

Enter PIN in
Hexadecimal...



Enter PIN in
Decimal...



- 3) Read the "[Decimal Value](#)" barcode on page 227 or the "[Hexadecimal Value](#)" barcode on page 228 for the desired digits or character string.

Read the "Clear PIN Code" barcode first if you need to re-input the PIN code.

Clear PIN Code



- 4) Read the "Validate" barcode to complete this setting.



DISABLE AUTHENTICATION OR USE RANDOM PIN

In the configuration mode, read the barcode below to disable authentication (= No PIN) or use a random PIN for authentication.

*No PIN or
use random PIN



Note: When using BT HID, some device driver may not support pre-defined PIN code for authentication. In this case, make sure you have the scanner set to “No PIN or use random PIN” before pairing. While pairing, the host PIN code will be displayed on the computer screen.

Use Random PIN

When the target device is set to use a random PIN for authentication, wait until the random PIN is displayed on the target device while pairing, and then input the matching PIN code on the scanner.

Note: Follow the steps below to enter the matching PIN on the scanner. There is no need to enter the configuration mode!

1. Read one of the barcodes to specify the PIN code, in decimal or hexadecimal.

Enter PIN in
Hexadecimal...



Enter PIN in
Decimal...



2. Read the [“Decimal Value”](#) barcode on page 227 or the [“Hexadecimal Value”](#) barcode on page 228 for the desired digits or character string.

Read the “Clear PIN Code” barcode first if you need to re-input the PIN.

Clear PIN Code



3. Read the “Validate” barcode to complete this setting.

Reject Random PIN Request

When the random PIN is displayed on the target device while pairing, you can reject the PIN request by having the scanner read the “Validate” barcode.

Update



Abort

