

Gryphon™ | GD/GBT/GM4200

PRODUCT REFERENCE GUIDE



General Purpose Linear Bar Code Reader: Coded or with Bluetooth®
Wireless Technology or Datalogic's STAR Cordless System™

Datalogic S.r.l.

Via S. Vitalino, 13
40012 Calderara di Reno (BO)
Italy
Tel. +39 051 3147011
Fax +39 051 3147205

© 2011-2020 Datalogic S.p.A. and /or its affiliates

All rights reserved. Without limiting the rights under copyright, no part of this documentation may be reproduced, stored in or introduced into a retrieval system, or transmitted in any form or by any means, or for any purpose, without the express written permission of Datalogic S.p.A. and/or its affiliates.

Owners of Datalogic products are hereby granted a non-exclusive, revocable license to reproduce and transmit this documentation for the purchaser's own internal business purposes. Purchaser shall not remove or alter any proprietary notices, including copyright notices, contained in this documentation and shall ensure that all notices appear on any reproductions of the documentation.

Electronic versions of this document may be downloaded from the Datalogic website (www.datalogic.com). If you visit our website and would like to make comments or suggestions about this or other Datalogic publications, please let us know via the "Contact" page.

Disclaimer

Datalogic has taken reasonable measures to provide information in this manual that is complete and accurate, however, Datalogic shall not be liable for technical or editorial errors or omissions contained herein, nor for incidental or consequential damages resulting from the use of this material. Datalogic reserves the right to change any specification at any time without prior notice.

Trademarks

Datalogic and the Datalogic logo are registered trademarks of Datalogic S.p.A. in many countries, including the U.S.A. and the E.U.

Gryphon is a trademark of Datalogic S.p.A. and/or its affiliates, registered in the U.S. The Bluetooth word mark and logos are owned by Bluetooth SIG, Inc. and any use of such marks by Datalogic S.p.A. and/or its affiliates is under license. All other trademarks and brands are property of their respective owners.

Patents

See www.patents.datalogic.com for patent list.

Software Version

This manual refers to the following software versions and later:

GD4200: 610149114

GM4200: 610149419

GBT4200: 610149319

WLC4190-BASE-WIRELESS-CHARGER: 610150119

WLC4190-BT-BASE-WIRELESS-CHARGER: 610150019

TABLE OF CONTENTS

PREFACE	XI
About this Manual	xi
overview	xi
Manual Conventions	xii
Technical Support	xiii
Support Through the Website	xiii
Reseller Technical Support	xiii
CHAPTER 1. INTRODUCTION	1
About the Scanner	1
Using the Gryphon™ I GD/GBT/GM4200 Reader	1
Battery Safety	2
Programming the Reader	4
Configuration Methods	4
Programming Bar Codes	4
Datalogic Aladdin™	4
CHAPTER 2. SETUP	5
Unpacking	5
Setting Up the Gryphon™ gd4200 reader	5
Connect Host Interface	5
RS-232 Serial Connection	6
Keyboard Wedge Connection	6
USB Connection	6
Stand Installation	8
Hands-Free Stand/Holder	8
Setting Up the Gryphon™ gbt/gm4200 Reader	9
Positioning the Base Station	10
Base Station Positions and Related Clips to be Used	10
Vertical Mount Adapter	12
Reader, Cradle and LEDs Description	14
Connecting the Base Station	15
Base Station Connection and Routing	15
Securing the Cable (Optional)	16
Host Connection	16
Disconnecting the Cable	17
System and Network Layouts	17
Stand Alone Layouts	17
Using the GBT/GM4200 scanner	19
Scanner LEDs	19
Using the WLC4090/4190 Radio Base	19
Radio Base LEDs	19
Replacing the Battery Pack	20
Using the Gryphon™ I GD/GBT/GM4200	21
Linear Bar	22
Linking the Reader	22
Link Datalogic Devices to Base	22
Link Scanner as Serial Device to a Bluetooth Host	22

Link Scanner as HID device to a Bluetooth host	23
Bluetooth Passkey or PIN Code Entry Request	23
Power Off	24
Interface Selection	24
Configuring the Interface	24
Customizing Configuration Settings	28
Using the Programming Bar Codes	28
Datalogic Aladdin™ Utility	28
Interface Settings	28
Configuring Other Features	29
Software Version Transmission	29
Resetting the Product Configuration to Defaults	29
Restore Custom Default Configuration	29
Restore Factory Configuration	30
CHAPTER 3. CONFIGURATION WITH BAR CODES.....	31
Configuration Parameters	31
Interface Configuration:	31
Parameters common to all interface applications:	31
Symbology-specific parameters:	32
GLOBAL INTERFACE FEATURES	33
Host Commands — Obey/Ignore	33
USB Suspend Mode	33
RS-232 INTERFACE	34
RS-232 STANDARD SETTINGS	35
Baud Rate	35
Data Bits	36
Stop Bits	36
Parity	37
Handshaking Control	38
RS-232/USB-COM INTERFACES	39
RS-232/USB-COM SETTINGS	40
Intercharacter Delay	40
Beep On ASCII BEL	41
Beep On Not on File	41
ACK NAK Options	42
ACK Character	43
NAK Character	43
ACK NAK Timeout Value	44
ACK NAK Retry Count	44
ACK NAK Error Handling	45
Indicate Transmission Failure	45
Disable Character	46
Enable Character	46
KEYBOARD INTERFACE	47
COUNTRY MODE	48
Setup on PC to use ALT Universal	48
Setting Country Mode	49
OTHER KEYBOARD PARAMETERS	63
Encoding Type	63
ALT Output Type	70
Caps Lock State	71
Numlock	71
Keyboard Numeric Keypad	72
Keyboard Send Control Characters	72
Wedge Quiet Interval	73
Intercharacter Delay	73
Intercode Delay	74
USB Keyboard Speed	75
USB-OEM INTERFACE	76
USB-OEM Device Usage	77

USB-OEM Interface Options	77
IBM 46XX INTERFACE	78
IBM 46xx Interface Options	79
DATA FORMAT	80
Global Prefix/Suffix	81
Global AIM ID	82
GS1-128 AIM ID	82
LABEL ID	83
Label ID: Pre-loaded Sets	83
Label ID: Set Individually Per Symbology	84
Label ID Control	84
Label ID Symbology Selection	85
Case Conversion	90
Character Conversion	90
READING PARAMETERS	91
SCANNING FEATURES	92
Scan Mode	92
Scanning Active Time	93
Flash On Time	93
Flash Off Time	94
Double Read Timeout	94
Stand /Base Detection Behavior	96
Stand Mode/Object Detection Indication (Stand Mode Flash)	97
Stand Mode/Object Detection Sensitivity	97
Stand Mode/Object Detection Illumination Off Time	98
Corded Stand Mode	98
BEEPER CONTROL	99
Power On Alert	99
.....	99
Good Read Beep Type	99
Good Read Beep Frequency	100
Good Read Beep Length	101
Good Read Beep Volume	102
LED CONTROL	103
RGB Good Read Enable	103
RGB Good Read Color	103
Good Read LED Duration	104
Good Read: When to Indicate	105
Green Spot Duration	106
Illuminator Intensity (Power Level)	106
CAMERA CONTROL	107
Aiming Pointer	107
MOTION FEATURES	108
MOTION FEATURES	109
Motionless Timeout	109
Motion Sensitivity	109
High Motion Immunity	110
Motion Aiming Control	110
SYMBOLOGIES	111
DISABLE ALL SYMBOLOGIES	112
COUPON CONTROL	112
UPC-A	113
UPC-A Enable/Disable	113
UPC-A Check Character Transmission	113
Expand UPC-A to EAN-13	114
UPC-A Number System Character Transmission	114
UPC-E	115
UPC-E Enable/Disable	115
UPC-E Check Character Transmission	115
Expand UPC-E to EAN-13	116
Expand UPC-E to UPC-A	116

UPC-E Number System Character Transmission	116
GTIN Formatting	117
EAN-13	118
EAN-13 Enable/Disable	118
EAN-13 Check Character Transmission	118
EAN-13 Flag 1 Character	119
EAN-13 to ISBN Conversion	119
EAN-13 to ISSN Conversion	120
EAN-8	121
EAN-8 Enable/Disable	121
EAN-8 Check Character Transmission	121
Expand EAN-8 to EAN-13	122
UPC/EAN GLOBAL SETTINGS	123
UPC/EAN Price Weight Check	123
UPC/EAN Quiet Zones	124
Add-Ons	124
Optional Add-ons	125
Optional Add-On Timer	126
GS1 DATABAR™ OMNIDIRECTIONAL	127
GS1 DataBar Omnidirectional Enable/Disable	127
GS1 DataBar Omnidirectional to GS1-128 Emulation	127
GS1 DATABAR™ EXPANDED	128
GS1 DataBar Expanded Enable/Disable	128
GS1 DataBar Expanded to GS1-128 Emulation	128
GS1 DataBar Expanded Length Control	129
GS1 DataBar Expanded Set Length 1	129
GS1 DataBar Expanded Set Length 2	130
GS1 DATABAR™ LIMITED	131
GS1 DataBar Limited Enable/Disable	131
GS1 DataBar Limited to GS1-128 Emulation	131
CODE 39	132
Code 39 Enable/Disable	132
Code 39 Check Character Calculation	132
Code 39 Check Character Transmission	133
Code 39 Start/Stop Character Transmission	133
Code 39 Full ASCII	134
Code 39 Quiet Zones	134
Code 39 Length Control	135
Code 39 Set Length 1	135
Code 39 Set Length 2	136
TRIOPTIC CODE	137
Trioptic Code Enable/Disable	137
CODE 39 DANISH PPT	137
Code 39 Danish PPT Enable/Disable	137
CODE 39 PZN	138
Code 39 PZN Enable/Disable	138
CODE 39 LA POSTE	138
Code 39 La Poste Enable/Disable	138
CODE 32 (ITALIAN PHARMACEUTICAL)	139
Code 32 Enable/Disable	139
Code 32 Feature Setting Exceptions	139
Code 32 Check Character Transmission	139
Code 32 Start/Stop Character Transmission	140
CODE 39 CIP (FRENCH PHARMACEUTICAL)	140
Code 39 CIP Enable/Disable	140
CODE 128	141
Code 128 Enable/Disable	141
Expand Code 128 to Code 39	141
Code 128 Check Character Transmission	142
Code 128 Function Character Transmission	142
Code 128 Quiet Zones	143

Code 128 Length Control	143
Code 128 Set Length 1	144
Code 128 Set Length 2	144
GS1-128	145
GS1-128 Enable	145
INTERLEAVED 2 OF 5 (1 2 OF 5)	145
1 2 of 5 Enable/Disable	146
1 2 of 5 Check Character Calculation	146
1 2 of 5 Check Character Transmission	147
1 2 of 5 Length Control	148
1 2 of 5 Set Length 1	148
1 2 of 5 Set Length 2	149
INTERLEAVED 2 OF 5 CIP HR	149
Interleaved 2 of 5 CIP HR Enable/Disable	149
STANDARD 2 OF 5	150
Standard 2 of 5 Enable/Disable	150
Standard 2 of 5 Check Character Calculation	150
Standard 2 of 5 Check Character Transmission	151
Standard 2 of 5 Length Control	151
Standard 2 of 5 Set Length 1	152
Standard 2 of 5 Set Length 2	152
COMPRESSED 2 OF 5	153
Compressed 2 of 5 Enable/Disable	153
Compressed 2 of 5 Check Character Calculation	153
Compressed 2 of 5 Check Character Transmission	154
Compressed 2 of 5 Length Control	154
Compressed 2 of 5 Set Length 1	155
Compressed 2 of 5 Set Length 2	155
DATALOGIC 2 OF 5	156
Datalogic 2 of 5 Enable/Disable	156
Datalogic 2 of 5 Check Character Calculation	156
Datalogic 2 of 5 Check Character Transmission	157
Datalogic 2 of 5 Length Control	157
Datalogic 2 of 5 Set Length 1	158
Datalogic 2 of 5 Set Length 2	158
INDUSTRIAL 2 OF 5	159
Industrial 2 of 5 Enable/Disable	159
Industrial 2 of 5 Check Character Calculation	159
Industrial 2 of 5 Check Character Transmission	160
Industrial 2 of 5 Length Control	160
Industrial 2 of 5 Set Length 1	161
Industrial 2 of 5 Set Length 2	161
IATA	162
IATA Enable/Disable	162
IATA Check Character Transmission	162
FOLLETT 2 OF 5	163
Follett 2 of 5 Enable/Disable	163
CODABAR	164
Codabar Enable/Disable	164
Codabar Check Character Calculation	164
Codabar Check Character Transmission	165
Codabar Start/Stop Character Transmission	165
Codabar Start/Stop Character Set	166
Codabar Start/Stop Character Match	166
Codabar Quiet Zones	167
Codabar Length Control	168
Codabar Set Length 1	168
Codabar Set Length 2	169
ABC CODABAR	170
ABC Codabar Enable/Disable	170
ABC Codabar Concatenation Mode	170

ABC Codabar Dynamic Concatenation Timeout	171
ABC Codabar Force Concatenation	171
ISBT 128	172
ISBT 128 Concatenation	172
ISBT 128 Concatenation Mode	172
ISBT 128 Dynamic Concatenation Timeout	173
ISBT 128 Force Concatenation	174
ISBT 128 Advanced Concatenation Options	174
CODE 11	175
Code 11 Enable/Disable	175
Code 11 Check Character Calculation	175
Code 11 Check Character Transmission	176
Code 11 Length Control	176
Code 11 Set Length 1	177
Code 11 Set Length 2	177
CODE 93	178
Code 93 Enable/Disable	178
Code 93 Check Character Calculation	178
Code 93 Check Character Transmission	179
Code 93 Length Control	179
Code 93 Set Length 1	180
Code 93 Set Length 2	180
Code 93 Quiet Zones	181
MSI	182
MSI Enable/Disable	182
MSI Check Character Calculation	182
MSI Check Character Transmission	183
MSI Length Control	183
MSI Set Length 1	184
MSI Set Length 2	184
PLESSEY	185
Plessey Enable/Disable	185
Plessey Check Character Calculation	185
Plessey Check Character Transmission	186
Plessey Length Control	186
Plessey Set Length 1	187
Plessey Set Length 2	187
BC412	188
BC412 Enable/Disable	188
BC412 Check Character Calculation	188
BC412 Length Control	189
BC412 Set Length 1	190
BC412 Set Length 2	190
POWER MANAGEMENT	191
POWER SAVE	192
Powerdown Timeout	192
BATTERY PROFILES	193
Battery Profiles	193
Battery Information	194
WIRELESS FEATURES	195
WIRELESS BEEPER FEATURES	196
Good Transmission Beep	196
Beeper Frequency	196
Beep Duration	197
Beep Volume	198
Disconnect Beep	198
Docking (Connecting) Beep	199
Leash Alarm	199
CONFIGURATION UPDATES	201
Automatic Configuration Update	201
Copy Configuration to Scanner	201

Copy Configuration to Base Station	201
BATCH FEATURES	202
Batch Mode	202
Send Batch	202
Erase Batch Memory	203
RF Batch Mode Transmit Delay	203
DIRECT RADIO AUTOLINK	204
Direct Radio Autolink	204
RF ADDRESS STAMPING	205
Source Radio Address Transmission	205
Source Radio Address Delimiter Character	205
BLUETOOTH-ONLY FEATURES	206
Bluetooth Security Level	206
Bluetooth Radio Output Power	207
Wi-Fi Channels Exclusion	208
BLUETOOTH HID FEATURES	213
Bluetooth HID Alt Mode	213
FEATURES FOR STAR MODELS ONLY	214
STAR Radio Protocol Timeout	214
STAR Radio Transmit Mode	215
STAR System Speed	216
STAR Frequency Agility	217

CHAPTER 4. REFERENCES..... 219

RS-232 Parameters 220

RS-232 Only 220

Baud Rate	220
Data Bits	220
Stop Bits	220
Parity	220
Handshaking Control	220

RS-232/USB COM Parameters 221

Intercharacter Delay	221
ACK NAK Options	222
ACK Character	222
NAK Character	223
ACK NAK Timeout Value	224
ACK NAK Retry Count	225
Disable Character	226
Enable Character	227

Keyboard Interface 228

Wedge Quiet Interval	228
Intercharacter Delay	229
Intercode Delay	230

Data Format 231

Data Editing	231
Please Keep In Mind...	231
Global Prefix/Suffix	232
Example: Setting a Prefix	232
Global AIM ID	233
Label ID	234
Label ID: Pre-loaded Sets	234
Label ID: Set Individually Per Symbology	236
Character Conversion	238

Scanning Features 239

Scan Mode	239
Scanning Active Time	240
Aiming Duration Time	241
Flash On Time	242
Flash Off Time	243

LED and Beeper Indicators 244

Good Read LED Duration	244
RF Features	245
Automatic Configuration Update	245
RF Address Stamping	245
Source Radio Address Delimiter Character	245
STAR Radio Protocol Timeout	246
Symbologies	247
Set Length	247
Set Length 1	247
Set Length 2	248
CHAPTER 5. MESSAGE FORMATTING	249
Message Formatting	249
LED and Beeper Control	250
APPENDIX A. TECHNICAL SPECIFICATIONS	251
GD4200 Technical Specifications	251
GBT/GM4200 Technical Specifications	252
Common Reading Characteristics	254
Decoding Capabilities	255
LED and Beeper Indications	255
User Indications for GD4200	256
User Indications for GBT/GM4200 (Gun Only)	256
User Indications for WLC4190 Base Stations	258
Programming Mode	259
Troubleshooting	259
Standard Cable Pinouts	260
APPENDIX B. STANDARD DEFAULTS	261
Default exceptions	270
APPENDIX C. SAMPLE BARCODES	272
Sample Barcodes	272
1D Barcodes	272
GS1 Databar™ (RSS)	274
GS1 Databar™ (-14)	274
APPENDIX D. KEYPAD	275
APPENDIX E. SCANCODE TABLES	277
Control Character Emulation	277
Single Press and Release Keys	277
Interface Type PC AT PS/2, USB-Keyboard or USB-Keyboard for APPLE	278
Interface Type PC AT PS/2, USB-Keyboard or USB-Keyboard for APPLE (continued)	279
Interface Type PC AT PS/2 Alt Mode or USB-Keyboard Alt Mode	280
Interface Type PC AT PS/2 Alt Mode or USB-Keyboard Alt Mode (continued)	281
Digital Interface	282
IBM31xx 102-key	283
IBM XT	285
Microsoft Windows Codepage 1252	287
APPENDIX F. ASCII CHART	288

PREFACE

ABOUT THIS MANUAL

This Product Reference Guide (PRG) is provided for users seeking advanced technical information, including connection, programming, maintenance and specifications. The Quick Reference Guide (QRG) and other publications associated with this product are downloadable free of charge from the website listed on the back cover of this manual.

Typically, units are factory-programmed for the most common terminal and communications settings. If you need to modify any programmable settings, custom configuration can be accomplished by scanning the programming bar codes within this guide.

Programming can alternatively be performed using the Datalogic Aladdin™ Configuration application, which is available from the Datalogic website listed on the back cover of this manual. This multi-platform utility program allows device configuration using a PC. It communicates to the device using a serial or USB cable and can also create configuration bar codes to print.

OVERVIEW

Chapter 1, Introduction provides a product overview, unpacking instructions, and cable connection information.

Chapter 2, Setup presents information about unpacking and setting up the scanner, and interface configuration bar codes and details.

Chapter 3, Configuration Using Bar Codes provides instructions and bar code labels for customizing your scanner. There are different sections for interface types, general features, data formatting, and symbology-specific features.

Chapter 4, References provides details concerning programmable features.

Appendix A, Technical Specifications lists physical and performance characteristics, as well as environmental specifications. It also provides standard cable pin-outs and descriptions of the functions and behaviors of the scanner's LED and Speaker indicators.

Appendix B, references common factory default settings for scanner features and options.

Appendix C, Sample Bar Codes offers sample bar codes of several common symbologies.

Appendix D, Keypad includes numeric bar codes to be scanned for certain parameter settings.

Appendix E, Scancode Tables lists control character emulation information for Wedge and USB Keyboard interfaces.

Appendix F, ASCII Chart lists hexadecimal reference values for ASCII characters.

Manual Conventions

The following conventions are used in this document:

The symbols listed below are used in this manual to notify the reader of key issues or procedures that must be observed when using the reader:



NOTE: This symbol draws attention to details or procedures that may be useful in improving, maintaining, or enhancing the performance of the hardware or software being discussed.



CAUTION: This symbol advises you of actions that could damage equipment or property.



WARNING: This symbol advises you of actions that could result in harm or injury to the person performing the task.



HIGH VOLTAGE: This symbol alerts the user they are about to perform an action involving, either a dangerous level of voltage, or to warn against an action that could result in damage to devices or electrical shock.



LASER: This symbol alerts the user they are about to perform an action involving possible exposure to laser light radiation.



GROUNDING: This symbol advises you to pay particular attention to the grounding instructions for correct device functioning.



ESD: This symbol identifies a procedure that requires you take measures to prevent Electrostatic Discharge (ESD) e.g., use an ESD wrist strap. Circuit boards are most at risk. Please follow ESD procedures.

TECHNICAL SUPPORT

Support Through the Website

Datalogic provides several services as well as technical support through its website. Log on to (www.datalogic.com).

For quick access, from the home page click on the search icon , and type in the name of the product you're looking for. This allows you access to download Data Sheets, Manuals, Software & Utilities, and Drawings.

Hover over the Support & Service menu for access to Services and Technical Support.

Reseller Technical Support

An excellent source for technical assistance and information is an authorized Datalogic reseller. A reseller is acquainted with specific types of businesses, application software, and computer systems and can provide individualized assistance.

NOTES

CHAPTER 1

INTRODUCTION

ABOUT THE SCANNER

With rich feature sets and extensive model options, the Gryphon™ product series from Datalogic represents the premium level of data collection equipment for general purpose applications.

The Gryphon I GD4200 readers' ability to capture bar codes from near to far, to read both high-density and low resolution codes, to decode hard-to-read, poor or damaged codes and to easily read bar codes from mobile devices make these readers the perfect choice for today's and tomorrow's applications in retail and office environments, pharmacies, light industrial, warehouses and manufacturing plants.

USING THE GRYPHON™ I GD/GBT/GM4200 READER

To read a symbol or capture an image, simply aim the reader and pull the trigger. Datalogic's exclusive patented 'Green Spot' for good-read feedback helps to improve productivity in noisy environments or in situations where silence is required. When positioning the product into the stand, the magnetic coupling will make the scanner automatically detect a bar code inside the field of view, and switch the reading system from trigger mode to autosense mode.

The Gryphon™ I GD4200 reliably decodes all standard 1D (linear) including GS1 DataBar™ linear codes, Postal Codes (China Post). The data stream - acquired from decoding a symbol - is rapidly sent to the host. The reader is immediately available to read another symbol.

Figure 1 - Correct positioning of the scanner



BATTERY SAFETY

To reinstall, charge and/or perform any other action on the battery, follow the instructions in this manual.



NOTE: Before installing the Battery, read “Battery Safety” on this and the following pages. Datalogic recommends annual replacement of rechargeable battery packs to ensure maximum performance.



WARNING: Do not discharge the battery using any device except for the scanner. When the battery is used in devices other than the designated product, it may damage the battery or reduce its life expectancy. If the device causes an abnormal current to flow, it may cause the battery to become hot, explode or ignite and cause serious injury.

Lithium-ion battery packs may get hot, explode or ignite and cause serious injury if exposed to abusive conditions. Be sure to follow the safety warnings listed below:

- Do not place the battery pack in fire or heat.
- Do not connect the positive terminal and negative terminal of the battery pack to each other with any metal object (such as wire).
- Do not carry or store the battery pack together with metal objects.
- Do not pierce the battery pack with nails, strike it with a hammer, step on it or otherwise subject it to strong impacts or shocks.
- Do not solder directly onto the battery pack.
- Do not expose the battery pack to liquids, or allow the battery to get wet.
- Do not apply voltages to the battery pack contacts.

In the event the battery pack leaks and the fluid gets into your eye, do not rub the eye. Rinse well with water and immediately seek medical care. If left untreated, the battery fluid could cause damage to the eye.



CAUTION: Always charge the battery at 32° – 104°F (0° - 40°C) temperature range.

Use only the authorized power supplies, battery pack, chargers, and docks supplied by your Datalogic reseller. The use of any other power supplies can damage the device and void your warranty.

Do not disassemble or modify the battery. The battery contains safety and protection devices, which, if damaged, may cause the battery to generate heat, explode or ignite.

Do not place the battery in or near fire, on stoves or other high temperature locations.

Do not place the battery in direct sunlight, or use or store the battery inside cars in hot weather. Doing so may cause the battery to generate heat, explode or ignite. Using the battery in this manner may also result in a loss of performance and a shortened life expectancy.

Do not place the battery in microwave ovens, high-pressure containers or on induction cookware.

Immediately discontinue use of the battery if, while using, charging or storing the battery, the battery emits an unusual smell, feels hot, changes color or shape, or appears abnormal in any other way.

Do not replace the battery pack when the device is turned on.

Do not remove or damage the battery pack's label.

Do not use the battery pack if it is damaged in any part.

Battery pack usage by children should be supervised.



CAUTION: Storage of batteries for long time at fully charged status or at fully discharged status should be avoided.



CAUTION: Only in case of long storage, to avoid deep discharge of the battery it is recommended to partially recharge the battery every three months to keep the charge status at a medium level.

As a reference, run a fast recharge for 20 minutes every three months on unused products to avoid any performance deterioration of the cell.

As with other types of batteries, Lithium-Ion (LI) batteries will lose capacity over time. Capacity deterioration is noticeable after one year of service whether the battery is in use or not. It is difficult to precisely predict the finite life of a LI battery, but cell manufacturers rate them at 500 charge cycles. In other words, the batteries should be expected to take 500 full discharge / charge cycles before needing replacement. This number is higher if partial discharging / recharging is adhered to rather than full / deep discharging,

The typical manufacturer advertised useful life of LI batteries is one to three years, depending on usage and number of charges, etc., after which they should be removed from service, especially in mission critical applications. Do not continue to use a battery that is showing excessive loss of capacity, it should be properly recycled / disposed of and replaced. For most applications, batteries should be replaced after one year of service to maintain customer satisfaction and minimize safety concerns.

Collect and recycle waste batteries separately from the device in compliance with European Directive 2006/66/EC, 2011/65/EU, 2002/96/EC and 2012/19/EU and subsequent modifications, US and China regulatory and others laws and regulations about the environment.

PROGRAMMING THE READER

Configuration Methods

Programming Bar Codes

The reader is factory-configured with a standard set of default features. After scanning the interface bar code, you can select other options and customize your reader through use of the instructions and programming bar code labels available in the corresponding features section for your interface. Customizable settings for many features are found in [Configuration Parameters, starting on page 31](#).

Some programming labels, like “Restore Custom Defaults”, require only the scan of the single label to enact the change. Most, however, require the reader to be placed in Programming Mode prior to scanning them. Scan an ENTER/EXIT bar code once to enter Programming Mode. Once the reader is in Programming Mode, scan a number of parameter settings before scanning the ENTER/EXIT bar code a second time, which will then accept your changes, exit Programming Mode and return the reader to normal operation.



NOTE: There are some exceptions to the typical programming sequence described above. Please read the description and setting instructions carefully when configuring each programmable feature.

Datalogic Aladdin™

Datalogic Aladdin™ is a multi-platform utility program providing a quick and user-friendly configuration method via the RS-232/USB-COM interface. Aladdin allows you to program the reader by selecting configuration commands through a user-friendly graphical interface running on a PC. These commands are sent to the reader over the selected communication interface, or they can be printed as bar codes to be scanned. Aladdin also facilitates image capturing.

In addition, Aladdin makes it easy to upgrade the handheld's firmware, to attain the benefits of new reader features. Reference the Datalogic Aladdin™ Online Help for more details.

Aladdin is available for download free of charge on the Datalogic website.

CHAPTER 2

SETUP

UNPACKING

Check carefully to ensure the scanner and any cables or accessories ordered are present and undamaged. If any damage occurred during shipment, contact "[Technical Support](#)" on page xiii.

SETTING UP THE GRYPHON™ GD4200 READER

Follow the steps provided in this section to connect and get your reader up and communicating with its host:

1. Connect the Interface Cable to the reader as shown in Figure 2. To disconnect the cable, insert a paper clip or similar object into the opening shown.
2. Connect the other end to the Host (see the next section, "[Connect Host Interface](#)" on page 5 and Figure 3).
3. Modify "[Customizing Configuration Settings](#)" on page 28 (only if modifications are needed from factory settings).

CONNECT HOST INTERFACE

The scanner kit you ordered to match your interface should provide a compatible cable for your installation. If this is not so, contact "[Technical Support](#)" on page xiii.

The scanner can communicate using the interfaces illustrated below.

For corded versions, connect the reader cable by inserting the cable into the handle as shown in the following Figure.

To remove the interface cable from the reader, first locate the hole on the back of the handle. Next, take a paper clip and modify it as shown in the figure below. Insert the end of the paper clip into the hole and press it to push on the clip that holds the connector. As you apply pressure, pull out the cable.

When reinserting the cable, make sure the connector clip is on the same side as the reader release hole. Insert the cable, it should click when it is fully inserted.



NOTE: We recommend the use of a perfectly straight new paper clip to make the operation easier (see the figure below).

Figure 2. Cable Connection/Disconnection at the Scanner

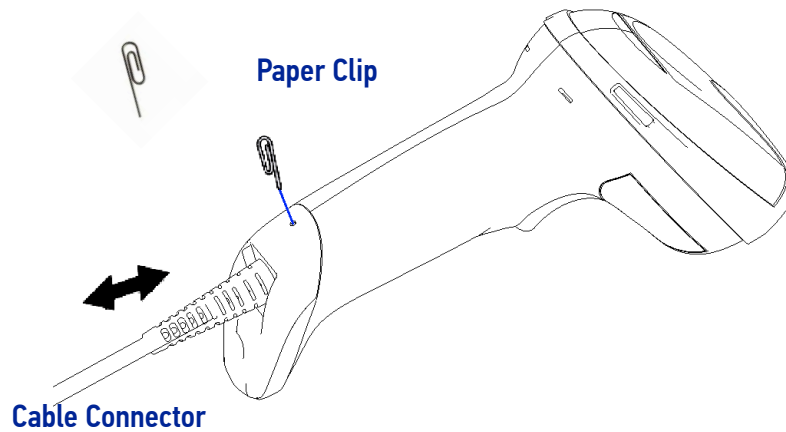

RS-232 Serial Connection

Turn off power to the terminal/PC and connect the scanner to the terminal/PC serial port via the RS-232 cable as shown in Figure 3. If the terminal will not support POT (Power Off the Terminal) to supply scanner power, use the approved power supply (AC Adapter). Plug the AC Adapter barrel connector into the socket on the RS-232 cable connector and the AC Adapter plug into a standard power outlet.

RS-232: The scanner can communicate with a standard or Wincor-Nixdorf (W-N) RS-232 host.

RS-232 OPOS: This interface is used for OPOS/UPOS/JavaPOS systems.

Keyboard Wedge Connection

The Keyboard Wedge cable has a 'Y' connection from the scanner. Connect the female to the male end from the keyboard and the remaining end at the keyboard port at the terminal/PC.

Keyboard Wedge (KBW): When connected using this interface, the host interprets scanned data as keystrokes and supports several international keyboards (for the Windows® environment). See "Setting Country Mode" on page 49 for a full listing.

USB Connection

Connect the scanner to a USB port on the terminal/PC using the correct USB cable for the interface type you ordered.

USB: Select to communicate either by USB OEM, USB COM STD, or USB Keyboard interface types by scanning the appropriate interface type bar codes available in this manual. The default interface is USB-KBD, or RS-232-STD.

Figure 3 - Connection to the Host

USB



WEDGE



RS-232



NOTE: Specific cables are required for connection to different hosts. The connections illustrated in Figure 3 are examples only. Actual connectors may vary from those illustrated, but the steps to connect the scanner remain the same.

STAND INSTALLATION

Hands-Free Stand/Holder

An accessory is available which holds the reader (except those with integrated stand) at a convenient angle, allowing hands free scanning of items.

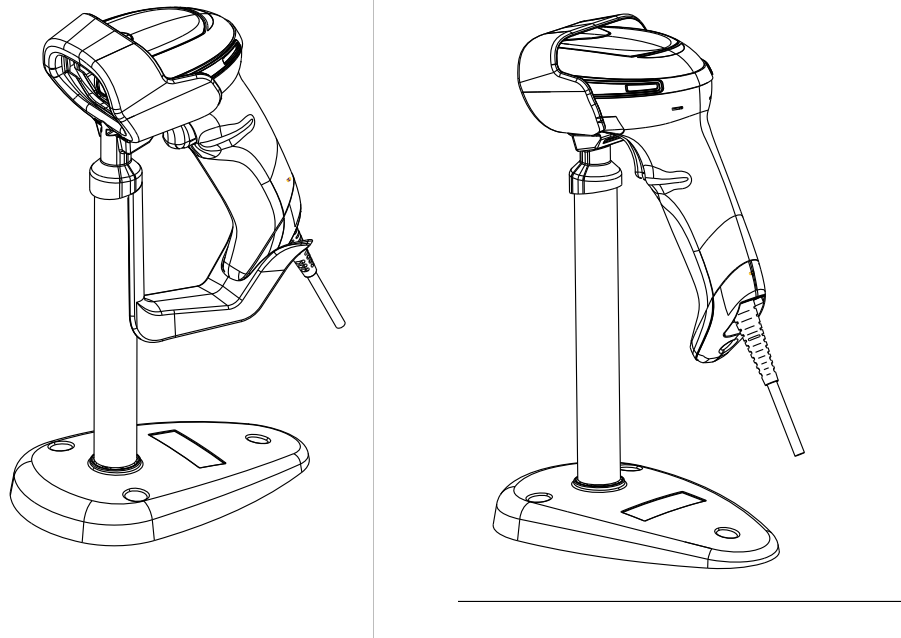

It can also be used as a holder. The holder “cup” can be positioned in any of the angles shown in the figure below. The Desk model automatically recognizes the insertion and changes its Scan Mode to allow the user to operate in hands-free mode.

Figure 4 - Adjusting the Stand Arm

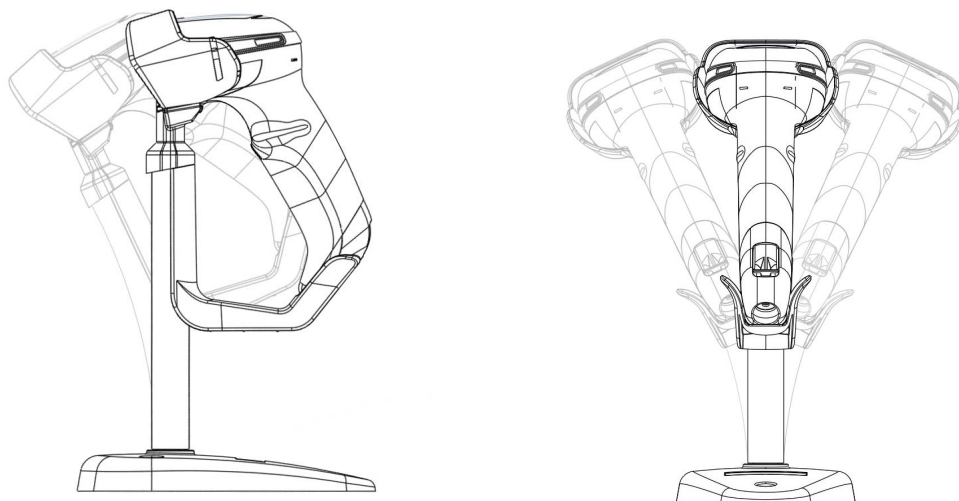

SETTING UP THE GRYPHON™ GBT/GM4200 READER

Follow the steps below to connect and get your reader up and communicating with its host.

1. Configure the Base Station starting on [page 15](#)
2. Link to the Base Station on [page 22](#)
3. Select the Interface Type on [page 24](#).



NOTE: According to recent modification of Regulation for shipping Li-Ion based battery packs, the products and their spare battery packs parts are shipped with a very low residual charge (low state of charge).

Hence the needs

*** that a new product must be fully recharged before starting to use it.**

and

*** that battery packs of the stocked products GBT/GM42 and spare battery pack parts must be periodically recharged: for instance by using a WLC4190 or a WLC4090 cradle powered up with a 12V Datalogic AC/DC adapter (cod.8-0935) or a USB Type-C cable for at least 30 minutes each 3 months.**

POSITIONING THE BASE STATION

The base station/charger may be set up in desk application to hold the reader in two different positions, either a horizontal or vertical position, in order to provide the most comfortable use depending on the needs.

Base Station Positions and Related Clips to be Used

Figure 5 - Horizontal Position

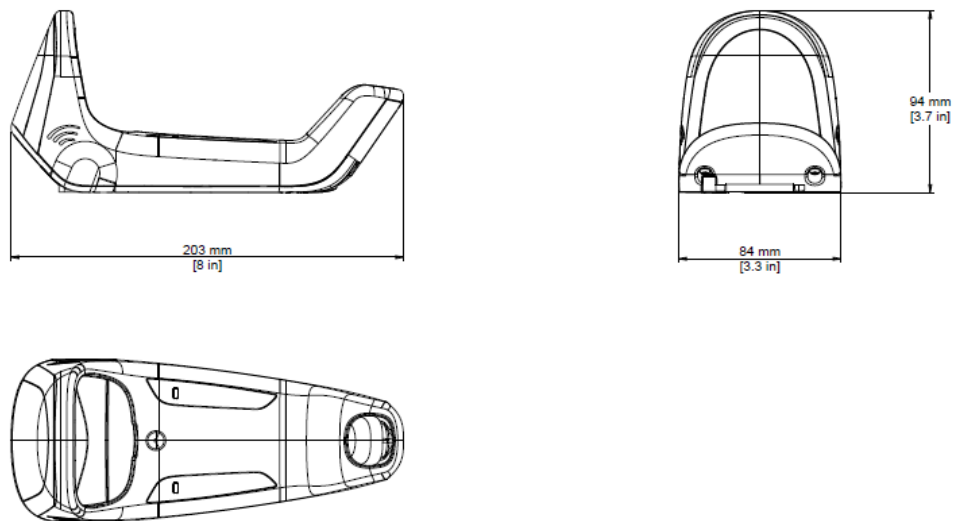

This position is preferred, unless a different specific positioning is required, for its utmost ease of insertion as well as the minimum effort and attention required by the customer when docking the scanner.

Figure 6 - Vertical Position



This position is preferred when lack of room on the desktop recommends the scanner to be left vertical during recharging.

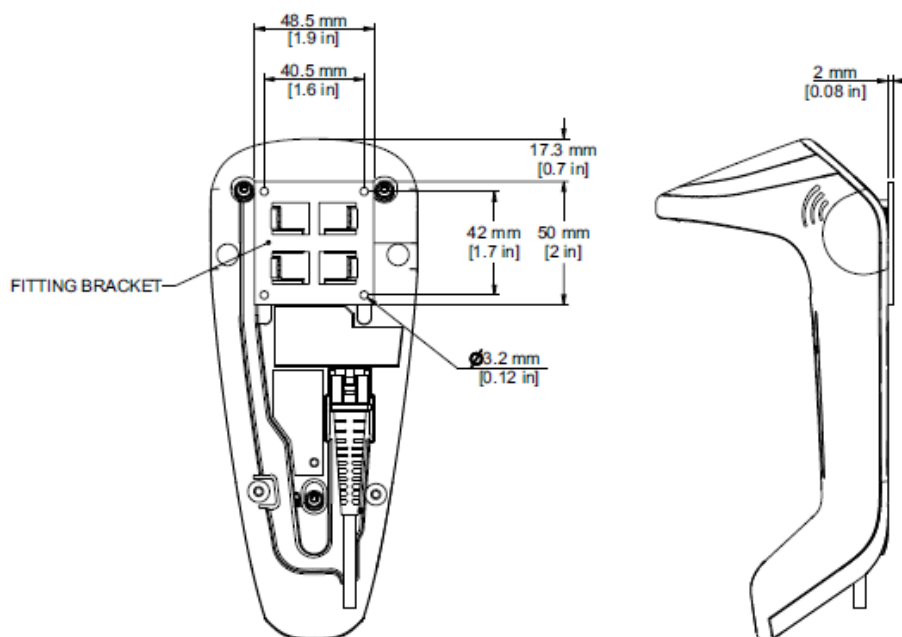

NOTE: For vertical installation, do not exceed two meters in height.

Vertical Mount Adapter

An accessory is available to be ordered separately (not supplied), for the vertical mount position.

Figure 7 - Fixing the Adapter

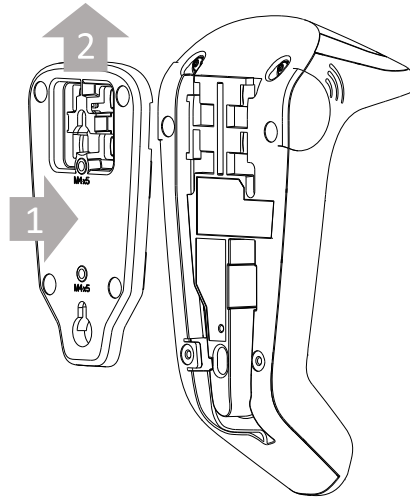

Pair the adapter to the base and then slide it upwards, as indicated by the arrows, to snap the adapter into the base.

Figure 8 - Fixed Vertical Mount

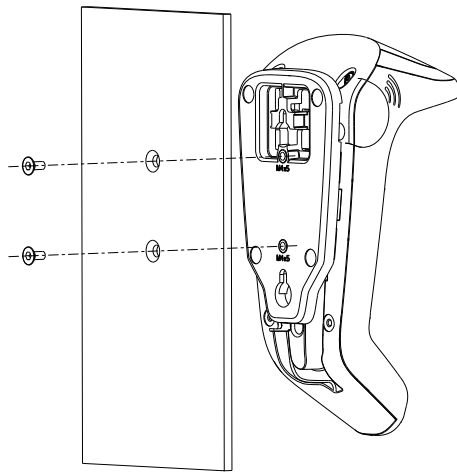
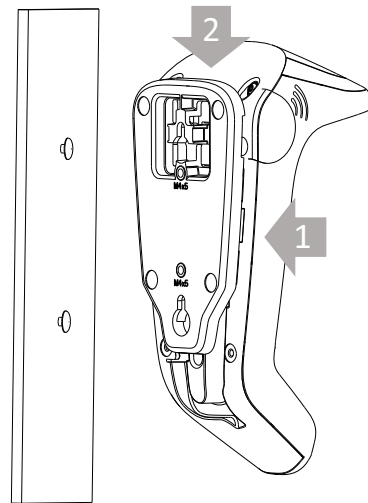

Figure 9 - Removable Vertical Mount



Fix the base-adapter unit to the wall/panel Insert the two studs into the keyhole of using two screws. Refer to Figure 10 for the adapter. Swipe down to block the studs the positioning and the dimensions of the threaded brass screw holes.

Refer to Figure 10 for the positioning and the dimensions of the keyhole mounting holes.

Figure 10 - Mounting Holes Dimensions

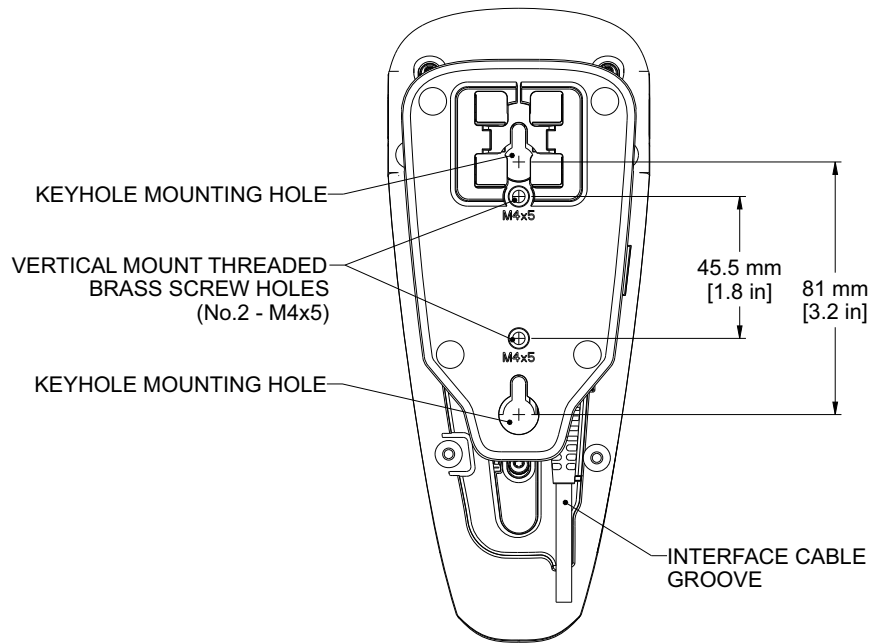
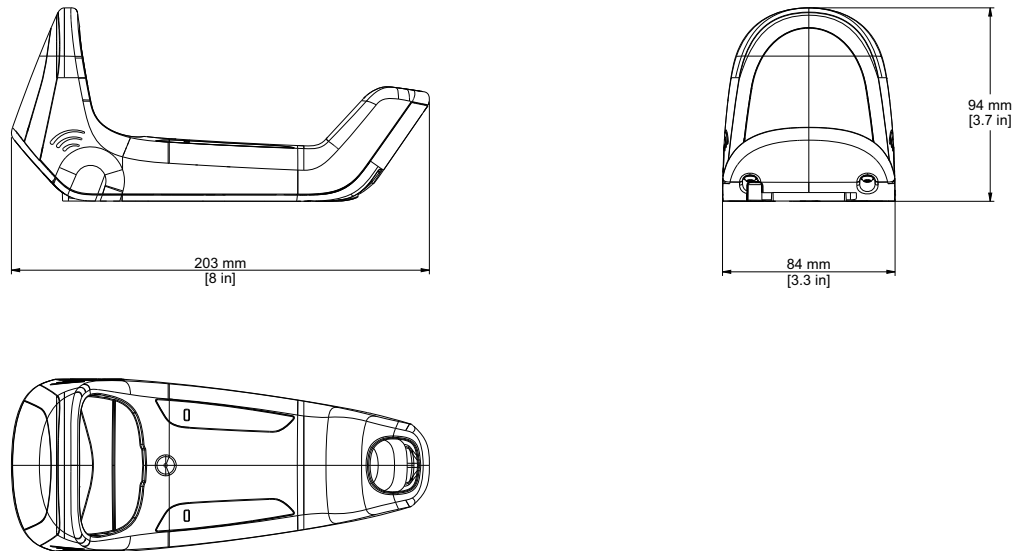

Figure 11 - Overall Dimensions



READER, CRADLE AND LEDS DESCRIPTION

LEDs on the gun provide information about the battery charging status as well as data transmission.

Figure 12 - Gryphon 4200 Gun LEDs

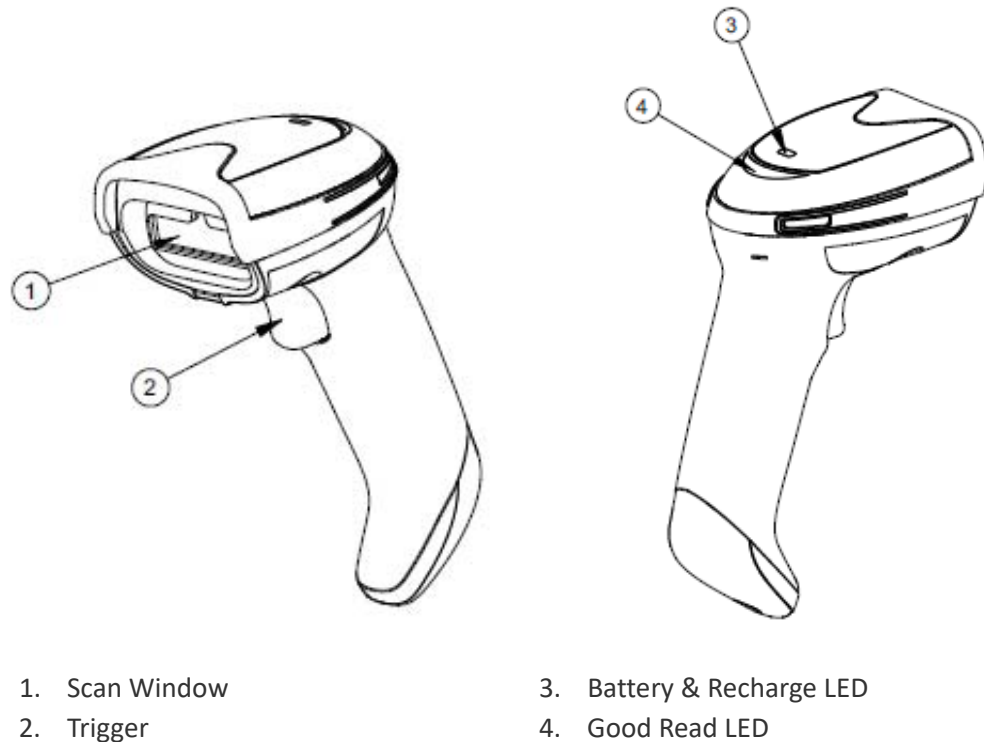
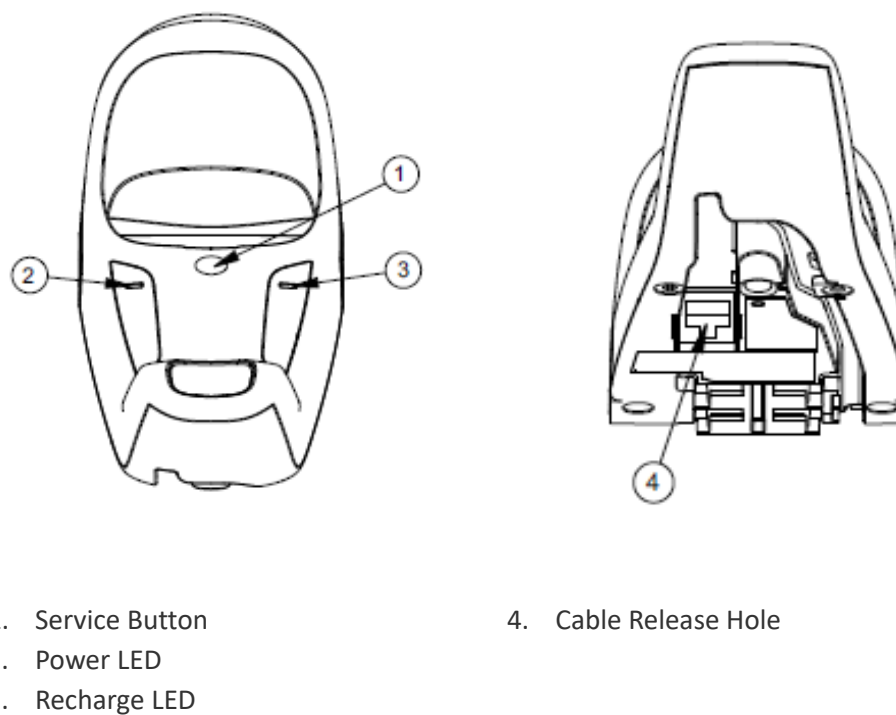

Figure 13 - WLC4190 Base Station LEDs



CONNECTING THE BASE STATION

The following figure shows how to connect the Base Station to a terminal, PC or other host device. Turn off the host before connection and consult the manual for that equipment (if necessary) before proceeding. Connect the interface cable before applying power to the Base Station.



NOTE: The Gryphon GBT/GM4200 can also be Powered by the Terminal. When powered by the Terminal, the battery charger is automatically set to Slow charge.

For some specific interfaces or hosts or lengths of cable, the use of an external power supply is recommended for full recharging capability (see GBT/GM4200 Technical Specifications, starting on page 252 for more details).

Base Station Connection and Routing

Fully insert the Power Cable and Interface (I/F) Cable connectors into their respective ports in the underside of the Base Station. Then connect to an AC Adapter, and plug the AC power cord into the (wall) outlet.

Figure 14 - Connecting the Base Station

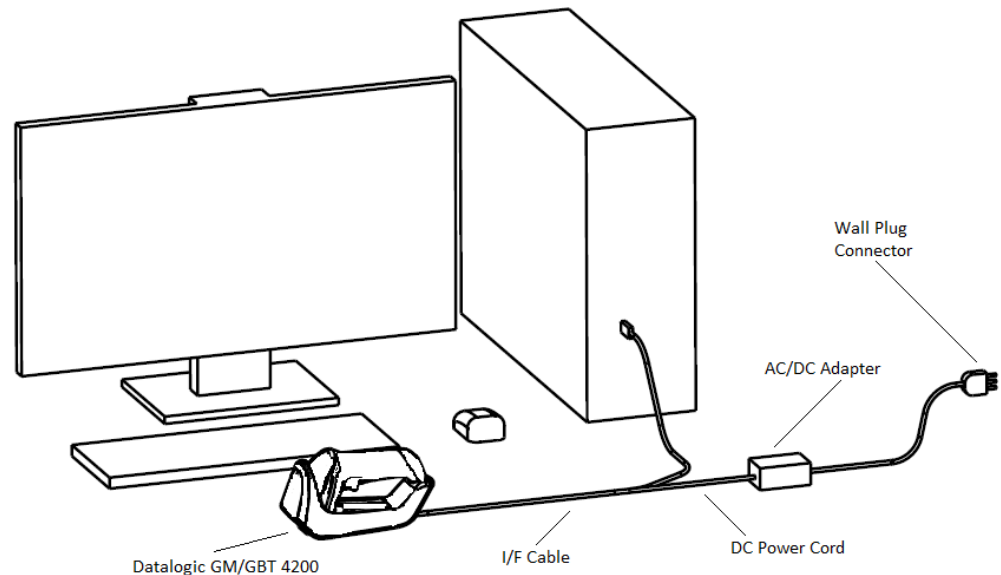

Securing the Cable (Optional)

The interface cable can be secured to the bottom of the base in order to maximize the mechanical retention of the cable itself. The routing of the cable can be changed to accommodate base station positioning: horizontal or vertical mount. The cable can be looped around to the front of the Base Station, or fed directly out the back of the Base Station, as shown in the figure below.

Figure 15 - Options for routing the cable



Host Connection

Verify before connection that the reader's cable type is compatible with your host equipment. Most connections plug directly into the host device as shown in Figure 16. Keyboard Wedge interface cables have a 'Y' connection where its female end mates with the male end of the cable from the keyboard and the remaining end at the keyboard port on the terminal/PC.

Figure 16 - Connecting to the Host



Disconnecting the Cable

To detach the cable from the WLC4190, press down the cable's lever on the bottom side of the cradle.

Figure 17 - Disconnecting the Cable from WLC4190



NOTE: To detach the cable from the WLC4090 base station, please refer to the procedure illustrated in Gryphon I 4500 Family Product Reference Guide, available on www.datalogic.com.

SYSTEM AND NETWORK LAYOUTS

Stand Alone Layouts

Figure 18 - Single Reader Layout

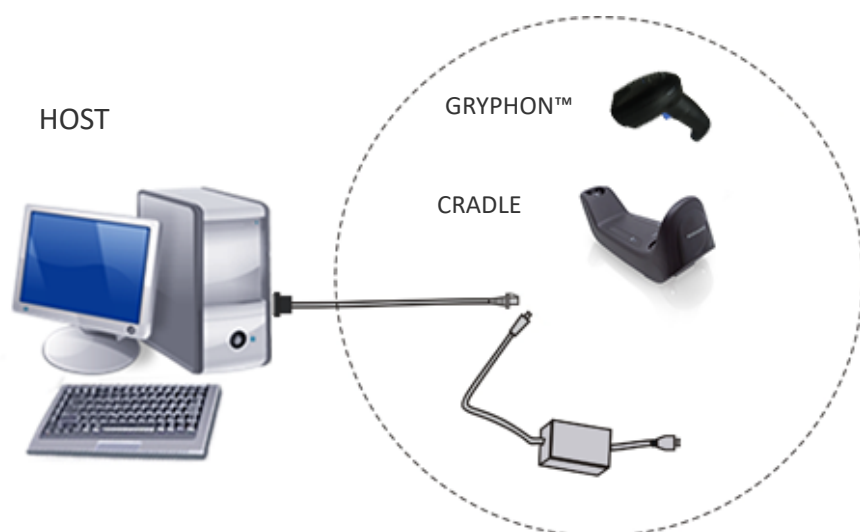
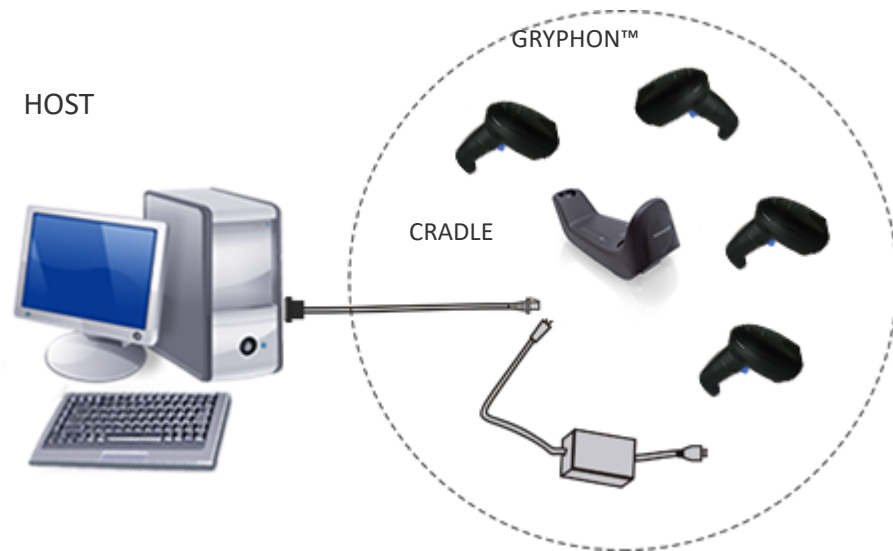
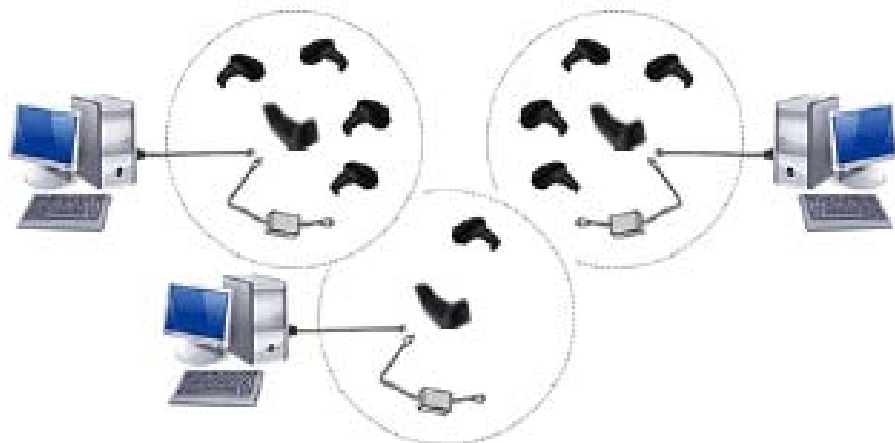

Figure 19 - Multiple Reader Layout



In stand alone systems, each cradle is connected to a single Host.

Figure 20 - Multiple Stand Alone Layouts



Many stand alone connections can operate in the same physical area without interference, provided all readers and cradles in the system have different addresses.

USING THE GBT/GM4200 SCANNER

Scanner LEDs

Specific LEDs on the Gryphon Scanner provide information about: good reading result (3GL), battery status. The Battery Status information can be easily retrieved by double-tapping with your fingers on top of the head of the scanner. The following table explains the main color combinations provided by the Battery Status LED.

Table 1 - Battery LED

LED	STATUS
Green (3s time-out)	Battery Status (when not in charge) = 50% - 100%
Amber (3s time-out)	Battery Status (when not in charge) = 2% - 50%
Red blinking	Charge less than 2%

USING THE WLC4090/4190 RADIO BASE

Radio Base LEDs

LEDs on the Gryphon Base provide information about the Base as well as battery charging status, as shown in the figure below.

Figure 21 - Gryphon Base LEDs



Table 2 - Radio Base LEDs

LED	STATUS
1 Power on / Data	Green On = Base is powered Green Blinking = Base receives data and commands from the Host or the Reader.
2 Charging	Green ON = the battery is completely charged Green fading = battery level 51 to 99% Amber fading = battery level 0 to 50% Red fading = pre.charge

The capacitive touch button can be used to force device connection via the Datalogic Aladdin Software tool and for paging the scanner when it is activated. See also [User Indications for WLC4190 Base Stations](#), starting on page 258.

REPLACING THE BATTERY PACK



NOTE: Before proceeding, read “Battery Safety” on page 2. To ensure maximum performance, Datalogic recommends the replacement of the rechargeable battery pack if you note either of the following conditions:

- battery life drops below approximately 80% of the original life;
- battery charging time increases significantly.

Use the following procedure to change the reader’s battery:

1. With a screwdriver, unscrew the battery cover screw.



2. Carefully remove the battery cable out of its connector and extract the battery pack from its slot.



3. Insert the new battery in the same position.



4. Plug the battery cable into its connector.



NOTE: When inserting the new battery into the handle, take care to position the battery and the connector as illustrated above.

5. Insert the cover in the handle and screw it into place.

USING THE GRYPHON™ I GD/GBT/GM4200

The Gryphon™ I GD4200 normally functions by capturing and decoding codes. The aiming system is activated on trigger pull and indicates the center of the field of view which should be positioned over the bar code:

Aiming System



Relative Size and Location of Aiming System Pattern

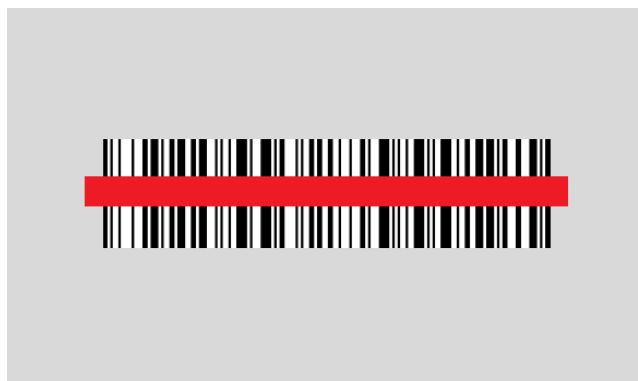

Linear Bar

A red beam illuminates the label. The field of view indicated by the aiming system will be smaller when the reader is closer to the bar code and larger when it is farther from the code. Symbologies with smaller bars or elements (mil size) should be read closer to the unit. Symbologies with larger bars or elements (mil size) should be read farther from the unit. If the aiming system is centered and the entire bar code is within the aiming field, you will get a good read. Successful reading is signaled by an audible tone plus a good-read green spot LED indicator.

Relative Size and Location of Green Spot

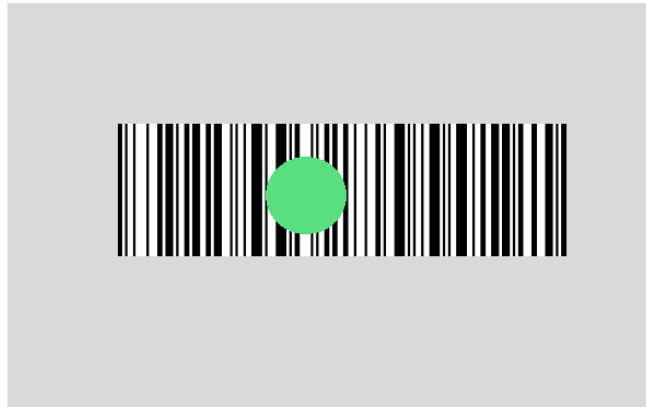

LINKING THE READER

Link Datalogic Devices to Base

Before configuring the interface it is necessary to link the handheld with the base.

To link the handheld and the base simply put it into the base. If the reader was previously linked to another base, you must first scan the Unlink bar code before re-linking to the new base.



Link Scanner as Serial Device to a Bluetooth Host

Use this procedure to let the scanner communicate with a Bluetooth host using the Bluetooth Serial Port Profile (SPP).

1. If using a Bluetooth adapter on the host device, install any driver provided with the adapter.
2. Scan the Link to Host in SPP mode label below to make the scanner visible to the host device.
3. Use the Bluetooth manager of the host device to "Discover new devices" and select "GBT4200...". If you receive an error message, it may be necessary to change the security settings on either the host device or the scanner.
4. Use an RS-232 terminal program to see incoming data on the port designated by the Bluetooth manager of the host device.

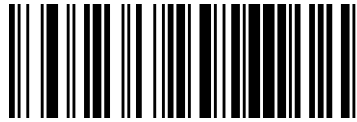

Link to Host in SPP Mode

Link Scanner as HID device to a Bluetooth host

Use this procedure to send data to a Bluetooth host using the Bluetooth HID profile.

1. If using a Bluetooth adapter on the host device, install any driver provided with the adapter.
2. Scan the Link to Host in HID mode label below to make the scanner visible to the host device.
3. Use the Bluetooth manager of the host device to "Discover new devices" and select "GBT4200 ...". If you receive an error message, it may be necessary to change the security settings on either the host device or the scanner.
4. On the host device, open the program that is meant to receive the incoming data.

The data transmitted by the scanner will appear in the program as if it was typed using the keyboard of the host device.

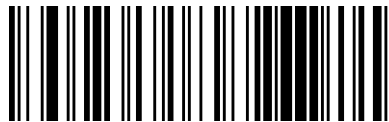

Link to Host in HID mode



NOTE: The Gryphon I GBT4200 can be set up to authenticate the remote system when connecting, by entering a Bluetooth passkey or a PIN code. If you want to set the security level and authentication options suitable for your application, or when adding new equipment to a system that requires authentication or uses a custom security PIN, please see the "Bluetooth Security Level" on page 206.

BLUETOOTH PASSKEY OR PIN CODE ENTRY REQUEST

During the pairing process, based on Host and Reader security settings, you may need to enter a Bluetooth passkey or PIN code.

When requested by the Host, simply enter the displayed code by scanning the corresponding bar codes for alphanumeric entry listed in [Appendix D](#). Complete by scanning the End label. To restart the entering of the passkey, read the Restart label.



Passkey END



Passkey Restart

POWER OFF

Scan the bar code below to shut off power to the handheld until the next trigger pull.



Power Off

INTERFACE SELECTION

Upon completing the physical connection between the scanner and its host, proceed directly to "Configuring the Interface" on page 24 for information and programming for the interface type the scanner is connected to (for example: RS-232, Keyboard Wedge, USB, etc.) and scan the appropriate bar code in that section to select your system's correct interface type.

The scanner, depending upon the model, will support one of the following sets of host interfaces:

- USB (Keyboard, COM, OEM)
- USB Composite (Keyboard + COM)
- USB HID POS
- USB Toshiba TEC
- RS-232 STD
- RS-232 WN
- RS232 OPOS
- Keyboard Wedge
- IBM46XX port 9b (a specific cable is required)
- Datalogic Magellan Scanners' specific interface



CONFIGURING THE INTERFACE

Scan the programming bar code from the following section which selects the appropriate interface type to match the system the scanner will be connected to. Next, proceed to the corresponding chapter in this manual (also listed in the table) to configure any desired settings and features associated with that interface.



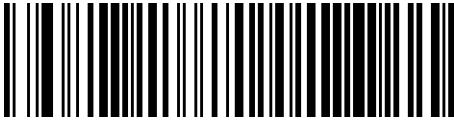

NOTE: Unlike some other programming features and options, interface selections require that you scan only one programming bar code label. DO NOT scan an ENTER/EXIT bar code prior to scanning an interface selection bar code. Some interfaces require the scanner to start in the disabled state when powered up. If additional scanner configuration is desired while in this state, pull the trigger and hold for 5 seconds. The scanner will change to a state that allows programming with bar codes.

Table 3 - Available Interfaces

RS-232	
RS-232 standard interface <i>*Not supported on USB only models</i>	 Select RS232-STD
 Select RS232-WN	RS-232 Wincor-Nixdorf
RS-232 for use with OPOS/UPOS/JavaPOS	 Select RS-232 OPOS

USB-COM ^A	
 Select USB-COM-STD	USB-COM (simulates RS-232 standard interface)
USB-Composite (combines USB-KBD emulation and USB-COM)	 Select USB-Composite

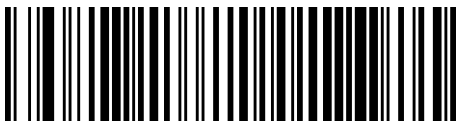
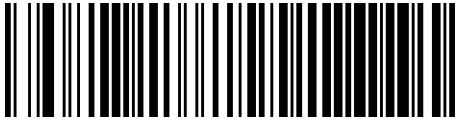
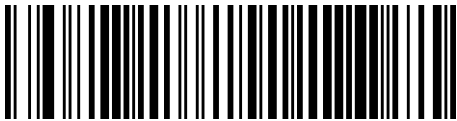





a. USB-COM driver needs to be installed for these interfaces to work. Please download it from www.datalogic.com

OTHER INTERFACES	
 <p>Select IBM-P9B</p>	<p>IBM 46xx Port 9B interface</p>
<p>USB HID POS</p>	 <p>Select USB HID POS</p>
 <p>Select USB Toshiba TEC</p>	<p>USB Toshiba TEC</p>
<p>Datalogic Magellan Scanners' specific interface, USB AUX</p>	 <p>Select Datalogic Magellan Scanners' USB AUX</p>
 <p>Magellan RS232 AUX port</p>	<p>Datalogic Magellan RS232 AUX port</p>

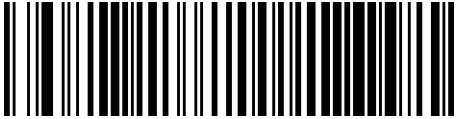
USB-OEM	
 <p>Select USB-OEM</p>	<p>USB-OEM (can be used for OPOS/UPOS/JavaPOS)</p>

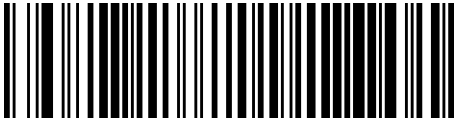

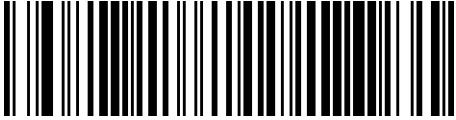
NOTE: If you erroneously read the USB-OEM interface selection code, it is required to press and hold the trigger to unlock the reader. Then read the correct interface bar code. This will work only at power-up. Please reconnect the scanner if the unlock is not successful.

KEYBOARD	
<p>AT, PS/2 25-286, 30-286, 50, 50Z, 60, 70, 80, 90 & 95 w/Standard Key Encoding</p>	 <p>Select KBD-AT</p>
 <p>Select KBD-AT-NK</p>	<p>Keyboard Wedge for IBM AT PS2 with standard key encoding but without external keyboard</p>
<p>AT, PS/2 25-286, 30-286, 50, 50Z, 60, 70, 80, 90 & 95 w/Alternate Key</p>	 <p>Select KBD-AT-ALT</p>
 <p>Select KBD-AT-ALT-NK</p>	<p>Keyboard Wedge for IBM AT PS2 with alternate key encoding but without external keyboard</p>
<p>USB Keyboard with standard key encoding</p>	 <p>Select USB Standard Keyboard</p>
 <p>Select USB Alternative Keyboard</p>	<p>USB Keyboard with alternative key encoding</p>

CUSTOMIZING CONFIGURATION SETTINGS

Using the Programming Bar Codes

This manual contains feature descriptions and bar codes which allow you to reconfigure your scanner. Some programming bar code labels, like [Resetting the Product Configuration to Defaults, starting on page 29](#), require only the scan of that single label to enact the change.

Most of the programming labels in this manual, however, require the scanner to be placed in Programming Mode prior to scanning them. Scan an ENTER/EXIT bar code once to enter Programming Mode. Once the scanner is in Programming Mode, you can scan a number of parameter settings before scanning the ENTER/EXIT bar code a second time, which will then accept your changes, exit Programming Mode and return the scanner to normal operation.



NOTE: There are some exceptions to the typical programming sequence described above. Please read the description and setting instructions carefully when configuring each given programmable feature.

Datalogic Aladdin™ Utility

Programming can alternatively be performed using the Datalogic Aladdin™ Configuration application which is available for free download from the Datalogic website listed on the back cover of this manual. This multi-platform utility program allows device configuration using a PC. It communicates to the device using a serial or USB cable and can also create configuration bar codes to print.

Datalogic Aladdin™ is a multi-platform utility program providing a quick and user-friendly configuration method via the RS-232/USB-COM interface. The Aladdin utility is available on the Datalogic website. Aladdin allows you to program the scanner by selecting configuration commands through a user-friendly graphical interface running on a PC. These commands are sent to the scanner over the selected communication interface, or they can be printed as bar codes to be scanned.

Aladdin also provides the ability to perform a software upgrade for the connected device (see the Datalogic Aladdin™ Help On-Line for more details).

Interface Settings

The scanner is typically factory-configured with a set of default features standard to the interface type you ordered. See [Appendix B, Standard Defaults](#).

Global Interface Features, starting on [page 33](#) provides settings configurable by all interface types. If your installation requires you to further customize your scanner, you can select other options through use of the instructions and programming bar codes available in the appropriate section for your interface.

- RS-232 INTERFACE on [page 34](#)
- RS-232/USB-COM INTERFACES on [page 39](#)
- RS232 OPOS on [page 39](#)
- USB Composite (COM + Keyboard) on [page 39](#)
- KEYBOARD INTERFACE on [page 47](#)
- USB-OEM INTERFACE on [page 76](#)

Configuring Other Features

If your installation requires different programming than the standard factory default settings, the following sections of this manual allow configuration of non-interface-specific settings you might require:

Configuration Using Bar Codes: General Features includes programming for scanning, speaker and LED indicators and other such universal settings.

Reading Parameters: Reading Parameters include programming for scanning, speaker and LED indicators and other universal settings.

Software Version Transmission

The software version of the device can be transmitted over the RS-232, Keyboard and USB interfaces by scanning the following label.

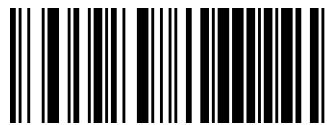

Transmit Software Version

Resetting the Product Configuration to Defaults

Restore Custom Default Configuration

If you aren't sure what programming options are in your scanner, or you've changed some options and want to restore the Custom Default Configuration that may have been saved in the scanner, scan the Restore Custom Default Configuration bar code below. This will restore the custom configuration for the currently active interface.



NOTE: Custom defaults are based on the interface type. Configure the scanner for the correct interface before scanning this label.



Restore Custom Default Configuration

Restore Factory Configuration

If you want to restore the Factory Configuration for your reader, scan either the Restore USA Factory Configuration bar code or the Restore EU Factory Configuration bar code below. Both labels restore the reader configuration to the factory settings, including the interface type. The USA label restores Label IDs to those historically used in the USA. The EU label restores Label IDs to those historically used in Europe. The Label ID sets for USA and EU are shown in the “Label ID” Section on [page 83](#) of this manual.

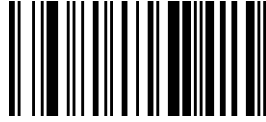

Restore USA Factory Configuration



Restore EU Factory Configuration

The programming items listed in the following sections show the factory default settings for each of the menu commands.

CHAPTER 3

CONFIGURATION WITH BAR CODES

This and following sections provide programming bar codes to configure your reader by changing the default settings. For details about additional methods of programming, see "Customizing Configuration Settings" on page 28.



NOTE: You must first enable your PowerScan to read bar codes in order to use this section. If you have not done this, go to Setup, starting on page 5 and complete the appropriate procedure.

CONFIGURATION PARAMETERS

Once the reader is set up, you can change the default parameters to meet your application needs. Refer to [Standard Defaults, starting on page 261](#) for initial configuration in order to set the default values and select the interface for your application.



NOTE: In the following sections, text shown with a green star indicates a factory default value.

★ This is an example of a default value.

The following configuration parameters are divided into logical groups, making it easy to find the desired function based on its reference group.

Interface Configuration:

- [RS-232 Standard Settings, starting on page 35](#)
- [RS-232/USB-COM Settings, starting on page 40](#)
- [Keyboard Interface, starting on page 47](#)
- [USB-OEM Interface, starting on page 76](#)

Parameters common to all interface applications:

- [Global Prefix/Suffix, starting on page 81](#)
- [Data Format, starting on page 80](#) gives options to control the messages sent to the Host system by selecting parameters to control the message strings sent to the handheld.
- [Reading Parameters, starting on page 91](#) controls various operating modes and indicators status functioning.

Symbology-specific parameters:

Symbologies, starting on page 111 defines options for all symbologies and provides the programming bar codes necessary for configuring these features.



NOTE: You must first enable your reader to read bar codes in order to use this section. If you have not done this, go to Setup, starting on page 5 and complete the appropriate procedure.

To program features:

1. Scan the ENTER/EXIT PROGRAMMING bar code, available at the top of each programming page, when applicable.
2. Scan the bar code to set the desired programming feature. You may need to cover unused bar codes on the page, and possibly the facing page, to ensure that the reader reads only the bar code you intend to scan.
3. If additional input parameters are needed, go to [Appendix D](#), and scan the appropriate characters from the keypad.



NOTE: Additional information about many features can be found in the References, starting on page 219.

If you make a mistake before the last character, scan the CANCEL bar code to abort and not save the entry string. You can then start again at the beginning.

4. Complete the programming sequence by scanning the ENTER/EXIT PROGRAMMING bar code to exit Programming Mode.

For more detailed descriptions, programming information and examples for setting selected configuration items, see [References, starting on page 219](#).

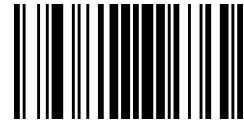

GLOBAL INTERFACE FEATURES

The following interface features are configurable by all interface types.

To set features specific to your interface, turn to that section of this manual.

Host Commands — Obey/Ignore

This option specifies whether the reader will obey or ignore host commands. When set to ignore, the reader will ignore all host commands except those necessary for:

- service mode
- flash programming mode
- keeping the interface active
- transmission of labels.

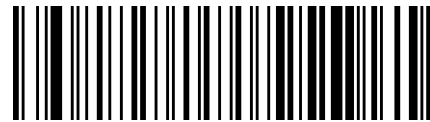

★ Host Commands = Obey
(Do Not Ignore Host Commands)

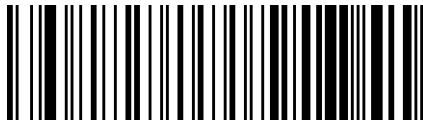

Host Commands = Ignore

USB Suspend Mode

This setting enables/disables the ability of USB interfaces to enter suspend mode.



★ USB Suspend Mode = Disable



USB Suspend Mode = Enable

CONFIGURATION | RS-232 INTERFACE

Use the programming bar codes in this chapter if modifications to the standard RS-232 interface settings are necessary to meet your system's requirements. Additional settings which apply to both the RS-232 and USB interfaces are available in [RS-232/USB-COM Settings](#), starting on page 40.

SECTION CONTENTS

RS-232 STANDARD SETTINGS starting on page 35

- | | |
|--|--|
| <ul style="list-style-type: none">•Baud Rate•Data Bits•Stop Bits | <ul style="list-style-type: none">•Parity•Handshaking Control |
|--|--|

Standard Factory Settings

Reference [Appendix B](#), for a listing of standard factory settings.

RS-232 STANDARD SETTINGS

Baud Rate

Baud rate is the number of bits of data transmitted per second. Set the scanner's baud rate to match the baud rate setting of the host device. With an improper baud rate setting, data may not reach the host correctly.

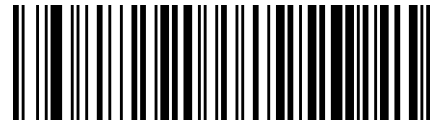

Baud Rate = 1200



Baud Rate = 2400



Baud Rate = 4800

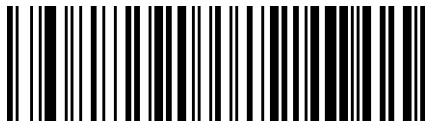

★ Baud Rate = 9600



Baud Rate = 19,200



Baud Rate = 38,400



Baud Rate = 57,600



Baud Rate = 115,200

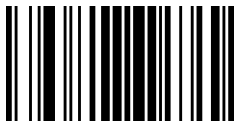

Data Bits

This parameter allows the reader to interface with devices requiring a 7-bit or 8-bit ASCII protocol for sending and receiving data.



7 Data Bits

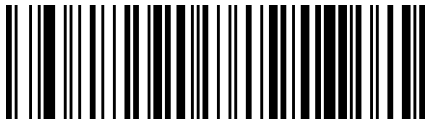

★ 8 Data Bits



NOTE: Handheld and Cradle models support the 8-bit ASCII protocol. The 7-bit ASCII protocol support is subject to specific firmware release. If the setting is not supported, the scanner will emit three short beeps upon scanning the label.

Stop Bits

The stop bit(s) at the end of each transmitted character marks the end of transmission of one character and prepares the receiving device for the next character in the serial data stream. The number of stop bits selected (one or two) depends on the number the receiving terminal is programmed to accommodate. Set the number of stop bits to match host device requirements..



★ 1 Stop Bit



2 Stop Bits

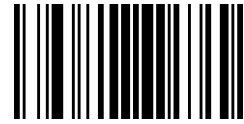

Parity

This feature specifies parity required for sending and receiving data. A parity check bit is the most significant bit of each ASCII coded character. Select the parity type according to host device requirements.

- Select None when no parity bit is required.
- Select Odd parity and the parity bit value is set to 0 or 1, based on data, to ensure that an odd number of 1 bits are contained in the coded character.
- Select Even parity and the parity bit value is set to 0 or 1, based on data, to ensure that an even number of 1 bits are contained in the coded character.

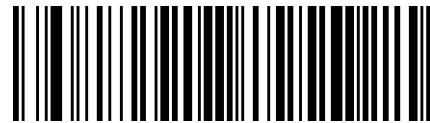

★ Parity = None

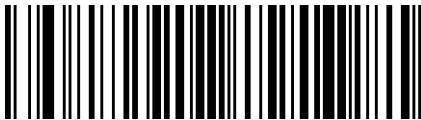

Parity = Even

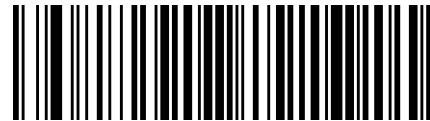

Parity = Odd



Handshaking Control

The data interface consists of an RS-232 port designed to operate either with or without the hardware handshaking lines, Request to Send (RTS), and Clear to Send (CTS). Handshaking Control includes the following options:

- RTS — RTS is asserted during transmissions. CTS is ignored.
- RTS/CTS — RTS is asserted during transmissions. CTS gates transmissions.
- RTS/XON/XOFF — RTS is asserted during transmissions. CTS is ignored. XON and XOFF gate transmissions.
- RTS On/CTS — RTS is always asserted. CTS gates transmissions.
- RTS/CTS Scan Control — RTS is asserted during transmissions. CTS gates transmissions and controls enable and disable state of scanner.



★ Handshaking Control = RTS



Handshaking Control = RTS/CTS



Handshaking Control = RTS/XON/XOFF



Handshaking Control = RTS On/CTS



Handshaking Control = RTS/CTS Scan Control

CONFIGURATION | RS-232/USB-COM INTERFACES

SECTION CONTENTS	
<ul style="list-style-type: none">•Intercharacter Delay•Beep On ASCII BEL•Beep On Not on File•ACK NAK Options•ACK Character•NAK Character	<ul style="list-style-type: none">•ACK NAK Timeout Value•ACK NAK Retry Count•ACK NAK Error Handling•Indicate Transmission Failure•Disable Character•Enable Character

Standard Factory Settings

Reference [Appendix B](#), for a listing of standard factory settings.



RS-232/USB-COM SETTINGS

Intercharacter Delay

This parameter specifies the intercharacter delay between the end of one character and the beginning of the next. The delay can be set within a range of zero (0) to 990 milliseconds in 10ms increments. A setting of zero specifies no delay. See "Intercharacter Delay" on page 221 for more detailed programming instructions.



Intercharacter Delay = No Delay

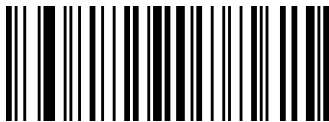

Select Intercharacter Delay Setting

To configure this feature, scan the ENTER/EXIT bar code above, then the bar code at left followed by digits from the Alphanumeric characters in [Appendix D](#) representing your desired character(s). End by scanning the ENTER/EXIT bar code again.

Make a mistake? Scan the CANCEL bar code to abort and not save the entry string. You can then start again at the beginning.

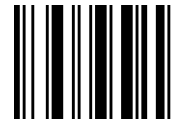

CANCEL

★00 = No Intercharacter Delay

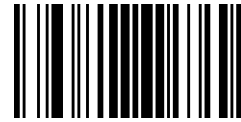

Beep On ASCII BEL

When this parameter is enabled, the scanner issues a beep when a <BEL> character is detected on the RS-232 serial line. <BEL> is issued to gain a user's attention to an illegal entry or other important event.

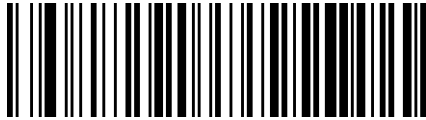

★ Beep On ASCII BEL = Disable



Beep On ASCII BEL = Enable

Beep On Not on File

This option enables/disables the action of the scanner to sound a three beep sequence upon receiving a Not-On-File (NOF) host command.



Beep On Not On File = Disable



★ Beep On Not On File = Enable



ACK NAK Options

This enables/disables the ability of the scanner to support the RS-232 ACK/NAK protocol. When configured, the scanner and/or host sends an “ACK” when it receives data properly, and sends “NAK” when the data is in error.

Options are:

- Disable
- Enable for label transmission — The scanner expects an ACK/NAK response from the host when a label is sent.
- Enable for host-command acknowledge — The scanner will respond with ACK/NAK when the host sends a command.
- Enable for label transmission and host-command acknowledge



★ ACK/NAK Protocol = Disable ACK/NAK



ACK/NAK Protocol = Enable for label transmission



ACK/NAK Protocol = Enable for host-command
acknowledge



ACK/NAK Protocol = Enable for label transmission and
host command acknowledge

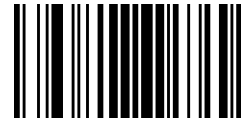

ACK Character

This setting specifies an ASCII character or hex value to be used as the ACK character. ASCII characters or any hex value from 0 to 0xFF can be selected. See "ACK Character" on page 222 for more detailed programming instructions.



NOTE: Setting to previously defined characters such as XON, XOFF, or host commands conflicts with normal operation of these characters. 8-bit data is not recognized when the option "Data Bits" on page 36 has been set as 7 Data Bits.



Select ACK Character Setting

Make a mistake? Scan the CANCEL bar code to abort and not save the entry string. You can then start again at the beginning.

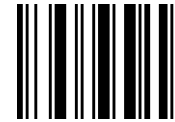

CANCEL

★ 0x06 'ACK' Character

NAK Character

This setting specifies an ASCII character or hex value to be used as the NAK character. ASCII characters or any hex value from 0 to 0xFF can be selected. See "NAK Character" on page 223 for more detailed programming instructions.



NOTE: Setting to previously defined characters such as XON, XOFF, or host commands conflicts with normal operation of these characters. 8-bit data is not recognized when the option "Data Bits" on page 36 has been set as 7 Data Bits.



Select NAK Character Setting

Make a mistake? Scan the CANCEL bar code to abort and not save the entry string. You can then start again at the beginning.



CANCEL

★ 0x15 'NAK' Character



ACK NAK Timeout Value

This option specifies the amount of time the scanner waits for an ACK character from the host following label transmission. The selectable timeout range is 200 milliseconds to 15,000ms (15 seconds) in 200ms increments. A selection of 0 disables the timeout. See "[ACK NAK Timeout Value](#)" on page 224 for more detailed programming instructions.



Select ACK NAK Timeout Value Setting

To configure this feature, scan the ENTER/EXIT bar code above, then the bar code at left followed by digits from the Alphanumeric characters in [Appendix D](#) representing your desired character(s). End by scanning the ENTER/EXIT bar code again.

Make a mistake? Scan the CANCEL bar code to abort and not save the entry string. You can then start again at the beginning.

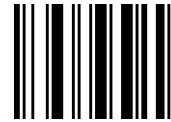

CANCEL

★01 ACK NAK Timeout value is 200ms

ACK NAK Retry Count

This feature specifies the number of times the scanner retries a label transmission due to a retry condition. The selectable range is from 1 to 254 retries. A selection of 0 disables the count, and a selection of 255 specifies unlimited retries. See "[ACK NAK Retry Count](#)" on page 225 for more detailed programming instructions.

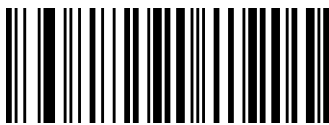

Select ACK NAK Retry Count Setting

To configure this feature, scan the ENTER/EXIT bar code above, then the bar code at left followed by digits from the Alphanumeric characters in [Appendix D](#) representing your desired character(s). End by scanning the ENTER/EXIT bar code again.

Make a mistake? Scan the CANCEL bar code to abort and not save the entry string. You can then start again at the beginning.



CANCEL

★003 = 3 Retries

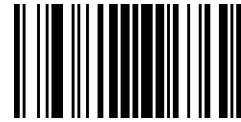

ACK NAK Error Handling

This feature specifies the method the scanner uses to handle receive errors detected while waiting for an ACK character from the host.

Options are:

- Ignore errors detected
- Process error as valid ACK character
- Process error as valid NAK character

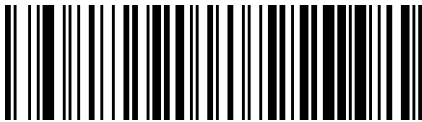

★ ACK NAK Error Handling = Ignore Errors Detected

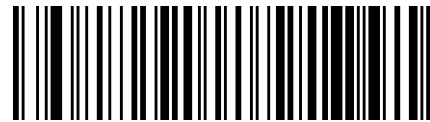

ACK NAK Error Handling = Process Error as Valid ACK Character

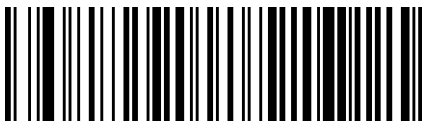

ACK NAK Error Handling = Process Error as Valid NAK Character

Indicate Transmission Failure

This option enables/disables the scanner's ability to sound an error beep to indicate a transmission failure while in ACK/NAK mode.

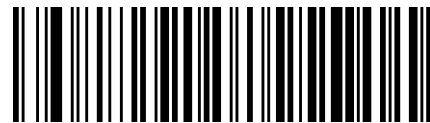

Indicate Transmission Failure = Disable Indication

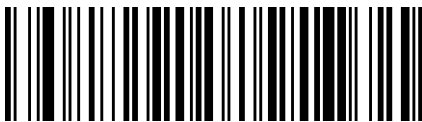

★ Indicate Transmission Failure = Enable Indication



Disable Character

Specifies the value of the RS-232 host command used to disable the scanner. ASCII characters or any hex value from 0 to 0xFF can be selected. See "Disable Character" on page 226 for more detailed programming instructions.



Setting to previously defined characters such as XON, XOFF, or host commands conflicts with normal operation of these characters.

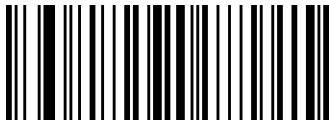

Select Disable Character Setting

Make a mistake? Scan the CANCEL bar code to abort and not save the entry string. You can then start again at the beginning.

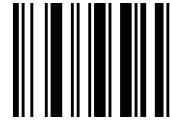

CANCEL

★ 0x44 = Disable Character is 'D'

Enable Character

Specifies the value of the RS-232 host command used to enable the scanner. ASCII characters or any hex value from 0 to 0xFF can be selected. See "Enable Character" on page 227 for more detailed programming instructions



Setting to previously defined characters such as XON, XOFF, or host commands conflicts with normal operation of these characters.

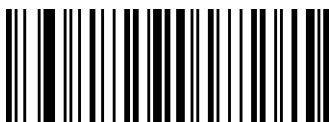

Select Enable Character Setting

Make a mistake? Scan the CANCEL bar code to abort and not save the entry string. You can then start again at the beginning.



CANCEL

★ 0x45 = Enable Character is 'E'

CONFIGURATION | KEYBOARD INTERFACE

SECTION CONTENTS	
COUNTRY MODE starting on page 48	
•Setting Country Mode	
OTHER KEYBOARD PARAMETERS starting on page 63	
<ul style="list-style-type: none"> •Encoding Type •ALT Output Type •Caps Lock State •Numlock •Keyboard Numeric Keypad 	<ul style="list-style-type: none"> •Keyboard Send Control Characters •Wedge Quiet Interval •Intercharacter Delay •Intercode Delay •USB Keyboard Speed

Use the programming bar codes in this chapter to select options for USB Keyboard and Wedge Interfaces. Reference [Appendix B](#), for a listing of standard factory settings. Information about control character emulation which applies to keyboard interfaces is listed in [Appendix E](#), Scancode Tables.

COUNTRY MODE

This feature specifies the country/language supported by the keyboard.

The Country Mode setting is ignored if the interface uses alternate key encoding.

SETUP ON PC TO USE ALT UNIVERSAL

1. Open Registry Edit

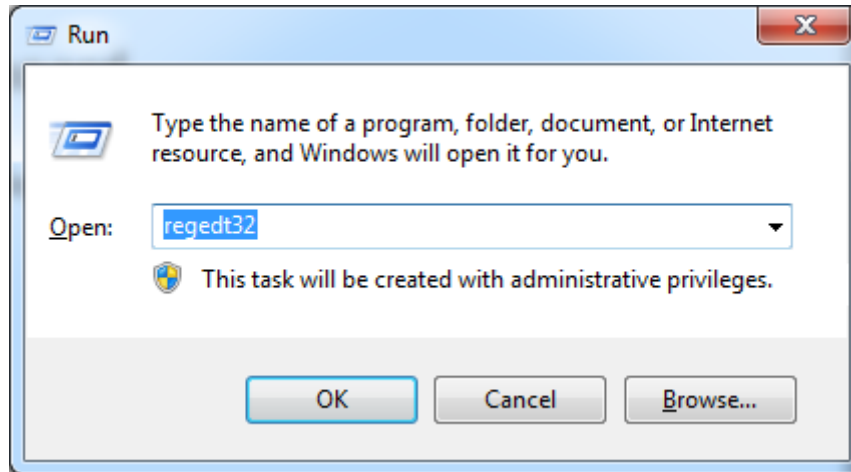

2. Set EnableHexNumpad to 1 as follows:

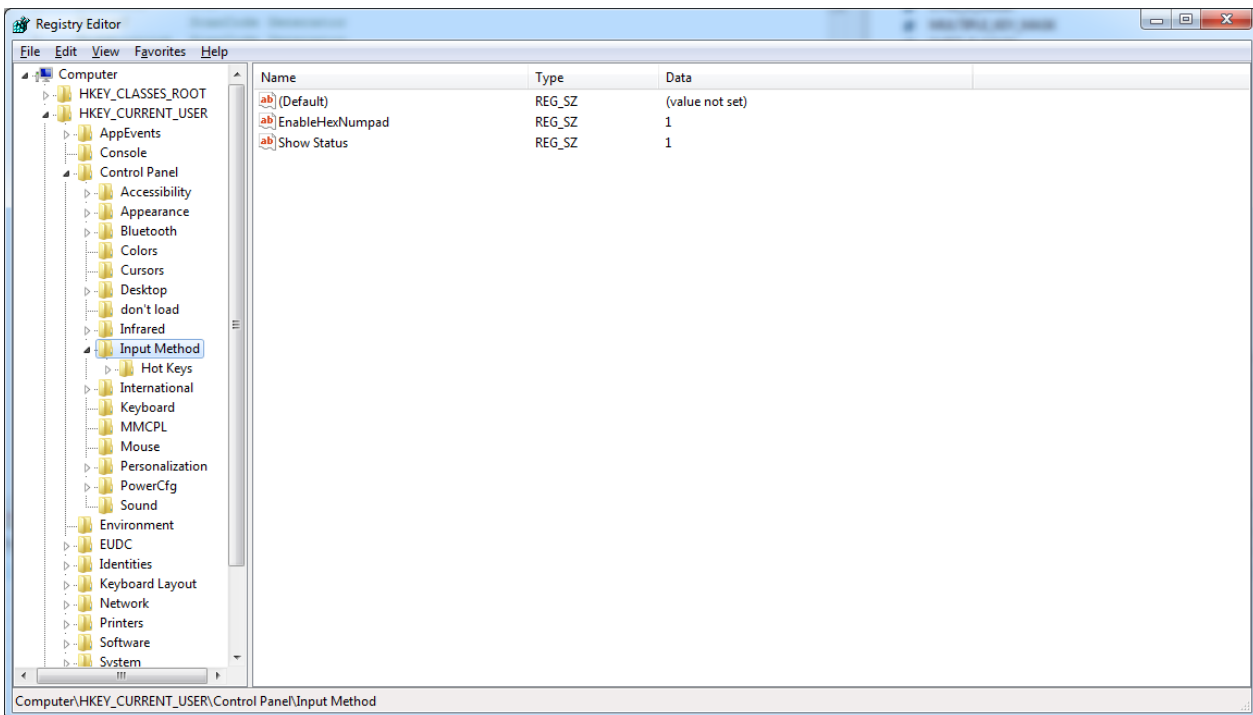

3. Reset the PC.

Setting Country Mode

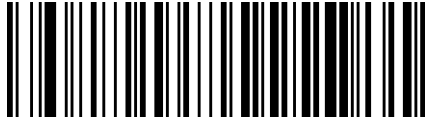

★ United States



French International (Belgian French)

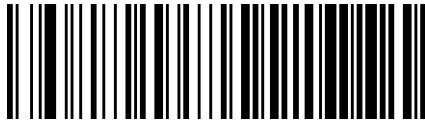

United Kingdom



Danish

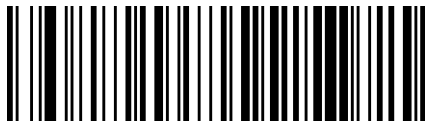

French (France)



German

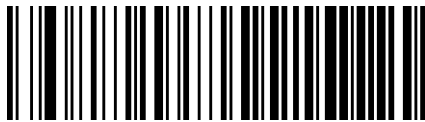

Italian



Setting Country Mode (continued)



Norwegian



Portuguese (Portugal)

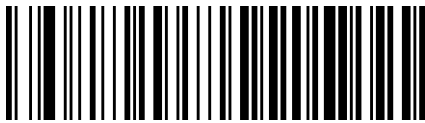

Spanish



Swedish

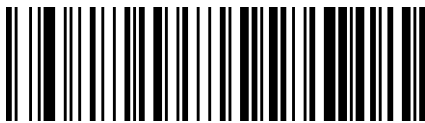

Swiss French



Japanese ASCII



Hungarian

Setting Country Mode (continued)



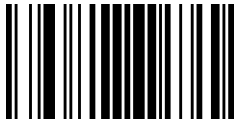

Setting Country Mode (continued)



Vietnamese



Russian

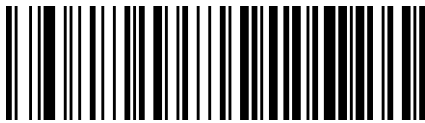

Arabic 101



Chinese ASCII

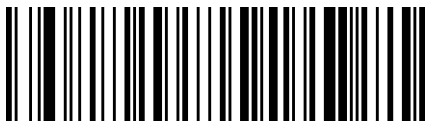

Thai-Kedmanee



Albanian



Arabic 102

Setting Country Mode (continued)



Arabic 102 AZERTY



Azeri Cyrillic



Azeri Latin



Belarusian



Bosnian Cyrillic



Bosnian Latin



Bulgarian Cyrillic



Setting Country Mode (continued)

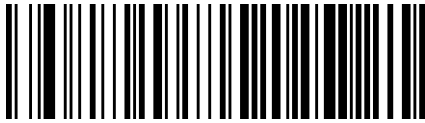

Bulgarian Latin



Canadian French (Legacy)

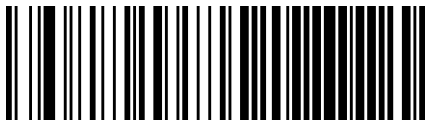

Canadian Multilingual



Chinese (Simplified)

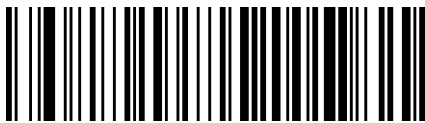

Chinese (Traditional)



Czech Programmers



Czech QWERTY

Setting Country Mode (continued)





Setting Country Mode (continued)



Greek



Greek Latin



Greek Polytonic



Greek220



Greek220 Latin

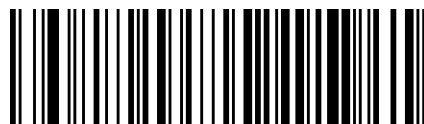

Greek319



Greek319 Latin

Setting Country Mode (continued)



Hebrew Israel



Hungarian_101KEY



Icelandic



Irish



Italian_142



Japanese (Shift-JIS)



Kazakh



Setting Country Mode (continued)



Korean (Hangul)



Korean ASCII



Kyrgyz Cyrillic



Latin America

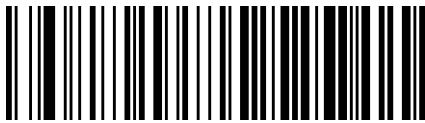

Latvian



Latvian QWERTY

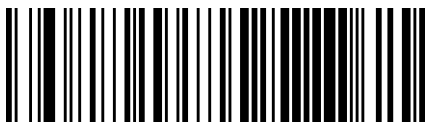

Lithuanian_IBM

Setting Country Mode (continued)



Macedonian -FYROM



Maltese_47KEY



Mongolian-Cyrillic

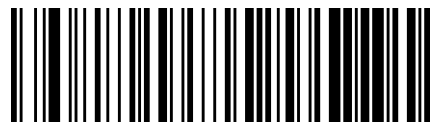

Polish Programmer



Portuguese Brazil



Portuguese Brazilian ABNT



Portuguese Brazilian ABNT2

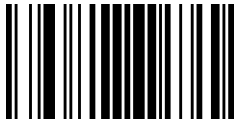

Setting Country Mode (continued)



Romanian Legacy

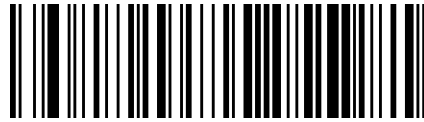

Romanian Programmer



Romanian Standard



Russian Typewriter



Serbian Cyrillic

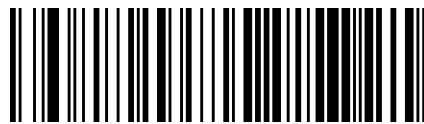

Serbian Latin



Slovak QWERTY

Setting Country Mode (continued)



Slovenian



Spanish Variation



Swiss German



Tatar

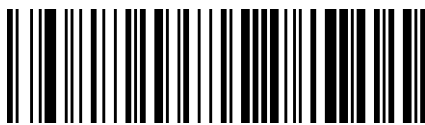

Turkish F



Turkish Q

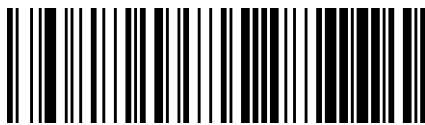

Ukrainian



Setting Country Mode (continued)

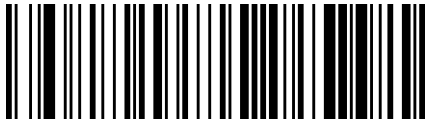

US Dvorak



US Dvorak Left Hand

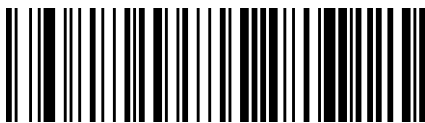

US Dvorak Right Hand



US English (Mac)

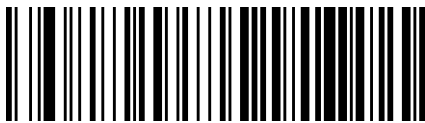

US English (North American)



US International



Uzbek Cyrillic

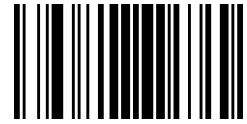

OTHER KEYBOARD PARAMETERS

Encoding Type



Encoding Type = Don't Use Encoding



Encoding Type = UTF_8

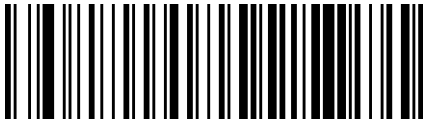

Encoding Type = Windows 874



Encoding Type = Windows 932



Encoding Type = Windows 936



Encoding Type = Windows 949

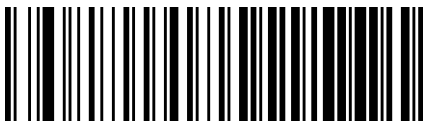

Encoding Type = Windows 950



Encoding Type (continued)



Encoding Type = Windows 1250

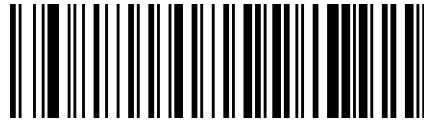

Encoding Type = Windows 1251

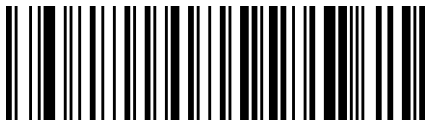

Encoding Type = Windows 1252

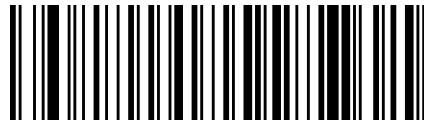

Encoding Type = Windows 1253

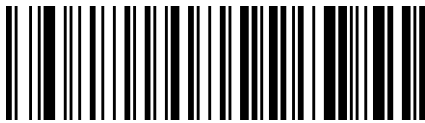

Encoding Type = Windows 1254



Encoding Type = Windows 1255



Encoding Type = Windows 1256

Encoding Type (continued)

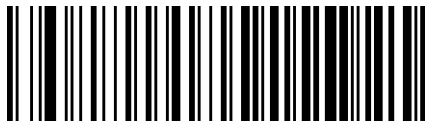

Encoding Type = Windows 1257



Encoding Type = Windows 1258



Encoding Type = Windows 20866

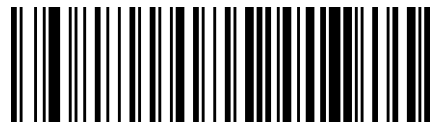

Encoding Type = Windows 54936



Encoding Type = ISO 8859-1



Encoding Type = ISO 8859-2



Encoding Type = ISO 8859-3



Encoding Type (continued)



Encoding Type = ISO 8859-4

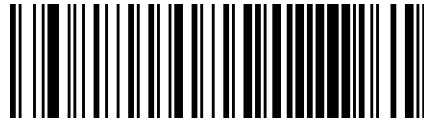

Encoding Type = ISO 8859-5



Encoding Type = ISO 8859-6

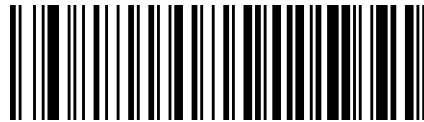

Encoding Type = ISO 8859-7

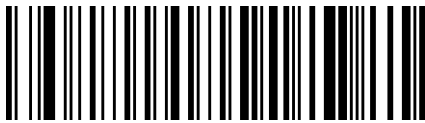

Encoding Type = ISO 8859-8



Encoding Type = ISO 8859-9



Encoding Type = ISO 8859-10

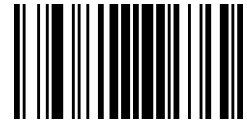

Encoding Type (continued)



Encoding Type = ISO 8859-11

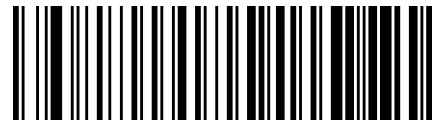

Encoding Type = ISO 8859-13



Encoding Type = ISO 8859-14

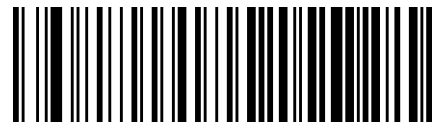

Encoding Type = ISO 8859-15



Encoding Type = ISO 8859-16



Encoding Type = MS-DOS 437



Encoding Type = MS-DOS 737

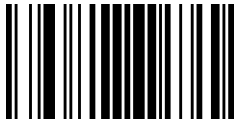

Encoding Type (continued)



Encoding Type = MS-DOS 775



Encoding Type = MS-DOS 850



Encoding Type = MS-DOS 852

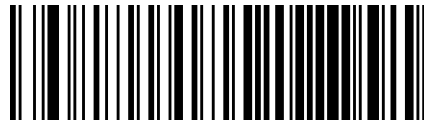

Encoding Type = MS-DOS 855



Encoding Type = MS-DOS 857



Encoding Type = MS-DOS 860



Encoding Type = MS-DOS 861

Encoding Type (continued)



Encoding Type = MS-DOS 862

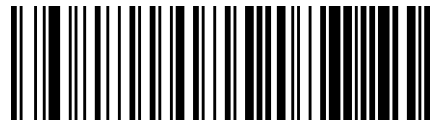

Encoding Type = MS-DOS 863



Encoding Type = MS-DOS 865

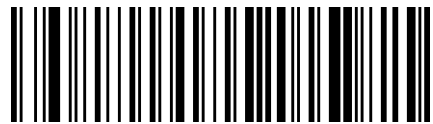

Encoding Type = MS-DOS 866



Encoding Type = MS-DOS 869

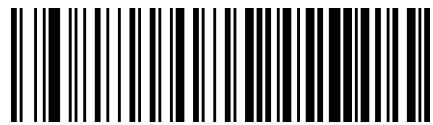

Encoding Type = Mac CP10000



ALT Output Type

This option specifies the encode type of ALT Mode when the scanner sends Output Keyboard Data in Alt Mode. (Be aware that the scanner may switch automatically between ALT mode & Normal Keyboard Scancode, to correctly display some characters that are not present in the current Keyboard Country).

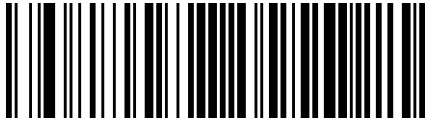

ALT Output Type = ALT Codepage
(use on non Unicode application: Notepad)



★ ALT Output Type = ALT Unicode
(use on Unicode application: Word)

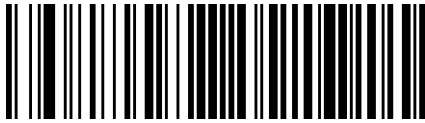

ALT Output Type = ALT Universal
(Use for all)

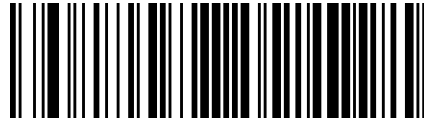

ALT Output Type = ALT Unicode for Linux

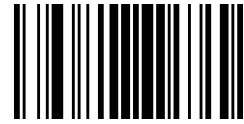

Caps Lock State

This option specifies the format in which the scanner sends character data. This applies to Keyboard Wedge interfaces. This does not apply when an alternate key encoding keyboard is selected. This does not apply to USB Keyboard.

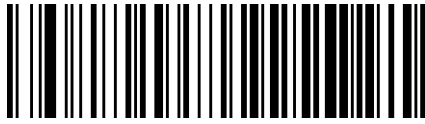

★ Caps Lock State = Caps Lock OFF



Caps Lock State = Caps Lock ON

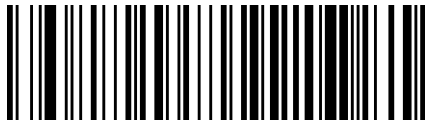

Caps Lock State = AUTO Caps Lock Enable

Numlock

This option specifies the setting of the Numbers Lock (Numlock) key while in Keyboard Wedge interface. This only applies to alternate key encoding interfaces. It does not apply to USB Keyboard.

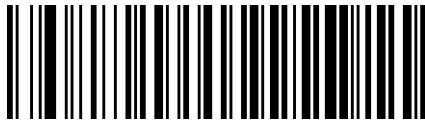

★ Numlock = Numlock key unchanged



Numlock = Numlock key toggled



Keyboard Numeric Keypad

This feature specifies if numeric characters will be sent using the standard keys or the numeric keypad.



★ Keyboard Numeric Keypad = Standard Keys



Keyboard Numeric Keypad = Numeric Keypad

Keyboard Send Control Characters

This feature is used by the Keyboard Wedge and USB Keyboard interfaces. It specifies how the scanner transmits ASCII control characters to the host. Reference [Appendix E Scancode Tables](#) for more information about control characters.

Options are as follows:

Send Ctrl+Key : ASCII characters from 00H to 0x1FH inclusive are transmitted in the format Ctrl+Key. Special keys are available in the range from 81H to A1.

Send Ctrl+Shift+Key : The behavior is the same as above, but control keys are sent in the format Ctrl+Shift+Keys.

Send Special Function Key : Send characters between 00H and 1FH according to the special function key mapping table (see "[Interface Type PC AT PS/2 Alt Mode or USB-Keyboard Alt Mode](#)" on page 280). This is used to send keys that are not in the normal ASCII set. A unique set is provided for each available scancode set.



★ Keyboard Send Control Characters = Send Ctrl+Key



Keyboard Send Control Characters = Send Ctrl+Shift+Key



Keyboard Send Control Characters = Send Special Function Key

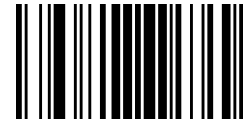

Wedge Quiet Interval

This option specifies the amount of time to look for keyboard activity before the scanner breaks the keyboard connection in order to transmit data to host. The selectable range for this feature is from 0 to 990ms in 10ms increments. See "[Wedge Quiet Interval](#)" on page 228 for more detailed programming instructions.



NOTE: This feature applies ONLY to the Keyboard Wedge interface.



Select Wedge Quiet Interval Setting

To configure this feature, scan the ENTER/EXIT bar code above, then the bar code at left followed by digits from the Alphanumeric characters in [Appendix D](#), Keypad representing your desired character(s). End by scanning the ENTER/EXIT bar code again.

Make a mistake? Scan the CANCEL bar code to abort and not save the entry string. You can then start again at the beginning.



CANCEL

★10 = Quiet Interval of 100 ms

Intercharacter Delay

This parameter specifies the intercharacter delay between the end of one character and the beginning of the next. The delay can be set within a range of zero (0) to 990 milliseconds in 10ms increments. A setting of zero specifies no delay. See "[Intercharacter Delay](#)" on page 229 for more detailed programming instructions.



Intercharacter Delay = No Delay



Select Intercharacter Delay Setting

To configure this feature, scan the ENTER/EXIT bar code above, then the bar code at left followed by digits from the Alphanumeric characters in [Appendix D](#), Keypad representing your desired character(s). End by scanning the ENTER/EXIT bar code again.

Make a mistake? Scan the CANCEL bar code to abort and not save the entry string. You can then start again at the beginning.



CANCEL

★00 = No Intercharacter Delay



Intercode Delay

Specifies the delay between labels transmitted to the host for this interface. The selectable range for this feature is from 0 to 99 seconds. See "[Intercode Delay](#)" on page 230 for more detailed programming instructions



Set Intercode Delay

To configure this feature, scan the ENTER/EXIT PROGRAMMING MODE bar code above, then the bar code at left followed by the digits from the Alphanumeric characters in [Appendix D, Keypad](#) representing your desired character(s). End by scanning the ENTER/EXIT bar code again.

Make a mistake? Scan the CANCEL bar code to abort and not save the entry string. You can then start again at the beginning.



CANCEL

★00 = No Wedge Intercode Delay

USB Keyboard Speed

This option specifies the USB poll rate for a USB Keyboard.



NOTE: This feature applies ONLY to the USB Keyboard interface.

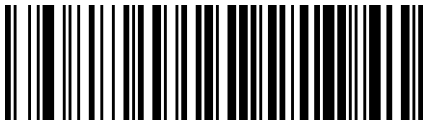

★ USB Keyboard Speed = 1ms



USB Keyboard Speed = 2ms

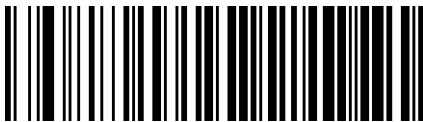

USB Keyboard Speed = 3ms



USB Keyboard Speed = 5ms



USB Keyboard Speed = 7ms



USB Keyboard Speed = 10ms

CONFIGURATION | USB-OEM INTERFACE

SECTION CONTENTS	
•USB-OEM Device Usage	•USB-OEM Interface Options



USB-OEM Device Usage

The USB-OEM protocol allows for the scanner to be identified as one of two different types of bar code scanners. Depending on what other scanners you may already have connected to a USB-OEM POS, you may need to change this setting to enable all devices to communicate.

Options are:

- Tabletop Scanner
- Handheld Scanner



NOTE: This feature is not compatible with Multiple Labels Reading in a Volume.

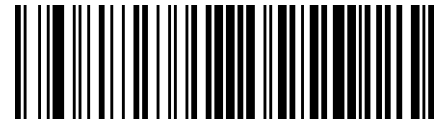

USB-OEM Device Usage = Tabletop Scanner

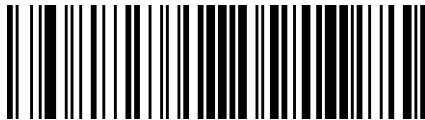

★ USB-OEM Device Usage = Handheld Scanner

USB-OEM Interface Options

This setting provides for an interface specific control mechanism.

Options are:

- Obey — Obey Scanner Configuration Host Commands
- Ignore — Ignore Scanner Configuration Host Commands



★ Interface Options = Obey Scanner Configuration Host Commands



Interface Options = Ignore Scanner Configuration Host Commands

CONFIGURATION | IBM 46XX INTERFACE

SECTION CONTENTS

SECTION CONTENTS	
•IBM 46xx Interface Options	

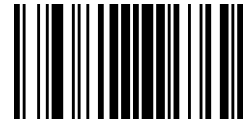

IBM 46xx Interface Options

This setting provides for an interface specific control mechanism.

Options are:

- Obey — Obey Scanner Configuration Host Commands
- Ignore — Ignore Scanner Configuration Host Commands

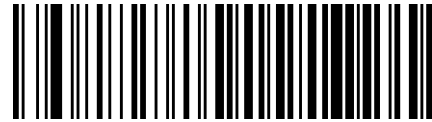

★ Interface Options = Obey Scanner Configuration
Host Commands



Interface Options = Ignore Scanner Configuration
Host Commands

CONFIGURATION | DATA FORMAT

SECTION CONTENTS	
<ul style="list-style-type: none">•Global Prefix/Suffix•Global AIM ID	<ul style="list-style-type: none">•GS1-128 AIM ID
LABEL ID starting on page 83	
<ul style="list-style-type: none">•Label ID: Pre-loaded Sets•Label ID: Set Individually Per Symbology	<ul style="list-style-type: none">•Label ID Control•Label ID Symbology Selection
<ul style="list-style-type: none">•Case Conversion	<ul style="list-style-type: none">•Character Conversion

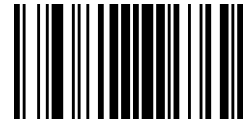

Global Prefix/Suffix

Up to 20 ASCII characters may be added as a prefix (in a position before the bar code data) and/or as a suffix (in a position following the bar code data). See "Global Prefix/Suffix" on page 232 for more detailed programming instructions.

To configure this feature, scan the ENTER/EXIT PROGRAMMING MODE bar code above, then the bar code at right followed by the digits from the Alphanumeric characters in [Appendix D, Keypad](#) representing your desired character(s). End by scanning the ENTER/EXIT bar code again.

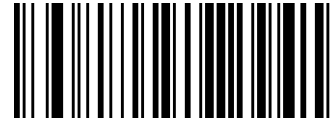

Set Global Prefix

To configure this feature, scan the ENTER/EXIT PROGRAMMING MODE bar code above, then the bar code at left followed by the digits from the Alphanumeric characters in [Appendix D, Keypad](#) representing your desired character(s). End by scanning the ENTER/EXIT bar code again.



Set Global Suffix

Make a mistake? Scan the CANCEL bar code to abort and not save the entry string. You can then start again at the beginning.



CANCEL

★ No Global Prefix

★ Global Suffix = 0x0D(CR)



Global AIM ID



NOTE: This feature enables/disables addition of AIM IDs for all symbology types.

AIM label identifiers (as opposed to custom characters you select yourself as with label identifiers) can be included with scanned bar code data. See "Global AIM ID" on page 233 for more detailed programming instructions.

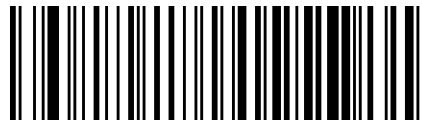

★ Global AIM ID = Disable

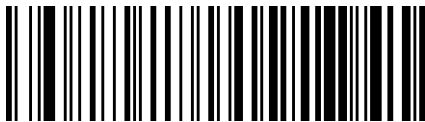

Global AIM ID = Enable

GS1-128 AIM ID

If Global AIM ID is disabled, the AIM ID for GS1-128 can be enabled/disabled independently. The AIM ID for GS1-128 is a]C1,]C2.

AIM IDs for other symbologies can be enabled/disabled independently as well. Contact Customer Support for assistance.



★ GS1-128 AIM ID = Disable

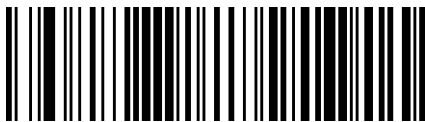

GS1-128 AIM ID = Enable

LABEL ID

A Label ID is a customizable code of up to three ASCII characters (each can be one of hex 0x01-0xFF), used to identify a bar code (symbology) type. It can be appended previous to or following the transmitted bar code data depending upon how this option is enabled. This feature provides options for configuring custom Label IDs as a pre-loaded set (see "Label ID: Pre-loaded Sets" below) or individually per symbology (see "[Label ID: Set Individually Per Symbology](#)" on page 84). If you wish to program the scanner to always include an industry standard label identifier for ALL symbology types, see the previous feature "[Global AIM ID](#)" on page 82.

Label ID: Pre-loaded Sets

The scanner supports two pre-loaded sets of Label IDs, the USA set and the EU set. See "[Label ID: Pre-loaded Sets](#)" on page 234 for more information concerning the pre-loaded sets that are provided.



CAUTION: When changing from one Label ID set to another, all other scanner configuration settings, including the host interface type, will be erased and set to the factory defaults. Any custom configuration or custom defaults will be lost.



★ Label ID Pre-loaded Set = USA Set



Label ID Pre-loaded Set = EU Set

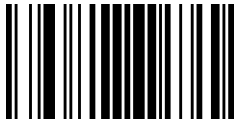

Label ID: Set Individually Per Symbology

This feature configures a Label ID individually for a single symbology.



NOTE: This setting requires the scanning of bar codes from multiple sections. See "Label ID: Set Individually Per Symbology" on page 236 for more detailed programming instructions.

Label ID Control

This option controls whether a Label ID is disabled, or sent as a prefix or suffix for a given symbology type.



★ Label ID Transmission = Disable



Label ID Transmission = Enable as Prefix



Label ID Transmission = Enable as Suffix

Label ID Symbology Selection

This option selects the symbology for which a Label ID is to be configured. See "[Label ID: Set Individually Per Symbology](#)" on page 236 for full instructions.

Make a mistake? Scan the CANCEL bar code to abort and not save the entry string. You can then start again at the beginning.

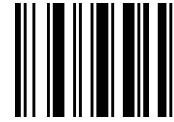

CANCEL



Set UPC-A Label ID Character(s)



Set UPC-A/P2 Label ID Character(s)



Set UPC-A/P5 Label ID Character(s)



Set UPC-E Label ID Character(s)



Set UPC-E/P2 Label ID Character(s)



Set UPC-E/P5 Label ID Character(s)



Set EAN-13 Label ID Character(s)



Label ID Symbology Selection (continued)



Set EAN-13/P2 Label ID Character(s)



Set EAN-13/P5 Label ID Character(s)



Set ISBN Label ID Character(s)

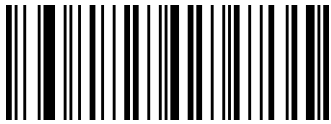

Set ISSN Label ID Character(s)



Set EAN-8 Label ID Character(s)



Set EAN-8/P2 Label ID Character(s)



Set EAN-8/P5 Label ID Character(s)



Set GS1 DataBar Omnidirectional Label ID Character(s)

Label ID Symbology Selection (continued)



Set GS1 DataBar Expanded Label ID Character(s)



Set GS1 DataBar Limited Label ID Character(s)



Set Code 39 Label ID Character(s)



Set Code 32 Label ID Character(s)



Set Code 39 CIP Label ID Character(s)



Set Code 128 Label ID Character(s)



Set Code GS1-128 Label ID Character(s)

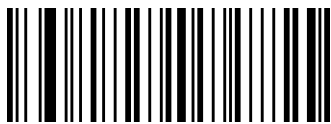

Set Interleaved 2 of 5 Label ID Character(s)



Label ID Symbology Selection (continued)



Set Interleaved 2 of 5 CIP HR Label ID Character(s)



Datalogic 2 of 5 Label ID Character(s)



Standard 2 of 5 Label ID Character(s)



Industrial 2 of 5 Label ID Character(s)

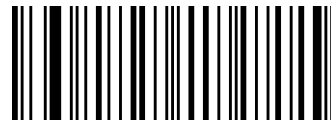

IATA Label ID Character(s)



Codabar Label ID Character(s)



ABC Codabar Label ID Character(s)



ISBT 128 Label ID Character(s)
(single and concatenated)

Label ID Symbology Selection (continued)



Code 11 Label ID Character(s)



MSI Label ID Character(s)



Plessey Label ID Character(s)

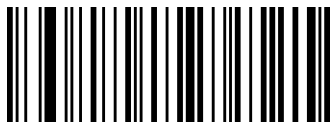

Anker Plessey Label ID Character(s)



Case Conversion

This feature allows conversion of the case of all alphabetic characters to upper or lower case.



NOTE: Case conversion affects ONLY scanned bar code data, and does not affect Label ID, Prefix, Suffix, or other appended data.

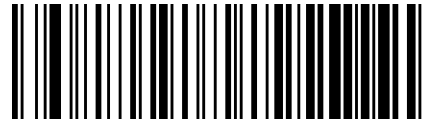

★ Case Conversion = Disable (no case conversion)



Case Conversion = Convert to upper case



Case Conversion = Convert to lower case

Character Conversion

Character conversion is an eight byte configuration item. The eight bytes are 4 character pairs represented in hexadecimal ASCII values. The first character in the pair is the character that will be converted. The second character in the pair is the character to convert to. If the character to convert in a pair is FF, then no conversion is done. See "[Character Conversion](#)" on page 238 for more detailed programming instructions.



Configure Character Conversion

To configure this feature, scan the ENTER/EXIT PROGRAMMING MODE bar code above, then the bar code at left followed by the digits from the Alphanumeric characters in [Appendix D, Keypad](#) representing your desired character(s). End by scanning the ENTER/EXIT bar code again.

Make a mistake? Scan the CANCEL bar code to abort and not save the entry string. You can then start again at the beginning.



CANCEL

★ 0xFFFFFFFFFFFFFFFF
(no character conversion)

CONFIGURATION | READING PARAMETERS

SECTION CONTENTS	
SCANNING FEATURES starting on page 92	
<ul style="list-style-type: none"> •Scan Mode •Scanning Active Time •Flash On Time •Flash Off Time •Double Read Timeout 	<ul style="list-style-type: none"> •Stand /Base Detection Behavior •Stand Mode/Object Detection Indication (Stand Mode Flash) •Stand Mode/Object Detection Sensitivity •Stand Mode/Object Detection Illumination Off Time •Corded Stand Mode
BEEPER CONTROL starting on page 99	
<ul style="list-style-type: none"> •Power On Alert •Good Read Beep Type •Good Read Beep Frequency 	<ul style="list-style-type: none"> •Good Read Beep Length •Good Read Beep Volume
LED CONTROL starting on page 103	
<ul style="list-style-type: none"> •RGB Good Read Enable •RGB Good Read Color •Good Read LED Duration 	<ul style="list-style-type: none"> •Good Read: When to Indicate •Green Spot Duration •Illuminator Intensity (Power Level)
CAMERA CONTROL starting on page 107	
<ul style="list-style-type: none"> •Aiming Pointer 	

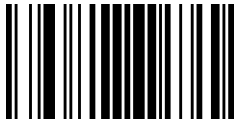

SCANNING FEATURES

Scan Mode

Selects the reader's scan operating mode. See [page 239](#) in "References" for descriptions.

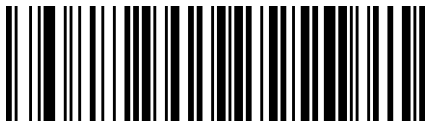

★ Scan Mode = Trigger Single



Scan Mode = Trigger Hold Multiple



Scan Mode = Trigger Pulse Multiple



Scan Mode = Flashing



Scan Mode = Always On



Scan Mode = Object Detection



Scan Mode = Trigger Object Sense

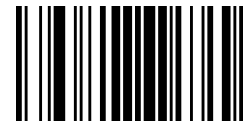

Scanning Active Time

This setting specifies the amount of time that the reader stays in scan ON state once the state is entered. The range for this setting is from 1 to 255 seconds in 1-second increments. See [page 240](#) in “References” for further description of this feature.



Scanning Active Time = 3 seconds



★ Scanning Active Time = 5 seconds



Scanning Active Time = 8 seconds

Flash On Time

This feature specifies the ON time for the indicator LED while in Flash Mode. The selectable range is 100 to 9,900 milliseconds (0.1 to 9.9 seconds), in 100 millisecond increments. See [page 242](#) in “References” for detailed information on setting this feature.



Select Flash ON Time Setting

To configure this feature, scan the ENTER/EXIT PROGRAMMING MODE bar code above, then the bar code at left followed by the digits from the Alphanumeric characters in [Appendix D, Keypad](#) representing your desired character(s). End by scanning the ENTER/EXIT bar code again.

Make a mistake? Scan the CANCEL bar code to abort and not save the entry string. You can then start again at the beginning.



CANCEL

★ 10 = Flash is ON for 1 Second



Flash Off Time

This feature specifies the OFF time for the indicator LED while in Flash Mode. The selectable range is 100 to 9,900 milliseconds (0.1 to 9.9 seconds), in 100 millisecond increments. See [page 243](#) in “References” for detailed information on setting this feature.



Select Flash OFF Time Setting

To configure this feature, scan the ENTER/EXIT PROGRAMMING MODE bar code above, then the bar code at left followed by the digits from the Alphanumeric characters in [Appendix D, Keypad](#) representing your desired character(s). End by scanning the ENTER/EXIT bar code again.

Make a mistake? Scan the CANCEL bar code to abort and not save the entry string. You can then start again at the beginning.



CANCEL

★06 = Flash is OFF for 600ms

Double Read Timeout

Double Read Timeout prevents a double read of the same label by setting the minimum time allowed between reads of labels of the same symbology and data. If the unit reads a label and sees the same label again within the specified timeout, the second read is ignored. Double Read Timeout does not apply to scan modes that require a trigger pull for each label read.



Double Read Timeout = 0.1 Second



Double Read Timeout = 0.2 Second



Double Read Timeout = 0.3 Second



Double Read Timeout = 0.4 Second

Double Read Timeout (continued)



★ Double Read Timeout = 0.6 Second

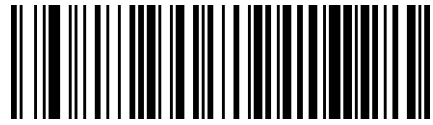

Double Read Timeout = 0.5 Second

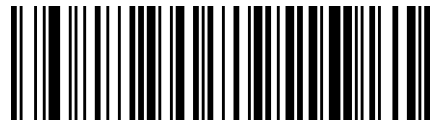

Double Read Timeout = 0.7 Second

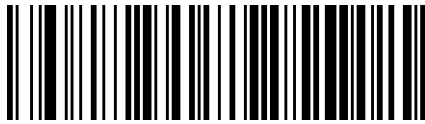

Double Read Timeout = 0.8 Second

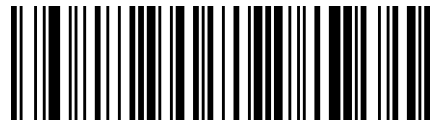

Double Read Timeout = 0.9 Second



Double Read Timeout = 1 Second



Stand /Base Detection Behavior

Specifies the behavior of the reader when stationary in a stand. There are two conditions which cause the reader to switch to Stand Mode/Object Detection:

- The reader is configured to switch to Stand Mode/Object Detection when stationary.
- The reader is placed into the cradle of the base station.

Below are further options concerning Stand Operation.

Ignore Autorecognition: Disables mode switching when the reader is placed in a stand.

Switch to Stand Mode/Object Detection: Automatically switches the reader to Stand Mode/Object Detection when the reader is placed in the stand.

Switch to Always On: Automatically switches the reader to Always On mode when the reader is placed in the stand.

Switch to Flashing: Automatically switches the reader to Flash Mode when the reader is placed in the stand.

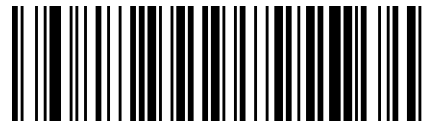

Stand/Base Detection Behavior = Ignore Autorecognition
(do not change behavior)

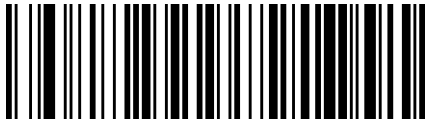

★ Stand/Base Detection Behavior =
Switch to Stand Mode/Object Detection



Stand/Base Detection Behavior = Switch to Always On

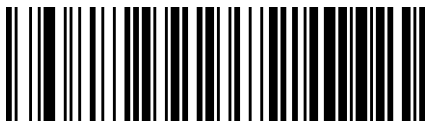

Stand/Base Detection Behavior = Switch to Flashing

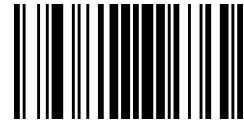

Stand Mode/Object Detection Indication (Stand Mode Flash)

This operation is useful for indicating when the reader is in Stand Mode. If enabled, the blue indicator will blink when Stand Mode scanning is active.



★ Stand Mode/Object Detection Indication = Disable



Stand Mode/Object Detection Indication = Enable

Stand Mode/Object Detection Sensitivity

Sets the sensitivity level for stand mode/object detection wakeup. Choices are low, medium and high.



Stand/Base Detection Sensitivity = Low



★ Stand/Base Detection Sensitivity = Medium



Stand/Base Detection Sensitivity = High



Stand Mode/Object Detection Illumination Off Time

Specifies the amount of time reader illumination stays off after pulling the trigger when in Stand Mode/Object Detection. The configurable range is 01 to 32 by 01 in increments of 500ms (500ms to 16 seconds).

Set Illumination OFF Time

To configure, scan the ENTER/EXIT PROGRAMMING MODE bar code above, then the bar code at left followed by the digits from the Alphanumeric characters in [Appendix D, Keypad](#) representing your desired character(s). End by scanning the ENTER/EXIT bar code.

Make a mistake? Scan the CANCEL bar code to abort and not save the entry string. You can then start again at the beginning.



CANCEL

★04 = Illumination OFF Time 1 second

Corded Stand Mode

This parameter sets the Stand Mode operation for corded models only.



★ Corded Stand Mode = Disable



Corded Stand Mode = Generic Stand



Corded Stand Mode = Permanent Stand



Corded Stand Mode = Precise Stand

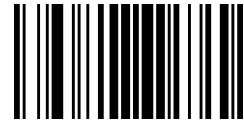

BEEPER CONTROL

Power On Alert

Disables or enables the indication (from the Beeper) that the reader is receiving power.

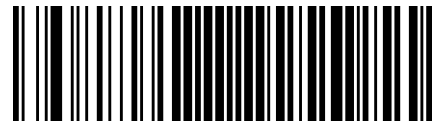

Power On Alert = Disable (No Audible Indication)



★ Power On Alert = Power-up Beep

Good Read Beep Type

Specifies whether the good read beep has a mono or bitonal beep sound.

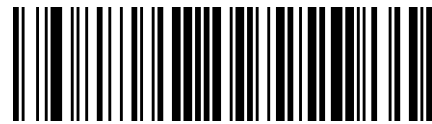

★ Good Read Beep Type = Mono



Good Read Beep Type = Bitonal

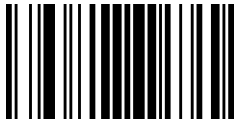

Good Read Beep Frequency

Adjusts the good read beep to sound at a selectable low, medium or high frequency, selectable from the list below. (Controls the beeper's pitch/tone.)



Good Read Beep Frequency = Low

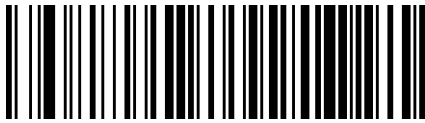

Good Read Beep Frequency = Medium



★ Good Read Beep Frequency = High

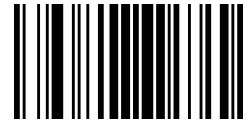

Good Read Beep Length



★ Good Read Beep Length = 80 msec



Good Read Beep Length = 60 msec



Good Read Beep Length = 100 msec

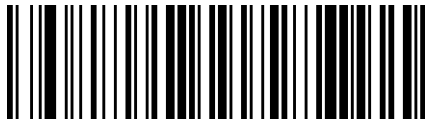

Good Read Beep Length = 120 msec



Good Read Beep Length = 140 msec



Good Read Beep Length = 160 msec



Good Read Beep Length = 180 msec



Good Read Beep Length = 200 msec



Good Read Beep Volume

Selects the beeper volume (loudness) upon a good read beep. There are three selectable volume levels.



Good Read Beep Volume = Beeper Off



Good Read Beep Volume = Low



Good Read Beep Volume = Medium



★ Good Read Beep Volume = High

LED CONTROL

RGB Good Read Enable

Specifies whether the RGB good read indicator is enabled or disabled.



★ RGB Good Read = Enable

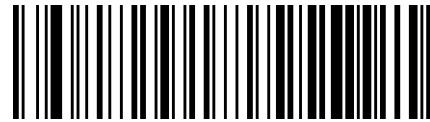

RGB Good Read = Disable

RGB Good Read Color

Selects the good read LED color.



★ RGB Good Read Color = GREEN



RGB Good Read Color = RED



RGB Good Read Color = BLUE



Good Read LED Duration

This feature specifies the amount of time that the Good Read LED remains on following a good read. The good read LED on time can be set within a range of 100 milliseconds to 25,500 milliseconds (0.1 to 25.5 seconds) in 100ms increments. A setting of 00 keeps the LED on until the next trigger pull.

See [page 244](#) in “References” for detailed instructions and examples for setting this feature.



Good Read LED Duration Setting =
Keep LED on until next trigger pull



Select Good Read LED Duration Setting

To configure this feature, scan the ENTER/EXIT PROGRAMMING MODE bar code above, then the bar code at left followed by the digits from the Alphanumeric characters in [Appendix D, Keypad](#) representing your desired character(s). End by scanning the ENTER/EXIT bar code again.

Make a mistake? Scan the CANCEL bar code to abort and not save the entry string. You can then start again at the beginning.

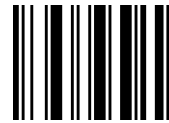

CANCEL

★003 = Good Read LED stays on for 300 ms.



NOTE: Indicators are dimmed during sleep.

Good Read: When to Indicate

This feature specifies when the reader will provide indication (beep and/or flash its green LED) upon successfully reading a bar code.

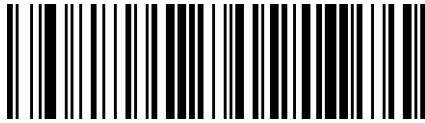

Indicate Good Read = After Transmit

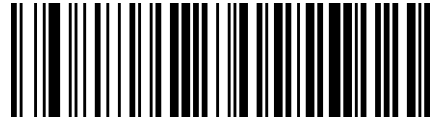

★ Indicate Good Read = After Decode

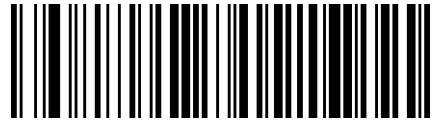

Indicate Good Read =
After CTS goes inactive then active



Green Spot Duration

Specifies the duration of the good read pointer beam after a good read.



Green Spot Duration = Disable (Green Spot is Off)

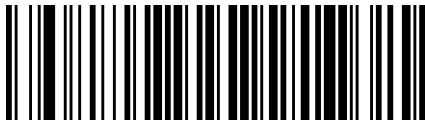

★ Green Spot Duration = Short (300 msec)



Green Spot Duration = Medium (500 msec)

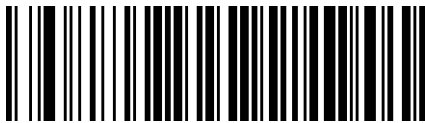

Green Spot Duration = Long (800 msec)

Illuminator Intensity (Power Level)

This setting selects the illumination level for bar code reading.

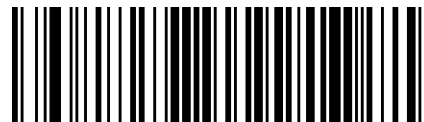

Illuminator Intensity = Low



Illuminator Intensity = Medium

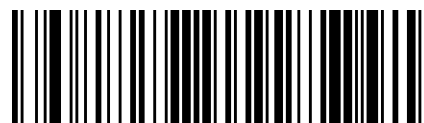

★ Illuminator Intensity = High



CAMERA CONTROL

Aiming Pointer

Enables/disables the aiming pointer for all symbologies.

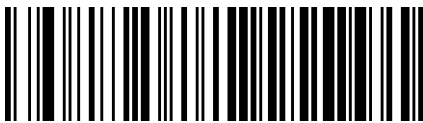

★ Aiming Pointer = Enable

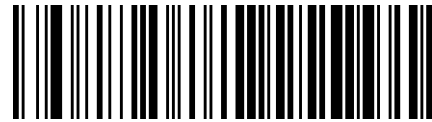

Aiming Pointer = Disable



Aiming Pointer = Green Spot

CONFIGURATION | MOTION FEATURES

SECTION CONTENTS

MOTION FEATURES starting on page 109

- Motionless Timeout
- Motion Sensitivity

- High Motion Immunity
- Motion Aiming Control

MOTION FEATURES

Motionless Timeout

The period of time that must expire without detecting any motion, before the scanner is assumed to be in a motionless condition. The selectable setting is from 500 to 25,500 milliseconds in 100 millisecond increments. This option relates to such features as the Stand Mode/Object Detection scanning with respect to motion.

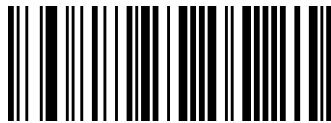

Select Motionless Timeout

To configure this feature, scan the ENTER/EXIT PROGRAMMING MODE bar code above, then the bar code at left followed by the digits from the Alphanumeric characters in [Appendix D, Keypad](#) representing your desired character(s). End by scanning the ENTER/EXIT bar code again.

Make a mistake? Scan the CANCEL bar code to abort and not save the entry string. You can then start again at the beginning.

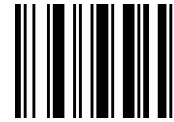

CANCEL

★14 = Motionless Timeout for 2 seconds

Motion Sensitivity

Sets the sensitivity level for motion detection wakeup. Choices are low, medium and high.



Motion Sensitivity = Low



★ Motion Sensitivity = Medium



Motion Sensitivity = High



High Motion Immunity

When set to triggerless scanning mode (e.g. Flashing, Always On, Stand Mode/Object Detection, etc.) the reading capabilities can be modified according to two main goals:

- increased performance for rapidly moving barcodes - Enable High Motion Immunity:
- increased performance for distant barcodes - Disable High Motion Immunity:

Depending on specific environmental conditions, application requirements, or expected performance, choose the best solution.



★ High Motion Immunity = Disable

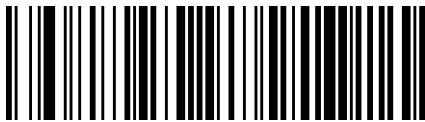

High Motion Immunity = Enable

Motion Aiming Control

Enables/Disables the Aiming system when motion is detected.



Motion Aiming Control = Disable



★ Motion Aiming Control = Enable

CONFIGURATION | SYMBOLOGIES

SECTION CONTENTS	
DISABLE ALL SYMBOLOGIES starting on page 112	
• COUPON CONTROL starting on page 112	• GS1-128 starting on page 145
• UPC-A starting on page 113	• INTERLEAVED 2 OF 5 (I 2 OF 5) starting on page 145
• UPC-E starting on page 115	• INTERLEAVED 2 OF 5 CIP HR starting on page 149
• EAN-13 starting on page 118	• STANDARD 2 OF 5 starting on page 150
• EAN-8 starting on page 121	• COMPRESSED 2 OF 5 starting on page 153
• UPC/EAN GLOBAL SETTINGS starting on page 123	• DATALOGIC 2 OF 5 starting on page 156
• GS1 DATABAR™ OMNIDIRECTIONAL starting on page 127	• INDUSTRIAL 2 OF 5 starting on page 159
• GS1 DATABAR™ EXPANDED starting on page 128	• IATA starting on page 162
• GS1 DATABAR™ LIMITED starting on page 131	• FOLLETT 2 OF 5 starting on page 163
• CODE 39 starting on page 132	• CODABAR starting on page 164
• TRIOPTIC CODE starting on page 137	• ABC CODABAR starting on page 170
• CODE 39 DANISH PPT starting on page 137	• ISBT 128 starting on page 172
• CODE 39 PZN starting on page 138	• CODE 11 starting on page 175
• CODE 39 LA POSTE starting on page 138	• CODE 93 starting on page 178
• CODE 32 (ITALIAN PHARMACEUTICAL) starting on page 139	• MSI starting on page 182
• CODE 39 CIP (FRENCH PHARMACEUTICAL) starting on page 140	• PLESSEY starting on page 185
• CODE 128 starting on page 141	• BC412 starting on page 188

DISABLE ALL SYMBOLOGIES

Scan this label to disable all symbologies.



Disable All Symbologies

COUPON CONTROL

This feature is used to control the method of processing coupon labels.

Options are:

- Allow all — allow all coupon bar codes to be decoded
- Enable only UPC/EAN — enables only UPC/EAN coupon decoding
- Enable only GS1 DataBar — enables only GS1 DataBar coupon decoding

To set this feature:

1. Scan the Enter/Exit bar code.
2. Scan either the enable or disable bar code below. You'll need to cover any unused bar codes on this and the facing page to ensure that the scanner sees only the bar code you intend to scan.
3. Complete the programming sequence by scanning the Enter/Exit bar code.



Coupon Control = Allow all



★ Coupon Control = Enable only UPC/EAN



Coupon Control = Enable only GS1 DataBar

UPC-A

The following options apply to the UPC-A symbology.

UPC-A Enable/Disable

When disabled, the scanner will not read UPC-A bar codes.

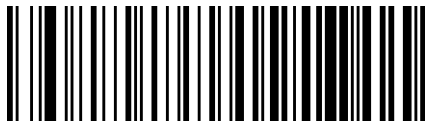

★ UPC-A = Enable

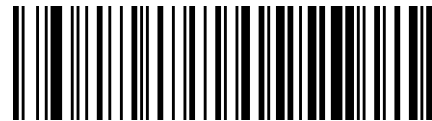

UPC-A = Disable

UPC-A Check Character Transmission

Enable this option to transmit the check character along with UPC-A bar code data.

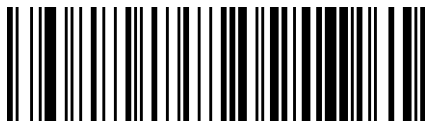

★ UPC-A Check Character Transmission = Send

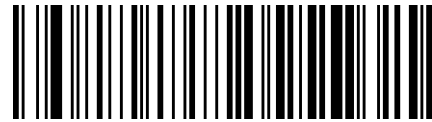

UPC-A Check Character Transmission = Don't Send



Expand UPC-A to EAN-13

Expands UPC-A data to the EAN-13 data format. Selecting this feature also changes the symbology ID to match those required for EAN-13.



★ UPC-A to EAN-13 = Don't Expand



UPC-A to EAN-13 = Expand

UPC-A Number System Character Transmission

This feature enables/disables transmission of the UPC-A number system character.

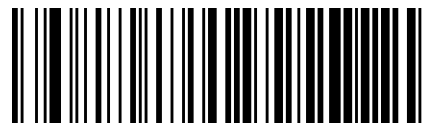

UPC-A Number System Character = Do not transmit



★ UPC-A Number System Character = Transmit

UPC-E

The following options apply to the UPC-E symbology.

UPC-E Enable/Disable

When disabled, the scanner will not read UPC-E bar codes.

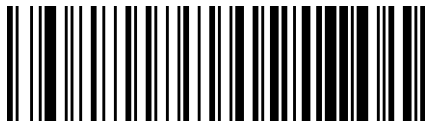

★ UPC-E = Enable

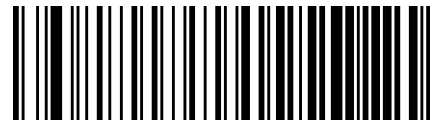

UPC-E = Disable

UPC-E Check Character Transmission

Enable this option to transmit the check character along with UPC-E bar code data.

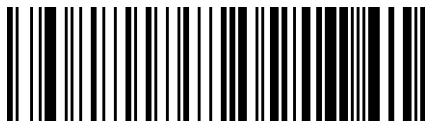

★ UPC-E Check Character Transmission = Send

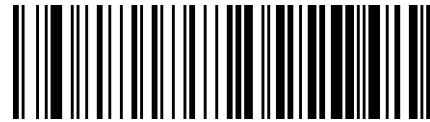

UPC-E Check Character Transmission = Don't Send

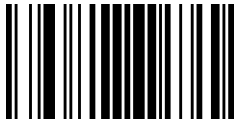

Expand UPC-E to EAN-13

Expands UPC-E data to the EAN-13 data format. Selecting this feature also changes the symbology ID to match those required for EAN-13.



★ UPC-E to EAN-13 = Don't Expand



UPC-E to EAN-13 = Expand

Expand UPC-E to UPC-A

Expands UPC-E data to the UPC-A data format. Selecting this feature also changes the symbology ID to match those required for UPC-A.

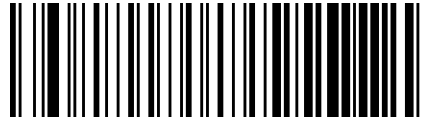

★ UPC-E to UPC-A = Don't Expand



UPC-E to UPC-A = Expand

UPC-E Number System Character Transmission

This feature enables/disables transmission of the UPC-E number system character.



UPC-E Number System Character = Do not transmit



★ UPC-E Number System Character = Transmit

GTIN Formatting

This feature enables/disables the ability to convert UPC-E, UPC-A, EAN-8, and EAN-13 labels into the GTIN 14-character format.

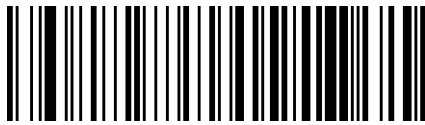

GTIN Formatting = Enable



★ GTIN Formatting = Disable



EAN-13

The following options apply to the EAN-13 symbology.

EAN-13 Enable/Disable

When disabled, the scanner will not read EAN-13 bar codes.



EAN-13 = Disable



★ EAN-13 = Enable

EAN-13 Check Character Transmission

Enable this option to transmit the check character along with EAN-13 bar code data.

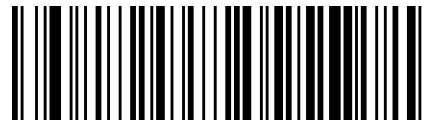

EAN-13 Check Character Transmission = Don't Send



★ EAN-13 Check Character Transmission = Send

EAN-13 Flag 1 Character

Enables/disables transmission of an EAN/JAN-13 Flag1 character. The Flag 1 character is the first character of the label



EAN-13 Flag 1 Char = Don't transmit

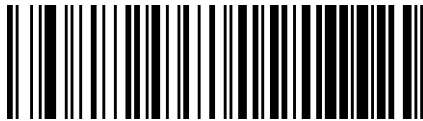

★ EAN-13 Flag 1 Char = Transmit

EAN-13 to ISBN Conversion

This option enables/disables conversion of EAN-13/JAN-13 Bookland labels starting with 978 to ISBN labels.

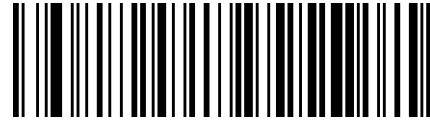

★ EAN-13 ISBN Conversion = Disable



EAN-13 ISBN Conversion = Enable



EAN-13 to ISSN Conversion

Enables/disables conversion of EAN/JAN-13 Bookland labels starting with 977 to ISSN labels.

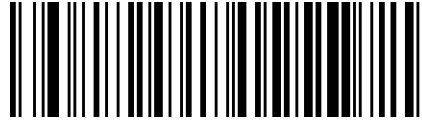

★ ISSN = Disable



ISSN = Enable

EAN-8

The following options apply to the EAN-8 symbology.

EAN-8 Enable/Disable

When disabled, the scanner will not read EAN-8 bar codes.



★ EAN-8 = Enable



EAN-8 = Disable

EAN-8 Check Character Transmission

Enable this option to transmit the check character along with EAN-8 bar code data.



★ EAN-8 Check Character Transmission = Send

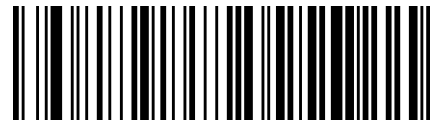

EAN-8 Check Character Transmission = Don't Send



Expand EAN-8 to EAN-13

Enable this option to expand EAN-8/JAN-8 labels to EAN-13/JAN-13.

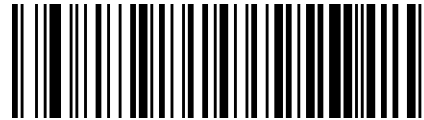

★ EAN-8 to EAN-13 = Don't Expand

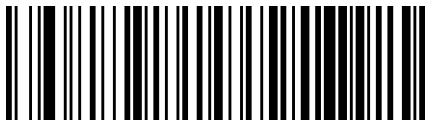

EAN-8 to EAN-13 = Expand

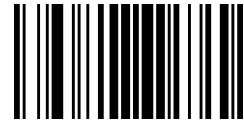

UPC/EAN GLOBAL SETTINGS

This section provides configuration settings for UPC-A, UPC-E, EAN 13 and EAN 8 symbologies, and affects all of these unless otherwise marked for each feature description.

UPC/EAN Price Weight Check

This feature enables/disables calculation and verification of price/weight check digits.

Options are

- Disabled
- Enable 4-digit price-weight check-digit calculation
- Enable 5-digit price-weight check-digit calculation
- Enable European 4-digit price-weight check-digit calculation
- Enable European 5-digit price-weight check-digit calculation



★ Price Weight Check = Disabled



Price Weight Check = 4-digit price-weight check



Price Weight Check = 5-digit price-weight check



Price Weight Check = European 4-digit price-weight check



Price Weight Check = European 5-digit price-weight check

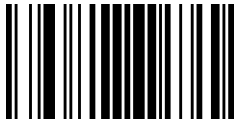

UPC/EAN Quiet Zones

This feature specifies the number of quiet zones for UPC/EAN labels. Quiet zones are blank areas at the ends of a bar code, typically 10 times the width of the narrowest bar or space in the label. The property applies to all EAN-UPC symbologies globally and to the ADD-ONS.



★ UPC/EAN Quiet Zones = Two Modules

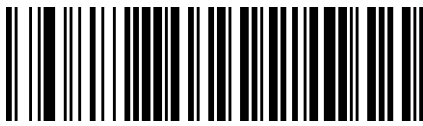

UPC/EAN Quiet Zones = Three Modules

Add-Ons

The following features apply to optional add-ons.



NOTE: Contact Customer Support for advanced programming of optional and conditional add-ons.

Optional Add-ons

The scanner can be enabled to optionally read the following add-ons (supplementals):

- P2
- P5



NOTE: If a UPC/EAN base label and a an add-on are both decoded, the scanner will transmit the base label and add-on. If a UPC/EAN base label is decoded without an add-on, the base label will be transmitted without an add-on.

Conditional add-on settings (if enabled) are considered by the scanner before optional add-on settings.



Optional Add-Ons = Enable P2



★ Optional Add-Ons = Disable P2



★ Optional Add-Ons = Disable P5



Optional Add-Ons = Enable P5



Optional Add-On Timer

This option sets the time the scanner will look for an add-on when an add-on fragment has been seen and optional add-ons are enabled.

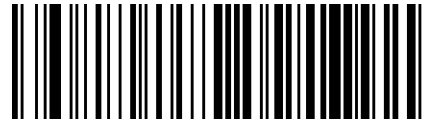

Optional Add-on Timer = 10ms

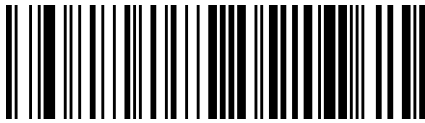

Optional Add-on Timer = 20ms



Optional Add-on Timer = 30ms

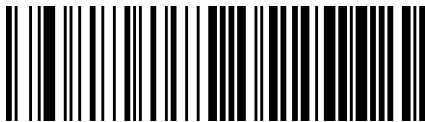

Optional Add-on Timer = 50ms



★ Optional Add-on Timer = 70ms



Optional Add-on Timer = 100ms



Optional Add-on Timer = 160ms



GS1 DATABAR™ OMNIDIRECTIONAL

The following options apply to the GS1 DataBar Omnidirectional (formerly RSS-14) symbology.

GS1 DataBar Omnidirectional Enable/Disable

When disabled, the scanner will not read GS1 DataBar Omnidirectional bar codes.



★ GS1 DataBar Omnidirectional = Disable

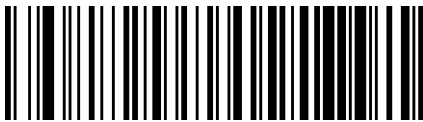

GS1 DataBar Omnidirectional = Enable

GS1 DataBar Omnidirectional to GS1-128 Emulation

When enabled, GS1 DataBar Omnidirectional bar codes will be translated to the GS1-128 label data format.

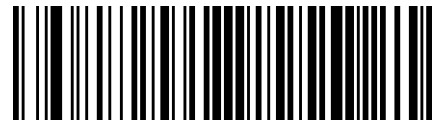

★ GS1 DataBar Omnidirectional to GS1-128 Emulation = Disable

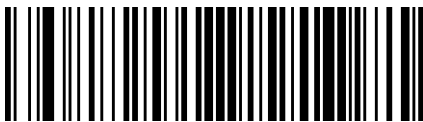

GS1 DataBar Omnidirectional to GS1-128 Emulation = Enable



GS1 DATABAR™ EXPANDED

The following options apply to the GS1 DataBar Expanded (formerly RSS Expanded) symbology.

GS1 DataBar Expanded Enable/Disable

When disabled, the scanner will not read GS1 DataBar Expanded bar codes.



★ GS1 DataBar Expanded = Disable

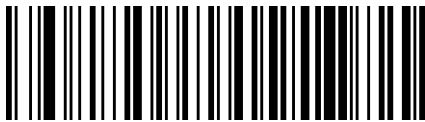

GS1 DataBar Expanded = Enable

GS1 DataBar Expanded to GS1-128 Emulation

When enabled, GS1 DataBar Expanded bar codes will be translated to the GS1-128 label data format.



★ GS1 DataBar Expanded to GS1-128 Emulation = Disable

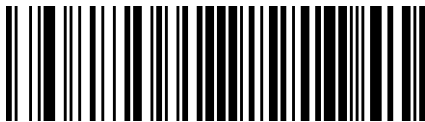

GS1 DataBar Expanded to GS1-128 Emulation = Enable

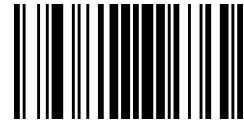

GS1 DataBar Expanded Length Control

This feature specifies either variable length decoding or fixed length decoding for the GS1 DataBar Expanded symbology.

Variable Length: For variable-length decoding, a minimum length may be set.

Fixed Length: For fixed-length decoding, two different lengths may be set.



★ GS1 DataBar Expanded Length Control
= Variable Length

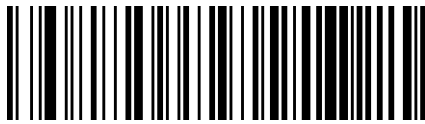

GS1 DataBar Expanded Length Control = Fixed Length

GS1 DataBar Expanded Set Length 1

This feature specifies one of the bar code lengths for "GS1 DataBar Expanded Length Control" on page 129. Length 1 is the minimum label length if in Variable Length Mode, or the first fixed length if in Fixed Length Mode. Length includes the bar code's data characters only.

The length can be set from 1 to 74 characters. See "Set Length 1" on page 247 for more detailed programming instructions.

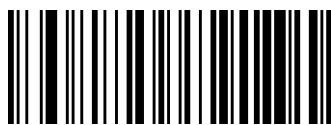

Select GS1 DataBar Expanded Set Length 1 Setting

To configure this feature, scan the ENTER/EXIT PROGRAMMING MODE bar code above, then the bar code at left followed by the digits from the Alphanumeric characters in [Appendix D, Keypad](#) representing your desired character(s). End by scanning the ENTER/EXIT bar code again.

Make a mistake? Scan the CANCEL bar code to abort and not save the entry string. You can then start again at the beginning.



CANCEL

★ Length 1 = 01 (one character)



GS1 DataBar Expanded Set Length 2

This feature specifies one of the bar code lengths for "GS1 DataBar Expanded Length Control" on page 129. Length 2 is the maximum label length if in Variable Length Mode, or the second fixed length if in Fixed Length Mode. Length includes the bar code's data characters only.

The length can be set from 1 to 74 characters. A setting of 00 specifies to ignore this length (only one fixed length). See "Set Length 2" on page 248 for more detailed programming instructions.



Select GS1 DataBar Expanded Set Length 2 Setting

To configure this feature, scan the ENTER/EXIT PROGRAMMING MODE bar code above, then the bar code at left followed by the digits from the Alphanumeric characters in Appendix D, Keypad representing your desired character(s). End by scanning the ENTER/EXIT bar code again.

Make a mistake? Scan the CANCEL bar code to abort and not save the entry string. You can then start again at the beginning.

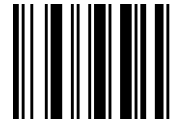

CANCEL

★ Length 2 = 74 (74 characters)



GS1 DATABAR™ LIMITED

The following options apply to the GS1 DataBar Limited (formerly RSS Limited) symbol-ogy.

GS1 DataBar Limited Enable/Disable

When disabled, the scanner will not read GS1 DataBar Limited bar codes.



★ GS1 DataBar Limited = Disable



GS1 DataBar Limited = Enable

GS1 DataBar Limited to GS1-128 Emulation

When enabled, GS1 DataBar Limited bar codes will be translated to the GS1-128 label data format.



★ GS1 DataBar Limited to GS1-128 Emulation = Disable



GS1 DataBar Limited to GS1-128 Emulation = Enable

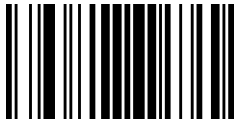

CODE 39

The following options apply to the Code 39 symbology.

Code 39 Enable/Disable

When disabled, the scanner will not read Code 39 bar codes.



Code 39 = Disable

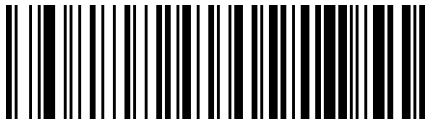

★ Code 39 = Enable

Code 39 Check Character Calculation

Enable this option to enable/disable calculation and verification of an optional Code 39 check character. When disabled, any check character in the label is treated as a data character.



★ Code 39 Check Character Calculation = Don't Calculate

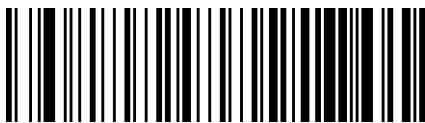

Code 39 Check Character Calculation = Calculate Std Check



Code 39 Check Character Calculation = Calculate Mod 7 Check



Code 39 Check Character Calculation = Enable Italian Post Check

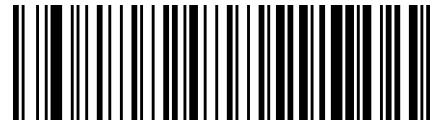
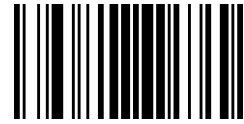

Code 39 Check Character Calculation
= Enable Daimler Chrysler Check

Code 39 Check Character Transmission

Enable this option to transmit the check character along with Code 39 bar code data.



Code 39 Check Character Transmission = Don't Send

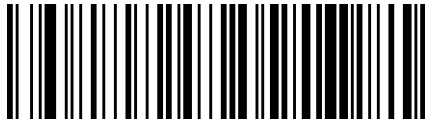

★ Code 39 Check Character Transmission = Send

Code 39 Start/Stop Character Transmission

Enable this option to enable/disable transmission of Code 39 start and stop characters.



★ Code 39 Start/Stop Character Transmission
= Don't Transmit



Code 39 Start/Stop Character Transmission
= Transmit



Code 39 Full ASCII

In Code 39 decoding, this enables/disables the translation of Code 39 characters to Code 39 full-ASCII characters.

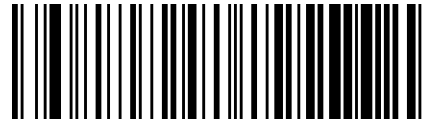

★ Code 39 Full ASCII = Disable

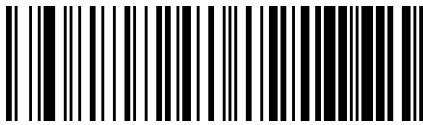

Code 39 Full ASCII = Enable

Code 39 Quiet Zones

This feature specifies the number of quiet zones for Code 39 labels. Quiet zones are blank areas at the ends of a bar code and are typically 10 times the width of the narrowest bar or space in the label.



Code 39 Quiet Zones = Quiet Zone on one side



Code 39 Quiet Zones = Quiet Zones on two sides



Code 39 Quiet Zones = Auto



Code 39 Quiet Zones = Virtual Quiet Zones on two sides



★ Code 39 Quiet Zones =
Small Quiet Zones on two sides

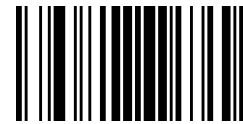

Code 39 Length Control

This feature specifies either variable length decoding or fixed length decoding for the Code 39 symbology.

Variable Length: For variable-length decoding, a minimum length may be set.

Fixed Length: For fixed-length decoding, two different lengths may be set.



★ Code 39 Length Control
= Variable Length



Code 39 Length Control = Fixed Length

Code 39 Set Length 1

This feature specifies one of the bar code lengths for "[Code 39 Length Control](#)" on page 135. Length 1 is the minimum label length if in Variable Length Mode, or the first fixed length if in Fixed Length Mode. Length includes the bar code's check, data, and full-ASCII shift characters. The length does not include start/stop characters.

The length can be set from 0 to 50 characters. See "[Set Length 1](#)" on page 247 for more detailed programming instructions.



Select Code 39 Set Length 1 Setting

To configure this feature, scan the ENTER/EXIT PROGRAMMING MODE bar code above, then the bar code at left followed by the digits from the Alphanumeric characters in [Appendix D, Keypad](#) representing your desired character(s). End by scanning the ENTER/EXIT bar code again.

Make a mistake? Scan the CANCEL bar code to abort and not save the entry string. You can then start again at the beginning.



CANCEL

★ Length 1 = 02 (2 characters)



Code 39 Set Length 2

This feature specifies one of the bar code lengths for "[Code 39 Length Control](#)" on page 135. Length 2 is the maximum label length if in Variable Length Mode, or the second fixed length if in Fixed Length Mode. Length includes the bar code's check, data, and full-ASCII shift characters. The length does not include start/stop characters.

The length can be set from 1 to 50 characters. A setting of 00 specifies to ignore this length (only one fixed length). See "[Set Length 2](#)" on page 248 for more detailed programming instructions.



Select Code 39 Set Length 2 Setting

To configure this feature, scan the ENTER/EXIT PROGRAMMING MODE bar code above, then the bar code at left followed by the digits from the Alphanumeric characters in [Appendix D, Keypad](#) representing your desired character(s). End by scanning the ENTER/EXIT bar code again.

Make a mistake? Scan the CANCEL bar code to abort and not save the entry string. You can then start again at the beginning.

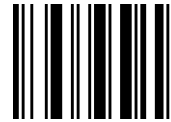

CANCEL

★ Length 2 = 50 (50 characters)

TRIOPTIC CODE

The following options apply to the trioptic symbology.

Trioptic Code Enable/Disable

When disabled, the scanner will not read Trioptic Code bar codes.

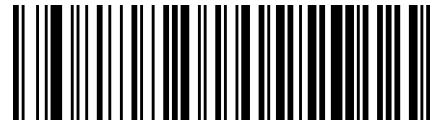

★ Trioptic Code = Disable

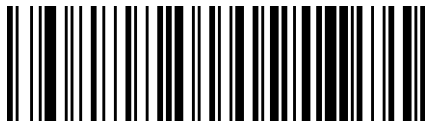

Trioptic Code = Enable

CODE 39 DANISH PPT

The following options apply to the Code 39 Danish PPT symbology.

Code 39 Danish PPT Enable/Disable

When disabled, the scanner will not read Code 39 Danish PPT bar codes.



★ Code 39 Danish PPT = Disable



Code 39 Danish PPT = Enable



CODE 39 PZN

The following options apply to the Code 39 PZN symbology.

Code 39 PZN Enable/Disable

When disabled, the scanner will not read Code 39 PZN bar codes.



★ Code 39 PZN = Disable

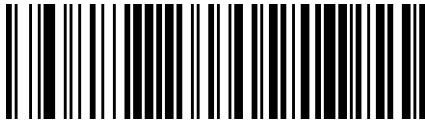

Code 39 PZN = Enable

CODE 39 LA POSTE

The following options apply to the Code 39 La Poste symbology.

Code 39 La Poste Enable/Disable

When disabled, the scanner will not read Code 39 La Poste bar codes.



★ Code 39 La Poste = Disable



Code 39 La Poste = Enable

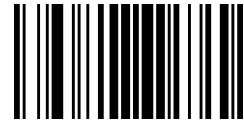

CODE 32 (ITALIAN PHARMACEUTICAL)

The following options apply to the Code 32 symbology.

Code 32 Enable/Disable

When disabled, the scanner will not read Code 32 bar codes.

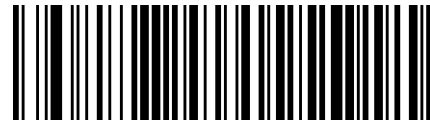

★ Code 32 = Disable

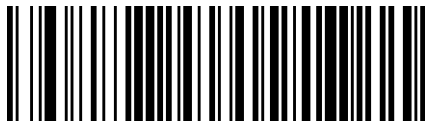

Code 32 = Enable

Code 32 Feature Setting Exceptions



NOTE: The following features are set for Code 32 by using these Code 39 settings:

"Code 39 Quiet Zones" on page 134

"Code 39 Length Control" on page 135

Code 32 Check Character Transmission

Enable this option to transmit the check character along with Code 32 bar code data.



★ Code 32 Check Character Transmission = Don't
Send



Code 32 Check Character Transmission = Send



Code 32 Start/Stop Character Transmission

Enable this option to enable/disable transmission of Code 32 start and stop characters.



★ Code 32 Start/Stop Character Transmission
= Don't Transmit

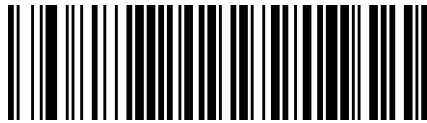

Code 32 Start/Stop Character Transmission
= Transmit

CODE 39 CIP (FRENCH PHARMACEUTICAL)

The following options apply to the Code 39 CIP symbology.

Code 39 CIP Enable/Disable

Enables/Disables ability of the scanner to decode Code 39 CIP labels.



★ Code 39 CIP = Disable



Code 39 CIP = Enable

CODE 128

The following options apply to the Code 128 symbology.

Code 128 Enable/Disable

Enables/Disables ability of the scanner to decode Code 128 labels.

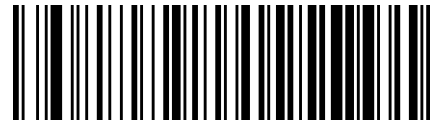

Code 128 = Disable



★ Code 128 = Enable

Expand Code 128 to Code 39

This feature enables/disables expansion of Code 128 labels to Code 39 labels. When enabled, the label identifier for a Code 128 label shall be set to Code 39 and all Code 39 formatting control shall be applied to the label.



★ Code 128 to Code 39 = Don't Expand



Code 128 to Code 39 = Expand



Code 128 Check Character Transmission

Enable this option to transmit the check character along with Code 128 bar code data.



★ Code 128 Check Character Transmission =
Don't Send

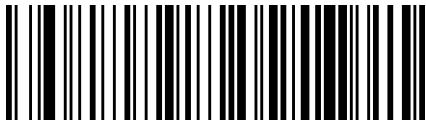

Code 128 Check Character Transmission = Send

Code 128 Function Character Transmission

Enables/disables transmission of Code128 function characters 1, 2, 3, and 4.

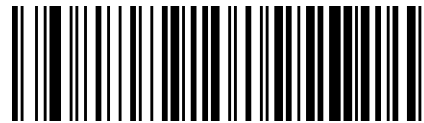

★ Code 128 Function Character Transmission =
Don't Send

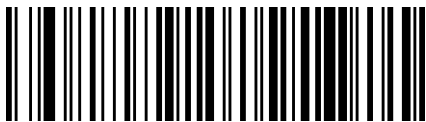

Code 128 Function Character Transmission = Send

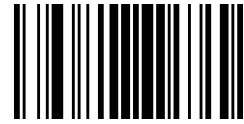

Code 128 Quiet Zones

This feature specifies the number of quiet zones for Code 128 labels. Quiet zones are blank areas at the ends of a bar code and are typically 10 times the width of the narrowest bar or space in the label.



Code 128 Quiet Zones = No Quiet Zones

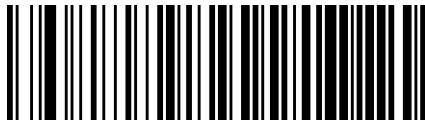

Code 128 Quiet Zones = Quiet Zone on one side



Code 128 Quiet Zones = Quiet Zones on two sides



★ Code 128 Quiet Zones = Auto



Code 128 Quiet Zones = Virtual Quiet Zones on two sides

Code 128 Length Control

This feature specifies either variable length decoding or fixed length decoding for the Code 128 symbology.

Variable Length: For variable-length decoding, a minimum length may be set.

Fixed Length: For fixed-length decoding, two different lengths may be set.



★ Code 128 Length Control = Variable Length



Code 128 Length Control = Fixed Length



Code 128 Set Length 1

This feature specifies one of the bar code lengths for "[Code 128 Length Control](#)" on page 143. Length 1 is the minimum label length if in Variable Length Mode, or the first fixed length if in Fixed Length Mode. Length includes the bar code's data characters only.

The length can be set from 1 to 80 characters. See "[Set Length 1](#)" on page 247 for more detailed programming instructions.



Select Code 128 Set Length 1 Setting

To configure this feature, scan the ENTER/EXIT PROGRAMMING MODE bar code above, then the bar code at left followed by the digits from the Alphanumeric characters in [Appendix D, Keypad](#) representing your desired character(s). End by scanning the ENTER/EXIT bar code again.

Make a mistake? Scan the CANCEL bar code to abort and not save the entry string. You can then start again at the beginning.



CANCEL

★ Length 1 = 01 (one character)

Code 128 Set Length 2

This feature specifies one of the bar code lengths for "[Code 128 Length Control](#)" on page 143. Length 2 is the maximum label length if in Variable Length Mode, or the second fixed length if in Fixed Length Mode. Length includes the bar code's data characters only.

The length can be set from 1 to 80 characters. A setting of 00 specifies to ignore this length (only one fixed length). See "[Set Length 2](#)" on page 248 for more detailed programming instructions.

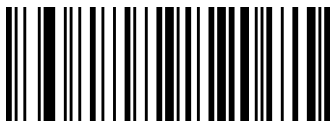

Select Code 128 Set Length 2 Setting

To configure this feature, scan the ENTER/EXIT PROGRAMMING MODE bar code above, then the bar code at left followed by the digits from the Alphanumeric characters in [Appendix D, Keypad](#) representing your desired character(s). End by scanning the ENTER/EXIT bar code again.

Make a mistake? Scan the CANCEL bar code to abort and not save the entry string. You can then start again at the beginning.



CANCEL

★ Length 2 = 80 (80 characters)

GS1-128

The following options apply to the GS1-128 symbology. (Also known as USS-128, GTIN-128, UCC-128.)

GS1-128 Enable

This option enables/disables the ability of the scanner to translate GS1-128 labels to the GS1-128 data format. Options are:

- Transmit GS1-128 labels in Code 128 data format.
- Transmit GS1-128 labels in GS1-128 data format.
- Do not transmit GS1-128 labels.



GS1-128 = Transmit in Code 128 data format

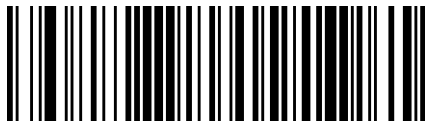

★ GS1-128 = Transmit in GS1-128 data format



GS1-128 = Do not transmit GS1-128 labels

INTERLEAVED 2 OF 5 (I 2 OF 5)

The following options apply to the I 2 of 5 symbology.



CAUTION: When reading this symbology, the settings for I 2 of 5 Length Control AND I 2 of 5 Check Character Calculation MUST be enabled to increase decoding safety.



I 2 of 5 Enable/Disable

When disabled, the scanner will not read I 2 of 5 bar codes.



★ I 2 of 5 = Disable



I 2 of 5 = Enable

I 2 of 5 Check Character Calculation

This option enables/disables calculation and verification of an optional I 2 of 5 check character.



★ I 2 of 5 Check Character Calculation = Disable



I 2 of 5 Check Character Calculation
= Calculate Std Check (Modulo 10 no AR)



I 2 of 5 Check Character Calculation
= Calculate German Parcel Check



I 2 of 5 Check Character Calculation
= Calculate DHL Check



I 2 of 5 Check Character Calculation
= Calculate Daimler Chrysler Check

I 2 of 5 Check Character Calculation (continued)



I 2 of 5 Check Character Calculation
= Calculate Bosch Check



I 2 of 5 Check Character Calculation
= Calculate Italian Post Check

I 2 of 5 Check Character Transmission

Enable this option to transmit the check character along with I 2 of 5 bar code data.



NOTE: This feature is valid only when I 2 of 5 Check Character Calculation is enabled.

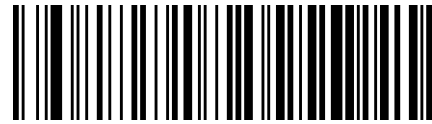

I 2 of 5 Check Character Transmission = Don't Send

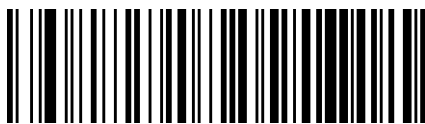

★ I 2 of 5 Check Character Transmission = Send

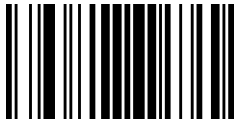

I 2 of 5 Length Control

This feature specifies either variable length decoding or fixed length decoding for the I 2 of 5 symbology.

Variable Length: For variable-length decoding, a minimum length may be set.

Fixed Length: For fixed-length decoding, two different lengths may be set.



★ I 2 of 5 Length Control = Variable Length

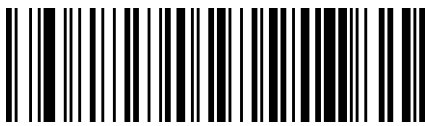

I 2 of 5 Length Control = Fixed Length

I 2 of 5 Set Length 1

This feature specifies one of the bar code lengths for "I 2 of 5 Length Control" on page 148. Length 1 is the minimum label length if in Variable Length Mode, or the first fixed length if in Fixed Length Mode. The length includes the bar code's check and data characters. The length can be set from 2 to 50 characters in increments of two. See "Set Length 1" on page 247 for more detailed programming instructions.



Select I 2 of 5 Set Length 1 Setting

To configure this feature, scan the ENTER/EXIT PROGRAMMING MODE bar code above, then the bar code at left followed by the digits from the Alphanumeric characters in Appendix D, Keypad representing your desired character(s). End by scanning the ENTER/EXIT bar code again.

Make a mistake? Scan the CANCEL bar code to abort and not save the entry string. You can then start again at the beginning.



CANCEL

★ Length 1 = 06 (6 characters)

I 2 of 5 Set Length 2

This feature specifies one of the bar code lengths for "I 2 of 5 Length Control" on page 148. Length 2 is the maximum label length if in Variable Length Mode, or the second fixed length if in Fixed Length Mode. The length includes the bar code's check and data characters. The length can be set from 2 to 50 characters in increments of two. A setting of 00 specifies to ignore this length (only one fixed length). See "Set Length 2" on page 248 for more detailed programming instructions.



To configure this feature, scan the ENTER/EXIT PROGRAMMING MODE bar code above, then the bar code at left followed by the digits from the Alphanumeric characters in Appendix D, Keypad representing your desired character(s). End by scanning the ENTER/EXIT bar code again.

Make a mistake? Scan the CANCEL bar code to abort and not save the entry string. You can then start again at the beginning.



★ Length 2 = 50 (50 characters)

INTERLEAVED 2 OF 5 CIP HR

The following options apply to the Interleaved 2 of 5 CIP HR symbology.

Interleaved 2 of 5 CIP HR Enable/Disable

Enables/Disables ability of the scanner to decode Interleaved 2 of 5 CIP HR labels.





STANDARD 2 OF 5

The following options apply to the Standard 2 of 5 symbology.

Standard 2 of 5 Enable/Disable

When disabled, the scanner will not read Standard 2 of 5 bar codes.



★ Standard 2 of 5 = Disable



Standard 2 of 5 = Enable

Standard 2 of 5 Check Character Calculation

This option enables/disables calculation and verification of an optional Standard 2 of 5 check character.



★ Standard 2 of 5 Check Character Calculation
= Disable



Standard 2 of 5 Check Character Calculation = Enable

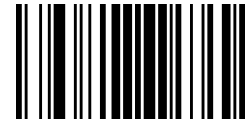

Standard 2 of 5 Check Character Transmission

This feature enables/disables transmission of an optional Standard 2 of 5 check character.

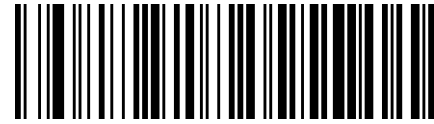

Standard 2 of 5 Check Character Transmission
= Don't Send



★ Standard 2 of 5 Check Character Transmission
= Send

Standard 2 of 5 Length Control

This feature specifies either variable length decoding or fixed length decoding for the Standard 2 of 5 symbology.

Variable Length: For variable-length decoding, a minimum length may be set.

Fixed Length: For fixed-length decoding, two different lengths may be set.



★ Standard 2 of 5 Length Control = Variable Length



Standard 2 of 5 Length Control = Fixed Length



Standard 2 of 5 Set Length 1

This feature specifies one of the bar code lengths for "Standard 2 of 5 Length Control" on [page 151](#). Length 1 is the minimum label length if in Variable Length Mode, or the first fixed length if in Fixed Length Mode. The length includes the bar code's check and data characters.

The length can be set from 1 to 50 characters. See "Set Length 1" on [page 247](#) for more detailed programming instructions.



Select Standard 2 of 5 Length 1 Setting

To configure this feature, scan the ENTER/EXIT PROGRAMMING MODE bar code above, then the bar code at left followed by the digits from the Alphanumeric characters in [Appendix D, Keypad](#) representing your desired character(s). End by scanning the ENTER/EXIT bar code again.

Make a mistake? Scan the CANCEL bar code to abort and not save the entry string. You can then start again at the beginning.



CANCEL

★ Length 1 = 08 (8 characters)

Standard 2 of 5 Set Length 2

This feature specifies one of the bar code lengths for "Standard 2 of 5 Length Control" on [page 151](#). Length 2 is the maximum label length if in Variable Length Mode, or the second fixed length if in Fixed Length Mode. The length includes the bar code's check and data characters.

The length can be set from 1 to 50 characters. A setting of 00 specifies to ignore this length (only one fixed length). See "Set Length 2" on [page 248](#) for more detailed programming instructions.

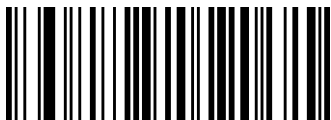

Select Standard 2 of 5 Set Length 2 Setting

To configure this feature, scan the ENTER/EXIT PROGRAMMING MODE bar code above, then the bar code at left followed by the digits from the Alphanumeric characters in [Appendix D, Keypad](#) representing your desired character(s). End by scanning the ENTER/EXIT bar code again.

Make a mistake? Scan the CANCEL bar code to abort and not save the entry string. You can then start again at the beginning.



CANCEL

★ Length 2 = 50 (50 characters)

COMPRESSED 2 OF 5

The following options apply to the Compressed 2 of 5 symbology.

Compressed 2 of 5 Enable/Disable

When disabled, the scanner will not read Compressed 2 of 5 bar codes.



★ Compressed 2 of 5 = Disable



Compressed 2 of 5 = Enable

Compressed 2 of 5 Check Character Calculation

This option enables/disables calculation and verification of an optional Compressed 2 of 5 check character.



★ Compressed 2 of 5 Check Character Calculation
= Disable



Compressed 2 of 5 Check Character Calculation = Enable



Compressed 2 of 5 Check Character Transmission

This feature enables/disables transmission of an optional Compressed 2 of 5 check character.



Compressed 2 of 5 Check Character Transmission
= Don't Send



★ Compressed 2 of 5 Check Character Transmission
= Send

Compressed 2 of 5 Length Control

This feature specifies either variable length decoding or fixed length decoding for the Compressed 2 of 5 symbology.

Variable Length: For variable-length decoding, a minimum length may be set.

Fixed Length: For fixed-length decoding, two different lengths may be set.



★ Compressed 2 of 5 Length Control = Variable
Length

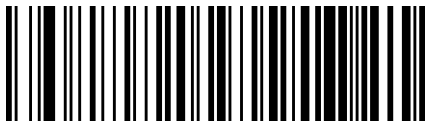

Compressed 2 of 5 Length Control = Fixed Length

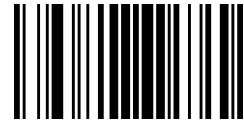

Compressed 2 of 5 Set Length 1

This feature specifies one of the bar code lengths for "Compressed 2 of 5 Length Control" on page 154. Length 1 is the minimum label length if in Variable Length Mode, or the first fixed length if in Fixed Length Mode. The length includes the bar code's check and data characters.

The length can be set from 1 to 50 characters. See "Set Length 1" on page 247 for more detailed programming instructions.

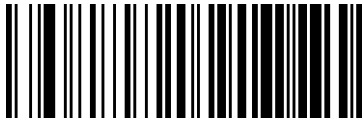

Select Compressed 2 of 5 Length 1 Setting

To configure this feature, scan the ENTER/EXIT PROGRAMMING MODE bar code above, then the bar code at left followed by the digits from the Alphanumeric characters in Appendix D, Keypad representing your desired character(s). End by scanning the ENTER/EXIT bar code again.

Make a mistake? Scan the CANCEL bar code to abort and not save the entry string. You can then start again at the beginning.

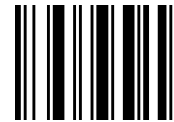

CANCEL

★ Length 1 = 01 (one character)

Compressed 2 of 5 Set Length 2

This feature specifies one of the bar code lengths for "Compressed 2 of 5 Length Control" on page 154. Length 2 is the maximum label length if in Variable Length Mode, or the second fixed length if in Fixed Length Mode. The length includes the bar code's check and data characters.

The length can be set from 1 to 50 characters. A setting of 00 specifies to ignore this length (only one fixed length). See "Set Length 2" on page 248 for more detailed programming instructions.



Select Compressed 2 of 5 Set Length 2 Setting

To configure this feature, scan the ENTER/EXIT PROGRAMMING MODE bar code above, then the bar code at left followed by the digits from the Alphanumeric characters in Appendix D, Keypad representing your desired character(s). End by scanning the ENTER/EXIT bar code again.

Make a mistake? Scan the CANCEL bar code to abort and not save the entry string. You can then start again at the beginning.



CANCEL

★ Length 2 = 50 (50 characters)

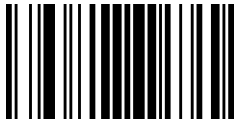

DATALOGIC 2 OF 5

The following options apply to the Datalogic 2 of 5 symbology.

Datalogic 2 of 5 Enable/Disable

When disabled, the scanner will not read Datalogic 2 of 5 bar codes.



★ Datalogic 2 of 5 = Disable

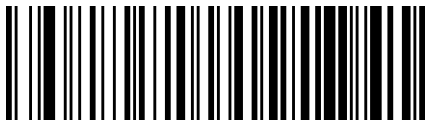

Datalogic 2 of 5 = Enable

Datalogic 2 of 5 Check Character Calculation

This option enables/disables calculation and verification of an optional Datalogic 2 of 5 check character.



★ Datalogic 2 of 5 Check Character Calculation
= Disable



Datalogic 2 of 5 Check Character Calculation = Enable

Datalogic 2 of 5 Check Character Transmission

Enable this option to transmit the check character along with Datalogic 2 of 5 bar code data.

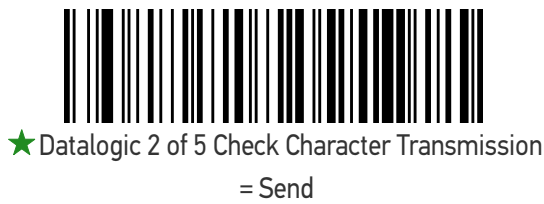

Datalogic 2 of 5 Length Control

This feature specifies either variable length decoding or fixed length decoding for the Datalogic 2 of 5 symbology.

Variable Length: For variable-length decoding, a minimum length may be set.

Fixed Length: For fixed-length decoding, two different lengths may be set.





Datalogic 2 of 5 Set Length 1

This feature specifies one of the bar code lengths for "Datalogic 2 of 5 Length Control" on page 157. Length 1 is the minimum label length if in Variable Length Mode, or the first fixed length if in Fixed Length Mode. The length includes the bar code's check and data characters. The length can be set from 2 to 50 characters in increments of two. See "Set Length 1" on page 247 for more detailed programming instructions.



Select Datalogic 2 of 5 Length 1 Setting

To configure this feature, scan the ENTER/EXIT PROGRAMMING MODE bar code above, then the bar code at left followed by the digits from the Alphanumeric characters in Appendix D, Keypad representing your desired character(s). End by scanning the ENTER/EXIT bar code again.

Make a mistake? Scan the CANCEL bar code to abort and not save the entry string. You can then start again at the beginning.



CANCEL

★ Length 1 = 06 (6 characters)

Datalogic 2 of 5 Set Length 2

This feature specifies one of the bar code lengths for "Datalogic 2 of 5 Length Control" on page 157. Length 2 is the maximum label length if in Variable Length Mode, or the second fixed length if in Fixed Length Mode. The length includes the bar code's check and data characters. The length can be set from 2 to 50 characters. A setting of 00 specifies to ignore this length (only one fixed length). See "Set Length 2" on page 248 for more detailed programming instructions.

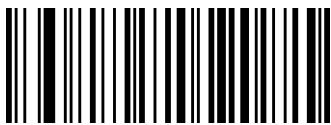

Select Datalogic 2 of 5 Set Length 2 Setting

To configure this feature, scan the ENTER/EXIT PROGRAMMING MODE bar code above, then the bar code at left followed by the digits from the Alphanumeric characters in Appendix D, Keypad representing your desired character(s). End by scanning the ENTER/EXIT bar code again.

Make a mistake? Scan the CANCEL bar code to abort and not save the entry string. You can then start again at the beginning.



CANCEL

★ Length 2 = 50 (50 characters)

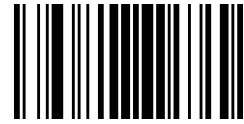

INDUSTRIAL 2 OF 5

The following options apply to the Industrial 2 of 5 symbology.

Industrial 2 of 5 Enable/Disable

When disabled, the scanner will not read Industrial 2 of 5 bar codes.



★ Industrial 2 of 5 = Disable



Industrial 2 of 5 = Enable

Industrial 2 of 5 Check Character Calculation

Enables/Disables calculation and verification of an optional Industrial 2 of 5 check character.



★ Industrial 2 of 5 Check Character Calculation
= Disable



Industrial 2 of 5 Check Character Calculation = Enable



Industrial 2 of 5 Check Character Transmission

Enables/disables transmission of an Industrial 2 of 5 check character.



Industrial 2 of 5 Check Character Transmission
= Don't Send



★ Industrial 2 of 5 Check Character Transmission
= Send

Industrial 2 of 5 Length Control

This feature specifies either variable length decoding or fixed length decoding for the Industrial 2 of 5 symbology.

Variable Length: For variable-length decoding, a minimum length may be set.

Fixed Length: For fixed-length decoding, two different lengths may be set.



★ Industrial 2 of 5 Length Control = Variable Length

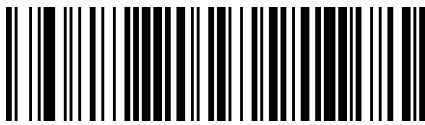

Industrial 2 of 5 Length Control = Fixed Length

Industrial 2 of 5 Set Length 1

This feature specifies one of the bar code lengths for "Industrial 2 of 5 Length Control" on [page 160](#). Length 1 is the minimum label length if in Variable Length Mode, or the first fixed length if in Fixed Length Mode. The length includes the bar code's check and data characters.

The length can be set from 1 to 50 characters. See "Set Length 1" on [page 247](#) for more detailed programming instructions.

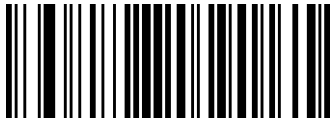

Select Industrial 2 of 5 Length 1 Setting

To configure this feature, scan the ENTER/EXIT PROGRAMMING MODE bar code above, then the bar code at left followed by the digits from the Alphanumeric characters in [Appendix D, Keypad](#) representing your desired character(s). End by scanning the ENTER/EXIT bar code again.

Make a mistake? Scan the CANCEL bar code to abort and not save the entry string. You can then start again at the beginning.



CANCEL

★ Length 1 = 06 (6 characters)

Industrial 2 of 5 Set Length 2

This feature specifies one of the bar code lengths for "Industrial 2 of 5 Length Control" on [page 160](#). Length 2 is the maximum label length if in Variable Length Mode, or the second fixed length if in Fixed Length Mode. The length includes the bar code's check and data characters.

The length can be set from 1 to 50 characters. A setting of 00 specifies to ignore this length (only one fixed length). See "Set Length 2" on [page 248](#) for more detailed programming instructions.

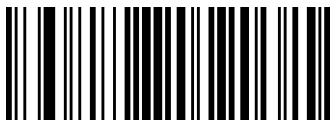

Select Industrial 2 of 5 Set Length 2 Setting

To configure this feature, scan the ENTER/EXIT PROGRAMMING MODE bar code above, then the bar code at left followed by the digits from the Alphanumeric characters in [Appendix D, Keypad](#) representing your desired character(s). End by scanning the ENTER/EXIT bar code again.

Make a mistake? Scan the CANCEL bar code to abort and not save the entry string. You can then start again at the beginning.



CANCEL

★ Length 2 = 50 (50 characters)



IATA

The following options apply to the IATA symbology.

IATA Enable/Disable

Enables/Disables the ability of the scanner to decode IATA labels.

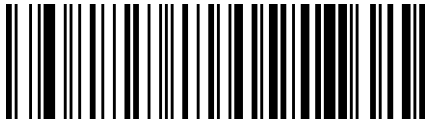

IATA = Enable



★ IATA = Disable

IATA Check Character Transmission

Enables/Disables calculation and verification of an optional IATA check character.

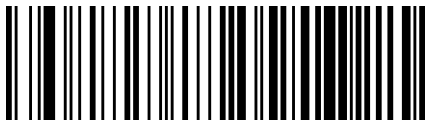

★ IATA Check Character Transmission
= Send



IATA Check Character Transmission
= Don't Send



FOLLETT 2 OF 5

The following options apply to the Follett 2 of 5 symbology.

Follett 2 of 5 Enable/Disable

Enables/Disables ability of scanner to decode Follett 2 of 5 labels.

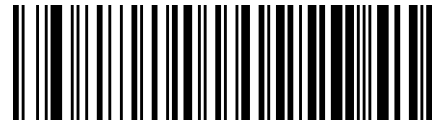

★ Follett 2 of 5 = Disable



Follett 2 of 5 = Enable

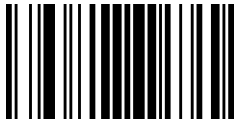

CODABAR

The following options apply to the Codabar symbology.

Codabar Enable/Disable

When disabled, the scanner will not read Codabar bar codes.



★ Codabar = Disable



Codabar = Enable

Codabar Check Character Calculation

This option enables/disables calculation and verification of an optional Codabar check character. When disabled, any check characters in the label are treated as data characters.



★ Codabar Check Character Calculation = Disable



Codabar Check Character Calculation
= Calculate AIM Std Check



Codabar Check Character Calculation
= Calculate Modulo 10 Check

Codabar Check Character Calculation
= Calculate NW-7 Check

Codabar Check Character Transmission

Enable this option to transmit the check character along with Codabar bar code data.



NOTE: This feature is valid only when Codabar Check Character Calculation is enabled.



Codabar Check Character Transmission
= Don't Send

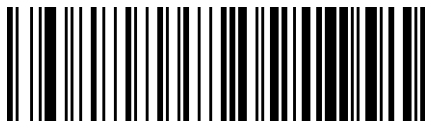

★ Codabar Check Character Transmission
= Send

Codabar Start/Stop Character Transmission

This option enables/disables transmission of Codabar start and stop characters.



Codabar Start/Stop Character Transmission
= Don't Transmit



★ Codabar Start/Stop Character Transmission
= Transmit



Codabar Start/Stop Character Set

This option specifies the format of transmitted Codabar start/stop characters.



Codabar Check Character Set = ABCD/TN*E

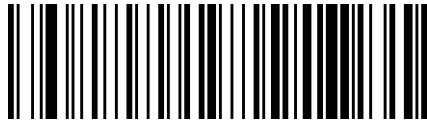

Codabar Check Character Set = ABCD/ABCD

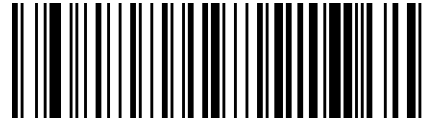

Codabar Check Character Set = abcd/tn*e

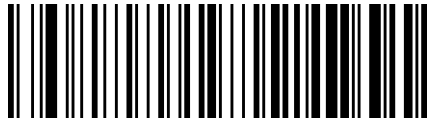

★ Codabar Check Character Set = abcd/abcd

Codabar Start/Stop Character Match

When enabled, this option requires that start and stop characters match



★ Codabar Start/Stop Character Match
= Don't Require Match



Codabar Start/Stop Character Match = Require Match

Codabar Quiet Zones

This feature specifies the number of quiet zones for Codabar labels. Quiet zones are blank areas at the ends of a bar code and are typically 10 times the width of the narrowest bar or space in the label.

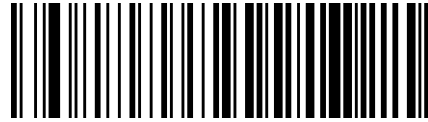

Codabar Quiet Zones = Quiet Zone on one side

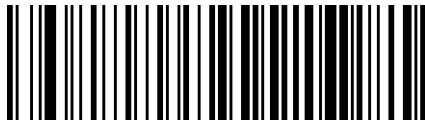

★ Codabar Quiet Zones = Quiet Zones on two sides

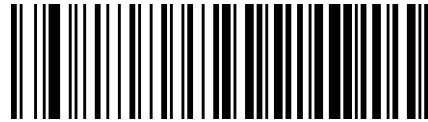

Codabar Quiet Zones = Auto



Codabar Quiet Zones = Virtual Quiet Zones on two sides

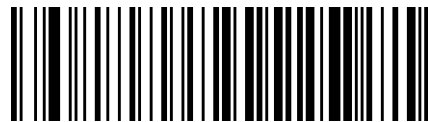

Codabar Quiet Zones = Small Quiet Zones on two sides



Codabar Length Control

This feature specifies either variable length decoding or fixed length decoding for the Codabar symbology.

Variable Length: For variable-length decoding, a minimum length may be set.

Fixed Length: For fixed-length decoding, two different lengths may be set.



★ Codabar Length Control = Variable Length

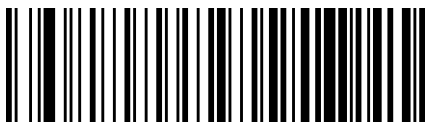

Codabar Length Control = Fixed Length

Codabar Set Length 1

This feature specifies one of the bar code lengths for "Codabar Length Control" on page 168. Length 1 is the minimum label length if in Variable Length Mode, or the first fixed length if in Fixed Length Mode. Length includes the bar code's start, stop, check and data characters. The length must include at least one data character.

The length can be set from 3 to 50 characters. See "Set Length 1" on page 247 for more detailed programming instructions.

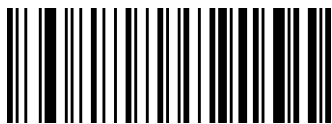

Select Codabar Length 1 Setting

To configure this feature, scan the ENTER/EXIT PROGRAMMING MODE bar code above, then the bar code at left followed by the digits from the Alphanumeric characters in Appendix D, Keypad representing your desired character(s). End by scanning the ENTER/EXIT bar code again.

Make a mistake? Scan the CANCEL bar code to abort and not save the entry string. You can then start again at the beginning.

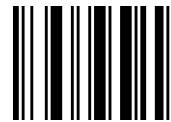

CANCEL

★ Length 1 = 03 (3 characters)

Codabar Set Length 2

This feature specifies one of the bar code lengths for "Codabar Length Control" on page 168. Length 2 is the maximum label length if in Variable Length Mode, or the second fixed length if in Fixed Length Mode. The length includes the bar code's start, stop, check and data characters. The length must include at least one data character.

The length can be set from 3 to 50 characters. A setting of 00 specifies to ignore this length (only one fixed length). See "Set Length 2" on page 248 for more detailed programming instructions.

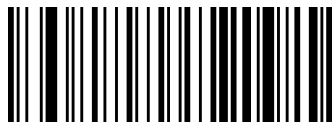

Select Codabar Length 2 Setting

To configure this feature, scan the ENTER/EXIT PROGRAMMING MODE bar code above, then the bar code at left followed by the digits from the Alphanumeric characters in [Appendix D, Keypad](#) representing your desired character(s). End by scanning the ENTER/EXIT bar code again.

Make a mistake? Scan the CANCEL bar code to abort and not save the entry string. You can then start again at the beginning.

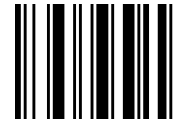

CANCEL

★ Length 2 = 50 (50 characters)



ABC CODABAR

The following options apply to the ABC Codabar symbology.

ABC Codabar Enable/Disable

Enables/Disables ability of scanner to decode ABC Codabar labels.



★ ABC Codabar = Disable

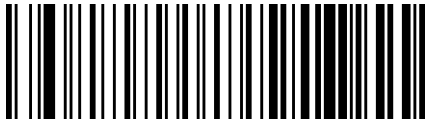

ABC Codabar = Enable

ABC Codabar Concatenation Mode

Specifies the concatenation mode between Static and Dynamic.

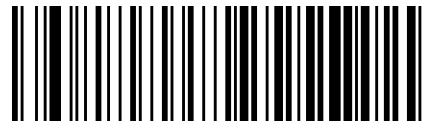

★ ABC Codabar Concatenation Mode = Static



ABC Codabar Concatenation Mode = Dynamic

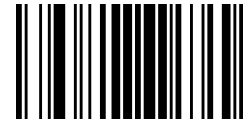

ABC Codabar Dynamic Concatenation Timeout

This parameter specifies the timeout in 10-millisecond ticks used by the ABC Codabar Dynamic Concatenation Mode. The timeout can be set within a range of 05 to 255 in 10ms increments. A setting of zero specifies no delay.



Select ABC Codabar Dynamic Concatenation
Timeout Setting

To configure this feature, scan the ENTER/EXIT PROGRAMMING MODE bar code above, then the bar code at left followed by the digits from the Alphanumeric characters in [Appendix D, Keypad](#) representing your desired character(s). End by scanning the ENTER/EXIT bar code again.

Make a mistake? Scan the CANCEL bar code to abort and not save the entry string. You can then start again at the beginning.

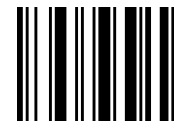

CANCEL

★ Timeout = 20 (200 ms)

ABC Codabar Force Concatenation

When ABC Codabar Concatenation is enabled and Force Concatenation is disabled, both Codabar stand alone labels and ABC Codabar concatenated labels are transmitted. When ABC Codabar Concatenation is enabled and Force Concatenation is enabled only ABC Codabar concatenated labels are transmitted while Codabar stand alone labels are not transmitted.

Force Concatenation has no effect if the ABC Codabar Concatenation is disabled. The Force Concatenation mode has effect both in Static and Dynamic Concatenation Modes.



★ ABC Codabar Force Concatenation = Disable



ABC Codabar Force Concatenation = Enable

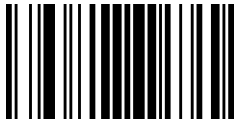

ISBT 128

The following options apply to the ISBT 128 symbology.

ISBT 128 Concatenation

Enables/disables ISBT 128 concatenation of 2 labels.



★ ISBT 128 Concatenation = Disable



ISBT 128 Concatenation = Enable

ISBT 128 Concatenation Mode

Specifies the concatenation mode between Static and Dynamic.

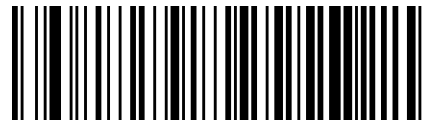

★ ISBT 128 Concatenation Mode = Static



ISBT 128 Concatenation Mode = Dynamic

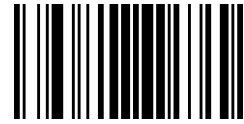

ISBT 128 Dynamic Concatenation Timeout

Specifies the timeout used by the ISBT 128 Dynamic Concatenation Mode.



ISBT 128 Dynamic Concatenation Timeout = 50 msec

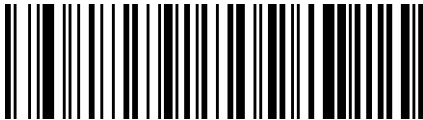

ISBT 128 Dynamic Concatenation Timeout = 100 msec



★ ISBT 128 Dynamic Concatenation Timeout = 200 msec



ISBT 128 Dynamic Concatenation Timeout = 500 msec



ISBT 128 Dynamic Concatenation Timeout = 750 msec



ISBT 128 Dynamic Concatenation Timeout = 1 second



ISBT 128 Force Concatenation

When enabled, this feature forces all ISBT 128 labels to be concatenated.



NOTE: This option is only valid when "ISBT 128 Concatenation" on page 172 is enabled.



★ ISBT 128 Force Concatenation = Disable

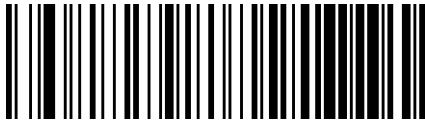

ISBT 128 Force Concatenation = Enable

ISBT 128 Advanced Concatenation Options



NOTE: Use the Datalogic Aladdin configuration application or Contact Customer Support to set up pairs of label types for concatenation.

CODE 11

The following options apply to the Code 11 symbology.

Code 11 Enable/Disable

When disabled, the scanner will not read Code 11 bar codes.



★ Code 11 = Disable

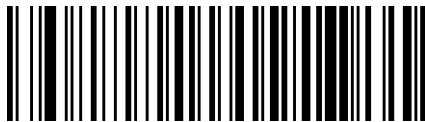

Code 11 = Enable

Code 11 Check Character Calculation

This option enables/disables calculation and verification of optional Code 11 check character.



Code 11 Check Character Calculation = Disable



Code 11 Check Character Calculation = Calculate Check C



Code 11 Check Character Calculation
= Calculate Check K



★ Code 11 Check Character Calculation
= Calculate Check C and K



Code 11 Check Character Transmission

This feature enables/disables transmission of an optional Code 11 check character.



Code 11 Check Character Transmission = Don't Send

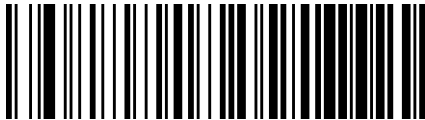

★ Code 11 Check Character Transmission = Send

Code 11 Length Control

This feature specifies either variable length decoding or fixed length decoding for the Code 11 symbology.

Variable Length: For variable-length decoding, a minimum length may be set.

Fixed Length: For fixed-length decoding, two different lengths may be set.



★ Code 11 Length Control = Variable Length



Code 11 Length Control = Fixed Length

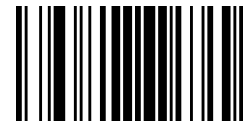

Code 11 Set Length 1

This feature specifies one of the bar code lengths for "Code 11 Length Control" on page 176. Length 1 is the minimum label length if in Variable Length Mode, or the first fixed length if in Fixed Length Mode. Length includes the bar code's check and data characters.

The length can be set from 2 to 50 characters. See "Set Length 1" on page 247 for more detailed programming instructions.

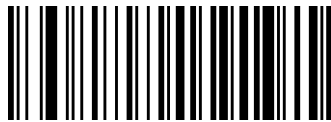

Select Code 11 Length 1 Setting

To configure this feature, scan the ENTER/EXIT PROGRAMMING MODE bar code above, then the bar code at left followed by the digits from the Alphanumeric characters in Appendix D, Keypad representing your desired character(s). End by scanning the ENTER/EXIT bar code again.

Make a mistake? Scan the CANCEL bar code to abort and not save the entry string. You can then start again at the beginning.



CANCEL

★ Length 1 = 04 (4 characters)

Code 11 Set Length 2

This feature specifies one of the bar code lengths for "Code 11 Length Control" on page 176. Length 2 is the maximum label length if in Variable Length Mode, or the second fixed length if in Fixed Length Mode. Length includes the bar code's check and data characters.

The length can be set from 2 to 50 characters. A setting of 00 specifies to ignore this length (only one fixed length). See "Set Length 2" on page 248 for more detailed programming instructions.



Select Code 11 Length 2 Setting

To configure this feature, scan the ENTER/EXIT PROGRAMMING MODE bar code above, then the bar code at left followed by the digits from the Alphanumeric characters in Appendix D, Keypad representing your desired character(s). End by scanning the ENTER/EXIT bar code again.

Make a mistake? Scan the CANCEL bar code to abort and not save the entry string. You can then start again at the beginning.



CANCEL

★ Length 2 = 50 (50 characters)



CODE 93

The following options apply to the Code 93 symbology.

Code 93 Enable/Disable

Enables/Disables ability of scanner to decode Code 93 labels.



★ Code 93 = Disable

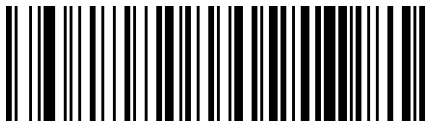

Code 93 = Enable

Code 93 Check Character Calculation

This option enables/disables calculation and verification of optional Code 93 check character.



Code 93 Check Character Calculation = Disable



Code 93 Check Character Calculation = Calculate Check C



Code 93 Check Character Calculation = Calculate Check K



★ Code 93 Check Character Calculation = Calculate Check C and K

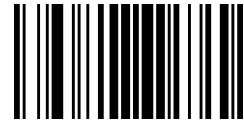

Code 93 Check Character Transmission

This feature enables/disables transmission of an optional Code 93 check character.



★ Code 93 Check Character Transmission = Don't
Send

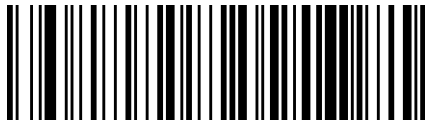

Code 93 Check Character Transmission = Send

Code 93 Length Control

This feature specifies either variable length decoding or fixed length decoding for the Code 93 symbology.

Variable Length: For variable-length decoding, a minimum length may be set.

Fixed Length: For fixed-length decoding, two different lengths may be set.



★ Code 93 Length Control = Variable Length



Code 93 Length Control = Fixed Length

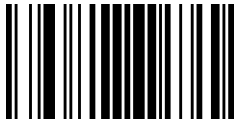

Code 93 Set Length 1

This feature specifies one of the bar code lengths for "Code 93 Length Control" on page 179. Length 1 is the minimum label length if in Variable Length Mode, or the first fixed length if in Fixed Length Mode. Length includes the bar code's check and data characters.

The length can be set from 1 to 50 characters. See "Set Length 1" on page 247 for more detailed programming instructions.

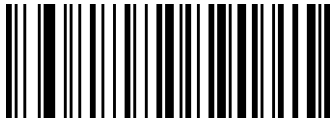

Select Code 93 Length 1 Setting

To configure this feature, scan the ENTER/EXIT PROGRAMMING MODE bar code above, then the bar code at left followed by the digits from the Alphanumeric characters in Appendix D, Keypad representing your desired character(s). End by scanning the ENTER/EXIT bar code again.

Make a mistake? Scan the CANCEL bar code to abort and not save the entry string. You can then start again at the beginning.

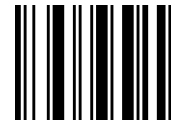

CANCEL

★ Length 1 = 01 (one character)

Code 93 Set Length 2

This feature specifies one of the bar code lengths for "Code 93 Length Control" on page 179. Length 2 is the maximum label length if in Variable Length Mode, or the second fixed length if in Fixed Length Mode. The length includes the bar code's check and data characters.

The length can be set from 1 to 50 characters. A setting of 00 specifies to ignore this length (only one fixed length). See "Set Length 2" on page 248 for more detailed programming instructions.



Select Code 93 Length 2 Setting

To configure this feature, scan the ENTER/EXIT PROGRAMMING MODE bar code above, then the bar code at left followed by the digits from the Alphanumeric characters in Appendix D, Keypad representing your desired character(s). End by scanning the ENTER/EXIT bar code again.

Make a mistake? Scan the CANCEL bar code to abort and not save the entry string. You can then start again at the beginning.



CANCEL

★ Length 2 = 50 (50 characters)

Code 93 Quiet Zones

This feature specifies the number of quiet zones for Code 93 labels. Quiet zones are blank areas at the ends of a bar code and are typically 10 times the width of the narrowest bar or space in the label.



Code 93 Quiet Zones = No Quiet Zones

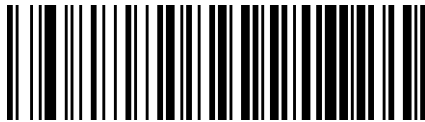

Code 93 Quiet Zones = Quiet Zone on one side



Code 93 Quiet Zones = Quiet Zones on two sides

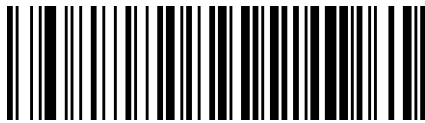

★ Code 93 Quiet Zones = Auto



Code 93 Quiet Zones = Virtual Quiet Zones on two sides



MSI

The following options apply to the MSI symbology.

MSI Enable/Disable

Enables/Disables ability of scanner to decode MSI labels.



★ MSI = Disable

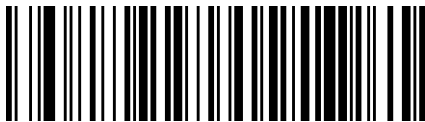

MSI = Enable

MSI Check Character Calculation

Enables/Disables calculation and verification of an optional MSI check character.



MSI Check Character Calculation = Disable



★ MSI Check Character Calculation = Calculate Mod 10



MSI Check Character Calculation
= Calculate Mod 11/10



MSI Check Character Calculation
= Calculate Mod 10/10

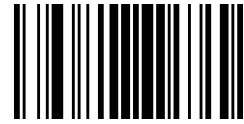

MSI Check Character Transmission

Enables/disables transmission of an MSI check character.



MSI Check Character Transmission = Don't Send

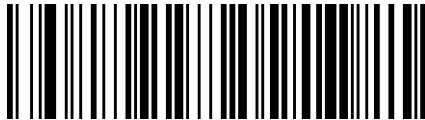

★ MSI Check Character Transmission = Send

MSI Length Control

This feature specifies either variable length decoding or fixed length decoding for the MSI symbology.

Variable Length: For variable-length decoding, a minimum length may be set.

Fixed Length: For fixed-length decoding, two different lengths may be set.



★ MSI Length Control = Variable Length



MSI Length Control = Fixed Length



MSI Set Length 1

This feature specifies one of the bar code lengths for "MSI Length Control" on page 183. Length 1 is the minimum label length if in Variable Length Mode, or the first fixed length if in Fixed Length Mode. Length includes the bar code's data characters only.

The length can be set from 1 to 50 characters. See "Set Length 1" on page 247 for more detailed programming instructions.



Select MSI Length 1 Setting

To configure this feature, scan the ENTER/EXIT PROGRAMMING MODE bar code above, then the bar code at left followed by the digits from the Alphanumeric characters in [Appendix D, Keypad](#) representing your desired character(s). End by scanning the ENTER/EXIT bar code again.

Make a mistake? Scan the CANCEL bar code to abort and not save the entry string. You can then start again at the beginning.



CANCEL

★ Length 1 = 01 (one character)

MSI Set Length 2

This feature specifies one of the bar code lengths for "MSI Length Control" on page 183. Length 2 is the maximum label length if in Variable Length Mode, or the second fixed length if in Fixed Length Mode. The length includes the bar code's data characters only.

The length can be set from 1 to 50 characters. A setting of 00 specifies to ignore this length (only one fixed length). See "Set Length 2" on page 248 for more detailed programming instructions.



Select MSI Length 2 Setting

To configure this feature, scan the ENTER/EXIT PROGRAMMING MODE bar code above, then the bar code at left followed by the digits from the Alphanumeric characters in [Appendix D, Keypad](#) representing your desired character(s). End by scanning the ENTER/EXIT bar code again.

Make a mistake? Scan the CANCEL bar code to abort and not save the entry string. You can then start again at the beginning.



CANCEL

★ Length 2 = 50 (50 characters)

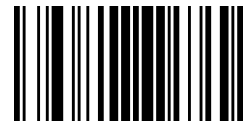

PLESSEY

The following options apply to the Plessey symbology.

Plessey Enable/Disable

Enables/Disables ability of scanner to decode Plessey labels.

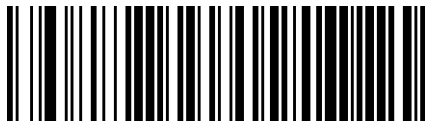

Plessey = Enable



★ Plessey = Disable

Plessey Check Character Calculation

Enables/Disables calculation and verification of a Plessey check character.



★ Plessey Check Character Calculation
= Plessey std check char. verification



Plessey Check Character Calculation = Disable



Plessey Check Character Calculation
= Anker check char. verification



Plessey Check Character Calculation
= Plessey std and Anker check char. verification



Plessey Check Character Transmission

Enables/disables transmission of a Plessey check character.



Plessey Check Character Transmission = Don't Send



★ Plessey Check Character Transmission = Send

Plessey Length Control

This feature specifies either variable length decoding or fixed length decoding for the Plessey symbology.

Variable Length: For variable-length decoding, a minimum length may be set.

Fixed Length: For fixed-length decoding, two different lengths may be set.



★ Plessey Length Control = Variable Length



Plessey Length Control = Fixed Length

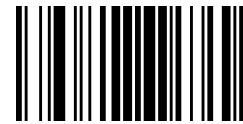

Plessey Set Length 1

This feature specifies one of the bar code lengths for "Plessey Length Control" on page 186. Length 1 is the minimum label length if in Variable Length Mode, or the first fixed length if in Fixed Length Mode. The length includes the bar code's check and data characters.

The length can be set from 1 to 50 characters. See "Set Length 1" on page 247 for more detailed programming instructions.

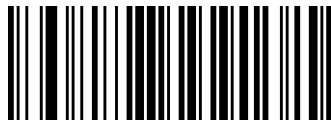

Select Plessey Length 1 Setting

To configure this feature, scan the ENTER/EXIT PROGRAMMING MODE bar code above, then the bar code at left followed by the digits from the Alphanumeric characters in Appendix D, Keypad representing your desired character(s). End by scanning the ENTER/EXIT bar code again.

Make a mistake? Scan the CANCEL bar code to abort and not save the entry string. You can then start again at the beginning.



CANCEL

★ Length 1 = 01 (one character)

Plessey Set Length 2

This feature specifies one of the bar code lengths for "Plessey Length Control" on page 186. Length 2 is the maximum label length if in Variable Length Mode, or the second fixed length if in Fixed Length Mode. The length includes the bar code's check and data characters.

Length can be set from 1 to 50 characters. A setting of 00 specifies to ignore this length (only one fixed length). See "Set Length 2" on page 248 for more detailed programming instructions.



Select Plessey Length 2 Setting

To configure this feature, scan the ENTER/EXIT PROGRAMMING MODE bar code above, then the bar code at left followed by the digits from the Alphanumeric characters in Appendix D, Keypad representing your desired character(s). End by scanning the ENTER/EXIT bar code again.

Make a mistake? Scan the CANCEL bar code to abort and not save the entry string. You can then start again at the beginning.



CANCEL

★ Length 2 = 50 (50 characters)

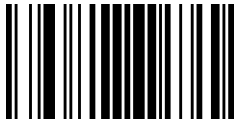

BC412

The following options apply to the BC412 symbology.

BC412 Enable/Disable

Enables/Disables ability of scanner to decode BC412 labels.



★ BC412 = Disable

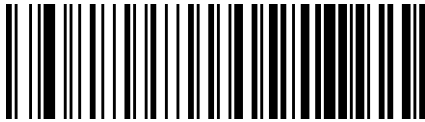

BC412 = Enable

BC412 Check Character Calculation

Enable this option to enable/disable calculation and verification of an optional BC412 check character. When disabled, any check character in the label is treated as a data character.



BC412 Check Character Calculation = Disable



★ BC412 Check Character Calculation = Calculate

BC412 Length Control

This feature specifies either variable length decoding or fixed length decoding for the BC412 symbology.

Variable Length: For variable-length decoding, a minimum length may be set.

Fixed Length: For fixed-length decoding, two different lengths may be set.

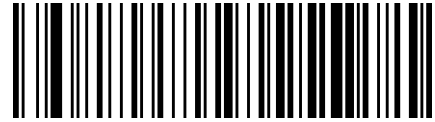

★ BC412 Length Control = Variable Length

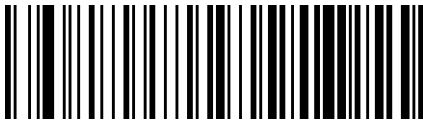

BC412 Length Control = Fixed Length



BC412 Set Length 1

This feature specifies one of the bar code lengths for "BC412 Length Control" on page 189. Length 1 is the minimum label length if in Variable Length Mode, or the first fixed length if in Fixed Length Mode. Length includes the bar code's data characters only.

The length can be set from 01 to 50 characters. See "Set Length 1" on page 247 for more detailed programming instructions.



Select BC412 Length 1 Setting

To configure this feature, scan the ENTER/EXIT PROGRAMMING MODE bar code above, then the bar code at left followed by the digits from the Alphanumeric characters in [Appendix D, Keypad](#) representing your desired character(s). End by scanning the ENTER/EXIT bar code again.

Make a mistake? Scan the CANCEL bar code to abort and not save the entry string. You can then start again at the beginning.



CANCEL

★ Length 1 = 01 (one character)

BC412 Set Length 2

This feature specifies one of the bar code lengths for "BC412 Length Control" on page 189. Length 2 is the maximum label length if in Variable Length Mode, or the second fixed length if in Fixed Length Mode. Length includes the bar code's data characters only.

The length can be set from 01 to 50 characters. A setting of 00 specifies to ignore this length (only one fixed length). See "Set Length 2" on page 248 for more detailed programming instructions.

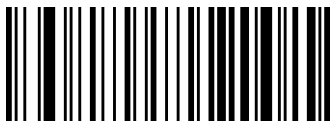

Select BC412 Length 2 Setting

To configure this feature, scan the ENTER/EXIT PROGRAMMING MODE bar code above, then the bar code at left followed by the digits from the Alphanumeric characters in [Appendix D, Keypad](#) representing your desired character(s). End by scanning the ENTER/EXIT bar code again.

Make a mistake? Scan the CANCEL bar code to abort and not save the entry string. You can then start again at the beginning.



CANCEL

★ Length 2 = 50 (50 characters)

CONFIGURATION | POWER MANAGEMENT

SECTION CONTENTS	
POWER SAVE starting on page 192	
•Powerdown Timeout	
BATTERY PROFILES starting on page 193	
•Battery Profiles	•Battery Information

These parameters refer to Mobile units only (either GBT4200 or GM4200 models).



POWER SAVE

Powerdown Timeout

The Powerdown Timeout feature sets the time for automatically switching the unit off when the imager has been idle.

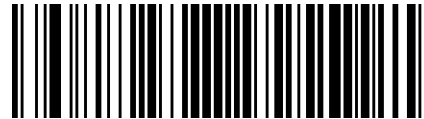

Powerdown Timeout = Disable



Powerdown Timeout = 10 minutes

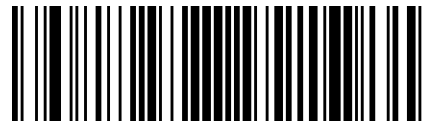

Powerdown Timeout = 20 minutes



Powerdown Timeout = 30 minutes

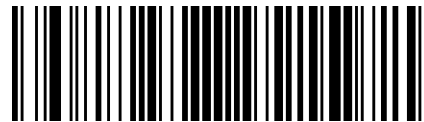

Powerdown Timeout = 60 minutes (1 hour)



Powerdown Timeout = 120 minutes (2 hours)

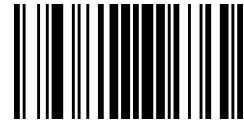

BATTERY PROFILES

Battery Profiles

Gryphon GBT/GM4200 provides the user the ability to select different usage profiles to better configure the reader with respect to specific needs. By default, the Maximum Performance profile is selected and provides high snappiness and max reading capability. The user can then decide to exploit specific features when others are considered less important, for instance: fast battery recharge instead of battery health, maximum reading performance instead of battery autonomy, etc.

The following Battery Profiles are described with associated benefits and limitations:

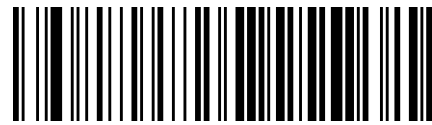

★ Battery Profile = Maximum Performance



Battery Profile = Maximum Battery Health

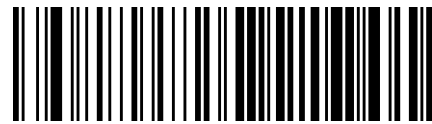

Battery Profile = Maximum Autonomy

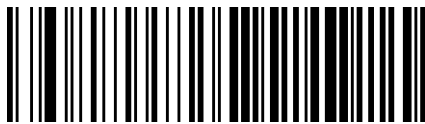

Battery Profile = Fast Charge



Maximum Performance (default)

- Scanner autonomy for heavy workload (80.000 scans for more than 22h)
- Motionix™ enabled
- Max radio communication performances



Maximum Battery Health

- Battery capacity is preserved
- Reduced max charging current
- Reduced battery capacity by ~20%
- Increased recharge time: +20% on average (it depends on the specific scanner configuration)



Maximum Autonomy

- Max scanner autonomy (approx. 83h)
- Motionix™ disabled
- Vibro motor disabled
- Reduced Radio Star™ responsiveness
- Increased Sniff-time period (Bluetooth®)



Fast Charge

- Reduced recharge time (approx. 20%)
- Motionix™ disabled
- Vibro motor disabled
- Scan-While-Charging disabled (Trigger Single)

Battery Information

By using Datalogic Aladdin utility, additional battery data can be retrieved, i.e.:

- HH Serial Number
- Charge %
- Health %
- Full Charge Capacity
- Designed Capacity
- Nominal Capacity
- Remaining Capacity
- Discharging Counter
- Charging Status
- Charging (Cradle) Battery Voltage
- Battery Current
- Manufacturer Date
- Battery Serial Number
- Battery Model Number

If more than one scanner is connected to a cradle, battery data will be retrieved for each scanner.

CONFIGURATION | WIRELESS FEATURES

SECTION CONTENTS	
WIRELESS BEEPER FEATURES starting on page 196	
<ul style="list-style-type: none"> • Good Transmission Beep • Beeper Frequency • Beep Duration • Beep Volume 	<ul style="list-style-type: none"> • Disconnect Beep • Docking (Connecting) Beep • Leash Alarm
CONFIGURATION UPDATES starting on page 201	
<ul style="list-style-type: none"> • Automatic Configuration Update • Copy Configuration to Scanner 	<ul style="list-style-type: none"> • Copy Configuration to Base Station
BATCH FEATURES starting on page 202	
<ul style="list-style-type: none"> • Batch Mode • Send Batch 	<ul style="list-style-type: none"> • Erase Batch Memory • Erase Batch Memory
DIRECT RADIO AUTOLINK starting on page 204	
<ul style="list-style-type: none"> • Direct Radio Autolink 	
RF ADDRESS STAMPING starting on page 205	
<ul style="list-style-type: none"> • RF Address Stamping 	<ul style="list-style-type: none"> • Source Radio Address Delimiter Character
BLUETOOTH-ONLY FEATURES starting on page 206	
<ul style="list-style-type: none"> • Bluetooth Security Level • Bluetooth Radio Output Power 	<ul style="list-style-type: none"> • Wi-Fi Channels Exclusion
BLUETOOTH HID FEATURES starting on page 213	
<ul style="list-style-type: none"> • Bluetooth HID Alt Mode 	
FEATURES FOR STAR MODELS ONLY starting on page 214	
<ul style="list-style-type: none"> • STAR Radio Protocol Timeout • STAR Radio Transmit Mode 	<ul style="list-style-type: none"> • STAR System Speed • STAR Frequency Agility

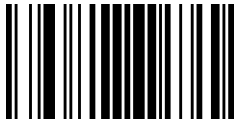

WIRELESS BEEPER FEATURES

Several options are available to configure beeper behavior for RF operation.

Good Transmission Beep

Enables/disables the Good Transmission Beep indication. When enabled, a beep occurs when a Label is correctly transmitted to the base.



Good Transmission Beep = Disable

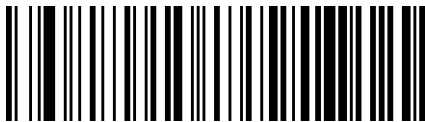

★ Good Transmission Beep = Enable

Beeper Frequency

Adjusts radio-specific beep indications to sound at a low, medium or high frequency, selectable from the list below (controls the beeper's pitch/tone).



★ Beeper Frequency = Low



Beeper Frequency = Medium



Beeper Frequency = High

Beep Duration

This feature controls the duration of radio-specific beep indications.

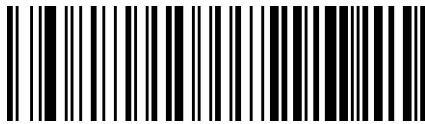

★ Beep Duration = 80 msec



Beep Duration = 60 msec

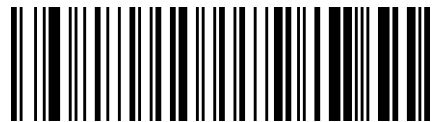

Beep Duration = 100 msec



Beep Duration = 120 msec



Beep Duration = 140 msec



Beep Duration = 160 msec



Beep Duration = 180 msec



Beep Duration = 200 msec



Beep Volume

Selects the beeper volume (loudness) of radio-specific beep indications. There are three selectable volume levels.



Beep Volume = Low

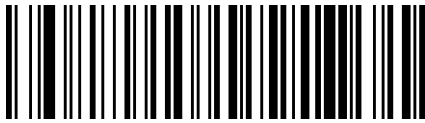

Beep Volume = Medium

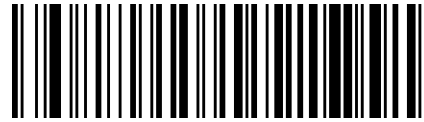

★ Beep Volume = High

Disconnect Beep

Enables/disables the beep indication that a handheld has become disconnected from a Base Station.

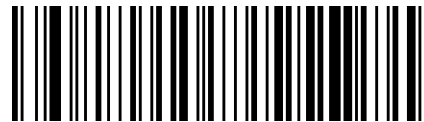

Disconnect Beep = Disable

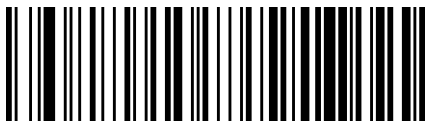

★ Disconnect Beep = Enable

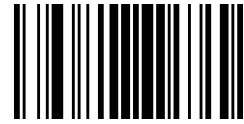

Docking (Connecting) Beep

Enables/disables a beep indication when the handheld is placed in the Base Station.

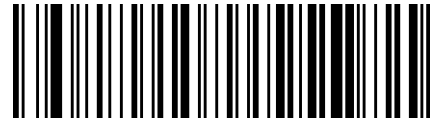

Docking Beep = Disable

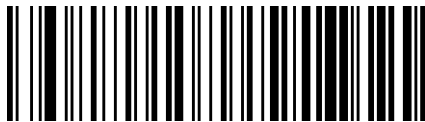

★ Docking Beep = Enable

Leash Alarm

This setting specifies the number of seconds to sound the Leash Mode beeps (three per second) when the handheld goes out of range. This is especially useful in instances where the reader might inadvertently have been placed in a bag or cart.

For this mode to be effective, the reader must be linked to the Base Station. If the reader is asleep or disconnected from the Base Station, there is no way for it to know where it is relative to the Base Station because communication is not active between the devices.



★ Leash Alarm = Disable



Leash Alarm = 1 Second



Leash Alarm = 2 Seconds



Leash Alarm = 3 Seconds



Leash Alarm (continued)

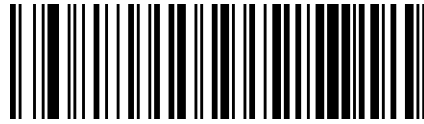

Leash Alarm = 4 Seconds

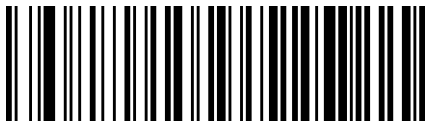

Leash Alarm = 5 Seconds

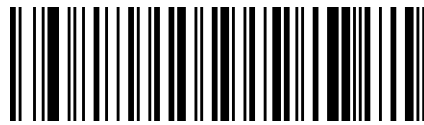

Leash Alarm = 10 Seconds



Leash Alarm = 25 Seconds

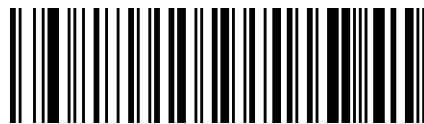

Leash Alarm = 30 Seconds

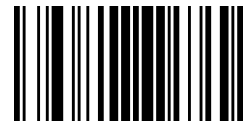

CONFIGURATION UPDATES

Automatic Configuration Update

When this feature is enabled, a reader and its linked Base Station can automatically ensure they stay in sync with regard to application hardware and/or configuration. See page 245 for more information on this feature.

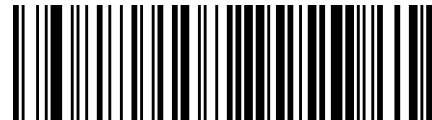

Automatic Configuration Update = Disable

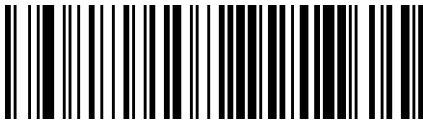

★ Automatic Configuration Update = Enable

Copy Configuration to Scanner

Scan the following label to copy the current Base Station configuration to the scanner. Use this method when the Auto Configuration Update feature is disabled and you want a one-time configuration update to be performed on the scanner.



NOTE: Do not scan an ENTER/EXIT PROGRAMMING MODE label in conjunction with this bar code.



Copy Configuration to Scanner

Copy Configuration to Base Station

Scan the following label to copy the current scanner configuration to the Base Station. Use this method when the Auto Configuration Update feature is disabled and you want a one-time configuration update to be performed on the Base Station.



NOTE: Do not scan an ENTER/EXIT PROGRAMMING MODE label in conjunction with this bar code.

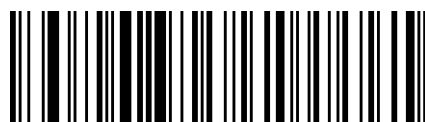

Copy Configuration to Base Station



BATCH FEATURES

Batch Mode

This option specifies whether to store labels in the handheld while disconnected from the base. Options are as follows:

- Disabled — The handheld will not store/batch labels.
- Automatic — The handheld will store labels to RAM when the handheld goes out of range and is disconnected from the remote device.
- Manual — The handheld will always store labels to Flash memory. The user must manually send the stored labels to the remote device using a special "batch send" label.



★ Batch Mode = Disable



Batch Mode = Automatic



Batch Mode = Manual

Send Batch

When the scanner is configured in Manual Batch Mode, use the following bar code to initiate sending of labels stored in batch memory.



NOTE: Do not scan an ENTER/EXIT PROGRAMMING MODE label in conjunction with this bar code.



Send Batch

BatchSend

Erase Batch Memory

When the scanner is configured in Manual Batch Mode, use the following bar code to erase any labels stored in batch memory.



NOTE: Do not scan an ENTER/EXIT PROGRAMMING MODE label in conjunction with this bar code.

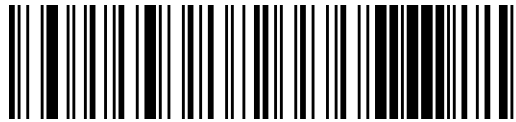

Erase Batch Memory

BatchClear

RF Batch Mode Transmit Delay

Specifies the delay in 10 msec increments between transmitting labels stored in batch memory.



★ RF Batch Mode Transmit Delay = No Delay



RF Batch Mode Transmit Delay = 50 ms



RF Batch Mode Transmit Delay = 100 ms



RF Batch Mode Transmit Delay = 0.5 seconds

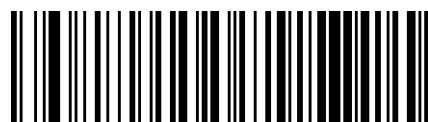

RF Batch Mode Transmit Delay = 1 second



RF Batch Mode Transmit Delay = 2.5 seconds

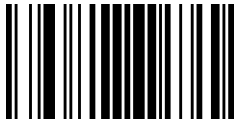

DIRECT RADIO AUTOLINK

Direct Radio Autolink

This feature enables/disables the ability to link a wireless handheld to a base station without scanning the Unlink label first.



★ Direct Radio Link = Unlink Label Required

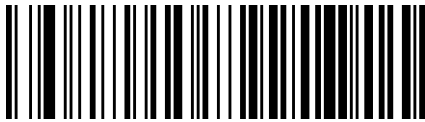

Direct Radio Link = Automatic Unlinking

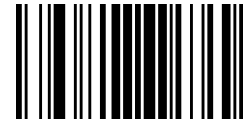

RF ADDRESS STAMPING

These features allow configuration of source radio data inclusion.

Source Radio Address Transmission

Enables/disables the ability of source radio address information to be transmitted to the host and, if so, at what position with respect to the label data. See [page 245](#) in “References” for detailed information and examples for setting this feature.



NOTE: When included as a prefix, the source-radio ID is displayed after all label formatting has been applied. The 6 byte hex address is sent as 12 ASCII characters, i.e., an address of 00 06 66 00 1A ED will be sent as (shown in hex): 30 30 30 36 36 36 30 30 31 41 45 44

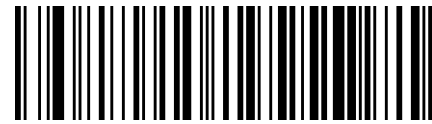

★ Source Radio Address Transmission =
Do Not Include

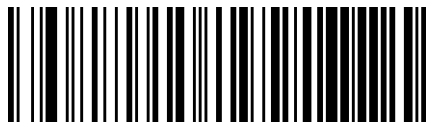

Source Radio Address Transmission = Prefix

Source Radio Address Delimiter Character

This option specifies the delimiter character to be placed between the label data and radio address when address stamping is enabled.



NOTE: This feature only applies if "Source Radio Address Transmission" on [page 205](#) is enabled.



Set Source Radio Address Delimiter Character

To configure this feature, scan the ENTER/EXIT PROGRAMMING MODE bar code above, then the bar code at left followed by the digits from the Alphanumeric characters in [Appendix D, Keypad](#) representing your desired character(s). End by scanning the ENTER/EXIT bar code again.

Make a mistake? Scan the CANCEL bar code to abort and not save the entry string. You can then start again at the beginning.

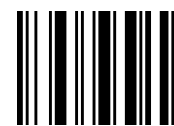

CANCEL

★ Delimiter Character = 00 (no delimiter character)



BLUETOOTH-ONLY FEATURES

The features in this section are valid only for Gryphon Bluetooth models.



NOTE: Changing the configuration parameters described in this section may cause a temporary loss of the Bluetooth connection between the Reader and the remote device.

Bluetooth Security Level



NOTE: This parameter applies when pairing the Reader with a third party Bluetooth device. It has no effect when linking the Reader to a Base station.

Set this parameter according to the security requirements of the application scenario when the reader will be employed.

- Select Level 1 - lowest when the main application requirement is to avoid any user interaction (e.g. Passkey or PIN entry) during the pairing process. When using this setting, the resulting Bluetooth connection will be encrypted but not authenticated.
- Select Level 2 when encryption is required, authentication is not required, and minimal user interaction is desired. In this case the Host may ask the user to enter a 6-digit Bluetooth Passkey during the pairing process.
- Select Level 3 - highest when a secure connection to the Host is desired, with both encryption and authentication. In this case the Host will ask the user to enter a 6-digit Bluetooth Passkey or a Bluetooth PIN during the pairing process.

If the Host prompts the user to enter a Bluetooth Passkey or PIN code during the pairing process, please refer to "Bluetooth Passkey or PIN Code Entry Request" on page 23 to perform this task.



NOTE: When device authentication takes place during the pairing process, by means of the passkey or PIN entry, the resulting Bluetooth link is protected from Man-In-The-Middle (MITM) malicious attacks.



NOTE: The actual behaviors of the Reader and of the Host system during the pairing process depend on the security settings of both devices involved, and on the input and output means available on each device to interface with the user.

This means that:

- the user may be required to enter a BT Passkey during the pairing process even if the reader's BT Security Level is set to "Encryption required, authentication not required". This depends on the configuration of the Host system.
- when the reader's BT Security Level is set to "Encryption and authentication required", it may not be possible to connect to a Host system if the latter cannot support the Passkey Entry authentication procedure. In this case, try to set the reader's BT Security Level to "Encryption required, authentication not required" to establish the connection.

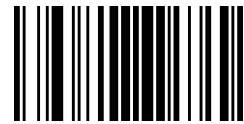

NOTE: Changing the BT Security Level setting will unlink the Reader from the remote device.

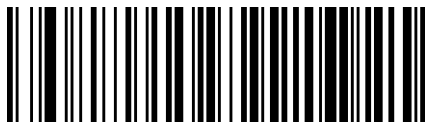

BT Security Level = Level 2

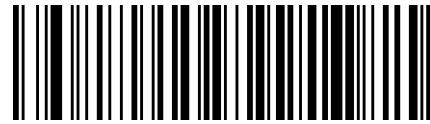

★ BT Security Level = Level 1 - lowest



BT Security Level = Level 3 - highest

Bluetooth Radio Output Power

Set this parameter according to the desired radio range of the Reader:

- Class 1: max 100 meters
- Class 2: max 20 meters
- Class 3: max 5 meters

Reducing the maximum radio range can help extend the battery life of the Reader and reduce the interferences caused to nearby wireless devices that operate in the same 2.4 GHz frequency band.



Bluetooth Output Power = Class 2



★ Bluetooth Output Power = Class 1 (highest)



Bluetooth Output Power = Class 3 (lowest)



Wi-Fi Channels Exclusion

In case the Reader operates in the same environment as 2.4 GHz Wi-Fi equipment, set this parameter to configure the strategy that the Reader should employ to minimize the interferences between Bluetooth and Wi-Fi wireless technologies.

- If the specific 802.11 standard or the frequency channels used by the Wi-Fi equipment are unknown, select Automatic to let the Reader use the Adaptive Frequency Hopping (AFH) feature of Bluetooth technology. With this setting, the Reader and the remote Bluetooth device may automatically detect the frequency channels affected by a significant level of interference, and avoid using these channels during Bluetooth data exchange.
- If the specific 802.11 standard and the frequency channels used by the Wi-Fi equipment are known, select the corresponding combination from the list of programming labels below or use the Datalogic Aladdin tool. With this setting, the Reader and the remote Bluetooth device avoid using the Bluetooth frequency channels that overlap with the already occupied Wi-Fi channels.

For example, if the co-located 2.4 GHz Wi-Fi equipment operates according to the 802.11g standard on channels n. 6 and n. 11, read the 802.11b/g ch.6 and 11 programming label.

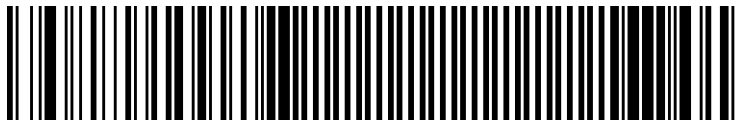

★ WiFi Ch. Exclusion = Automatic

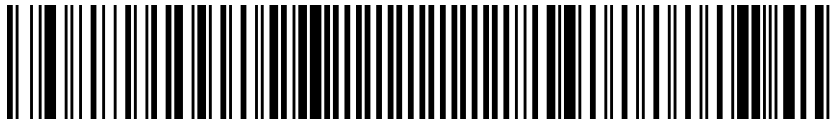

WiFi Ch. Exclusion = 802.11b_g ch.1

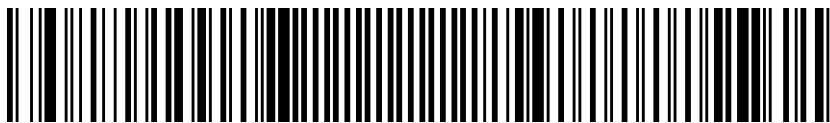

WiFi Ch. Exclusion = 802.11b_g ch.2

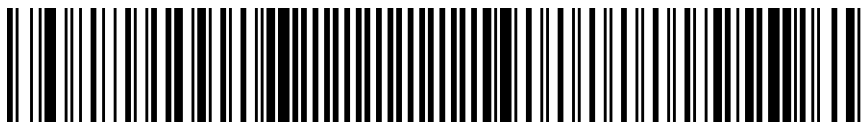

WiFi Ch. Exclusion = 802.11b_g ch.3

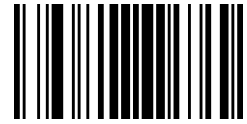

Wi-Fi Channels Exclusion (continued)



WiFi Ch. Exclusion = 802.11b_g ch.4



WiFi Ch. Exclusion = 802.11b_g ch.5



WiFi Ch. Exclusion = 802.11b_g ch.6

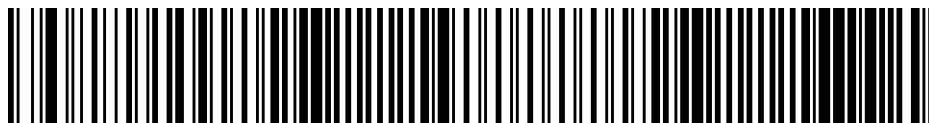

WiFi Ch. Exclusion = 802.11b_g ch.7

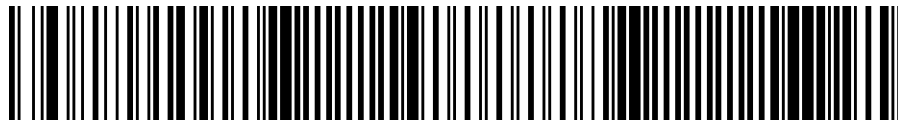

WiFi Ch. Exclusion = 802.11b_g ch.8



WiFi Ch. Exclusion = 802.11b_g ch.9



WiFi Ch. Exclusion = 802.11b_g ch.10



WiFi Ch. Exclusion = 802.11b_g ch.11



Wi-Fi Channels Exclusion (continued)



WiFi Ch. Exclusion = 802.11b_g ch.12

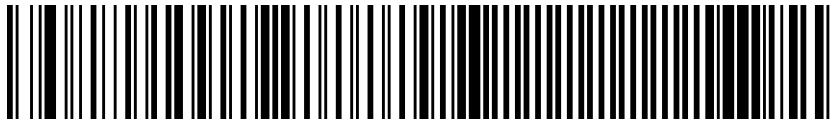

WiFi Ch. Exclusion = 802.11b_g ch.13

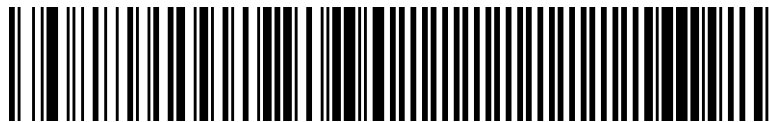

WiFi Ch. Exclusion = 802.11b_g ch.14

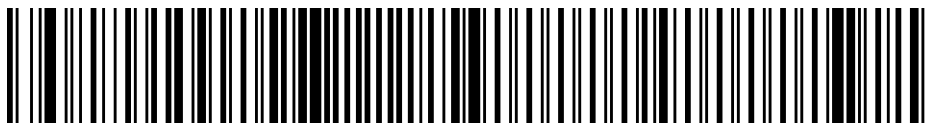

WiFi Ch. Exclusion = 802.11b_g ch.1 and 6

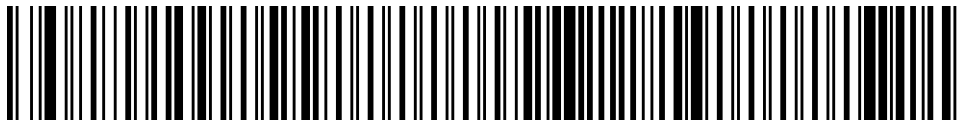

WiFi Ch. Exclusion = 802.11b_g ch.1 and 11



WiFi Ch. Exclusion = 802.11b_g ch.6 and 11



WiFi Ch. Exclusion = 802.11b_g ch.1 and 6 and 11



WiFi Ch. Exclusion = 802.11b_g ch.2 and 7

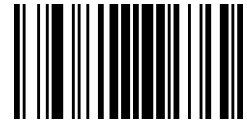

Wi-Fi Channels Exclusion (continued)

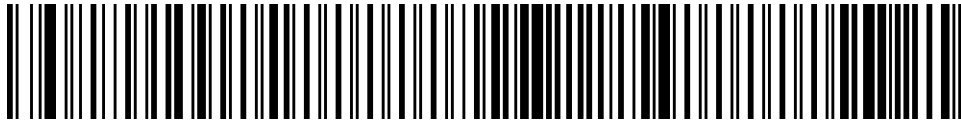

WiFi Ch. Exclusion = 802.11b_g ch.2 and 12

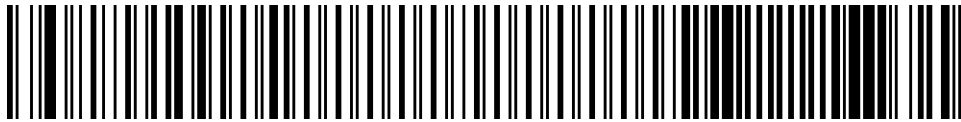

WiFi Ch. Exclusion = 802.11b_g ch.7 and 12



WiFi Ch. Exclusion = 802.11b_g ch.2 and 7 and 12



WiFi Ch. Exclusion = 802.11b_g ch.3 and 8

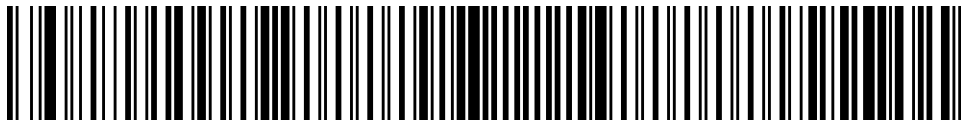

WiFi Ch. Exclusion = 802.11b_g ch.3 and 13

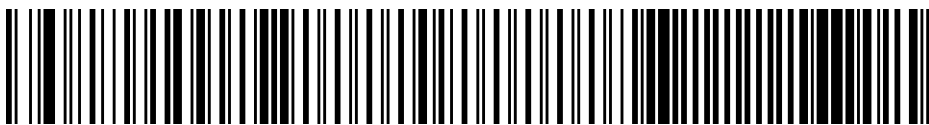

WiFi Ch. Exclusion = 802.11b_g ch.8 and 13



WiFi Ch. Exclusion = 802.11b_g ch.3 and 8 and 13

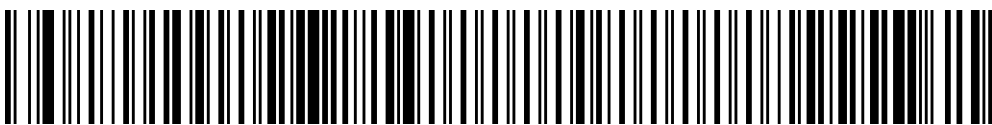

WiFi Ch. Exclusion = 802.11b_g ch.4 and 9

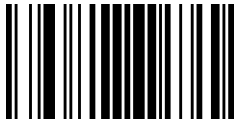

Wi-Fi Channels Exclusion (continued)

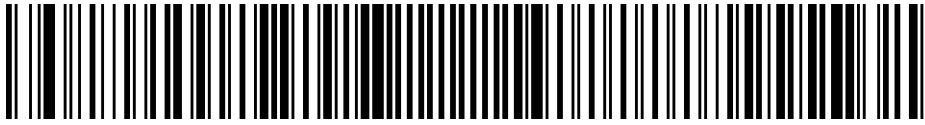

WiFi Ch. Exclusion = 802.11b_g ch.4 and 14

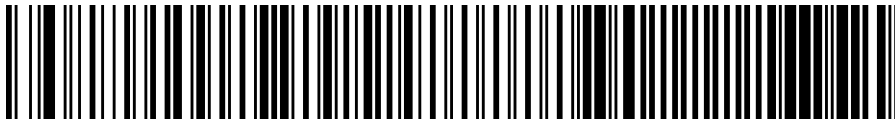

WiFi Ch. Exclusion = 802.11b_g ch.9 and 14

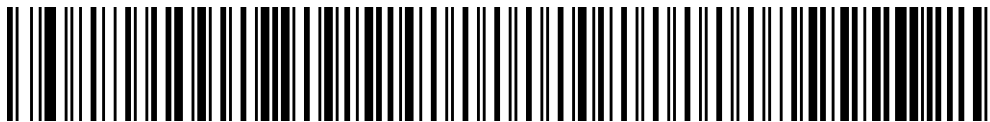

WiFi Ch. Exclusion = 802.11b_g ch.4 and 9 and 14

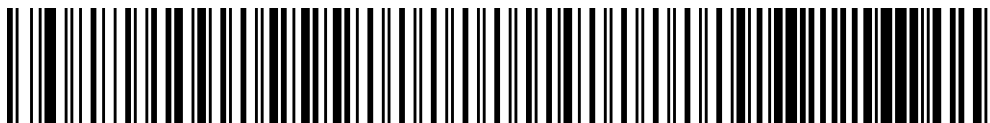

WiFi Ch. Exclusion = 802.11b_g ch.5 and 10



WiFi Ch. Exclusion = 802.11n ch.3



WiFi Ch. Exclusion = 802.11n ch.11

BLUETOOTH HID FEATURES

Before connecting the Reader to a Bluetooth HID host device, the keyboard emulation used for label transmission can be configured using the parameters described in this section, plus the following parameters:

- "Setting Country Mode" on page 49
- "Encoding Type" on page 63
- "ALT Output Type" on page 70
- "Keyboard Numeric Keypad" on page 72
- "Keyboard Send Control Characters" on page 72

Bluetooth HID Alt Mode

Enable/Disable the ability to correctly transmit a label to the host regardless of the Bluetooth HID Country Mode selected, when Bluetooth HID Profile is configured.

Read the configuration command label below for the HID Alt Mode feature.



★ HID Alt Mode = OFF



HID Alt Mode = ONF



FEATURES FOR STAR MODELS ONLY

The features in this section are valid only for the Gryphon I GM450X Star model:

- "STAR Radio Protocol Timeout" on page 214
- "STAR Radio Transmit Mode" on page 215

STAR Radio Protocol Timeout

This parameter sets the valid wait time before transmission between the handheld reader and Base Station is considered failed.

When setting this parameter, take into consideration the radio traffic (number of readers in the same area). The selectable range for this feature is from 02 to 25 seconds. See [page 246](#) in "References" for detailed information and examples for setting this feature.

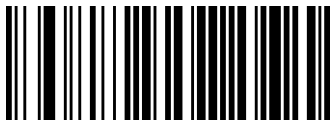

Set Radio Protocol Timeout

To configure this feature, scan the ENTER/EXIT PROGRAMMING MODE bar code above, then the bar code at left followed by the digits from the Alphanumeric characters in [Appendix D, Keypad](#) representing your desired character(s). End by scanning the ENTER/EXIT bar code again.

Make a mistake? Scan the CANCEL bar code to abort and not save the entry string. You can then start again at the beginning.

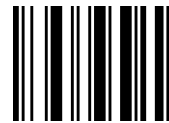

CANCEL

★ Radio Protocol Timeout = 02 (2 seconds)

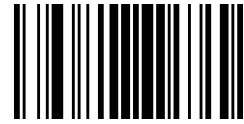

STAR Radio Transmit Mode

Specifies the transmission protocol for Star communications.

Options are:

- ACK from cradle to scanner — signals a good transmission as soon as the Base Station receives a label
- ACK when sent to host — scanner signals a good transmission as soon as the Base Station has sent the label to the host
- ACK from host — scanner signals a good transmission as soon as the Base Station has sent the label to the host and host has replied with an acknowledge message.

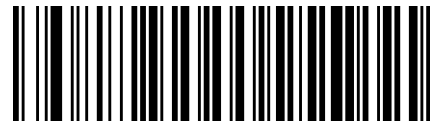

★ STAR Radio Transmit Mode =
ACK from Base Station

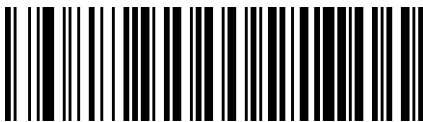

STAR Radio Transmit Mode = ACK When Sent to Host

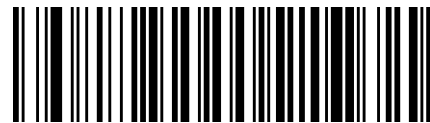

STAR Radio Transmit Mode = ACK from Host



NOTE: ACK from host works only for RS-232 or USB-COM interfaces with ACK/NACK disabled. If ACK from host is configured with any other interface conditions, it works like ACK when sent to host.

See “Message Formatting” on page 249. for details.



NOTE: The Base Station can receive a host message only if Host Commands Obey/Ignore (page 33) is set to Ignore.



STAR System Speed

By default, the Reader and the Base exchange data at high speed over the wireless communication channel. Reducing the speed from high to low, the radio range can be further extended. Moreover, when using low speed, the Reader can be configured to use the STAR Frequency Agility feature (see "STAR Frequency Agility" on page 217) also for the 433 MHz model (see Table 4 on page 218).

To change the STAR System Speed, follow this procedure:

1. link the Reader to the Base;
2. scan the ENTER/EXIT PROGRAMMING MODE bar code above; read either the "High speed" or "Low speed" programming label below to set the desired speed; end by scanning the ENTER/EXIT bar code again.
3. place the Reader into the Base.

The Reader and the Base will now be linked at the new programmed speed.

This feature can also be programmed using the Datalogic Aladdin tool:

1. set the STAR System Speed to "High speed" or "Low speed" through Aladdin;
2. place an unlinked Reader into the Base.

The Reader and the Base will link at the new programmed speed.



NOTE: Gryphon Star 433 MHz models do not support all combinations of STAR System Speed and STAR Frequency Agility (see "STAR Frequency Agility" on page 217) configuration parameters. Please refer to Table 4 on page 218 for the allowed combinations.



★ STAR System Speed = High Speed



STAR System Speed = Low Speed

STAR Frequency Agility

In exceptionally noisy environments or in case of a high concentration of radio devices, the STAR system performance may be improved by enabling the STAR Frequency Agility feature. This feature changes the way the radio frequencies are used in a STAR communication system.

As in the case of the STAR System Speed, use the following procedure:

1. link the Reader to the Base;
2. scan the ENTER/EXIT PROGRAMMING MODE bar code above; read either the “Enable” or “Disable” programming label below to Enable or Disable the feature; end by scanning the ENTER/EXIT bar code again.
3. place the Reader into the Base.

The Reader and the Base will be linked and the new frequency handling strategy will be operational.



NOTE: It is possible to configure the STAR system to use a fixed channel with different frequency from the default one. Please contact Datalogic Technical Support for information about this feature. Please refer to Table 4 on page 218 for valid combinations of this feature with the STAR System Speed configuration parameter.



NOTE: Gryphon Star 433 MHz models do not support all combinations of STAR Frequency Agility and STAR System Speed (see "STAR System Speed" on page 216) configuration parameters. Please refer to Table 4 on page 218 for the allowed combinations.



★ STAR Frequency Agility = Disable
(use default fixed channel)



STAR Frequency Agility = Enable



Table 4 Supported combinations of STAR System Speed and STAR Frequency Agility configuration parameters

SYSTEM SPEED	FREQUENCY AGILITY	FIXED CHANNEL DIFFERENT FROM DEFAULT
433 MHz Model		
Low Speed	Yes	Yes
High Speed	No	No
910 MHz Model		
Low Speed	Yes	Yes
High Speed	Yes	Yes

CHAPTER 4

REFERENCES

This section contains explanations and examples of selected bar code features. See [Configuration with Bar Codes](#), starting on page 31 for the actual bar code labels used to configure the scanner.

SECTION CONTENTS	
RS-232 PARAMETERS on page 220	
<ul style="list-style-type: none"> Baud Rate Data Bits Stop Bits 	<ul style="list-style-type: none"> Parity Handshaking Control
RS-232/USB COM PARAMETERS on page 221	
<ul style="list-style-type: none"> Intercharacter Delay ACK NAK Options ACK Character NAK Character 	<ul style="list-style-type: none"> ACK NAK Timeout Value ACK NAK Retry Count Disable Character Enable Character
KEYBOARD INTERFACE on page 228	
<ul style="list-style-type: none"> Wedge Quiet Interval Intercharacter Delay 	<ul style="list-style-type: none"> Intercode Delay
DATA FORMAT on page 231	
<ul style="list-style-type: none"> Data Editing Global Prefix/Suffix Global AIM ID 	<ul style="list-style-type: none"> Label ID Character Conversion
SCANNING FEATURES on page 239	
<ul style="list-style-type: none"> Good Read LED Duration Scan Mode Scanning Active Time 	<ul style="list-style-type: none"> Aiming Duration Time Flash On Time Flash Off Time
RF FEATURES on page 245	
<ul style="list-style-type: none"> Automatic Configuration Update RF Address Stamping 	<ul style="list-style-type: none"> STAR Radio Protocol Timeout
SYMBOLOGIES on page 247	
<ul style="list-style-type: none"> Set Length 	

RS-232 PARAMETERS

RS-232 ONLY

Baud Rate

Baud rate is the number of bits of data transmitted per second. Set the scanner's baud rate to match the baud rate setting of the host device. With an improper baud rate setting, data may not reach the host correctly.

Data Bits

This parameter allows the reader to interface with devices requiring a 7-bit or 8-bit ASCII protocol for sending and receiving data.

Stop Bits

The stop bit(s) at the end of each transmitted character marks the end of transmission of one character and prepares the receiving device for the next character in the serial data stream. The number of stop bits selected (one or two) depends on the number the receiving terminal is programmed to accommodate. Set the number of stop bits to match host device requirements.

Parity

This feature specifies parity required for sending and receiving data. A parity check bit is the most significant bit of each ASCII coded character. Select the parity type according to host device requirements.

- Select None when no parity bit is required.
- Select Odd parity and the parity bit value is set to 0 or 1, based on data, to ensure that an odd number of 1 bits are contained in the coded character.
- Select Even parity and the parity bit value is set to 0 or 1, based on data, to ensure that an even number of 1 bits are contained in the coded character.

Handshaking Control

The data interface consists of an RS-232 port designed to operate either with or without the hardware handshaking lines, Request to Send (RTS), and Clear to Send (CTS). Handshaking Control includes the following options:

- RTS — RTS is asserted during transmissions. CTS is ignored.
- RTS/CTS — RTS is asserted during transmissions. CTS gates transmissions.
- RTS/XON/XOFF — RTS is asserted during transmissions. CTS is ignored. XON and XOFF gate transmissions.
- RTS On/CTS — RTS is always asserted. CTS gates transmissions.
- RTS/CTS Scan Control — RTS is asserted during transmissions. CTS gates transmissions and controls enable and disable state of scanner.

RS-232/USB COM PARAMETERS

Intercharacter Delay

This parameter specifies the intercharacter delay between the end of one character and the beginning of the next. The delay can be set within a range of zero (0) to 990 milliseconds in 10ms increments. A setting of zero specifies no delay.

To set the delay:

1. Determine the desired setting in milliseconds.
2. Divide the desired setting by 10 (setting is in 10ms increments). Pad the result with leading zeroes to yield two digits. For example: 0 = 00, 5 = 05, 20 = 20, etc.
3. Scan the ENTER/EXIT PROGRAMMING MODE bar code to enter Programming Mode.
4. Go to [page 40](#) and scan the bar code: SELECT INTERCHARACTER DELAY SETTING.
5. Scan the appropriate two digits from the keypad in [Appendix D](#), that represent the duration which was determined in the steps above. You will hear a two-beep indication after the last character.



NOTE: If you make a mistake before the last character, scan the CANCEL bar code to abort and not save the entry string. You can then start again at the beginning.

6. Scan the ENTER/EXIT PROGRAMMING MODE bar code to exit.

This completes the procedure. See the following table for examples of how to set this feature.

Table 5 - Intercharacter Delay Setting Examples

STEP	ACTION	EXAMPLES			
1	Desired Setting	50ms	150ms	600ms	850ms
2	Divide by 10 (pad with leading zeroes to yield two-digits)	05	10	60	85
3	Scan ENTER/EXIT PROGRAMMING MODE				
4	Scan SELECT INTERCHARACTER DELAY SETTING				
5	Scan two characters from Appendix D	'0' and '5'	'1' and '5'	'6' and '0'	'8' and '5'
6	Scan ENTER/EXIT PROGRAMMING MODE				

ACK NAK Options

This enables/disables the ability of the scanner to support the RS-232 ACK/NAK protocol. When configured, the scanner and/or host sends an “ACK” when it receives data properly, and sends “NAK” when the data is in error.

Options are:

- Disable
- Enable for label transmission — The scanner expects an ACK/NAK response from the host when a label is sent
- Enable for host-command acknowledge — The scanner will respond with ACK/NAK when the host sends a command
- Enable for label transmission and host-command acknowledge

ACK Character

This setting specifies an ASCII character or hex value to be used as the ACK character. ASCII characters or any hex value from 0 to 0xFF can be selected.



NOTE: Setting to previously defined characters such as XON, XOFF, or host commands conflicts with normal operation of these characters. 8-bit data is not recognized when the option Data Bits page 43 has been set as 7 Data Bits.

1. Determine the desired character or value.
2. Use the ASCII Chart on [page 288](#) to find the hex equivalent for the desired character/value.
3. Scan ENTER/EXIT PROGRAMMING MODE to enter Programming Mode.
4. Scan the bar code: SELECT ACK CHARACTER SETTING.
5. Scan the appropriate two alphanumeric characters from the keypad in [Appendix D](#), that represent the desired character/value determined above. The second character will cause a two-beep indication.
6. Scan the ENTER/EXIT PROGRAMMING MODE bar code to exit.

See the table below for examples of how to set this feature.

Table 6 - ACK Character Setting Examples

STEP	ACTION	EXAMPLES			
1	Desired Character/Value	ACK	\$	@	>
2	Hex equivalent from ASCII Chart on page 288	0x06	0x24	0x40	0x3E
3	Scan ENTER/EXIT PROGRAMMING MODE				
4	Scan SELECT ACK CHARACTER SETTING				
5	Scan two characters from Appendix D	'0' and '6'	'2' and '4'	'4' and '0'	'3' AND 'E'
6	Scan ENTER/EXIT PROGRAMMING MODE				

NAK Character

This setting specifies an ASCII character or hex value to be used as the NAK character. ASCII characters or any hex value from 0 to 0xFF can be selected.



NOTE: Setting to previously defined characters such as XON, XOFF, or host commands conflicts with normal operation of these characters. 8-bit data is not recognized when the option Data Bits on page 43 has been set as 7 Data Bits.

To set this feature:

1. Determine the desired character or value.
2. Use the ASCII Chart on [page 288](#) to find the hex equivalent for the desired character/value.
3. Scan the ENTER/EXIT PROGRAMMING MODE bar code to enter Programming Mode.
4. Scan the bar code: SELECT NAK CHARACTER SETTING.
5. Scan the appropriate two alpha-numeric characters from the keypad in [Appendix D](#), that represent the desired character/value determined above. The second character will cause a two-beep indication.
6. Scan the ENTER/EXIT PROGRAMMING MODE bar code to exit Programming Mode.

This completes the procedure. See the table below for examples of how to set this feature.

Table 7 - NAK Character Setting Examples

STEP	ACTION	EXAMPLES			
1	Desired Character/Value	NAK	\$	@	>
2	Hex equivalent	0x15	0x24	0x40	0x3E
3	Scan ENTER/EXIT PROGRAMMING MODE				
4	Scan SELECT NAK CHARACTER SETTING				
5	Scan two characters from Appendix D	'1' and '5'	'2' and '4'	'4' and '0'	'3' AND 'E'
6	Scan ENTER/EXIT PROGRAMMING MODE				

ACK NAK Timeout Value

This option specifies the amount of time the scanner waits for an ACK character from the host following label transmission. The selectable timeout range is 200 milliseconds to 15,000ms (15 seconds) in 200ms increments. A selection of 0 disables the timeout.

To set this value:

1. Determine the desired setting in milliseconds.
2. Divide the desired setting by 200 (setting is in 200ms increments). Pad the result with leading zeroes to yield two digits. For example: 0 = 00, 5 = 05, 20 = 20, etc.
3. Scan the ENTER/EXIT PROGRAMMING MODE bar code to enter Programming Mode.
4. Scan the bar code: SELECT ACK NAK TIMEOUT VALUE SETTING.
5. Scan the appropriate two digits from the keypad in [Appendix D](#), that represent the duration which was determined in the steps above. You will hear a two-beep indication after the last character.



NOTE: If you make a mistake before the last character, scan the CANCEL bar code to abort and not save the entry string. You can then start again at the beginning.

6. Scan the ENTER/EXIT PROGRAMMING MODE bar code to exit Programming Mode.

This completes the procedure. See the table below for examples of how to set this feature.

Table 8 - ACK NAK Timeout Value Setting Examples

STEP	ACTION	EXAMPLES			
1	Desired Setting	200ms	1,000ms (1 sec.)	5200ms (5.2 sec.)	15,000ms (15 sec.)
2	Divide by 200	01	05	26	75
3	Scan ENTER/EXIT PROGRAMMING MODE				
4	Scan SELECT ACK NAK TIMEOUT VALUE SETTING				
5	Scan two characters from Appendix D	'0' and '1'	'0' and '5'	'2' and '6'	'7' AND '5'
6	Scan ENTER/EXIT PROGRAMMING MODE				

ACK NAK Retry Count

This feature specifies the number of times the scanner retries a label transmission due to a retry condition. The selectable range is from 1 to 254 retries. A selection of 0 disables the count, and a selection of 255 specifies unlimited retries.

To set this feature:

1. Determine the desired setting.
2. Pad the number with leading zeroes to yield three digits. For example: 0 = 000, 5 = 005, 20 = 020, etc.
3. Scan the ENTER/EXIT PROGRAMMING MODE bar code to enter Programming Mode.
4. Scan the bar code: SELECT ACK NAK RETRY COUNT SETTING.
5. Scan the appropriate three digits from the keypad in [Appendix D](#), that represent the number which was determined in the steps above. You will hear a two-beep indication after the last character.



NOTE: If you make a mistake before the last character, scan the CANCEL bar code to abort and not save the entry string. You can then start again at the beginning.

6. Scan the ENTER/EXIT PROGRAMMING MODE bar code to exit Programming Mode.

This completes the procedure. See the table below for examples of how to set this feature.

Table 9 - ACK NAK Retry Count Setting Examples

STEP	ACTION	EXAMPLES			
1	Desired Setting	Disable Retry Count	3 Retries	54 Retries	Unlimited Retries
2	Pad with leading zero(es)	000	003	054	255
3	Scan ENTER/EXIT PROGRAMMING MODE				
4	Scan SELECT ACK NAK RETRY COUNT SETTING				
5	Scan three characters from Appendix D	'0', '0' and '0'	'0', '0' and '3'	'0', '5' and '4'	'2', '5' and '5'
6	Scan ENTER/EXIT PROGRAMMING MODE				

Disable Character

Specifies the value of the RS-232 host command used to disable the scanner.
 ASCII characters or any hex value from 0 to 0xFF can be selected.



NOTE: Setting to previously defined characters such as XON, XOFF, or host commands conflicts with normal operation of these characters. 8-bit data is not recognized when the option "Data Bits" on page 36 has been set as 7 Data Bits.

To set the value:

1. Determine the desired character or value. A setting of 0xFF indicates the Disable Character is not used (not available).
2. Use the ASCII Chart on [page 288](#) to find the hex equivalent for the desired character/value.
3. Scan the ENTER/EXIT PROGRAMMING MODE bar code to enter Programming Mode.
4. Scan the bar code: SELECT DISABLE CHARACTER SETTING on [page 46](#).
5. Scan the appropriate two alphanumeric characters from the keypad in [Appendix D](#), that represent the desired character/value determined above. The second character will cause a two-beep indication.
6. Scan the ENTER/EXIT PROGRAMMING MODE bar code to exit Programming Mode.

This completes the procedure. See the table below for examples of how to set this feature.

Table 10 -Disable Character Setting Examples

STEP	ACTION	EXAMPLES			
1	Desired character/value	'd'	'j'	'D'	Disable Command Not Used
2	Hex equivalent from ASCII Chart on page 288	0x64	0x7D	0x44	0xFF
3	Scan ENTER/EXIT PROGRAMMING MODE				
4	Scan SELECT DISABLE CHARACTER VALUE SETTING				
5	Scan three characters from Appendix D	'6' and '4'	'7' and 'D'	'4' and '4'	'F' and 'F'
6	Scan ENTER/EXIT PROGRAMMING MODE				

Enable Character

Specifies the value of the RS-232 host command used to enable the scanner.

ASCII characters or any hex value from 0 to 0xFF can be selected.



NOTE: Setting to previously defined characters such as XON, XOFF, or host commands conflicts with normal operation of these characters. 8-bit data is not recognized when the option "Data Bits" on page 36 has been set as 7 Data Bits.

To set the value:

1. Determine the desired character or value. A setting of 0xFF indicates the Enable Character is not used (not available).
2. Use the ASCII Chart in [Appendix F](#) to find the hex equivalent for the desired character/value.
3. Scan the ENTER/EXIT PROGRAMMING MODE bar code to enter Programming Mode.
4. Scan the bar code: SELECT ENABLE CHARACTER SETTING on [page 46](#).
5. Scan the appropriate two alphanumeric characters from the keypad in [Appendix D](#), that represent the desired character/value determined above. The second character will cause a two-beep indication.
6. Scan the ENTER/EXIT PROGRAMMING MODE bar code to exit Programming Mode.

This completes the procedure. See the table below for examples of how to set this feature.

Table 11 - Enable Character Setting Examples

STEP	ACTION	EXAMPLES			
1	Desired character/value	'e'	'}	'E'	Enable Command Not Used
2	Hex equivalent from ASCII Chart on page 288	0x65	0x7D	0x45	0xFF
3	Scan ENTER/EXIT PROGRAMMING MODE				
4	Scan SELECT ENABLE CHARACTER VALUE SETTING				
5	Scan two characters from Appendix D	'6' and '5'	'7' and 'D'	'4' and '5'	'F' and 'F'
6	Scan ENTER/EXIT PROGRAMMING MODE				

KEYBOARD INTERFACE

Wedge Quiet Interval

Specifies the amount of time the scanner looks for keyboard activity before it breaks the keyboard connection in order to transmit data to host. The range is from 0 to 990ms in 10ms increments.



NOTE: This feature applies ONLY to the Keyboard Wedge interface.

1. Determine the desired setting in milliseconds.
2. Divide the desired setting by 10 (setting is in 10ms increments). Pad the result with leading zeroes to yield two digits. For example: 0 = 00, 5 = 05, 20 = 20, etc.
3. Go to page 84 and scan the ENTER/EXIT PROGRAMMING MODE bar code to enter Prog. Mode.
4. Scan the bar code: SELECT WEDGE QUIET INTERVAL SETTING on [page 73](#).
5. Scan the appropriate two digits from the keypad in [Appendix D](#), that represent the duration which was determined in the steps above. You will hear a two-beep indication after the last character.



NOTE: If you make a mistake before the last character, scan the CANCEL bar code to abort and not save the entry string. You can then start again at the beginning.

6. Scan the ENTER/EXIT PROGRAMMING MODE bar code to exit.

This completes the procedure to set the Wedge Quiet Interval. See the table below for examples of how to set this feature.

Table 12 - Wedge Quiet Interval Setting Examples

STEP	ACTION	EXAMPLES			
1	Desired Setting	10ms	150ms	600ms	850ms
2	Divide by 10 (and pad with leading zeroes)	01	15	60	85
3	Scan ENTER/EXIT PROGRAMMING MODE				
4	Scan SELECT WEDGE QUIET INTERVAL SETTING				
5	Scan two characters from Appendix D	'0' and '1'	'1' and '5'	'6' and '0'	'8' and '5'
6	Scan ENTER/EXIT PROGRAMMING MODE				

Intercharacter Delay

This parameter specifies the intercharacter delay between the end of one character and the beginning of the next. The delay can be set within a range of zero (0) to 990 milliseconds in 10ms increments. A setting of zero specifies no delay.



NOTE: This feature applies ONLY to the Keyboard Wedge interface.

To set the delay:

1. Determine the desired setting in milliseconds.
2. Divide the desired setting by 10 (setting is in 10ms increments). Pad the result with leading zeroes to yield two digits. For example: 0 = 00, 5 = 05, 20 = 20, etc.
3. Go to page 85 and scan the ENTER/EXIT PROGRAMMING MODE bar code to enter Programming Mode.
4. Scan the bar code: SELECT INTERCHARACTER DELAY SETTING on [page 73](#).
5. Scan the appropriate two digits from the keypad in [Appendix D](#), that represent the duration which was determined in the steps above. You will hear a two-beep indication after the last character.



NOTE: If you make a mistake before the last character, scan the CANCEL bar code to abort and not save the entry string. You can then start again at the beginning.

6. Scan the ENTER/EXIT PROGRAMMING MODE bar code to exit Programming Mode. This completes the procedure. See the table below for examples of how to set this feature.

Table 13 - Intercharacter Delay Setting Examples

STEP	ACTION	EXAMPLES			
1	Desired Setting	50ms	150ms	600ms	850ms
2	Divide by 10 (and pad with leading zeroes to yield two-digits)	05	15	60	85
3	Scan ENTER/EXIT PROGRAMMING MODE				
4	Scan SELECT INTERCHARACTER DELAY SETTING				
5	Scan two characters from Appendix D	'0' and '5'	'1' and '5'	'6' and '0'	'8' and '5'
6	Scan ENTER/EXIT PROGRAMMING MODE				

Intercode Delay

Specifies the delay between labels transmitted to the host for this interface. The selectable range for this feature is from 0 to 99 seconds.

Follow these instructions to set this feature:

1. Determine the desired setting.
2. Pad the number with leading zeroes to yield two digits. For example: 0 = 00, 5 = 05, 20 = 20, etc
3. Go to page 86 and scan the ENTER/EXIT PROGRAMMING MODE bar code to enter Programming Mode.
4. Scan the bar code: SELECT INTERCODE DELAY SETTING on [page 74](#).
5. Scan the appropriate two digits from the keypad in [Appendix D](#), that represent the duration which was determined in the steps above. You will hear a two-beep indication after the last character.



NOTE: If you make a mistake before the last character, scan the CANCEL bar code to abort and not save the entry string. You can then start again at the beginning.

6. Scan the ENTER/EXIT PROGRAMMING MODE bar code to exit Programming Mode. This completes the procedure. See the table below for examples of how to set this feature.

Table 14 - Intercode Delay Setting Examples

STEP	ACTION	EXAMPLES			
1	Desired Setting	No Delay	5 seconds	60 seconds	99 seconds
2	Pad with leading zero(es)	00	05	60	99
3	Scan ENTER/EXIT PROGRAMMING MODE				
4	Scan SELECT INTERCODE DELAY SETTING				
5	Scan two characters from Appendix D	'0' and '0'	'0' and '5'	'6' and '0'	'9' and '9'
6	Scan ENTER/EXIT PROGRAMMING MODE				

DATA FORMAT

Data Editing

When a bar code is scanned, additional information can be sent to the host computer along with the bar code data. This combination of bar code data and supplementary user-defined data is called a “message string.” The Data Editing features can be used to build specific user-defined data into a message string.

There are several types of selectable data characters that can be sent before and after scanned data. You can specify if they should be sent with all symbologies, or only with specific symbologies. The following shows the available elements you can add to a message string:

Figure 22 - Breakdown of a Message String

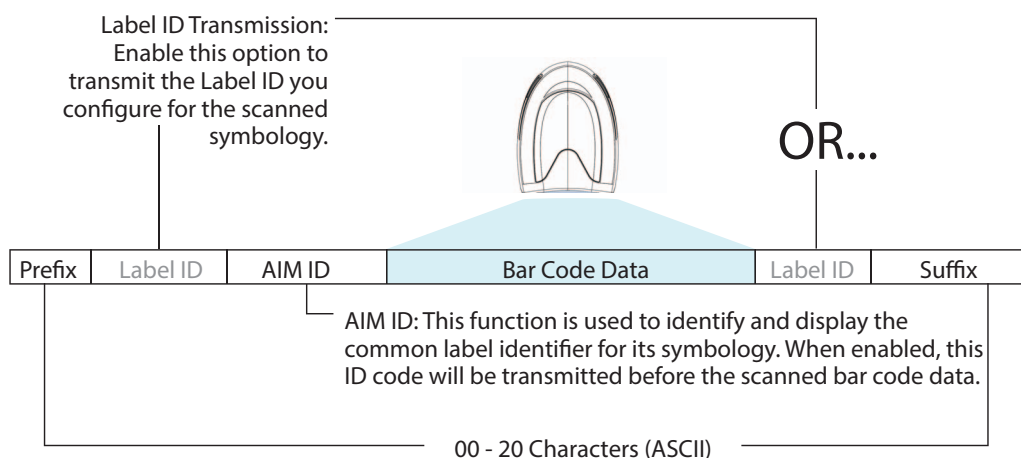

NOTE: Additional advanced editing is available. See the Advanced formatting features in the Datalogic Aladdin configuration software, or contact "Technical Support" on page xiii for more information.

Please Keep In Mind...

- Modifying a message string is not a mandatory requirement. Data editing is a sophisticated feature allowing highly customizable output for advanced users. Factory default settings for data editing is typically set to NONE.
- A prefix or suffix may be applied only to a specified symbology (reference [Symbologies, starting on page 111](#)) or across all symbologies (set via the Global features in [Configuration with Bar Codes, starting on page 31](#)).
- You can add any character from the ASCII Chart on [page 288](#) (from 00-FF) on the inside back cover of this manual as a prefix, suffix or Label ID.
- Enter prefixes and suffixes in the order in which you want them to appear on the output.

Global Prefix/Suffix

Up to 20 ASCII characters may be added as a prefix (in a position before the bar code data) and/or as a suffix (in a position following the bar code data) as indicated.

Figure 23 Prefix and Suffix Positions

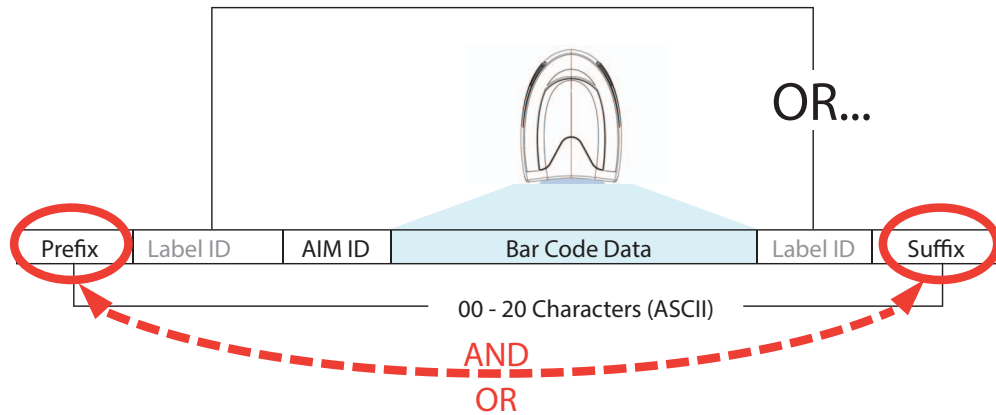

Example: Setting a Prefix

In this example, we'll set a prefix for all symbologies.

1. Determine which ASCII character(s) are to be added to scanned bar code data. In this example, we'll add a dollar sign ('\$') as a prefix.
2. Scan the ENTER/EXIT PROGRAMMING MODE bar code, then scan the SET GLOBAL PREFIX bar code.
3. Reference the ASCII Chart on [page 288](#) in [Appendix F](#) to find the hex value assigned to the desired character. The corresponding hex number for the '\$' character is 24. To enter this selection code, scan the '2' and '4' bar codes from [Appendix D](#).



NOTE: If you make a mistake before the last character, scan the CANCEL bar code to abort and not save the entry string. You can then start again at the beginning.

4. If less than the expected string of 20 characters are selected, scan the ENTER/EXIT bar code to terminate the string.
5. Scan the ENTER/EXIT bar code once again to exit Programming Mode.

The resulting message string would appear as follows:

Scanned bar code data: **12345**

Resulting message string output: **\$12345**

Global AIM ID



NOTE: This feature enables/disables addition of AIM IDs for all symbology types.

AIM label identifiers (as opposed to custom characters you select yourself as with label identifiers) can be included with scanned bar code data. AIM label identifiers consist of three characters as follows:

- A close brace character (ASCII '['), followed by...
- A code character (see the table below), followed by...
- A modifier character (the modifier character is symbol dependent).

SYMBOLGY	CHAR	SYMBOLGY	CHAR
UPC/EAN	E ^a	Code 128/GS1-128	C
Code 39 and Code 32	A	DataBar Omnidirectional, DataBar Expanded	e
Codabar	F	Standard 2 of 5	S
Interleaved 2 of 5	I	ISBN	X ^b
Code 93	G	Code 11	H

a. UPC-A and UPC-E labels are converted to EAN 13 when adding AIM IDs.

b. ISBN (X with a 0 modifier character)

Figure 24 AIM ID

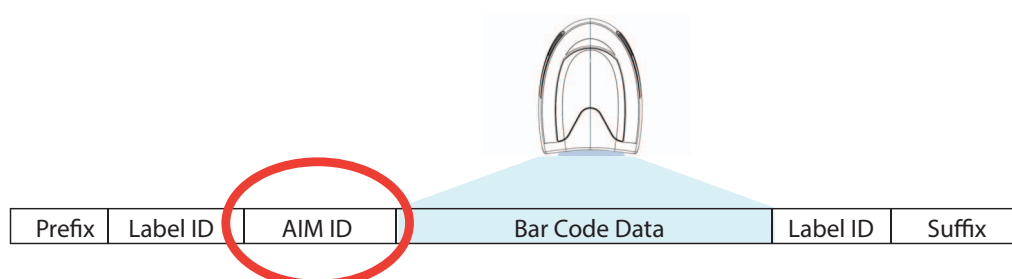

Label ID

A Label ID is a customizable code of up to three ASCII characters (each can be one of hex 0x01-0xFF), used to identify a bar code (symbology) type. It can be appended previous to or following the transmitted bar code data depending upon how this option is enabled. This feature provides options for configuring custom Label IDs as a pre-loaded set or individually per symbology (see "[Label ID: Set Individually Per Symbology](#)" on page 84). If you wish to program the scanner to always include an industry standard label identifier for ALL symbology types, see "[Global AIM ID](#)" on page 82.

Label ID: Pre-loaded Sets

The following table lists the pre-loaded label ID sets for the USA and Europe.

Table 15 - Label ID Pre-loaded Sets

SYMBOLGY	USA LABEL ID SET		EU LABEL ID SET	
	ASCII character	Hex value	ASCII character	Hexadecimal value
ABC Codabar	S	530000	S	530000
CODABAR	%	250000	R	520000
Code 39 CIP	Y	590000	Y	590000
Code 93	&	260000	U	550000
Code 11	CE	434500	b	620000
Code 128	#	230000	T	540000
Code 32	A	410000	X	580000
Code 39	*	2A0000	V	560000
Datalogic 2of5	s	730000	s	730000
EAN13	F	460000	B	420000
EAN13 P2	F	460000	L	4C0000
EAN13 P5	F	460000	M	4D0000
EAN8	FF	464600	A	410000
EAN8 P2	FF	464600	J	4A0000
EAN8 P5	FF	464600	K	4B0000
FOLLETT 2OF5	O	4F0000	O	4F0000
GS1 DATABAR EXPANDED	RX	525800	t	740000
GS1 DATABAR LIMITED	RL	524C00	v	760000
GS1 DATABAR OMNIDIRECTIONAL	R4	523400	u	750000
GS1-128		000000	k	6B0000
I2OF5	i	690000	N	4E0000
IATA	IA	494100	&	260000
Industrial 2 of 5	W	570000	W	570000
Interleaved 2 of 5	e	650000	e	650000
ISBN	l	490000	@	400000
ISBT128	f	660000	f	660000

SYMBOLGY	USA LABEL ID SET		EU LABEL ID SET	
ISSN	n	6E0000	n	6E0000
MSI	@	400000	Z	5A0000
S25	s	730000	P	500000
UPCA	A	410000	C	430000
UPCA P2	A	410000	F	460000
UPCA P5	A	410000	G	470000
UPCE	E	450000	D	440000
UPCE P2	E	450000	H	480000
UPCE P5	E	450000	I	490000
OCR-A	o	6F0000	\$o	246F00
OCR-B	o	6F0000	\$p	247000
MICR	o	6F0000	\$m	246D00

Label ID: Set Individually Per Symbology

To configure a Label ID individually for a single symbology:

1. Scan the ENTER/EXIT bar code.
2. Select Label ID position as either BEFORE (Enable as Prefix) or AFTER (Enable as Suffix) by scanning the appropriate bar code in the section "Label ID Control" on page 84. Reference Figure 25 for Label ID positioning options if multiple identification features are enabled.
3. Scan a bar code to select the symbology for which you wish to configure a custom Label ID from the section "Label ID Symbology Selection" on page 85.
4. Determine the desired character(s) (you may choose up to three) which will represent the Label ID for the selected symbology.
5. Turn to the ASCII Chart on page 288 on the inside back cover of this manual and find the equivalent hex digits associated with your choice of Label ID. For example, if you wish to select an equal sign (=) as a Label ID, the chart indicates its associated hex characters as 3D. Turn to Keypad, in Appendix D, and scan the bar codes representing the hex characters determined. For the example given, the characters '3' and 'D' would be scanned. More examples of Label ID settings are provided in Table 16 on page 237.



NOTE: If you make a mistake before the last character, scan the CANCEL bar code to abort and not save the entry string. You can then start again at the beginning.

6. Scan the ENTER/EXIT bar code to exit Label ID entry.
7. Scan the ENTER/EXIT bar code once again to exit Programming Mode.

This completes the steps to configure a Label ID for a given symbology.

Figure 25 Label ID Position Options

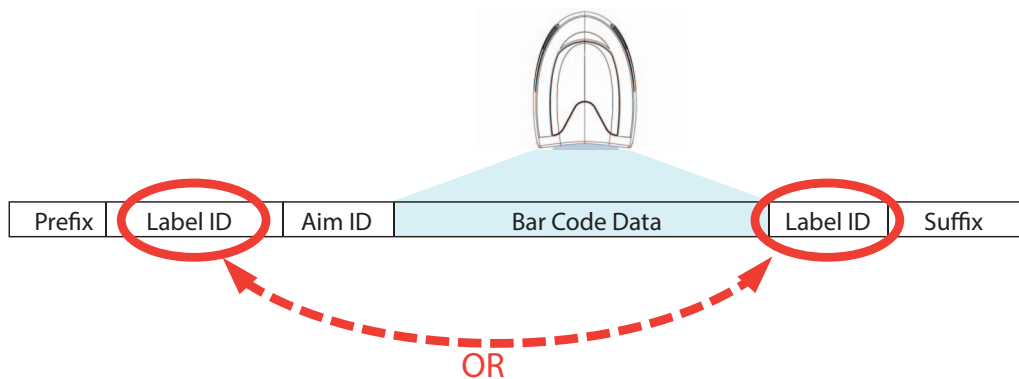

Label ID: Set Individually Per Symbology — continued

Table 16 Label ID Examples

STEP	ACTION	EXAMPLES			
1	Scan the ENTER/EXIT bar code	(Scanner enters Programming Mode)			
2	Determine placement of the Label ID characters BEFORE or AFTER with regard to scanned data using Label ID Control, starting on page 84	Enable as Prefix	Enable as Suffix	Enable as Prefix	Enable as Suffix
3	Scan the bar code selecting the symbology type you wish to designate label ID characters for using Label ID Symbology Selection, starting on page 85	GS1 DataBar Omnidirectional	Code 39	Interleaved 2 of 5	Code 32
4	Custom Label ID example (desired characters):	D B *	= C 3	+	PH
5	Find hex equivalents from the ASCII table (inside back cover), then scan in these digits/characters using the bar codes in the section: Keypad, starting on page 275. If you make a mistake before the last character, scan the CANCEL bar code to abort and not save the entry string. You can then start again at the beginning.	44 42 2A	3D 43 33	2B	50 48
6	Scan the ENTER/EXIT bar code	(Scanner exits Label ID entry)			
7	Scan the ENTER/EXIT bar code once again	(Scanner exits Programming Mode)			
Result:		DB*[bar code data]	[bar code data]=C3	+ [bar code data]	[bar code data]PH

Character Conversion

Character conversion is an eight byte configuration item. The eight bytes are 4 character pairs represented in hexadecimal ASCII values. The first character in the pair is the character that will be converted. The second character in the pair is the character to convert to. If the character to convert in a pair is FF, then no conversion is done.

For example, if you have the character conversion configuration item set to the following: 41423132FFFFFFFF

The first pair is 4142 or AB (41 hex is an ASCII capital A, 42 hex is an ASCII capital B) and the second pair is 3132 or 12 (31 hex is an ASCII 1, 32 is an ASCII 2). The other two pairs are FFFF and FFFF.

With the label, AB12BA21, it would look as follows after the character conversion: BB22BB22.

The A characters were converted to B characters and the 1 characters were converted to 2 characters. Nothing is done with the last two character pairs, since they are all FF.

To set Character Conversion:

1. Scan the ENTER/EXIT bar code.
2. Scan the bar code for "[Character Conversion](#)" on page 90
3. Determine the desired string. Sixteen positions must be determined as in the above example. Next, turn to the ASCII Chart on [page 288](#) on the inside back cover of this manual and find the equivalent hex digits needed to fulfill the string.
4. Turn to [Appendix D](#), Keypad and scan the bar codes representing the hex characters determined in the previous step.
5. Scan the ENTER/EXIT bar code to exit Programming Mode.



NOTE: If less than the expected string of 16 characters are selected, scan the ENTER/EXIT bar code twice to accept the selections and exit Programming Mode.

SCANNING FEATURES

Scan Mode

Selects the scan operating mode for the reader. Selections are:

Trigger Single: When the trigger is pulled, scanning is activated until one of the following occurs:

- Stand Mode/Object Detection has elapsed
- a label has been read
- the trigger is released

This mode is associated with typical handheld reader operation: when the trigger is pulled, scanning starts and the product scans until the trigger is released, or a label is read, or the maximum Stand Mode/Object Detection has elapsed.

Trigger Hold Multiple : When the trigger is pulled, scanning starts and the product scans until the trigger is released or Stand Mode/Object Detection has elapsed. Reading a label does not disable scanning. Double Read Timeout prevents undesired multiple reads of the same label while in this mode.

Trigger Pulse Multiple: When the trigger is pulled, continuous scanning is activated until Stand Mode/Object Detection has elapsed or the trigger has been released and pulled again. Double Read Timeout prevents undesired multiple reads of the same label while in this mode.

Flashing: The reader flashes¹ on and off regardless of the trigger status. Flash rate is controlled by Flash On Time and Flash Off Time. When Flash is ON the reader reads continuously. When Flash is OFF scanning is deactivated.

Always On: No trigger pull is required to read a bar code. Scanning is continually on. Double Read Timeout prevents undesired multiple reads of the same label while in this mode.

Stand Mode/Object Detection: No trigger pull is required to read a bar code. Scanning turns on automatically when an item is placed in reader's field of view. While in a stand watch state, the reader illumination LED goes from dim to maximum bright.

1. Controlled by Flash On Time.

Scanning Active Time

This setting specifies the amount of time that the reader stays in scan ON state once the state is entered. The range for this setting is from 1 to 255 seconds in 1-second increments.

Follow these instructions to set this feature:

1. Determine the desired setting.
2. Pad the result with leading zeroes to yield three digits. For example: 0 = 000, 5 = 005, 20 = 020, etc.
3. Scan the ENTER/EXIT PROGRAMMING MODE bar code to enter Programming Mode.
4. Scan the bar code: SELECT SCANNING ACTIVE TIME SETTING on [page 93](#).
5. Scan the appropriate two digits from the keypad in [Appendix D](#), that represent the duration which was determined in the steps above. You will hear a two-beep indication after the last character.



NOTE: If you make a mistake before the last character, scan the CANCEL bar code to abort and not save the entry string. You can then start again at the beginning.

6. Scan the ENTER/EXIT PROGRAMMING MODE bar code to exit Programming Mode. This completes the procedure. See the table below for examples of how to set this feature.

Table 17 Scanning Active Time Setting Examples

STEP	ACTION	EXAMPLES			
1	Desired Setting	1 Second	90 Sec. (1.5 min.)	180 Sec. (3 min.)	255 Seconds (4.25 min.)
2	Pad leading zero(es)	001	090	180	255
3	Scan ENTER/EXIT PROGRAMMING MODE				
4	Scan SELECT SCANNING ACTIVE TIME SETTING				
5	Scan three characters from Appendix D	'0', '0' and '1'	'0', '9' and '0'	'1', '8' and '0'	'2', '5' and '5'
6	Scan ENTER/EXIT PROGRAMMING MODE				

Aiming Duration Time

Specifies the frame of time the aiming pointer remains on after decoding a label, when in trigger single mode. The range for this setting is from 1 to 255 seconds in 1-second increments.

Follow these instructions to set this feature:

1. Determine the desired setting.
2. Pad the result with leading zeroes to yield three digits. For example: 0 = 000, 5 = 005, 20 = 020, etc.
3. Scan the ENTER/EXIT PROGRAMMING MODE bar code to enter Programming Mode.
4. Scan the bar code: SELECT AIMING DURATION TIME SETTING.
5. Scan the appropriate two digits from the keypad in [Appendix D](#), that represent the duration which was determined in the steps above. You will hear a two-beep indication after the last character.



NOTE: If you make a mistake before the last character, scan the CANCEL bar code to abort and not save the entry string. You can then start again at the beginning.

6. Scan the ENTER/EXIT PROGRAMMING MODE bar code to exit Programming Mode. This completes the procedure. See Table 25 for some examples of how to set this feature.

Table 18 Aiming Duration Time Setting Examples

STEP	ACTION	EXAMPLES			
1	Desired Setting	1 Second	90 Sec. (1.5 min.)	180 Sec. (3 min.)	255 Seconds (4.25 min.)
2	Pad leading zero(es)	001	090	180	255
3	Scan ENTER/EXIT PROGRAMMING MODE				
4	Scan SELECT AIMING DURATION TIME SETTING				
5	Scan three characters from Appendix D	'0', '0' and '1'	'0', '9' and '0'	'1', '8' and '0'	'2', '5' and '5'
6	Scan ENTER/EXIT PROGRAMMING MODE				

Flash On Time

This feature specifies the ON time for the indicator LED while in Flash Mode. The selectable range is 100 to 9,900 milliseconds (0.1 to 9.9 seconds), in 100 millisecond increments.

Follow these instructions to set this feature.

1. Determine the desired setting in milliseconds.
2. Divide the desired setting by 100 (setting is in 100ms increments). Pad the result with leading zeroes to yield two digits. For example: 0 = 00, 5 = 05, 20 = 20, etc.
3. Scan the ENTER/EXIT PROGRAMMING MODE bar code to enter Programming Mode.
4. Scan the bar code: SELECT FLASH ON TIME SETTING on [page 93](#).
5. Scan the appropriate two digits from the keypad in [Appendix D](#), that represent the duration which was determined in the steps above. You will hear a two-beep indication after the last character.



NOTE: If you make a mistake before the last character, scan the CANCEL bar code to abort and not save the entry string. You can then start again at the beginning.

6. Scan the ENTER/EXIT PROGRAMMING MODE bar code to exit Programming Mode. This completes the procedure. See the table below for examples of how to set this feature.

Table 19 Flash On Time Setting Examples

STEP	ACTION	EXAMPLES			
1	Desired Setting	500ms	1,000ms (1 sec.)	5200ms (5.2 sec.)	9,900ms (9.9 sec.)
2	Divide by 100 (and pad with leading zeroes to yield two digits)	05	10	52	99
3	Scan ENTER/EXIT PROGRAMMING MODE				
4	Scan SELECT FLASH ON TIME SETTING				
5	Scan two characters from Appendix D	'0' and '5'	'1' and '0'	'5' and '2'	'9' and '9'
6	Scan ENTER/EXIT PROGRAMMING MODE				

Flash Off Time

This feature specifies the OFF time for the indicator LED while in Flash Mode. The selectable range is 100 to 9,900 milliseconds (0.1 to 9.9 seconds), in 100 millisecond increments.

Follow these instructions to set this feature.

1. Determine the desired setting in milliseconds.
2. Divide the desired setting by 100 (setting is in 100ms increments). Pad the result with leading zeroes to yield two digits. For example: 0 = 00, 5 = 05, 20 = 20, etc.
3. Scan the ENTER/EXIT PROGRAMMING MODE bar code to enter Programming Mode.
4. Scan the bar code: SELECT FLASH OFF TIME SETTING on [page 94](#).
5. Scan the appropriate two digits from the keypad in [Appendix D](#), that represent the duration which was determined in the steps above. You will hear a two-beep indication after the last character.



NOTE: If you make a mistake before the last character, scan the CANCEL bar code to abort and not save the entry string. You can then start again at the beginning.

6. Scan the ENTER/EXIT PROGRAMMING MODE bar code to exit Programming Mode.

This completes the procedure. See the table below for examples of how to set this feature.

Table 20 Flash Off Time Setting Examples

STEP	ACTION	EXAMPLES			
1	Desired Setting	500ms	1,000ms (1 sec.)	5200ms (5.2 sec.)	9,900ms (9.9 sec.)
2	Divide by 100 (and pad with leading zeroes to yield two digits)	05	10	52	99
3	Scan ENTER/EXIT PROGRAMMING MODE				
4	Scan SELECT FLASH OFF TIME SETTING				
5	Scan two characters from Appendix D	'0' and '5'	'1' and '0'	'5' and '2'	'9' and '9'
6	Scan ENTER/EXIT PROGRAMMING MODE				

LED AND BEEPER INDICATORS

Good Read LED Duration

This feature specifies the amount of time that the Good Read LED remains on following a good read. The good read LED on time can be set within a range of 10 milliseconds to 2,550 milliseconds (0.001 to 2.55 seconds) in 100ms increments.

Follow these instructions to set this feature:

1. Determine the desired setting in milliseconds. A setting of 0 means that the good read LED stays on until the next time the trigger is pulled.
2. Divide the desired setting by 10 (setting is in 100ms increments). Pad the result with leading zeroes to yield three digits. For example: 0 = 000, 5 = 000, 20 = 020, etc.
3. Go to page 100 and scan the ENTER/EXIT PROGRAMMING MODE bar code to enter Programming Mode.
4. Scan the bar code: SELECT GOOD READ LED DURATION SETTING.
5. Scan the appropriate two digits from the keypad in [Appendix D](#), that represent the duration which was determined in the steps above. You will hear a two-beep indication after the last character.



NOTE: If you make a mistake before the last character, scan the CANCEL bar code to abort and not save the entry string. You can then start again at the beginning.

6. Scan the ENTER/EXIT PROGRAMMING MODE bar code to exit Programming Mode. This completes the procedure. See the following table for some examples of how to set this feature.

Table 21 Good Read LED Duration Setting Example

STEP	ACTION	EXAMPLES			
1	Desired Setting	Good Read LED stays on until next trigger pull (00)	20ms	150ms	2550ms (2.55 sec.)
2	Divide by 10 (and pad with leading zeroes)	000	002	015	255
3	Scan ENTER/EXIT PROGRAMMING MODE				
4	Scan SELECT GOOD READ LED DURATION SETTING				
5	Scan three characters from Appendix D	'0', '0' and '0'	'0', '0' and '2'	'0', '1' and '5'	'2', '5' and '5'
6	Scan ENTER/EXIT PROGRAMMING MODE				

RF FEATURES

Automatic Configuration Update

When this feature is enabled, the base station and reader will keep their configurations synchronized. If a reader's configuration is altered by reading programming labels, this change is automatically transferred and updated in a linked base station. Likewise, if the base station's configuration is changed using Aladdin or by host commands, then the reader's configuration will automatically be updated if this feature is enabled.

RF Address Stamping

Source Radio Address Delimiter Character

This option specifies the delimiter character to be placed between the label data and radio address when address stamping is enabled.

Follow these instructions to select the delimiter character:

1. Determine the desired character, then find its hexadecimal equivalent on the ASCII Chart on [page 288](#). A setting of 00 specifies no delimiter character.
2. Scan the ENTER/EXIT PROGRAMMING MODE bar code to enter Programming Mode.
3. Scan the bar code: SET SOURCE RADIO ADDRESS DELIMITER CHARACTER.
4. Scan the appropriate two digits from the keypad in [Appendix D](#), that represent the hexadecimal characters which were determined in the steps above. You will hear a two-beep indication after the last character.



NOTE: If you make a mistake before the last character, scan the CANCEL bar code to abort and not save the entry string. You can then start again at the beginning.

5. Scan the ENTER/EXIT PROGRAMMING MODE bar code to exit.

Table 22 Source Radio Address Delimiter Character Setting Examples

STAR Radio Protocol Timeout

This parameter sets the valid wait time before transmission between the handheld reader and Base Station is considered failed.

When setting this parameter, take into consideration the radio traffic (number of readers in the same area). The selectable range for this feature is from 02 to 25 seconds.

Follow these instructions to set this feature:

1. Determine the desired setting.
2. Pad the number with leading zeroes to yield two digits. For example: 2 = 02, 5 = 05, 25 = 25, etc
3. Scan the ENTER/EXIT PROGRAMMING MODE barcode to enter Programming Mode.
4. Scan the barcode: SELECT RADIO PROTOCOL TIMEOUT.
5. Scan the appropriate two digits from the keypad in [Appendix D](#), that represent the duration which was determined in the steps above. You will hear a two-beep indication after the last character.



NOTE: If you make a mistake before the last character, scan the CANCEL bar code to abort and not save the entry string. You can then start again at the beginning.

6. Scan the ENTER/EXIT PROGRAMMING MODE barcode to exit Programming Mode. This completes the procedure. See Table 29 for some examples of how to set this feature.

Table 23 STAR Radio Protocol Timeout Examples

STEP	ACTION	EXAMPLES			
1	Desired Setting	No delimiter character	, (comma)	- (dash)	/ (slash)
2	Scan ENTER/EXIT PROGRAMMING MODE				
3	Scan SET SOURCE RADIO ADDRESS DELIMITER CHARACTER				
4	Scan two characters from Appendix D	'0' and '0'	'2' and 'C'	'2' and 'D'	'2' AND 'F'
5	Scan ENTER/EXIT PROGRAMMING MODE				

SYMBOLOGIES

Set Length

Length Control allows you to select either variable length decoding or fixed length decoding for the specified symbology.

Variable Length: For variable length decoding, a minimum and maximum length may be set.

Fixed Length: For fixed length decoding, two different lengths may be set.

Set Length 1

This feature specifies one of the bar code lengths for a given symbology. Length 1 is the minimum label length if in Variable Length Mode, or the first fixed length if in Fixed Length Mode.

Reference the Symbologies section on [page 111](#) to view the selectable range (number of characters) for the symbology being set.

Follow these instructions to set this feature:

1. Determine the desired character length. Pad the number with leading zeroes to yield two digits. For example: 0 = 00, 5 = 05, 20 = 20, etc.
2. Scan the ENTER/EXIT PROGRAMMING MODE bar code to enter Programming Mode.
3. Scan the "Select Length 1 Setting" for the symbology being set.
4. Scan the appropriate two digits from the keypad in [Appendix D](#), that represent the length setting which was determined in the steps above. You will hear a two-beep indication after the last character.



NOTE: If you make a mistake before the last character, scan the CANCEL bar code to abort and not save the entry string. You can then start again at the beginning.

5. Scan the ENTER/EXIT PROGRAMMING MODE bar code to exit Programming Mode. This completes the procedure. See the table below for examples of how to set this feature.

Table 24 Length 1 Setting Examples

STEP	ACTION	EXAMPLES			
1	Desired Setting	01 Character	07 Character	52 Character	74 Character
2	Scan ENTER/EXIT PROGRAMMING MODE				
3	Scan SELECT LENGTH 1 SETTING for the desired symbology				
4	Scan two characters from Appendix D	'0' and '1'	'0' and '7'	'5' and '2'	'7' AND '4'
5	Scan ENTER/EXIT PROGRAMMING MODE				

Set Length 2

This feature specifies one of the bar code lengths for a given symbology. Length 2 is the maximum label length if in Variable Length Mode, or the second fixed length if in Fixed Length Mode.

Reference the Symbologies section on [page 111](#) to view the selectable range (number of characters) for the symbology being set. A setting of 00 specifies to ignore this length (only one fixed length).

Follow these instructions to set this feature:

1. Determine the desired character length. Pad the number with leading zeroes to yield two digits. For example: 0 = 00, 5 = 05, 20 = 20, etc.
2. Scan the ENTER/EXIT PROGRAMMING MODE bar code to enter Programming Mode.
3. Scan the “Select Length 2 Setting” for the symbology being set.
4. Scan the appropriate two digits from the keypad in [Appendix D](#), that represent the length setting which was determined in the steps above. You will hear a two-beep indication after the last character.



NOTE: If you make a mistake before the last character, scan the CANCEL bar code to abort and not save the entry string. You can then start again at the beginning.

5. Scan the ENTER/EXIT PROGRAMMING MODE bar code to exit Programming Mode.

This completes the procedure. See the table below for examples of how to set this feature.

Table 25 Length 2 Setting Examples

STEP	ACTION	EXAMPLES			
1	Desired Setting	00 (ignore second length)	07 Character	52 Character	74 Character
2	Scan ENTER/EXIT PROGRAMMING MODE				
3	Scan SELECT LENGTH 2 SETTING				
4	Scan two characters from Appendix D	'0' and '0'	'0' and '7'	'5' and '2'	'7' AND '4'
5	Scan ENTER/EXIT PROGRAMMING MODE				

CHAPTER 5

MESSAGE FORMATTING

MESSAGE FORMATTING



NOTE: Message Formatting is only available for the Gryphon™ Wireless model.

A message from the Host to the base must follow these rules:

- If Address stamping options or address delimiter are enabled on the base, the Host replay must have address field and delimiter too. Otherwise the message will be ignored. Address delimiter is present only when address stamping is enabled.
- Address stamping is necessary to correctly route the message to the Gryphon I, especially when more than one handheld is linked to the same base. Address stamping could be disabled if the system is in point to point configuration. If address stamping is not enabled, the messages are addressed to the first handheld linked to the base.
- The maximum character length for messages is 48.
- Messages end with “CR” 0x0D ASCII character. The CR character cannot be contained in the middle.
- Messages cannot start with '\$' or # because these are reserved for Service mode command
- Base station can receive host message only if Host Commands Obey/Ignore is set to Ignore.
- Message could be sent to the HH in response to a Label when “Transmit mode” require Ack from Host (see transmit mode parameter) or at any time. When messages are sent not in response to a label must start with DC2 0x12 ASCII character and could be sent in any transmit mode setting.
- Message could be sent to all HH linked to base by using a Multicast message: “00 00 00 00 2A AA”
- In order to receive a message, handhelds must not be in sleep state.
- If you want to control the Scanner's beeper from the host, you will also probably want to disable the good transmission beep that is emitted when the code is received from the cradle. (See "[Wireless Features](#)" on page 195).
- The message field can store plain text and escape sequences. Escape sequences are interpreted as commands.

The format of the ACK from Host message (used for transmission mode 02) is:

[Scanner_Addr] [Scanner_Addr_delimiter] MESSAGE <CR>

The format of a generic message From Host to HH is:

[Scanner_Addr] [Scanner_Addr_delimiter] DC2 MESSAGE <CR>

where DC2 is ASCII 0x12 (^R) character.

[Items in square brackets are optional.]

LED AND BEEPER CONTROL

The LED control escape sequences are intended to activate the LEDs for short periods of time and can be used in combination with the Beeper. The LED and Beeper will be controlled by the system after the entire command sequence is interpreted.

ESC SEQUENCE	ACTION
Esc [0 q	Emit short High tone + short delay
Esc [1 q	Emit short Low tone + short delay
Esc [2 q	Emit long Low tone + short delay
Esc [3 q	Emit good read tone
Esc [4 q	Emit bad tx tone
Esc [5 q	Wait 100 ms
Esc [6 q	Turn on the green LED
Esc [7 q	Turn off the green LED
Esc [8 q	Turn on the green spot
Esc [9 q	Turn off the green spot
Esc [0 r	Beep for Find me function
Esc [1 r	Power-off

Example:

Esc [6 q Esc [3 q Esc [7 q	Turns on the green LED, emits a good read tone, and turns off the green LED.
Esc [6 q Esc [5 q Esc [7 q	Turns on the green LED for 100 ms and then turns off the green LED.

Escape sequences different from those listed will be ignored.

APPENDIX A

TECHNICAL SPECIFICATIONS

The table below contains Physical and Performance Characteristics, User Environment and Regulatory information. Table 34 provides Standard Cable Pinouts.

GD4200 TECHNICAL SPECIFICATIONS

Table 26 GD4200 Technical Specifications

ELECTRICAL CHARACTERISTICS	
Power Supply	GD4220: 5VDC \pm 5% GD4290: 4.5 - 14.0 VDC
Consumption	Operating (Typical): <350mA @ 5V <150mA @12V Standby/Idle (Typical): <60mA @5V <30mA @12V
Max. Scan Rate	400 reads/sec
Reading Indicators	Top and rear illumination, Good Read Spot, Beep
OPTICAL CHARACTERISTICS	
Optical Format	CCD solid state sensor (2500 pixels)
Illumination System	LED Source Dual LED Array 612-630nm
Ambient Light Up to	130,000 lux
Tilt Tolerance ^a	+/- 45°
Pitch Tolerance ^a	+/- 65°
Skew Tolerance ^a	+/- 65°
Field of View ^a	HORIZONTAL 36° +/- 1°
PCS (Datalogic Test Chart)	minimum 15%

ENVIRONMENTAL CHARACTERISTICS	
Operating Temperature	0 °C to + 50 °C (+32° F to +122 °F)
Storage Temperature	-40 °C to + 70 °C (-40 ° F to +158 °F)
Humidity	95% non condensing
Drop Resistance	IEC 68-2-32 Tested 1.8 m (6 ft)
ESD Protection	16 KV
Protection Class	IP52
Cable Length	Refer to www.datalogic.com
PHYSICAL CHARACTERISTICS	
Color	Black White
Dimensions	Height 16.6 cm (6.5") Length 10.9 cm (4.3") Width 6.8 cm (2.7")
Weight (without cable)	GD4200 approx. 163 g (5.75 oz.)

a. Based on ISO 15423 specifications

GBT/GM4200 TECHNICAL SPECIFICATIONS

Table 27 GBT/GM4200 Technical Specifications

ELECTRICAL CHARACTERISTICS	
Power Supply (WLC4190)	4.5VDC - 14VDC ± 5%
Consumption (Typical)	Gun Only: 750mA Cradle Only: 70mA Cradle with Gun in Charge 380mA (PC host USB) 1030mA @ 5V host Type-C 400mA @ 12V on USB external powered cable
Max. Scan Rate	400 reads/sec
Reading Indicators	Top and rear illumination, Good Read Spot, Beep
Battery Capacity	Li-Ion 3.6V, 2550 mAh (9.2W/h)
Recharge Time (Typical)	Values valid for a fully depleted battery USB Only: 10h Type C: 4.5h USB external power: 4h

OPTICAL CHARACTERISTICS	
Optical Format	CCD solid state sensor (2500 pixels)
Illumination System	LED Source Dual LED Array 612-630nm
Ambient Light	Up to 130,000 lux
Tilt Tolerance ^a	+/- 45°
Pitch Tolerance ^a	± 65°
Skew Tolerance ^a	± 65°
Field of View ^a	HORIZONTAL 36° +/- 1°
PCS (Datalogic Test Chart)	minimum 15%
ENVIRONMENTAL CHARACTERISTICS	
Operating Temperature	0 °C to + 50 °C (+32° F to +122 °F)
Storage Temperature	-40 °C to + 70 °C (-40 ° F to +158 °F)
Humidity	95% non condensing
Drop Resistance	IEC 68-2-32 Tested 1.8 m (6 ft)
ESD Protection	16 KV
Protection Class	IP52
Cable Length	Refer to www.datalogic.com
PHYSICAL CHARACTERISTICS	
Color	Black White
Dimensions	Gun only (L/H/P): 68.4 x 165.8 x 110.0mm (2.7" x 6.5" x 4.3") Cradle only (L/H/P): 203.3 x 84 x 94mm (8,0" x 3,3" x 3,7") Gun on Cradle (L/H/P): 203,3 x 84 x 107,3mm (8,0" x 3,3" x 4,2")
Weight	GBT/GM4200: approx. 175g (6.2 oz.) without battery / approx. 230g (8.11 oz.) with battery WLC4190: approx. 232g (8.2 oz.)

a. Based on ISO 15423 specifications.

RADIO CHARACTERISTICS			
Wireless Technology	Star™ 910 MHz	Star™ 433 MHz	Bluetooth
Range (in open air)	50 m	50 m	100 m
Max number of devices per base station	16		7

COMMON READING CHARACTERISTICS

Table 28 Reading Characteristics

READING CHARACTERISTICS	
DOF ^a	Code 39 5mils: 50 to 370mm / 1.97 to 14.6 inch ^b
	Code 39 7.5mils: 50 to 540mm / 1.97 to 21.3 inch ^b
	Code 39 10mils: 50 to 735mm / 1.97 to 28.9inch ^b
	Code 39 20mils: 25 to 1470mm / 0.98 to 57.87 inch ^b
	EAN13 13 mils: 35 to 900mm / 1.38 to 35.43 inch ^b
Resolution (Maximum)	0.0077mm /3mils

- a. The depth of field is defined by an arc and not a plane. Shorter bar codes of a given resolution can be read at a further distance than longer bar codes (as explained in the following image).
- b. All labels grade A, typical environmental light, 20°C, label inclination 10°.

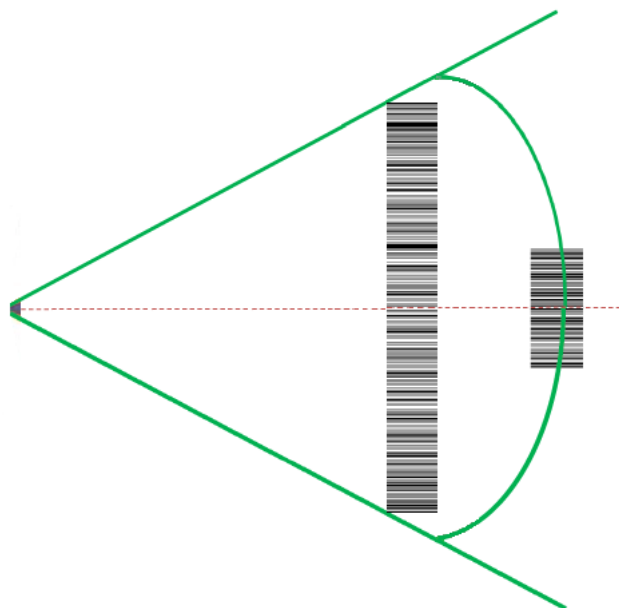

DECODING CAPABILITIES

DECODE CAPABILITY

1D Bar Codes

UPC/EAN/JAN (A, E, 13, 8); UPC/EAN/JAN (including P2 /P5); UPC/EAN/JAN (including; ISBN / Bookland & ISSN); UPC/EAN Coupons;

Code 39 (including full ASCII); Code 39 Trioptic; Code39 CIP (French Pharmaceutical); LOG-MARS (Code 39 w/ standard check digit enabled); Danish PPT; Code 32 (Italian Pharmacode 39);

Code 128; Code 128 ISBT;

Interleaved 2 of 5; Standard 2 of 5; Interleaved 2 of 5 CIP (HR); Industrial 2 of 5; Discrete 2 of 5; Datalogic 2 of 5 (China Post Code/Chinese 2 of 5); IATA 2 of 5 Air cargo code; Follet 2 of 5;

Codabar; Codabar (NW7); ABC Codabar;

Code 11; Code 93; MSI; PZN; Plessey; Anker Plessey;

GS1 DataBar Limited; GS1 DataBar Expanded; GS1 DataBar Truncated; DATABAR Expanded Coupon.

LED AND BEEPER INDICATIONS

The imager's beeper sounds and its illumination flashes or changes color to indicate various functions or errors on the reader. A "Green Spot" also lights to indicate a good read. The tables below list these indications.

Table 29 LED and Beeper Indications

INDICATION	LED	BEEPER
Power-up	Upper LED flashes/blinks on power-up, however, this may be too rapid to view. With a USB interface, the LED blinks until enumeration with the host is completed.	Reader beeps four times at highest frequency and volume upon power-up.
Good Read	Upper green LED comes on for programmed time (default). LED behavior for this indication is configurable using Aladdin utility.	One beep at current frequency, volume, mono/bi-tonal setting upon a successful label scan. It is also possible to upload custom jingles with Aladdin.
ROM Failure	200 ms on ↔ 200 ms off	Reader sounds one error beep at highest volume for 200 ms.
Limited Scanning Label Read	N/A	Reader 'chirps' six times at the highest frequency and current volume.
Reader Disabled	The LED blinks continuously 100 ms on ↔ 900 ms off	N/A

USER INDICATIONS FOR GD4200

Table 30 User Indications for GD4200

STATUS	3GL AND GOOD READ LED
Power-up	OFF
USB Enumeration Phase	250 ms ON ↔ 250 ms OFF
USB Suspend	Depends on Power Cable and specific configurations
Idle	OFF
While Reading	OFF
Decode Done	Solid ON Programmable Duration (1 s default)
Reader Disabled (POS) Communication with host not established	100 ms ON ↔ 900 ms OFF
Firmware Upgrade	250 ms ON ↔ 250 ms OFF
Host Download	250 ms ON ↔ 250 ms OFF
Enter Service Mode	No Effect
Label Programming	No Effect

USER INDICATIONS FOR GBT/GM4200 (GUN ONLY)

Table 31 User Indications for GBT/GM4200 Gun

STATUS	3GL AND GOOD READ LED	BATTERY LED
Power-up	OFF	OFF
USB Enumeration Phase	250 ms ON ↔ 250 ms OFF	OFF
USB Suspend	Depends on Power Cable and specific configurations	OFF
Idle	OFF	OFF
While Reading	OFF	OFF
Decode Done	Solid ON Programmable Duration (1 s default)	OFF
Reader Disabled (POS) Communication with host not established	100 ms ON ↔ 900 ms OFF	OFF
Firmware Upgrade	250 ms ON ↔ 250 ms OFF	OFF

STATUS	3GL AND GOOD READ LED	BATTERY LED
Host Download	250 ms ON ↔ 250 ms OFF	OFF
Paging Answer	5 cycles: 100 ms ON ↔ 900 ms OFF	OFF
Enter Service Mode	No Effect	OFF
Label Programming	No Effect	OFF
ACK Received on Transmission	OFF	OFF
ACK NOT Received on Transmission	OFF	OFF
Cradle in USB Suspend	Depends on Power Cable and specific configurations	OFF
Configuration Alignment	250 ms ON ↔ 250 ms OFF	OFF
Charge Fault	OFF	OFF
Charge in Progress through Cradle	OFF	OFF
Charge Complete through Cradle	OFF	OFF
Battery Status indications when not charging, using double tap	OFF	Solid with programmable duration (3 s default) and then OFF Green (charge = 50% - 100%) Amber (charge = 2% - 50%) Red forced loop (charge less than 2%)

USER INDICATIONS FOR WLC4190 BASE STATIONS

Table 32 User Indications for WLC4190 Base Stations

STATUS	TRANSMISSION LEDES	CHARGING LEDES
Power-up	Solid ON	OFF
USB Enumeration	250 ms ON ↔ 250 ms OFF	OFF
USB Suspend	Depends on Power Cable and specific configurations	OFF
Idle	Solid ON	OFF
While Reading	Solid ON	OFF
Label Transmitted to Host	OFF for 100 ms andd then Solid ON	OFF
Reader Disabled (POS) Communication with host not established	100 ms ON ↔ 900 ms OFF	OFF
Firmware Upgrade	250 ms ON ↔ 250 ms OFF	OFF
Host Download	250 ms ON ↔ 250 ms OFF	OFF
Configuration Alignment	250 ms ON ↔ 250 ms OFF	OFF
Enter Service Mode	No Effect (remains Solid ON)	OFF
Short button press (1-5 s) Paging request	Blink Green 500 ms ON ↔ 500 ms OFF (for 5 s while pressing button)	OFF
Long button press (6-10 s) Flush Piconet request	Blink Green 1 s ON ↔ 1 s OFF (for 5 s while pressing button)	OFF
Charge in Progress	No Effect	Fading: 1 s ON ↔ 1 s OFF Green (charge = 50% - 99%) Amber (charge = 0% - 49%)
Charge Complete	No Effect	Solid Green It goes OFF when unplugged
Charge Fault	No Effect	OFF
Electrical Fault	OFF	OFF

PROGRAMMING MODE

The following indications **ONLY** occur when the scanner is in Programming Mode.

INDICATION	DESCRIPTION	LED	BEEPER
Enter Programming Mode	A valid programming label has been scanned.	LED blinks continuously	Scanner sounds four low frequency beeps.
Rejection of Label	Label has been rejected.	N/A	Scanner sounds three times at lowest frequency & current volume.
Acceptance of Partial Label	In cases where multiple labels must be scanned to program one feature, this indication acknowledges each portion as it is successfully scanned.	N/A	Scanner sounds one short beep at highest frequency & current volume.
Acceptance of Programming	Configuration option(s) have been successfully programmed via labels and the scanner has exited Programming Mode.	N/A	Scanner sounds one high frequency beep and four low frequency beeps followed by reset beeps.
Cancel Item Entry	Cancel label has been scanned.	N/A	Scanner sounds two times at low frequency & current volume.

TROUBLESHOOTING

PROBLEM	POSSIBLE CAUSE	POSSIBLE SOLUTION
Nothing happens when the scan button is pulled.	No power to the imager	Check system power. Ensure power supply is connected.
	Interface or power cables are loose.	Ensure all cable connections are secure.
LED comes on but bar code does not decode.	Imager not programmed for correct bar code type.	Ensure imager is programmed to read the type of bar code scanned. Refer to the PRG for more information.
	Bar code label is unreadable.	Check the label to ensure it is not defaced. Try scanning another bar code type.
	Distance between imager and bar code is incorrect.	Move imager closer to or further from the bar code.
Bar code is decoded but not transmitted to the host.	Imager not programmed for the correct host type.	Scan the appropriate host type bar code. Refer to the PRG for more information.

STANDARD CABLE PINOUTS

Figure 9 and Table 21 provide standard pinout information for the scanner’s cable.

Figure 26 Standard Cable Pinouts

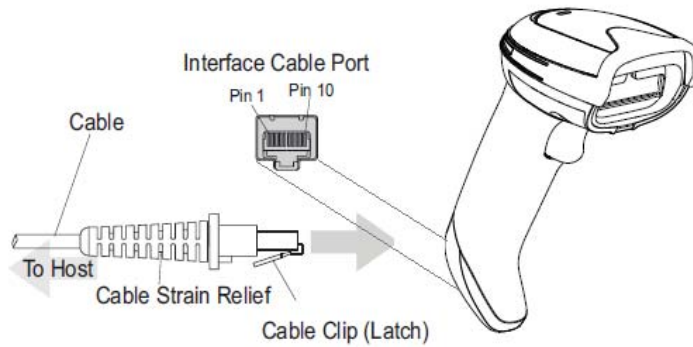

The signal descriptions in Table 21 apply to the connector on the scanner and are for reference only.

Table 33 Standard Cable Pinouts — Scanner Side

PIN	RS232	USB	KEYBOARD WEDGE
1	RTS (out)		
2		D+	CLKIN (KBD side)
3		D-	DATAIN (KBD side)
4	GND	GND	GND
5	RX		
6	TX		
7	VCC	VCC	VCC
8			CLKOUT (PC side)
9			DATAOUT (PC side)
10	CTS (in)		

APPENDIX B

STANDARD DEFAULTS

The most common configuration settings are listed in the “Default” column of the table below. Page references are also provided for feature descriptions and programming bar codes for each parameter. A column has also been provided for recording of your preferred default settings for these same configurable features.

Table 34 Standard Defaults

PARAMETERS	DEFAULT	YOUR SETTING	PAGE NUMBER
GLOBAL INTERFACE FEATURES			
Host Commands — Obey/Ignore	Obey		33
USB Suspend Mode	Enable		33
RS-232 ONLY			
Baud Rate	9600		35
Data Bits	8 Data Bits		36
Stop Bits	1 Stop Bit		36
Parity	None		37
Handshaking Control	RTS		38
RS-232/USB-COM			
Intercharacter Delay	No Delay		40
Beep On ASCII BEL	Disable		41
Beep On Not on File	Enable		41
ACK NAK Options	Disable		42
ACK Character	‘ACK’		43
NAK Character	‘NAK’		43
ACK NAK Timeout Value	200 ms		44
ACK NAK Retry Count	3 Retries		43
ACK NAK Error Handling	Ignore Errors Detected		45

STANDARD DEFAULTS

PARAMETERS	DEFAULT	YOUR SETTING	PAGE NUMBER
Indicate Transmission Failure	Enable		45
Disable Character	'D'		46
Enable Character	'E'		46
KEYBOARD WEDGE			
Setting Country Mode	U.S. Keyboard		49
Caps Lock State	Caps Lock OFF		71
Numlock	NumLock Key Unchanged		71
Keyboard Numeric Keypad	Standard Keys		72
Keyboard Send Control Characters	Send Ctrl+Key		72
Wedge Quiet Interval	10 = Quiet Interval of 100 ms		73
Intercharacter Delay	00 = No Intercharacter Delay		73
Intercode Delay	00 = No Wedge Intercode Delay		74
USB OEM			
USB-OEM Device Usage	Handheld		77
USB-OEM Interface Options	Ignore Scanner Configuration Host Commands		77
DATA FORMAT			
Global Prefix/Suffix	No Global Prefix Global Suffix = 0x0D (CR)		81
Global AIM ID	Disable		82
GS1-128 AIM ID	Disable		82
Label ID: Pre-loaded Sets	USA Set		83
Label ID Control	Disable		84
Label ID Symbology Selection			85
Case Conversion	Disable (no case conversion)		90
Character Conversion	0xFFFFFFFFFFFFFFFF (no character conversion)		90
READING PARAMETERS			
Scan Mode	0.6 Second		92
Scan Mode	Trigger Simple		92
Scanning Active Time	Disable		93

PARAMETERS	DEFAULT	YOUR SETTING	PAGE NUMBER
Flash On Time	10 = Flash is ON for 1 Second		93
Flash Off Time	06 = Flash is OFF for 600ms		94
Aiming Pointer	Enable		107
Beeper Control	Short (300 msec)		99
Power On Alert	Power On Alert = Power-up Beep		99
Good Read Beep Type	Mono		99
Good Read Beep Frequency	High		100
Good Read Beep Length	80 msec		101
Good Read Beep Volume	High		102
Good Read LED Duration	300 ms.		104
CODE SELECTION			
Code EAN/UPC			
Coupon Control	Enable only UPC/EAN		112
UPC-A			
UPC-A Enable/Disable	Enable		113
UPC-A Check Character Transmission	Send		113
Expand UPC-A to EAN-13	Don't expand		114
UPC-A Number System Character Transmission	Transmit		114
UPC-E			
UPC-E Enable/Disable	Enable		115
UPC-E Check Character Transmission	Send		115
Expand UPC-E to EAN-13	Don't expand		116
Expand UPC-E to UPC-A	Don't expand		116
UPC-E Number System Character Transmission	Transmit		116
GTIN			
GTIN Formatting	Disable		117
EAN 13 (Jan 13)			
EAN-13 Enable/Disable	Enable		118

PARAMETERS	DEFAULT	YOUR SETTING	PAGE NUMBER
EAN-13 Check Character Transmission	Send		118
EAN-13 Flag 1 Character	Transmit		119
EAN-13 to ISBN Conversion	Disable		119
ISSN			
EAN-13 to ISSN Conversion	Disable		120
EAN 8			
EAN-8 Enable/Disable	Enable		121
EAN-8 Check Character Transmission	Send		121
Expand EAN-8 to EAN-13	Disable		122
UPC/EAN Global Settings			
UPC/EAN Price Weight Check	Disable		123
UPC/EAN Quiet Zones			124
ADD-ONS			
Optional Add-ons	Disable P2, P5, P8		125
Optional Add-On Timer	70 ms		126
GS1 DATABAR™ OMNIDIRECTIONAL			
GS1 DataBar Omnidirectional Enable/Disable	Disable		127
GS1 DataBar Omnidirectional to GS1-128 Emulation	Disable		127
GS1 DataBar Expanded Enable/Disable	Disable		128
GS1 DataBar Expanded to GS1-128 Emulation	Disable		128
GS1 DataBar Expanded Length Control	Variable		129
GS1 DataBar Expanded Set Length 1	1		129
GS1 DataBar Expanded Set Length 2	74		130
GS1 DATABAR™ LIMITED			
GS1 DataBar Limited Enable/Disable	Disable		131
GS1 DataBar Limited to GS1-128 Emulation	Disable		131

PARAMETERS	DEFAULT	YOUR SETTING	PAGE NUMBER
CODE 39			
Code 39 Enable/Disable	Disable		132
Code 39 Check Character Calculation	Enable Check C and K		132
Code 39 Check Character Transmission	Disable		133
Code 39 Start/Stop Character Transmission	Variable		133
Code 39 Full ASCII	1		134
Code 39 Quiet Zones	Small Quiet Zones on two sides		134
Code 39 Length Control	Variable		135
Code 39 Set Length 1	1		135
Code 39 Set Length 2	50		136
CODE 32 (Italian Pharmaceutical Code)			
Code 32 Enable/Disable	Disable		139
Code 32 Check Character Transmission	Don't Send		139
Code 32 Start/Stop Character Transmission	Don't Transmit		140
CODE 39 CIP (French Pharmaceutical Code)			
Code 39 CIP Enable/Disable	Disable		140
SPECIAL CODES			
Code 128			
Code 128 Enable/Disable	Enable		141
Expand Code 128 to Code 39	Don't Expand		141
Code 128 Check Character Transmission	Don't Send		142
Code 128 Function Character Transmission	Don't Send		142
Code 128 Quiet Zones	Small Quiet Zones on two sides		143
Code 128 Length Control	Variable		143
Code 128 Set Length 1	1		144
Code 128 Set Length 2	80		144
GS1-128			
GS1-128 Enable	Transmit in Code 128 Data Format		145

PARAMETERS	DEFAULT	YOUR SETTING	PAGE NUMBER
INTERLEAVED 2 of 5			
I 2 of 5 Enable/Disable	Disable		146
I 2 of 5 Check Character Calculation	Disable		146
I 2 of 5 Check Character Transmission	Send		147
I 2 of 5 Length Control	Variable		148
I 2 of 5 Set Length 1	6		148
I 2 of 5 Set Length 2	30		149
INTERLEAVED 2 of 5 CIP HR			
Interleaved 2 of 5 CIP HR Enable/Disable	Disable		149
STANDARD 2 of 5			
Standard 2 of 5 Enable/Disable	Disable		150
Standard 2 of 5 Check Character Calculation	Disable		150
Standard 2 of 5 Check Character Transmission	Send		151
Standard 2 of 5 Length Control	Variable Length		151
Standard 2 of 5 Set Length 1	08 (8 characters)		152
Standard 2 of 5 Set Length 2	50 (50 characters)		152
COMPRESSED 2 of 5			
Compressed 2 of 5 Enable/Disable	Disable		153
Compressed 2 of 5 Check Character Calculation	Disable		153
Compressed 2 of 5 Check Character Transmission	Send		154
Compressed 2 of 5 Length Control	Variable Length		154
Compressed 2 of 5 Set Length 1	08 (8 characters)		155
Compressed 2 of 5 Set Length 2	50 (50 characters)		155
DATALOGIC 2 OF 5			
Datalogic 2 of 5 Enable/Disable	Disable		156
Datalogic 2 of 5 Check Character Calculation	Disable		156

PARAMETERS	DEFAULT	YOUR SETTING	PAGE NUMBER
Datalogic 2 of 5 Check Character Transmission	Send		157
Datalogic 2 of 5 Length Control	Variable Length		157
Datalogic 2 of 5 Set Length 1	1 = 06 (6 characters)		158
Datalogic 2 of 5 Set Length 2	50 (50 characters)		158
INDUSTRIAL 2 of 5			
Industrial 2 of 5 Enable/Disable	Disable		159
Industrial 2 of 5 Check Character Calculation	Disable		159
Industrial 2 of 5 Check Character Transmission	Don't Send		160
Industrial 2 of 5 Length Control	Variable		160
Industrial 2 of 5 Set Length 1	1 = 06 (6 characters)		161
Industrial 2 of 5 Set Length 2	2 = 50 (50 characters)		161
CODE IATA			
IATA Enable/Disable	Disable		162
IATA Check Character Transmission	Send		162
FOLLET 2 OF 5			
Follett 2 of 5 Enable/Disable	Disable		163
CODABAR			
Codabar Enable/Disable	Disable		164
Codabar Check Character Calculation	Disable		164
Codabar Check Character Transmission	Send		165
Codabar Start/Stop Character Transmission	Transmit		165
Codabar Start/Stop Character Set	abcd/abcd		166
Codabar Start/Stop Character Match	Don't Require Match		166
Codabar Quiet Zones	Quiet Zones on two sides		167
Codabar Length Control	Variable		168
Codabar Set Length 1	1 = 03 (3 characters)		168
Codabar Set Length 2	2 = 50 (50 characters)		169
ABC CODABAR			

PARAMETERS	DEFAULT	YOUR SETTING	PAGE NUMBER
ABC Codabar Enable/Disable	Disable		170
ABC Codabar Concatenation Mode	Static		170
ABC Codabar Dynamic Concatenation Timeout	20 (20 ms)		171
ABC Codabar Force Concatenation	Disable		171
ISBT-128			
ISBT 128 Concatenation	Disable		172
ISBT 128 Concatenation Mode	Static		172
ISBT 128 Dynamic Concatenation Timeout	200 msec		173
ISBT 128 Force Concatenation	Disable		174
CODE 11			
Code 11 Enable/Disable	Disable		175
Code 11 Check Character Calculation	Check C and K		175
Code 11 Check Character Transmission	Send		176
Code 11 Length Control	Variable		176
Code 11 Set Length 1	04 (4 characters)		177
Code 11 Set Length 2	50 (50 characters)		177
CODE 93			
Code 93 Enable/Disable	Disable		178
Code 93 Check Character Calculation	Enable Check C and K		178
Code 93 Check Character Transmission	Disable		179
Code 93 Length Control	Variable		179
Code 93 Set Length 1	1		180
Code 93 Set Length 2	50		180
Code 93 Quiet Zones	Small Quiet Zones on two sides		181
MSI			
MSI Enable/Disable	Disable		182
MSI Check Character Calculation	Enable Mod10		182
MSI Check Character Transmission	Enable		183
MSI Length Control	Variable		183

PARAMETERS	DEFAULT	YOUR SETTING	PAGE NUMBER
MSI Set Length 1	1		184
MSI Set Length 2	50		184
PLESSEY			
Plessey Enable/Disable	Disable		185
Plessey Check Character Calculation	Plessey std check char. verification		185
Plessey Check Character Transmission	Send		186
Plessey Length Control	Variable		186
Plessey Set Length 1	01 (one character)		187
Plessey Set Length 2	50 (50 characters)		187
BC412			
BC412 Enable/Disable	Disable		188
BC412 Check Character Calculation	Calculate		188
BC412 Length Control	Variable		189
BC412 Set Length 1	01 (one character)		190
BC412 Set Length 2	50 (50 characters)		190

DEFAULT EXCEPTIONS

Table 35 - Default Exceptions by Interface Type

PARAMETER	DEFAULT EXCEPTION
Interfaces: USB-OEM	
Global Suffix	No Global Suffix
Double Read Timeout	500 msec
Interfaces: All Keyboard Wedge, USB Keyboard	
No unique settings	
Interface: RS232-WN	
Expand UPC-A to EAN-13	Enable
UPC-E Check Character Transmission	Disable
Parity	Odd Parity
Handshaking Control	RTS/CTS
Transmission Label ID Code	Prefix
GS1-128 AIM ID	Disable
UPCE Label ID Character(s)	C
EAN 8 Label ID Character(s)	B
EAN 13 Label ID Character(s)	A
Code ISBN Label ID Character(s)	A
Code 39 Label ID Character(s)	M
MInterleaved 2of5 Label ID Character(s)	I
Code Standard 2/5 Label ID Character(s)	H
Codabar Label ID Character(s)	N
Code 128 Label ID Character(s)	K
GS1-128 Label ID Character(s)	P
Datalogic 2 of 5 Label ID Character(s)	H
ISBT 128 Label ID Character(s)	K
UPCE P2 Label ID Character(s)	C
UPCE/P5 Label ID Character(s)	C
UPCE/GS1-128 Label ID Character(s)	C
EAN8/P2 Label ID Character(s)	B
EAN8/P5 Label ID Character(s)	B
EAN8/GS1-128 Label ID Character(s)	B
EAN13/P2 Label ID Character(s)	A
EAN13/P5 Label ID Character(s)	A
EAN13/GS1-128 Label ID Character(s)	A

PARAMETER	DEFAULT EXCEPTION
GS1 DataBar 14 (Omnidirectional) Label ID Character(s)	E
GS1 DataBar Expanded Label ID Character(s)	E
GS1 DataBar Limited Label ID Character(s)	E
Character Conversion	CR to `
Interface: RS232-OPOS	
Baud Rate	115200 Baud
Transmission Label ID Code	Prefix
GS1-128 AIM ID	Disable
UPCA Label ID Character(s)	C
UPCE Label ID Character(s)	D
EAN 8 Label ID Character(s)	A
EAN 13 Label ID Character(s)	B
Code ISBN Label ID Character(s)	@
Code 39 Label ID Character(s)	V
Code 32 Label ID Character(s)	X
Interleaved 2of5 Label ID Character(s)	N
Code Standard 2/5 Label ID Character(s)	P
Codabar Label ID Character(s)	R
Code 11 Label ID Character(s)	b
Code 128 Label ID Character(s)	T
GS1-128 Label ID Character(s)	k
UPCA/P2 Label ID Character(s)	F
UPCA/P5 Label ID Character(s)	G
UPCA/GS1-128 Label ID Character(s)	Q
UPCE P2 Label ID Character(s)	H
UPCE/P5 Label ID Character(s)	I
EAN8/P2 Label ID Character(s)	J
EAN8/P5 Label ID Character(s)	K
EAN8/GS1-128 Label ID Character(s)	*
EAN13/P2 Label ID Character(s)	L
EAN13/P5 Label ID Character(s)	M
EAN13/GS1-128 Label ID Character(s)	#
GS1 DataBar 14 (Omnidirectional) Label ID Character(s)	u
GS1 DataBar Expanded Label ID Character(s)	t
GS1 DataBar Limited Label ID Character(s)	v

APPENDIX C

SAMPLE BARCODES

The sample bar codes in this appendix are typical representations for their symbology types.

SAMPLE BARCODES

1D Barcodes

UPC-A

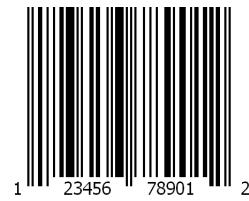

EAN-13



Code 39



Code 128



Interleaved 2 of 5



Code 32



Codabar



Code 93



Code 11



GS1 Databar™ (RSS)

GS1 DataBar™ variants must be enabled to read the barcodes below (see "GS1 DataBar™ Omnidirectional" on page 127).

GS1 DataBar™ Expanded



1234890hjjio9900mnb

GS1 DataBar™ Limited



08672345650916

GS1 Databar™ (-14)

GS1 DataBar™ Omnidirectional Truncated



55432198673467

APPENDIX D

KEYPAD

Use the bar codes in this appendix to enter numbers as you would select digits/characters from a keypad.



1

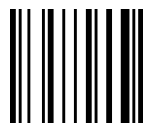

2



3



4



5

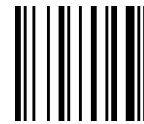

6



7



1



2



3



4



5



6



7



8



9

APPENDIX E

SCANCODE TABLES

CONTROL CHARACTER EMULATION

Control character emulation selects from different scancode tables as listed in this appendix. Each of the control character sets below are detailed by interface type in the tables. These apply to Wedge and USB Keyboard platforms.

Control Character 00 : Characters from 00 to 0x1F are sent as control character Ctrl+Keys, special keys are located from 0x80 to 0xA1.

Control Character 01 : Characters from 00 to 0x1F are sent as control character Ctrl+Capital Key, special keys are located from 0x80 to 0xA1.

Control Character 02 : Special keys are located from 00 to 0x1F and characters from 0x80 to 0xFE are intended as an extended ASCII table (Microsoft Windows Codepage 1252 — see [page 285](#)).

Single Press and Release Keys

In the following tables, Ar↓ means Alt right pressed and Ar↑ means Alt right released and so on. Definitions for other keys are Al (Alt left), Cr (Control Right) Cl (Control Left) Sh (shift). This method can be used for combining Alt, Control or Shift with other keys.

Example: Consider a Control character set to 00. If AltRight+A is required before sending a label to the host, it could be done by setting three Prefix keys in this way: 0x99 0x41 0x9A.

INTERFACE TYPE PC AT PS/2, USB-KEYBOARD OR USB-KEYBOARD FOR APPLE

Table 36. Scancode Set When Control Character is 00 or 01

	x0	x1	x2	x3	x4	x5	x6	x7	x8	x9	xA	xB	xC	xD	xE	xF
0x	NULL C+@	SOH C(S)+A	STX C(S)+B	ETX C(S)+C	EOT C(S)+D	ENQ C(S)+E	ACK C(S)+F	BEL C(S)+G	BS CAN C(S)+X	HT TAB EM C(S)+Y	LF C(S)+J SUB C(S)+Z	VT C(S)+K ESC Esc	FF C(S)+L FS C+]	CR Enter GS C+]	SO C(S)+N RS C+^	SI C(S)+O US C(S)+_
1x	DLE C(S)+P	DC1 C(S)+Q	DC2 C(S)+R	DC3 C(S)+S	DC4 C(S)+T	NAK C(S)+U	SYN C(S)+V	ETB C(S)+W								
2x	SP	!	"	#	\$	%	&	'	()	*	+	,	-	.	/
3x	0	1	2	3	4	5	6	7	8	9	:	;	<	=	>	?
4x	@	A	B	C	D	E	F	G	H	I	J	K	L	M	N	O
5x	P	Q	R	S	T	U	V	W	X	Y	Z	[\]	^	_
6x	,	a	b	c	d	e	f	g	h	i	j	k	l	m	n	o
7x	p	q	r	s	t	u	v	w	x	y	z	{		}	~	Del
8x	€	Sh↓	Sh↑	Ins	Ent (keyp)	F1	F2	F3	F4	F5	F6	F7	F8	F9	F10	F11
9x	F12	Home	End	Pg Up	Pg Dwn	↑	↓	←	→	Ar↓	Ar↑	Al↓	Al↑	Cl↓	Cl↑	Cr↓
Ax	Cr↑		'	<i>f</i>	"	...	†	‡	^	%	Š	<	Š	<	Œ	
Bx	°	±	²	³	'	μ	¶	·	,	ı	°	»	¼	½	¾	ı
Cx	À	Á	Â	Ã	Ä	Å	Æ	Ç	È	É	Ê	Ë	Ì	Í	Î	Ï
Dx	Ð	Ñ	Ò	Ó	Ô	Õ	Ö	×	Ø	Ù	Ú	Û	Ü	Ý	Þ	ß
Ex	à	á	â	ã	ä	å	æ	ç	è	é	ê	ë	ì	í	î	ï
Fx	ð	ñ	ò	ó	ô	õ	ö	÷	ø	ù	ú	û	ü	ý	þ	ÿ

Extended characters (sky blue) are sent through dedicated keys (when available in the selected country mode) or by using an Alt Mode sequence.

INTERFACE TYPE PC AT PS/2, USB-KEYBOARD OR USB-KEYBOARD FOR APPLE (CONTINUED)

Table 37. Scancode Set When Control Character is 02

	x0	x1	x2	x3	x4	x5	x6	x7	x8	x9	xA	xB	xC	xD	xE	xF
0x	Ar↓	Ar↑	Al↓	Al↑	Cl↓	Cl↑	Cr↓	Cr↑	BS	Tab	→	S+Tab	Enter Keypd	Enter	Ins	Pg Up
1x	Pg Dwn	Home	←	↓	↑	F6	F1	F2	F3	F4	F5	ESC	F7	F8	F9	F10
2x	Space	!	“	#	\$	%	&	‘	()	*	+	,	-	.	/
3x	0	1	2	3	4	5	6	7	8	9	:	;	<	=	>	?
4x	@	A	B	C	D	E	F	G	H	I	J	K	L	M	N	O
5x	P	Q	R	S	T	U	V	W	X	Y	Z	[\]	^	_
6x	`	a	b	c	d	e	f	g	h	i	j	k	l	m	n	o
7x	p	q	r	s	t	u	v	w	x	y	z	{		}	~	Del
8x	€	‘	’	ƒ	”	…	†	‡	^	% ₀₀	Š	<	Ś	<	Œ	
9x		‚	“	“	”	•	—	—	~	™	š	>	œ		ž	ÿ
Ax	NBSP	ı	ø	£	□	¥	ı	§	“	©	ª	«	¬	-	®	-
Bx	°	±	²	³	´	µ	¶	·	¸	¹	º	»	¼	½	¾	¿
Cx	À	Á	Â	Ã	Ä	Å	Æ	Ç	È	É	Ê	Ë	Ì	Í	Î	Ï
Dx	Ð	Ò	Ó	Ô	Õ	Ö	Ø	×	Ù	Ú	Û	Ü	Ý	Þ	ß	
Ex	à	á	â	ã	ä	å	æ	ç	è	é	ê	ë	ì	í	î	ï
Fx	ð	ñ	ò	ó	ô	õ	ö	÷	ø	ù	ú	û	ü	ý	þ	ÿ

INTERFACE TYPE PC AT PS/2 ALT MODE OR USB-KEYBOARD ALT MODE

Table 38. Scancode Set When Control Character is 00 or 01

	x0	x1	x2	x3	x4	x5	x6	x7	x8	x9	xA	xB	xC	xD	xE	Xf
0x	Alt+000	Alt+001	Alt+002	Alt+003	Alt+004	Alt+005	Alt+006	Alt+007	BS	HT TAB	Alt+010	Alt+011	Alt+012	CR Enter	Alt+014	Alt+015
1x	Alt+016	Alt+017	Alt+018	Alt+019	Alt+020	Alt+021	Alt+022	Alt+023	Alt+024	Alt+025	Alt+026	ESC Esc	Alt+028	Alt+029	Alt+030	Alt+031
2x	A+032	A+033	A+034	A+035	A+036	A+037	A+038	A+039	A+040	A+041	A+042	A+043	A+044	A+045	A+046	A+047
3x	A+048	A+049	A+050	A+051	A+052	A+053	A+054	A+055	A+056	A+057	A+058	A+059	A+060	A+061	A+062	A+063
4x	A+064	A+065	A+066	A+067	A+068	A+069	A+070	A+071	A+072	A+073	A+074	A+075	A+076	A+077	A+078	A+079
5x	A+080	A+081	A+082	A+083	A+084	A+085	A+086	A+087	A+088	A+089	A+090	A+091	A+092	A+093	A+094	A+095
6x	A+096	A+097	A+098	A+099	A+100	A+101	A+102	A+103	A+104	A+105	A+106	A+107	A+108	A+109	A+110	A+111
7x	A+112	A+113	A+114	A+115	A+116	A+117	A+118	A+119	A+120	A+121	A+122	A+123	A+124	A+125	A+126	A+127
8x	€	Sh↓	Sh↑	Ins	Ent (keyp)	F1	F2	F3	F4	F5	F6	F7	F8	F9	F10	F11
9x	F12	Home	End	Pg Up	Pg Dwn	↑	↓	←	→	Ar↓	Ar↑	Al↓	Al↑	Cl↓	Cl↑	Cr↓
Ax	Cr↑	A+0161	A+0162	A+0163	A+0164	A+0165	A+0166	A+0167	A+0168	A+0169	A+0170	A+0171	A+0172	A+0173	A+0174	A+0175
Bx	A+0176	A+0177	A+0178	A+0179	A+0180	A+0181	A+0182	A+0183	A+0184	A+0185	A+0186	A+0187	A+0188	A+0189	A+0190	A+0191
Cx	A+0192	A+0193	A+0194	A+0195	A+0196	A+0197	A+0198	A+0199	A+0200	A+0201	A+0202	A+0203	A+0204	A+0205	A+0206	A+0207
Dx	A+0208	A+0209	A+0210	A+0211	A+0212	A+0213	A+0214	A+0215	A+0216	A+0217	A+0218	A+0219	A+0220	A+0221	A+0222	A+0223
Ex	A+0224	A+0225	A+0226	A+0227	A+0228	A+0229	A+0230	A+0231	A+0232	A+0233	A+0234	A+0235	A+0236	A+0237	A+0238	A+0239
Fx	A+0240	A+0241	A+0242	A+0243	A+0244	A+0245	A+0246	A+0247	A+0248	A+0249	A+0250	A+0251	A+0252	A+0253	A+0254	A+0255

INTERFACE TYPE PC AT PS/2 ALT MODE OR USB-KEYBOARD ALT MODE (CONTINUED)

Table 39. Scancode Set When Control Character is 02

	x0	x1	x2	x3	x4	x5	x6	x7	x8	x9	xA	xB	xC	xD	xE	xF
0x	Ar↓	Ar↑	Al↓	Al↑	Cl↓	Cl↑	Cr↓	Cr↑	BS	Tab	→	S+ Tab	Enter Keyprd	Enter	Ins	Pg Up
1x	Pg Dwn	Home	←	→	↑	F6	F1	F2	F3	F4	F5	ESC	F7	F8	F9	F10
2x	A+032	A+033	A+034	A+035	A+036	A+037	A+038	A+039	A+040	A+041	A+042	A+043	A+044	A+045	A+046	A+047
3x	A+048	A+049	A+050	A+051	A+052	A+053	A+054	A+055	A+056	A+057	A+058	A+059	A+060	A+061	A+062	A+063
4x	A+064	A+065	A+066	A+067	A+068	A+069	A+070	A+071	A+072	A+073	A+074	A+075	A+076	A+077	A+078	A+079
5x	A+080	A+081	A+082	A+083	A+084	A+085	A+086	A+087	A+088	A+089	A+090	A+091	A+092	A+093	A+094	A+095
6x	A+096	A+097	A+098	A+099	A+100	A+101	A+102	A+103	A+104	A+105	A+106	A+107	A+108	A+109	A+110	A+111
7x	A+112	A+113	A+114	A+115	A+116	A+117	A+118	A+119	A+120	A+121	A+122	A+123	A+124	A+125	A+126	A+127
8x	A+0128	A+0129	A+0130	A+0131	A+0132	A+0133	A+0134	A+0135	A+0136	A+0137	A+0138	A+0139	A+0140	A+0141	A+0142	A+0143
9x	A+0144	A+0145	A+0146	A+0147	A+0148	A+0149	A+0150	A+0151	A+0152	A+0153	A+0154	A+0155	A+0156	A+0157	A+0158	A+0159
Ax	A+0160	A+0161	A+0162	A+0163	A+0164	A+0165	A+0166	A+0167	A+0168	A+0169	A+0170	A+0171	A+0172	A+0173	A+0174	A+0175
Bx	A+0176	A+0177	A+0178	A+0179	A+0180	A+0181	A+0182	A+0183	A+0184	A+0185	A+0186	A+0187	A+0188	A+0189	A+0190	A+0191
Cx	A+0192	A+0193	A+0194	A+0195	A+0196	A+0197	A+0198	A+0199	A+0200	A+0201	A+0202	A+0203	A+0204	A+0205	A+0206	A+0207
Dx	A+0208	A+0209	A+0210	A+0211	A+0212	A+0213	A+0214	A+0215	A+0216	A+0217	A+0218	A+0219	A+0220	A+0221	A+0222	A+0223
Ex	A+0224	A+0225	A+0226	A+0227	A+0228	A+0229	A+0230	A+0231	A+0232	A+0233	A+0234	A+0235	A+0236	A+0237	A+0238	A+0239
Fx	A+0240	A+0241	A+0242	A+0243	A+0244	A+0245	A+0246	A+0247	A+0248	A+0249	A+0250	A+0251	A+0252	A+0253	A+0254	A+0255

DIGITAL INTERFACE

Table 40. Scancode Set When Control Character is 00 or 01

	X0	X1	X2	X3	X4	X5	X6	X7	X8	X9	xA	xB	xC	xD	xE	xF
0x	NULL C+@	SOH C(S)+A	STX C(S)+B	ETX C(S)+C	EOT C+D	ENQ C(S)+E	ACK C(S)+F	BEL C(S)+G	BS	HT TAB	LF C(S)+J	VT C(S)+K	FF C(S)+L	CR Enter	SO C(S)+N	SI C(S)+O
1x	DLE C(S)+P	DC1 C(S)+Q	DC2 C(S)+R	DC3 C(S)+S	DC4 C(S)+T	NAK C(S)+U	SYN C(S)+V	ETB C(S)+W	CAN C(S)+X	EM C(S)+Y	SUB C(S)+Z	ESC Esc	FS C(S)+\	GS C+]	RS C(S)+^	US C(S)+_
2x	Space	!	“	#	\$	%	&	'	()	*	+	,	-	.	/
3x	0	1	2	3	4	5	6	7	8	9	:	;	<	=	>	?
4x	@	A	B	C	D	E	F	G	H	I	J	K	L	M	N	O
5x	P	Q	R	S	T	U	V	W	X	Y	Z	[\]	^	_
6x	`	a	b	c	d	e	f	g	h	i	j	k	l	m	n	o
7x	p	q	r	s	t	u	v	w	x	y	z	{		}	~	Del
8x		Sh↓	Sh↑	Ins	Ent (keyp)	F1	F2	F3	F4	F5	F6	F7	F8	F9	F10	F11
9x	F12	F13	F14	F15	F16	↑	↓	←	→					Cl↓	Cl↑	

Table 41. Scancode Set When Control Character is 02

	X0	X1	X2	X3	X4	X5	X6	X7	X8	X9	xA	xB	xC	xD	xE	xF
0x					Cl↓	Cl↑			BS	Tab	à	S+ Tab	Enter Keyprd	Enter	Ins	
1x			←	↓	↑	F6	F1	F2	F3	F4	F5	ESC	F7	F8	F9	F10
2x	Space	!	“	#	\$	%	&	'	()	*	+	,	-	.	/
3x	0	1	2	3	4	5	6	7	8	9	:	;	<	=	>	?
4x	@	A	B	C	D	E	F	G	H	I	J	K	L	M	N	O
5x	P	Q	R	S	T	U	V	W	X	Y	Z	[\]	^	_
6x	`	a	b	c	d	e	f	g	h	i	j	k	l	m	n	o
7x	p	q	r	s	t	u	v	w	x	y	z	{		}	~	Del

IBM31XX 102-KEY

Table 42. Scancode Set When Control Character is 00 or 01

	x0	x1	x2	x3	x4	x5	x6	x7	x8	x9	xA	xB	xC	xD	xE	xF
0x	NULL C+@	SOH C(S)+A	STX C(S)+B	ETX C(S)+C	EOT C+D	ENQ C(S)+E	ACK C(S)+F	BEL C(S)+G	BS	HT TAB	LF C(S)+J	VT C(S)+K	FF C(S)+L	CR Enter	SO C(S)+N	SI C(S)+O
1x	DLE C(S)+P	DC1 C(S)+Q	DC2 C(S)+R	DC3 C(S)+S	DC4 C(S)+T	NAK C(S)+U	SYN C(S)+V	ETB C(S)+W	CAN C(S)+X	EM C(S)+Y	SUB C(S)+Z	ESC Esc	FS C(S)+\	GS C+]	RS C(S)+^	US C(S)+_
2x	Space	!	“	#	\$	%	&	'	()	*	+	,	-	.	/
3x	0	1	2	3	4	5	6	7	8	9	:	;	<	=	>	?
4x	@	A	B	C	D	E	F	G	H	I	J	K	L	M	N	O
5x	P	Q	R	S	T	U	V	W	X	Y	Z	[\]	^	_
6x	,	a	B	c	d	e	f	g	h	i	j	k	l	m	n	o
7x	p	q	R	s	t	u	v	w	x	y	z	{		}		Del
8x		Sh↓	Sh↑	Ins	Ent (keyp)	F1	F2	F3	F4	F5	F6	F7	F8	F9	F10	F11
9x	F12	Enter	Reset	Insert	Delete	Field -	Field +	Enter paddle	Printl	Ar↓	Ar↑	Al↓	Al↑	Cl↓	Cl↑	Cr↓
Ax	Cr↑															

Table 43. Scancode Set When Control Character is 02

	X0	X1	X2	X3	X4	X5	X6	X7	X8	X9	xA	xB	xC	xD	xE	xF
0x	Ar↓	Ar↑	Al↓	Al↑	Cl↓	Cl↑	Cr↓	Cr↑	BS	Tab	→	S+ Tab	Enter Keyupd	Enter	Ins	Pg Up
1x	Pg Dwn	Home	←	↓	↑	F1	F2	F3	F4	F5	F5	ESC	F7	F8	F9	F10
2x	Space	!	“	#	\$	&	,	()	*	+	+	,	-	.	/
3x	0	1	2	3	4	6	7	8	9	:	;	;	<	=	>	?
4x	@	A	B	C	D	F	G	H	I	J	K	K	L	M	N	O
5x	P	Q	R	S	T	V	W	X	Y	Z	[[\]	^	_
6x	,	a	B	c	d	f	g	h	i	j	k	k	l	m	n	o
7x	p	q	R	s	t	v	w	x	y	z	{	{		}		Del

IBM XT

Table 44. Scancode Set When Control Character is 00 or 01

	x0	x1	x2	x3	x4	x5	x6	x7	x8	x9	xA	xB	xC	xD	xE	xF
0x	NULL C+@	SOH C(S)+A	STX C(S)+B	ETX C(S)+C	EOT C+D	ENQ C(S)+E	ACK C(S)+F	BEL C(S)+G	BS C(S)+H	HT TAB	LF C(S)+J	VT C(S)+K	FF C(S)+L	CR Enter	SO C(S)+N	SI C(S)+O
1x	DLE C(S)+P	DC1 C(S)+Q	DC2 C(S)+R	DC3 C(S)+S	DC4 C(S)+T	NAK C(S)+U	SYN C(S)+V	ETB C(S)+W	CAN C(S)+X	EM C(S)+Y	SUB C(S)+Z	ESC Esc	FS C(S)+\	GS C+]	RS C(S)+^	US C(S)+_
2x	Space	!	“	#	\$	%	&	'	()	*	+	,	-	.	/
3x	0	1	2	3	4	5	6	7	8	9	:	;	<	=	>	?
4x	@	A	B	C	D	E	F	G	H	I	J	K	L	M	N	O
5x	P	Q	R	S	T	U	V	W	X	Y	Z	[\]	^	_
6x	,	a	B	c	d	e	f	g	h	i	j	k	l	m	n	o
7x	p	q	R	s	t	u	v	w	x	y	z	{		}		Del
8x		Sh↓	Sh↑	Ins	Ent (keyp)	F1	F2	F3	F4	F5	F6	F7	F8	F9	F10	F11
9x	F12	Home	End	Pg Up	Pg Dwn	↑	↓	←	→	Ar↓	Ar↑	Alt↓	Alt↑	Ctrl↓	Ctrl↑	Cr↓
Ax	Cr↑															

Table 45. Scancode Set when Control Character 02

	X0	X1	X2	X3	X4	X5	X6	X7	X8	X9	xA	xB	xC	xD	xE	xF
0x	Ar↓	Ar↑	Al↓	Al↑	Cl↓	Cl↑	Cr↓	Cr↑	BS	Tab	→	S+ Tab	Enter Keypd	Enter	Ins	Pg Up
1x	Pg Dwn	Home	←	↓	↑	F6	F1	F2	F3	F4	F5	ESC	F7	F8	F9	F10
2x	Space	!	“	#	\$	%	&	‘	()	*	+	,	-	.	/
3x	0	1	2	3	4	5	6	7	8	9	:	;	<	=	>	?
4x	@	A	B	C	D	E	F	G	H	I	J	K	L	M	N	O
5x	P	Q	R	S	T	U	V	W	X	Y	Z	[\]	^	_
6x	,	a	B	c	d	e	f	g	h	i	j	k	l	m	n	o
7x	p	q	R	s	t	u	v	w	x	y	z	{		}		Del

MICROSOFT WINDOWS CODEPAGE 1252

Windows-1252 is a character encoding of the Latin alphabet, used by default in the legacy components of Microsoft Windows in English and some other Western languages.

	00	01	02	03	04	05	06	07	08	09	0A	0B	0C	0D	0E	0F
00	NUL 0000	STX 0001	SOT 0002	ETX 0003	EOT 0004	ENO 0005	ACK 0006	BEL 0007	BS 0008	HT 0009	LF 000A	VT 000B	FF 000C	CR 000D	SO 000E	SI 000F
10	DLE 0010	DC1 0011	DC2 0012	DC3 0013	DC4 0014	NAK 0015	SYN 0016	ETB 0017	CAN 0018	EM 0019	SUB 001A	ESC 001B	PS 001C	GS 001D	RS 001E	US 001F
20	SP 0020	! 0021	" 0022	# 0023	\$ 0024	% 0025	& 0026	* 0027	(0028) 0029	* 002A	+ 002B	, 002C	- 002D	. 002E	/ 002F
30	0 0030	1 0031	2 0032	3 0033	4 0034	5 0035	6 0036	7 0037	8 0038	9 0039	: 003A	; 003B	< 003C	= 003D	> 003E	? 003F
40	@ 0040	A 0041	B 0042	C 0043	D 0044	E 0045	F 0046	G 0047	H 0048	I 0049	J 004A	K 004B	L 004C	M 004D	N 004E	O 004F
50	P 0050	Q 0051	R 0052	S 0053	T 0054	U 0055	V 0056	W 0057	X 0058	Y 0059	Z 005A	[005B	\ 005C] 005D	^ 005E	_ 005F
60	` 0060	a 0061	b 0062	c 0063	d 0064	e 0065	f 0066	g 0067	h 0068	i 0069	j 006A	k 006B	l 006C	m 006D	n 006E	o 006F
70	p 0070	q 0071	r 0072	s 0073	t 0074	u 0075	v 0076	w 0077	x 0078	y 0079	z 007A	{ 007B	 007C	} 007D	~ 007E	DEL 007F
80	€ 20AC	• 20A2	ƒ 201A	£ 0132	„ 201E	… 2026	† 2020	‡ 2021	ˆ 02C5	‰ 2030	Š 0160	< 2038	€ 0162	• 017D	Ž 017D	• 017D
90	• 2018	ˆ 2019	˜ 201C	˘ 201D	• 2022	– 2013	— 2014	ˆ 02DC	™ 2122	Š 0161	› 203A	€ 0163	• 017E	Ž 017E	Ÿ 0178	• 0178
A0	NSP 00A0	ı 00A1	ı 00A2	£ 00A3	× 00A4	¥ 00A5	ı 00A6	§ 00A7	• 00A8	© 00A9	• 00AA	« 00AB	¬ 00AC	– 00AD	® 00AE	— 00AF
B0	° 00B0	± 00B1	² 00B2	³ 00B3	´ 00B4	µ 00B5	¶ 00B6	· 00B7	¸ 00B8	¹ 00B9	º 00BA	» 00BB	¼ 00BC	½ 00BD	¾ 00BE	¿ 00BF
C0	À 00C0	Á 00C1	Â 00C2	Ã 00C3	Ä 00C4	Å 00C5	Æ 00C6	Ç 00C7	È 00C8	É 00C9	Ê 00CA	Ë 00CB	Ì 00CC	Í 00CD	Î 00CE	Ï 00CF
D0	Ð 00D0	Ñ 00D1	Ò 00D2	Ó 00D3	Ô 00D4	Õ 00D5	Ö 00D6	× 00D7	Ø 00D8	Ù 00D9	Ú 00DA	Û 00DB	Ü 00DC	Ý 00DD	Þ 00DE	ß 00DF
E0	à 00E0	á 00E1	â 00E2	ã 00E3	ä 00E4	å 00E5	æ 00E6	ç 00E7	è 00E8	é 00E9	ê 00EA	ë 00EB	ì 00EC	í 00ED	î 00EE	ï 00EF
F0	ø 00F0	ñ 00F1	ò 00F2	ó 00F3	ô 00F4	õ 00F5	ö 00F6	÷ 00F7	ø 00F8	ù 00F9	ú 00FA	û 00FB	ü 00FC	ý 00FD	þ 00FE	ÿ 00FF

APPENDIX F

ASCII CHART

ASCII Char.	Hex No.	ASCII Char.	Hex No.	ASCII Char.	Hex No.	ASCII Char.	Hex No.
NUL	00	SP	20	@	40	'	60
SOH	01	!	21	A	41	a	61
STX	02	"	22	B	42	b	62
ETX	03	#	23	C	43	c	63
EOT	04	\$	24	D	44	d	64
ENQ	05	%	25	E	45	e	65
ACK	06	&	26	F	46	f	66
BEL	07	'	27	G	47	g	67
BS	08	(28	H	48	h	68
HT	09)	29	I	49	i	69
LF	0A	*	2A	J	4A	j	6A
VT	0B	+	2B	K	4B	k	6B
FF	0C	,	2C	L	4C	l	6C
CR	0D	-	2D	M	4D	m	6D
SO	0E	.	2E	N	4E	n	6E
SI	0F	/	2F	O	4F	o	6F
DLE	10	0	30	P	50	p	70
DC1	11	1	31	Q	51	q	71
DC2	12	2	32	R	52	r	72
DC3	13	3	33	S	53	s	73
DC4	14	4	34	T	54	t	74
NAK	15	5	35	U	55	u	75
SYN	16	6	36	V	56	v	76
ETB	17	7	37	W	57	w	77
CAN	18	8	38	X	58	x	78
EM	19	9	39	Y	59	y	79
SUB	1A	:	3A	Z	5A	z	7A
ESC	1B	;	3B	[5B	{	7B
FS	1C	<	3C	\	5C		7C
GS	1D	=	3D]	5D	}	7D
RS	1E	>	3E	^	5E	~	7E
US	1F	?	3F	_	5F	DEL	7F

© 2011-2020 Datalogic S.p.A. and /or its affiliates • All rights reserved • Without limiting the rights under copyright, no part of this documentation may be reproduced, stored in or introduced into a retrieval system, or transmitted in any form or by any means, or for any purpose, without the express written permission of Datalogic S.p.A. and/or its affiliates • Datalogic and the Datalogic logo are registered trademarks of Datalogic S.p.A. in many countries, including the U.S. and the E.U.



Datalogic S.r.l.

Via S. Vitalino, 13 | 40012 Calderara di Reno | Bologna - Italy
Tel. +39 051 3147011 | Fax +39 051 3147205

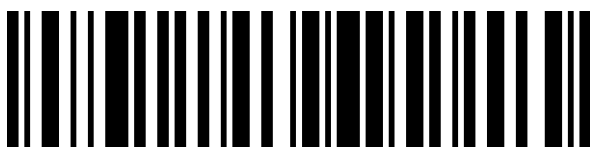

820119500

(Rev A)

September 2020