

Honeywell

Dolphin™ 6000

with Windows Mobile® 6.5

User's Guide

Disclaimer

Honeywell International Inc. ("HII") reserves the right to make changes in specifications and other information contained in this document without prior notice, and the reader should in all cases consult HII to determine whether any such changes have been made. The information in this publication does not represent a commitment on the part of HII.

HII shall not be liable for technical or editorial errors or omissions contained herein; nor for incidental or consequential damages resulting from the furnishing, performance, or use of this material.

This document contains proprietary information that is protected by copyright. All rights are reserved. No part of this document may be photocopied, reproduced, or translated into another language without the prior written consent of HII.

© 2011-2012 Honeywell International Inc. All rights reserved.

Other product names or marks mentioned in this document may be trademarks or registered trademarks of other companies and are the property of their respective owners.

Web Address: www.honeywellaidc.com

Trademarks

Dolphin is a trademark or registered trademark of Hand Held Products, Inc. or Honeywell International Inc.

Microsoft, Windows, Windows Mobile, Windows CE, Windows 98 Second Edition, Windows NT, Windows 2000, Windows ME, Windows XP, ActiveSync, Outlook, and the Windows logo are trademarks or registered trademarks of Microsoft Corporation.

The Bluetooth trademarks are owned by Bluetooth SIG, Inc., U.S.A. and licensed to Honeywell.

Other product names mentioned in this manual may be trademarks or registered trademarks of their respective companies and are the property of their respective owners.

Patents

For patent information, please refer to www.honeywellaidc.com/patents.



Table of Contents

Chapter 1 - Agency Information

Label Locations	1-1
Laser Safety Label	1-1
Laser Safety Statement	1-1
LED Safety Statement	1-2
UL and C-UL Statement.....	1-2
CB Safety Statement	1-2
FCC.....	1-2
Industry Canada (ICES-003).....	1-2
RF Exposure Information (SAR)	1-3
For European Community Users	1-3
Waste Electrical and Electronic Equipment Information	1-3
Pacemakers, Hearing Aids and Other Electrically Powered Devices	1-3
China RoHS	1-4
Operating Temperature.....	1-4
Approvals by Country.....	1-4

Chapter 2 - Getting Started

Out of the Box	2-1
Installing Battery Pack	2-1
Removing Battery Pack	2-1
Charging the Batteries	2-2
Before Initial Use.....	2-2
Charging Using the Communication Cable	2-2
Booting the Terminal.....	2-3
Using Touch Panel Display	2-3
Home Screen	2-4
Navigation Bar.....	2-4
Command Bar	2-4
Navigation Bar Icons.....	2-5
Set Time Zone, Time, and Date.....	2-7
Pop-Up Menus	2-8
Selecting Programs.....	2-8
File Explorer.....	2-9
Search Phone	2-10

Chapter 3 - Hardware Overview

Standard Configuration	3-1
Peripherals.....	3-1
HomeBase Device	3-1
Accessories.....	3-1
USB Communication/Charging Cables	3-1
Li-ion Battery Pack.....	3-1
Dolphin Mobile Charger	3-1
Front View.....	3-2

Back View	3-4
Left View	3-5
Right View	3-6
Memory Card Installation.....	3-6
Installing a SIM Card	3-8
Bottom Panel	3-9
I/O Connector	3-9
Using the Touch Panel	3-9
Battery Pack	3-10
Charging Options.....	3-10
Charging Time	3-10
Storing Batteries	3-10
Battery Pack Use and Disposal	3-10
Managing Battery Power	3-10
Default Critical and Low Battery Points	3-10
Checking Battery Power	3-10
Turning Terminal On/Off.....	3-11
Suspending/Resuming Terminal	3-11
Hardware Maintenance	3-11

Chapter 4 - Using the Scan Image Engine

Overview.....	4-1
Angled Imaging.....	4-1
Image Engine Specifications	4-1
Laser Specifications	4-1
Supported Bar Code Symbolologies	4-2
Decoding	4-2
Decode a Bar Code	4-2
Aiming Options	4-3

Chapter 5 - Using the Camera

Overview.....	5-1
Taking a picture	5-1
Pictures & Video Menu	5-1
Options	5-2
Recording Video	5-2

Chapter 6 - Using the Keypad

29-Key Numeric Keypad.....	6-1
Using the Function Keys.....	6-1
Using the Navigation Keys	6-2
Keypad Combinations	6-2

Chapter 7 - System Settings

Overview.....	7-1
Settings Menu.....	7-1

Clock & Alarms	7-2
Personal Menu	7-3
Using File Explorer	7-4
Using ActiveSync on the Workstation.....	7-5
System Menu.....	7-6
About	7-7
Backlight	7-7
Backlight Intensity.....	7-9
Certificates.....	7-9
Encryption.....	7-10
Error Reporting.....	7-10
External GPS.....	7-11
Managed Programs	7-11
Memory.....	7-11
Main Tab.....	7-12
Storage Card	7-12
Power	7-13
Battery	7-13
Advanced Tab.....	7-13
Regional Settings	7-14
Remove Programs.....	7-14
Screen	7-15
General Tab.....	7-15
ClearType Tab.....	7-16
Text Size Tab.....	7-16
Task Manager.....	7-17
Using the Task Manager.....	7-17
A-GPS	7-18
Version	7-18
Network Time	7-18
Schedule Power On/Off.....	7-18
HAC Mode	7-18

Chapter 8 - Communication

Connections Menu.....	8-1
Connections Manager	8-2
Tasks Tab.....	8-2
Advanced Tab.....	8-3
Online Help.....	8-3
Dolphin Wireless Manager	8-3
Dolphin Wireless Manager Window.....	8-3
Enabling the Radios.....	8-4
Accessing Radio Configuration Utilities	8-4

Connecting and Synchronizing the Terminal and Workstation.....	8-4
Capabilities	8-4
Communication Types.....	8-5
Software Requirements for Communication.....	8-5
Setting Up the Host Workstation.....	8-5
Connecting the Dolphin Terminal to the Workstation	8-5
Synchronizing with the Host Workstation	8-5
Exploring the Terminal from the Workstation.....	8-5
Installing Additional Software.....	8-5
Adding Programs to the Terminal Using ActiveSync or Windows Mobile Device Center	8-6
Installer File	8-6
Non-Installer File.....	8-6
Adding Programs Directly from the Internet	8-6
COM Port Assignment Table	8-7

Chapter 9 - Working with GSM/GPRS/EDGE

Overview.....	9-1
Requirements	9-1
Voice and Data Communication	9-1
SIM Card Installation	9-1
SIM Card Requirements	9-2
Installing a SIM Card	9-2
Enabling the GSM Radio	9-3
Voice Communication.....	9-3
Audio Modes.....	9-3
Volume Control.....	9-3
Accessing the Dialer Window	9-4
Dialing.....	9-4
Sending Calls.....	9-4
Ending Calls.....	9-5
Accessing Voice Mail.....	9-5
View Options	9-5
Setup Options.....	9-5
Sounds.....	9-6
Services	9-6
Network.....	9-7
Security.....	9-7
Data Communication	9-7
System Requirements	9-7
Information Requirements	9-8
Establishing Data Communication.....	9-8
Ending the Data Connection.....	9-11
Manual Network Selection.....	9-11

Chapter 10 - Working with Bluetooth Radio

Transferring Files.....	10-4
-------------------------	------

Chapter 11 - Working with GPS

Overview.....	11-1
Assisted GPS Support.....	11-1
Communication Ports	11-1
Selecting the Port	11-1
Baud Rate.....	11-1
GPS Intermediate Driver	11-1

Chapter 12 - Dolphin 6000 HomeBase

Overview.....	12-1
Capacity.....	12-1
Charge Time.....	12-1
Charging Process	12-1
Communications.....	12-1
Parts and Functions.....	12-2
Front Panel	12-2
Terminal Well.....	12-2
AUX Battery Status LED.....	12-2
Back Panel.....	12-3
Auxiliary Battery Well.....	12-3
USB Port.....	12-3
RS232 Port	12-3
DC Power Jack.....	12-3
Power	12-3
Serial Connector.....	12-3
Charging the Battery.....	12-4
To Power a Terminal and Charge its Battery	12-4
Charging a Battery in the Auxiliary Battery Well.....	12-5
Communication.....	12-5
USB	12-5
RS232.....	12-5
Requirements	12-5
Connecting the Communication Cables	12-6
Establishing Communication	12-6

Chapter 13 - Customer Support



Agency Information

The Dolphin 6000 mobile terminal meets or exceeds the requirements of all applicable standards organizations for safe operation. However, as with any electrical equipment, the best way to ensure safe operation is to operate them according to the agency guidelines that follow. Read the following guidelines carefully before using your Dolphin 6000 terminal.

Label Locations

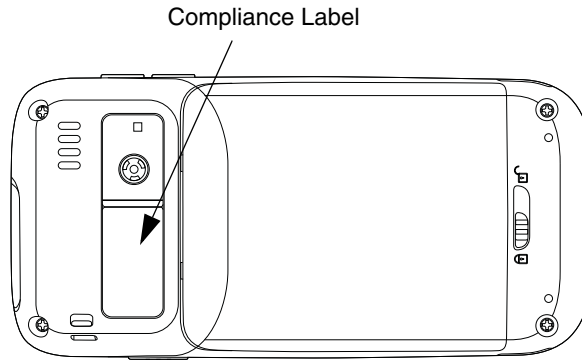

Laser Safety Label

If the following label shown below is attached to your product, it indicates the product contains a laser engine:



Laser Safety Statement

This device has been tested in accordance with and complies with IEC60825-1(Ed. 2.0), EN60825-1:2007. Complies with 21 CFR 1040.10 and 1040.11, except for deviations pursuant to Laser Notice No. 50, dated June 24, 2007. **LASER LIGHT, DO NOT STARE INTO BEAM. CLASS 2 LASER PRODUCT, 1.0 mW MAX OUTPUT: 650nm.**



WARNING - use of controls or adjustments or performance of procedures other than those specified herein may result in hazardous radiation exposure.

Europe

R&TTE Compliance Statement—802.11a/b/g, Bluetooth, and/or GSM

Dolphin RF terminals are in conformity with all essential requirements of the R&TTE Directive (1999/5/EC).

This product is marked with **CE 0560** in accordance with the Class II product requirements specified in the R&TTE Directive. In addition, this product complies to 2006/95/EC Low Voltage Directive when supplied with the recommended power supply. Honeywell shall not be liable for use of our product with equipment (i.e., power supplies, personal computers, etc.) that is not CE marked and does not comply with the Low Voltage Directive.

The equipment is intended for use throughout the European Community; PAN European Frequency Range: 2.402–2.480 GHz. Restrictions for use in France are as follows:

Indoor use: Maximum power (EIRP*) of 100 mW for the entire 2.400–2.4835 GHz.

Outdoor use: Maximum power (EIRP*) of 100 mW for the 2.400–2.454 GHz band & maximum power (EIRP*) of 10 mW for the 2.454–2.483 GHz band.

5GHz band: UNII (Unlicensed National Information Infrastructure) or band1 (5.150 to 5.250 GHz) is restricted to indoor use only. Any other use will make the operation of the device illegal.

For further information, please contact:

Honeywell Imaging & Mobility Europe BV
Nijverheidsweg 9
5627 BT Eindhoven
The Netherlands

LED Safety Statement

LEDs have been tested and classified as "EXEMPT RISK GROUP" to the standard: IEC 62471.

UL and C-UL Statement

UL and C-UL listed: UL60950-1 2nd edition and CSA C22.2 No. 60950-1 2nd edition.

CB Safety Statement

IEC 60950-1:2005 2nd edition

FCC

This device complies with Part 15 of the FCC Rules. Operation is subject to the following two conditions: (1) this device may not cause harmful interference, and (2) this device must accept any interference received, including interference that may cause undesired operation.

This equipment has been tested and found to comply with the limits for a Class B digital device pursuant to Part 15 of the FCC Rules. These limits are designed to provide reasonable protection against harmful interference in a residential installation. This equipment generates, uses, and can radiate radio frequency energy and, if not installed and used in accordance with the instructions, may cause harmful interference to radio communications. However, there is no guarantee that interference will not occur in a particular installation. If this equipment does cause harmful interference to radio or television reception, which can be determined by turning the equipment off and on, the user is encouraged to try to correct the interference by one or more of the following measures:

Reorient or relocate the receiving antenna.

Increase the separation between the equipment and receiver.

Connect the equipment into an outlet on a circuit different from that to which the receiver is connected.

Consult the dealer or an experienced radio/TV technician for help.

If necessary, the user should consult the dealer or an experienced radio/television technician for additional suggestions. The user may find the following booklet helpful: "Something About Interference." This is available at FCC local regional offices. Our company is not responsible for any radio or television interference caused by unauthorized modifications of this equipment or the substitution or attachment of connecting cables and equipment other than those specified by our company. The correction is the responsibility of the user. Use only shielded data cables with this system.

In accordance with FCC 15.21, changes or modifications not expressly approved by the party responsible for compliance could void the user's authority to operate the equipment.

CAUTION! - Any changes or modifications not expressly approved by the grantee of this device could void the user's authority to operate the equipment.

FCC: IEEE 802.11b or 802.11g operation of this product in the U.S.A. is firmware-limited to channels 1 through 11.

Industry Canada (ICES-003)

This Class B digital apparatus complies with Canadian ICES-003. Operation is subject to the following two conditions: (1) this device may not cause harmful interference, and (2) this device must accept any interference received, including interference that may cause undesired operation.

To prevent radio interference to the licensed service, this device is intended to be operated indoors and away from windows to provide maximum shielding. Equipment (or its transmit antenna) installed outdoors is subject to licensing.

Cet appareil numérique de la Classe B est conforme à la norme NMB-003 du Canada.

RF Exposure Information (SAR)

This mobile phone meets the government's requirements for exposure to radio waves. This phone is designed and manufactured not to exceed the emission limits for exposure to radio frequency (RF) energy set by the Federal Communications Commission of the U.S. Government.

The exposure standard for wireless mobile phones employs a unit of measurement known as the Specific Absorption Rate, or SAR. The SAR limit set by the FCC is 1.6W/kg and for Europe is 2W/Kg. Tests for SAR are conducted using standard operating positions accepted by the FCC with the phone transmitting at its highest certified power level in all tested frequency bands. Although the SAR is determined at the highest certified power level, the actual SAR level of the phone while operating can be well below the maximum value. This is because the phone is designed to operate at multiple power levels so as to use only the power required to reach the network. In general, the closer you are to a wireless base station antenna, the lower the power output.

The highest reported SAR values for this FCC ID are Part 22 Head 0.43 W/kg, Body-worn 0.603 W/kg; Part 24 Head 0.49 W/kg, Body-worn 0.568 W/kg; and Part 15 Head 0.086 W/kg, Body-worn 0.061 W/kg.

The highest reported CE SAR for this product is: 900 band: 0.468 W/kg, 1800 Band: 0.433W/kg and WLAN:0.046W/kg.

While there may be differences between the SAR levels of various phones and at various positions, they all meet the government requirement.

The FCC has granted an Equipment Authorization for this model phone with all reported SAR levels evaluated as in compliance with the FCC RF exposure guidelines. SAR information on this model phone is on file with the FCC and can be found under the Display Grant section of www.fcc.gov/oet/ea/fccid after searching on FCC ID: HD56000.

For body worn operation, this phone has been tested and meets the FCC RF exposure guidelines for use with an accessory that contains no metal and the positions the handset a minimum of 1.5 cm from the body. Use of other accessories may not ensure compliance with FCC RF exposure guidelines. If you do not use a body-worn accessory and are not holding the phone at the ear, position the handset a minimum of 1.5 cm from your body when the phone is switched on.

For European Community Users

Honeywell complies with Directive 2002/96/EC OF THE EUROPEAN PARLIAMENT AND OF THE COUNCIL of 27 January 2003 on waste electrical and electronic equipment (WEEE), European REACH Regulation 1907/2006 of 1 June, 2007, and Restriction of Hazardous Substances Directive (RoHS)2002/95/EC of 1 July 2006.

Waste Electrical and Electronic Equipment Information

This product has required the extraction and use of natural resources for its production. It may contain hazardous substances that could impact health and the environment, if not properly disposed.

In order to avoid the dissemination of those substances in our environment and to diminish the pressure on the natural resources, we encourage you to use the appropriate take-back systems for product disposal. Those systems will reuse or recycle most of the materials of the product you are disposing in a sound way.

 The crossed out wheeled bin symbol informs you that the product should not be disposed of along with municipal waste and invites you to use the appropriate separate take-back systems for product disposal. If you need more information on the collection, reuse, and recycling systems, please contact your local or regional waste administration. You may also contact your supplier for more information on the environmental performances of this product.

Pacemakers, Hearing Aids and Other Electrically Powered Devices

Most manufacturers of medical devices adhere to the IEC 601-1-2 standard. This standard requires devices to operate properly in an EM Field with a strength of 3V/m over a frequency range of 26 to 1000MHz. The maximum allowable field strength emitted by the Dolphin terminal is 0.3V/m according to Subpart B of Part 1 of the FCC rules. Therefore, the RF from the Dolphin terminal has no effect on medical devices that meet the IEC specification.

Microwaves

The radio in the Dolphin RF terminal operates on the same frequency band as a microwave oven. Therefore, if you use a microwave within range of the Dolphin RF terminal you may notice performance degradation in your wireless network. However, both your microwave and your wireless network will continue to function.

China RoHS

 有毒有害物质名称及含量的标识格式 (Names and Content of Hazardous Substances or Elements)						
部件名称 (Parts Name)	有毒有害物质或元素 (Toxic and Hazardous Substances or Elements)					
	铅 (Pb)	汞 (Hg)	镉 (Cd)	六价铬 (Cr6+)	多溴联苯 (PBB)	多溴二苯醚 (PBDE)
IS4813	x	0	0	0	0	0
印刷电路板 (PCB)	x	0	0	0	0	0
外壳 (Housing)	0	0	0	0	0	0
连线 (Cables)	x	0	0	0	0	0
液晶显示器 (LCD)	x	0	0	0	0	0
电池 (Battery)	0	0	0	0	0	0
键盘 (Keypad)	0	0	0	0	0	0

o: 表示该有毒有害物质在该部件所有均质材料中的含量均在 SJ/T11363-2006 标准规定的限量要求以下 (Indicates that this toxic or hazardous substance contained in all of the homogeneous materials for this part is below the limit requirement in China's SJ/T11363-2006.)
 x: 表示该有毒有害物质至少在该部件的某一均质材料中的含量超出 SJ/T11363-2006 标准规定的限量要求 (Indicates that this toxic or hazardous substance contained in at least one of the homogeneous materials for this part is above the limit requirement in China's SJ/T11363-2006.)

Operating Temperature

The recommended operating temperature for the terminal is -10°C to 50°C (14°F to 122°F).

Approvals by Country

Country	EMC, Radio, & SAR	Safety
U.S.A.	FCC Part 15, Subpart B Class B FCC Part 15, Subpart C, 15.247 FCC Part 15, Subpart E FCC Part 22H FCC Part 24E FCC SAR OET 65 Supplement C FCC 20.19	UL60950-1
Canada	ICES-003 (Class B) RSS 102, RSS-132, RSS-133, RSS-210	CSA C22.2 No. 60950-1-07
European Community/CE	EN300328, EN301893, EN55022, EN55024, EN301489-1, EN301489-7/24, EN301489-17, EN300328, 3GPPTS 51.010-1, EN301511, EN301908, EN50360, EN50361, EN50371, EN50392, IEC6220-1, IEC6220-2, EN62311, EN300440	EN/IEC60950-1 EN/IEC60825-1
China	SRRC, MII	CCC
Brazil	Anatel	
Mexico	COFETEL	NOM-019-SCFI-1998
Australia/New Zealand	A Tick (GSM), CTick (WLAN, BT)	

Getting Started

Out of the Box

Verify that the carton contains the following items:

- Dolphin 6000 mobile terminal
- Battery pack (3.7V Li-ion)
- Quick Start Guide

Note: If you ordered accessories for your terminal, verify that they are included with the order.

Be sure to keep the original packaging in case you need to return the terminal for service. For details, see [Customer Support](#) on page 13-1.

Installing Battery Pack



Ensure all components are dry prior to placing the battery in the terminal. Mating wet components may cause damage not covered by the warranty.

The Dolphin 6000 device is shipped with the battery packaged separately from the terminal. Perform the following to install the battery:

1. Slide the latch to unlock the battery door.
2. Open the battery door.
3. Install the battery into the battery well.

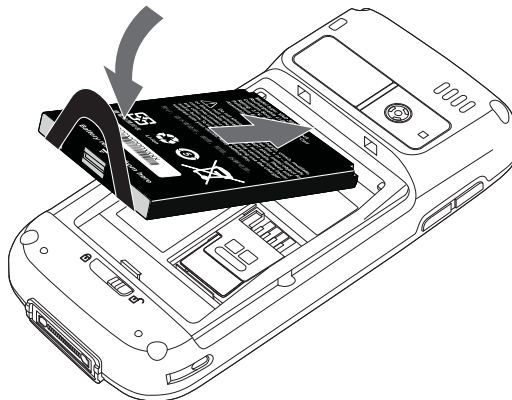

4. Install the battery door.

Note: Install the battery door before powering on the terminal.



We recommend use of Honeywell peripherals, power cables, and power adapters. Use of any non-Honeywell peripherals, cables, or power adapters may cause damage not covered by the warranty.

Removing Battery Pack

Perform the following to remove the battery:

1. Slide the latch to unlock the battery door.
2. Open the battery door.

3. Remove the battery by lifting the tab.

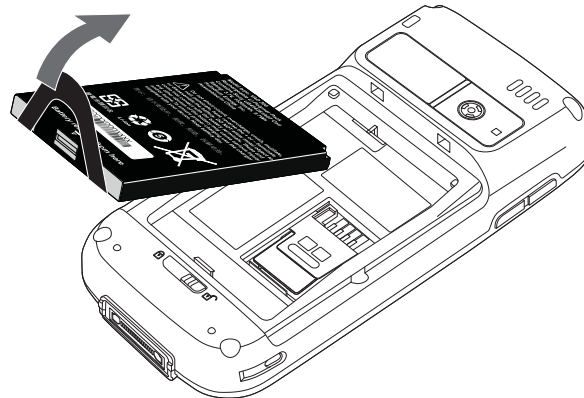

Note: Gentle force is required to lift and remove the battery from the battery bay.

Charging the Batteries

Power for the Dolphin 6000 terminal comes from the battery pack, which is accessed from the back panel.

Before Initial Use

The terminals are shipped with the battery discharged of all power. The initial charging time for the battery pack is 4 hours. Insert the terminal into the HomeBase or connect to the Communication Cable to charge the battery.



We recommend use of Honeywell peripherals, power cables, and power adapters. Use of any non-Honeywell peripherals, cables, or power adapters may cause damage not covered by the warranty.

Charging Using the Communication Cable

Note: The battery may be charged (via HomeBase, USB Communication cable) as long as the temperature is between 0-40°C (32-104° F). If the ambient temperature is less than 0° or greater than 40°C, the device runs off of battery power even if external power is applied.

1. Slide the terminal into the cup on the USB communication cable to mate with the I/O connector.
2. Plug the power adapter cable into the power connector on the USB Communication cable.
3. Plug the USB Communication cable into the appropriate port on the host terminal.

-
4. Plug the power adapter into a standard wall outlet. The LED on front of the terminal flashes and illuminates red when the terminal begins the initializing boot process.

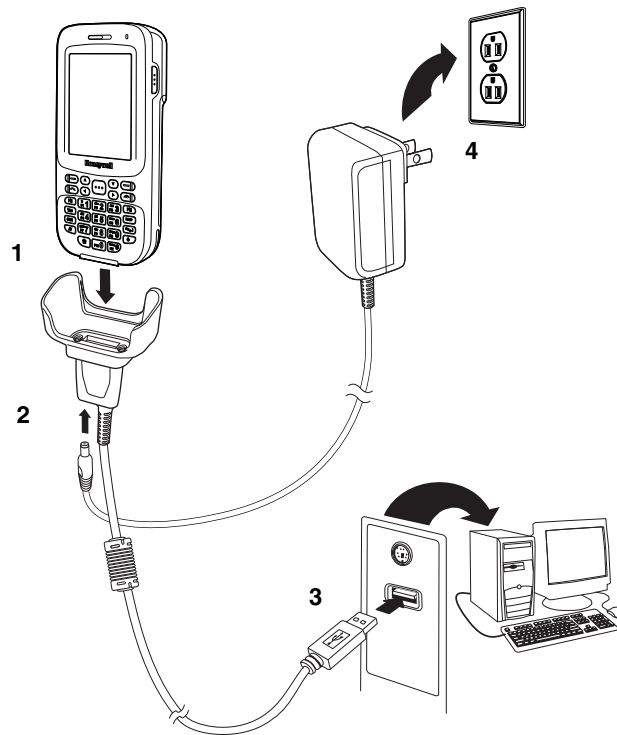

Booting the Terminal

The terminal boots when power is applied and the PWR button is pressed for three seconds.

Caution: Do not press any keys or interrupt the boot process. When the boot process is complete, the Home screen appears and the terminal is ready for use.

Note: The Home screen appears and the CAB files install. The Home screen appears a second time. Wait several seconds before using the terminal to make sure that the boot process is complete.

Using Touch Panel Display

The touch panel display is activated by using a stylus (included with the terminal) or your finger. To activate the display, open a file or select a menu, use the tip of the stylus to tap the touch panel display or gently press the touch panel with your finger.

Home Screen

After the terminal initializes the first time, the Home screen appears.

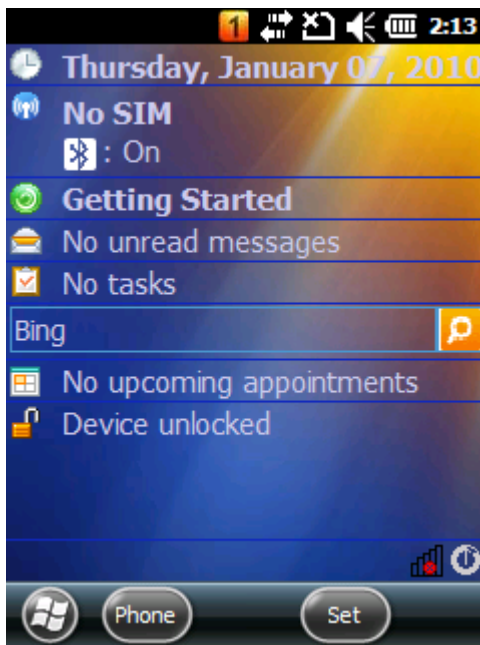

Navigation Bar

The Navigation bar is located at the top of the screen. The active program and current time are shown.





































Command Bar



The Command bar is located at the bottom of the screen.



Navigation Bar Icons

Indicator	Meaning
	Synchronizing data
	The terminal could not synchronize data with the workstation via ActiveSync.
	New e-mail
	New text message
	New voicemail
	New instant message
	Vibrate on
	Ringer off
	Speakerphone on
	Voice call in progress
	Calls are forwarded
	Call on hold
	Missed call
	Data call in progress
	Battery has a full charge.
	Battery has a high charge.
	Battery has a medium charge.

Indicator	Meaning
	Battery has a low charge.
	Battery has a very low charge and requires charging.
	The terminal is running on external power. If a battery pack is installed, battery is charging in the background.
	The terminal is not connected to external power. A battery is installed, but is defective; its charge level cannot be measured.
	No SIM card is installed
	GPRS available
	GPRS connecting
	GPRS in use
	EDGE available
	EDGE connecting
	EDGE in use
	Radio is off
	The radio is not connected to a network.
	The radio is connected. The bars indicate signal strength.
	No radio signal
	The terminal is searching for a signal.
	Wi-Fi is on, but terminal is not connected.

Indicator	Meaning
	Wi-Fi data call
	Pending alarm
	Bluetooth

Set Time Zone, Time, and Date

1. On the Home screen, tap the time and date section.

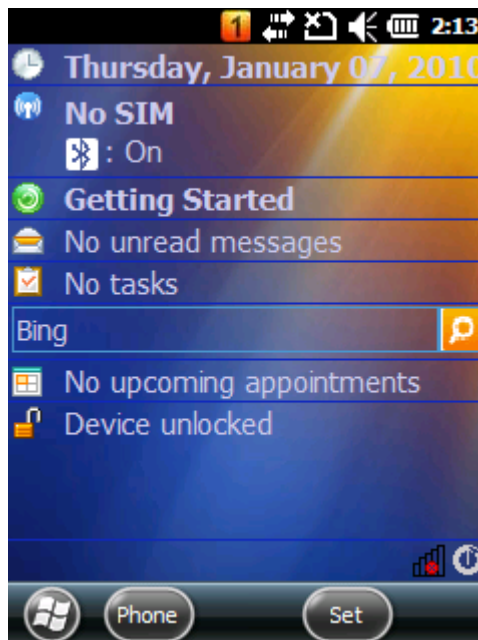

The Clock & Alarms menu opens.

2. Select the **Time** tab to set the system clock.

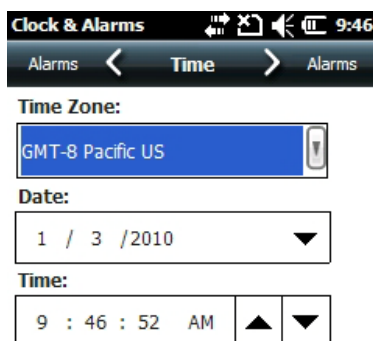

3. Tap the Time Zone box to open a drop-down menu.

-
4. Set the correct time zone from the drop-down menu.
 5. Set the correct time and date in the remaining fields and tap **OK** to save the settings.

Pop-Up Menus

Pop-up menus allow you to choose an action for a selected file.

1. Tap and hold the stylus on the action to open the pop-up menu.
2. When the menu appears, lift the stylus, and tap the action desired.

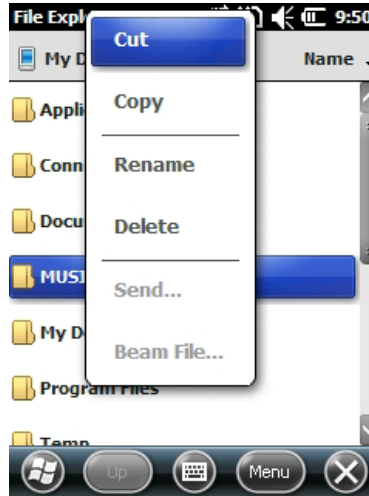

3. Tap outside of the pop-up menu to close it without performing an action.

Selecting Programs

1. Tap  to access the Start Menu.
2. Open the desired program by tapping on the program icon.
3. Move an icon to the top of the Start Menu by tapping, then holding the stylus on the icon, while dragging the icon to the top of the Start Menu.

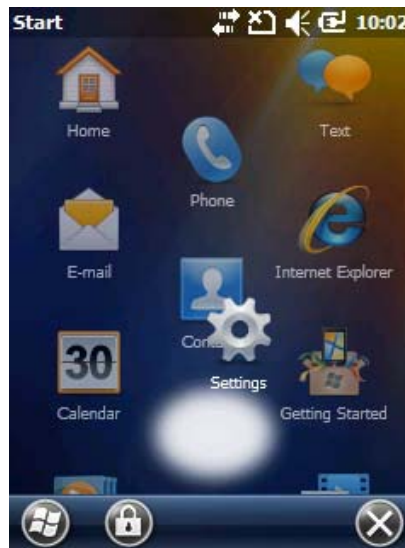

File Explorer

Use the File Explorer to find and move files.

1. Tap  > **File Explorer**.
2. Locate a file.

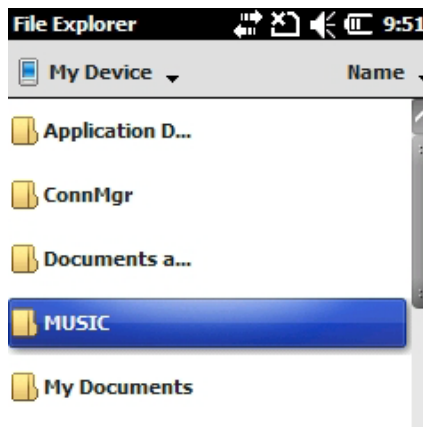

3. To move a file, hold the stylus on the file to bring up the menu shown below. Tap **Cut** or **Copy** on the pop-up menu.

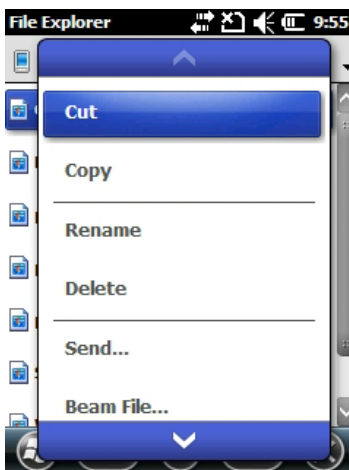

4. Navigate to the desired destination.
5. Hold the stylus in the blank area of the window.
Note: If there is no blank area in the window, go to step 7.
6. Tap **Paste** on the pop-up menu.

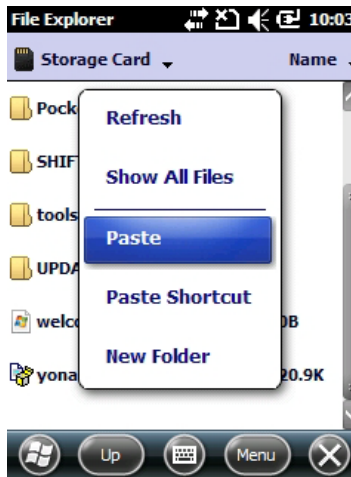

7. Tap Menu on the Command bar. A pop-up menu appears.

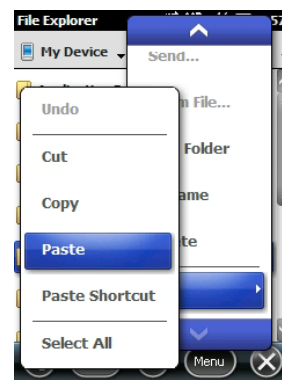
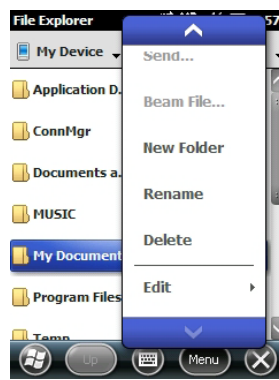
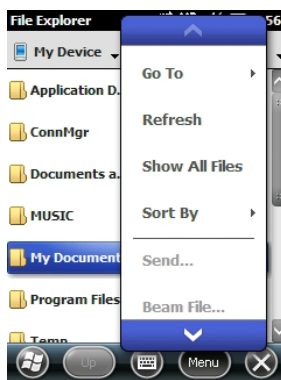

8. Tap the down arrow on the pop-up menu to view the Edit option.

9. Tap **Edit > Paste**.

Search Phone

Use the Search Phone application to quickly find information.

1. Tap  > **Search Phone**.
2. To find a file, type the name of file in the Search For box.
3. Select the type of data in the Type box
4. Tap **Search** on the Command bar.
5. Select **Larger than 64 KB** in the Type box drop-down menu to find large files.

Hardware Overview

Standard Configuration

The following is a list of configuration features:

- Microsoft® Windows Mobile® 6.5 Professional
- MTK MT6516 ARM9 416MHz Processor
- 256MB SDRAM X 512MB Flash
- 29-Key Numeric Keypad
- 3.7V Li-ion rechargeable battery pack
- IS4813 laser scan engine
- 802.11b/g, Bluetooth, and GSM/GPRS/EDGE
- GPS
- 3 megapixel auto focus, color camera

Peripherals

HomeBase Device

The Dolphin 6000 HomeBase provides charging and communication functionality supporting both RS232 and USB communications, which enables the terminal to interact with the majority of PC-based enterprise systems. The terminal also contains an auxiliary battery well that can charge a spare Li-ion battery.

The following is a list of the HomeBase features:

- RS232 (RX, TX, CTS, RTS), D-sub connector
- USB Client, Mini USB connector
- DC-IN
- Separate battery charger.

Note: The USB Communication Cable must be no more than 125 cm (4.1 ft) to guarantee transmission quality.

For more information, refer to [Dolphin 6000 HomeBase](#) on page 12-1.

Accessories

USB Communication/Charging Cables

The Dolphin 6000 communication/charging cable kit is an all-in-one solution for mobile applications. The cable kit performs the following:

- Powers the terminal
- Charges the terminal's battery
- Communicates with host via USB without a HomeBase
- Functions with the power adaptor included in the cable kit. Refer to [Approvals by Country](#) on page 1-4 table for available AC adaptor types.

Li-ion Battery Pack

The 3.7V Li-ion rechargeable battery pack provides the power for the terminal.

Dolphin Mobile Charger

The Dolphin 6000 Mobile Charger is an optional accessory. The Dolphin Mobile Charger is a charging cable that connects the terminal directly to a 12 Volt DC power source, such as a cigarette lighter port inside a vehicle, eliminating the need for a cradle. The cable powers the terminal and charges the battery in four hours. Intelligent battery technology on-board the terminal ensures proper charging. The Dolphin Mobile Charger is an ideal low-cost charging solution for in-transit mobile applications.

Front View

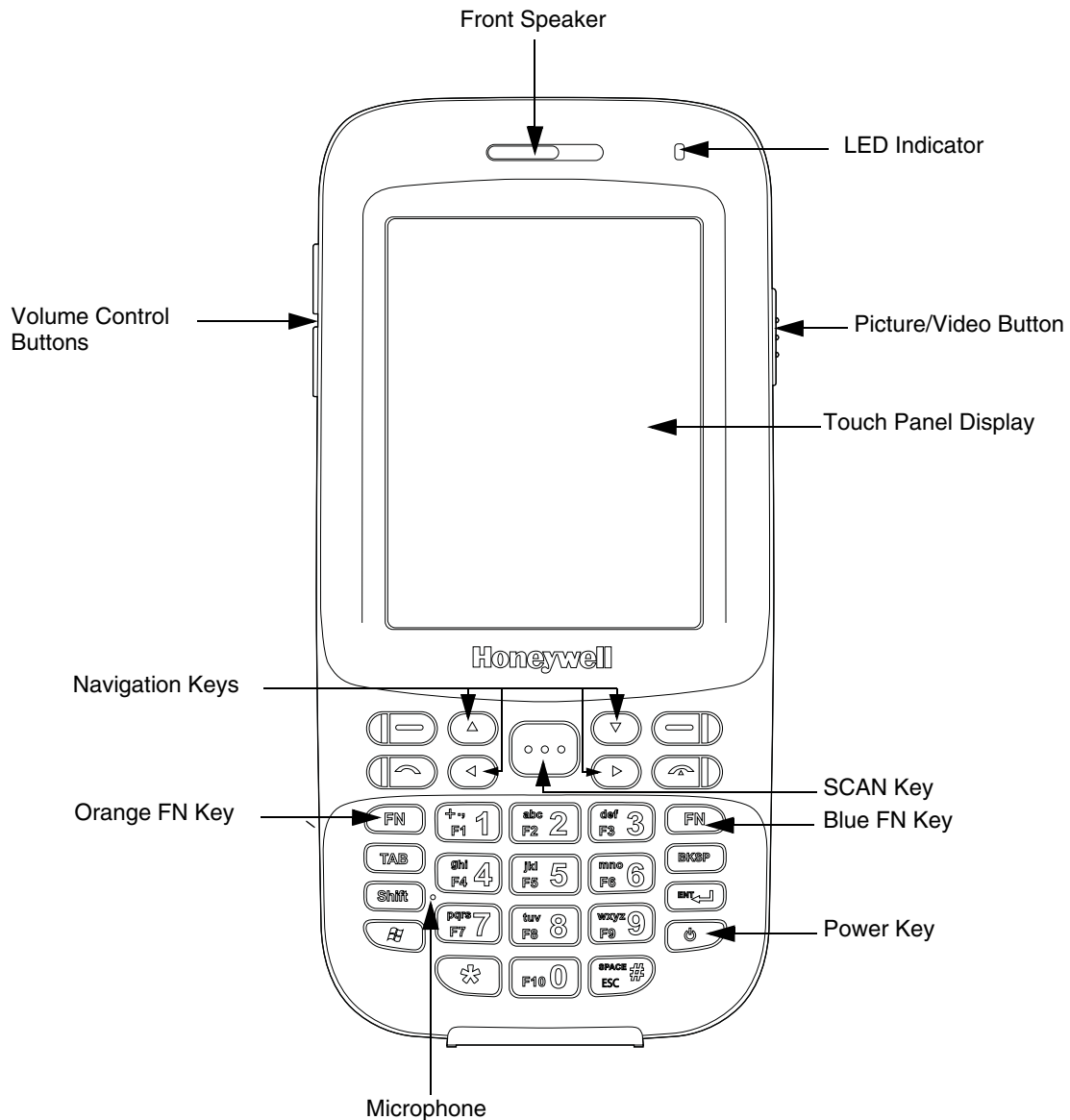

Item	Description
Front Speaker	Receives voice calls when using a handset. Refer to Voice Communication on page 9-3.
Indicator Light Emitting Diode (LED)	Flashes and illuminates during resets and scanning/imaging. Can be programmed by various software applications.
Touch Panel Display	A color 2.8 inch liquid crystal display (LCD) touch panel is covered with an industrial, protective lens The video graphic array (QVGA) display resolution of 240 X 320.

Item	Description
SCAN Key	Activates the scanner.
Blue FN Key	Switches the numeric keypad to an alpha/numeric mode or to F1-F10 function keys mode.
Power Key	Pressing and holding the Power key for 3 seconds turns the terminal on. Pressing and holding the Power key for 5 seconds turns the terminal off. Pressing and releasing the Power key puts the terminal in the Suspend Mode or wakes the terminal from the Suspend Mode. Refer to Suspending/Resuming Terminal on page 3-11.
Microphone	Provides audio input for the handset and speakerphone voice calls. Refer to Voice Communication on page 9-3.
Recessed Keypad	The terminal has a 29-key alpha/numeric keypad. For more information refer to 29-Key Numeric Keypad on page 6-1.
Orange FN Key	Switches the numeric keypad from lowercase or uppercase modes.
Navigation Keys	When selected, move through the software programs. Refer to Using the Navigation Keys on page 6-2.

Back View

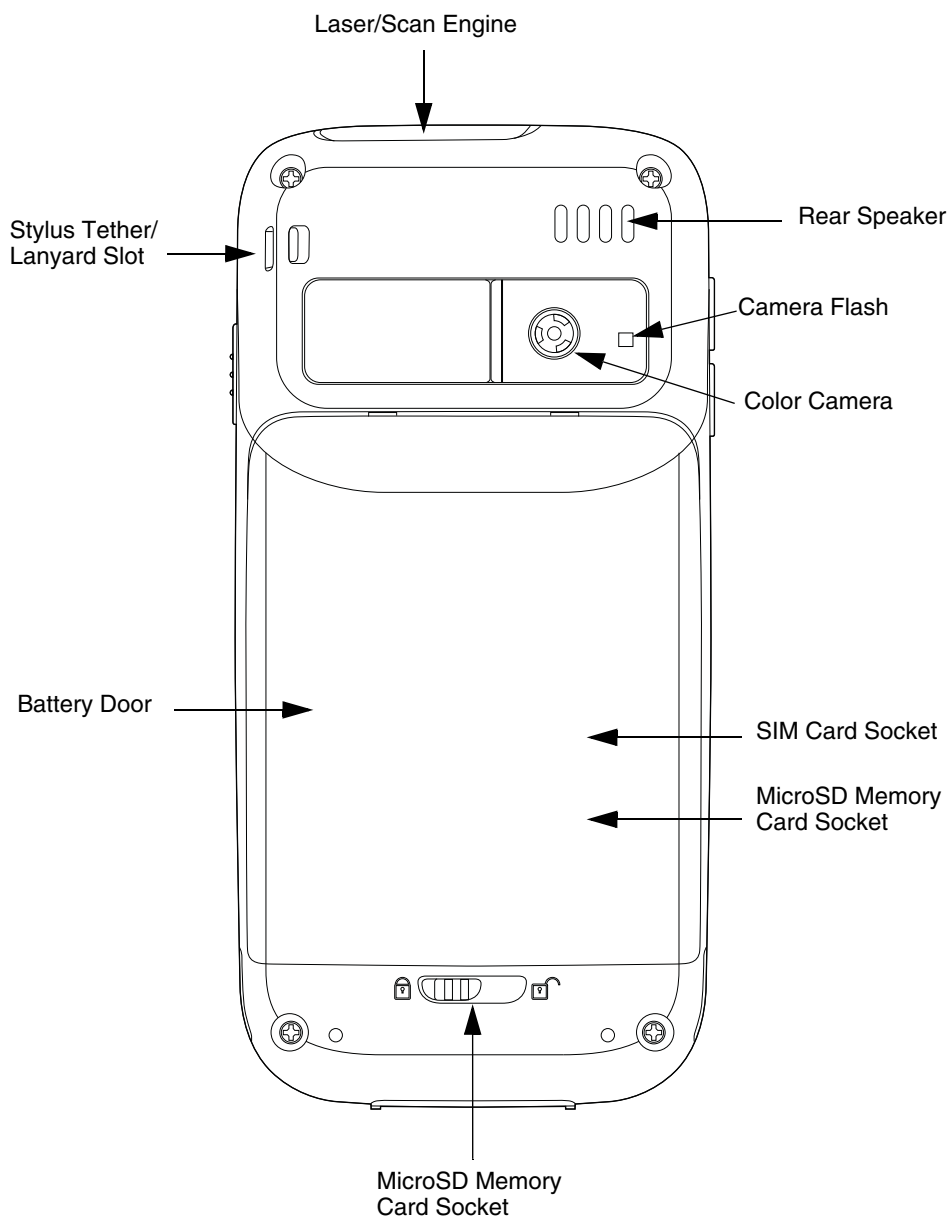

Item	Description
Image/Scan Engine Window	The image engine reads and decodes linear, stacked linear (e.g., PDF417), and 1D matrix bar code symbologies. For greater accuracy, the terminal contains a laser aimer. Refer to Using the Scan Image Engine on page 4-1 .
Rear Speaker	Provides audio signals when scanning bar code labels or entering data. Supports playback for wave and MP3 files, software mixer, and Speakerphone for WWAN/GSM audio and VoIP. The operating frequency range is 1000-4000Hz at >86 dB.

Item	Description
Color Camera	Provides easy picture caption with Automated Camera Control (ACC). Additional features include automated picture profiles and an Application Programming Interface (API).
Camera Flash	Can be used and is controlled by the terminal's color camera.
Battery Door	Secures the Li-ion Battery Pack in the terminal battery well. Refer to Battery Pack on page 3-10.
Stylus Tether/Lanyard Slot	A coiled, elastic cord that tethers the stylus to the terminal is attached in this slot.
Subscriber Identity Module (SIM) Card Socket	Connection for SIM Card use. Refer to Installing a SIM Card on page 9-2. <i>Note: SIM Card Socket is located underneath the battery door.</i>
Memory Card Socket	Provides the user with an option to expand the terminal's memory capacity. Supports industry-standard MicroSD and MicroSDHC memory interfaces. Refer to Memory Card Installation on page 3-6. <i>Note: Memory Card Socket is located underneath the battery door.</i>

Left View

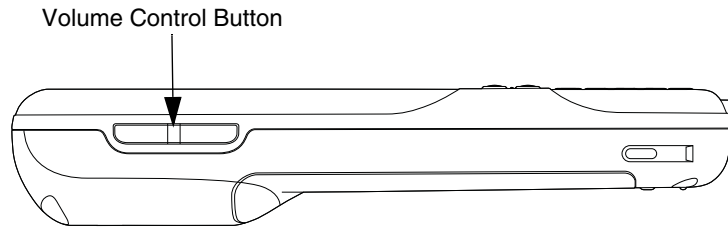

Left View

Item	Description
Volume Control Button	Used to raise or lower the terminal volume.

Right View

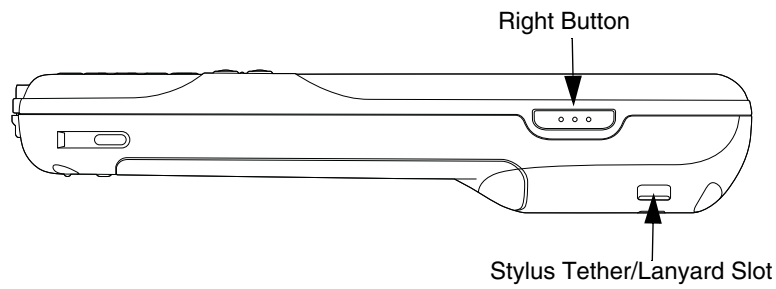

Item	Description
Right Button	Acts as an Enter key; handy when taking pictures/videos.
Stylus Tether/Lanyard Slot	Attach point for stylus tether/lanyard

Memory Card Installation

Perform the following to install the memory card:

1. Power down the terminal.
2. Unlock the battery door.
3. Remove the battery door and the battery.
4. Slide the latch toward top of terminal to unlock the SIM card.

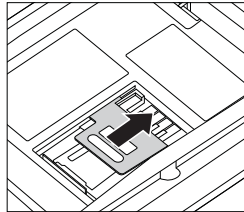

5. Lift the SIM card latch to reveal the SIM card.

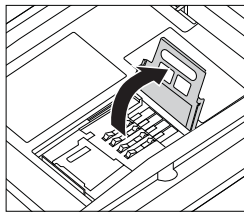

6. Remove the SIM card to reveal the memory card latch.

7. Unlock the memory card latch by sliding the latch away from serial number label located in the battery well.

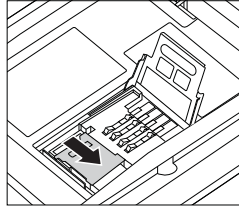

8. Lift the latch up to expose the MicroSD or MicroSDHC socket.



9. Remove and discard SD card blank and replace with SD card to be installed.

10. Insert a microSD or microSDHC card into the microSD or microSDHC socket.

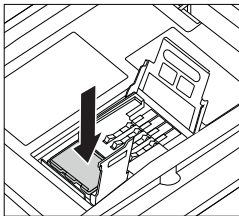

Note: Make sure the interface on the memory card is connected to the interface in the socket.

11. Close the memory card latch.

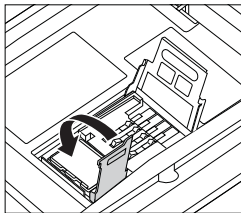

12. Lock the memory card latch by sliding the latch toward the serial number label.

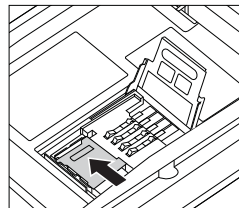

13. Insert the SIM card into the SIM card socket.

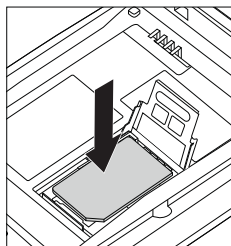

Note: Make sure the interface on the SIM card is connected to the interface in the socket. Align the chamfered corner on the card with the chamfered corner of the socket.

14. Close the SIM card latch.

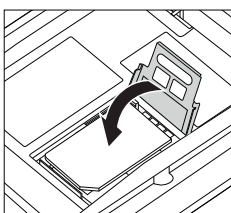

15. Lock the SIM card latch by sliding the latch towards the bottom of the terminal.

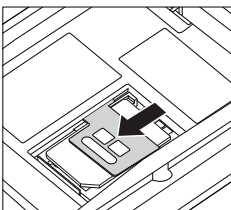

16. Install the battery.

17. Install and lock the battery door.

18. Power on the terminal.

Note: It is recommended to format all SD cards before initial use.

Installing a SIM Card

For instructions on installing a SIM card, refer to [Installing a SIM Card](#) on page 9-2.

Bottom Panel

I/O Connector

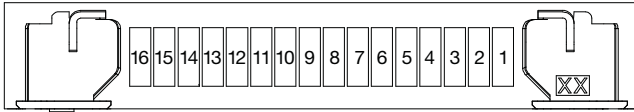

Pin	Description
1	GND
2	USB_5V_IN
3	USB_D-
4	USB_D+
5	RTS
6	UART1_RX
7	UART1_TX
8	GND
9	CTS
10	GND
11	GND
12	Cradle_Detect
13	TXD
14	RXD
15	VDC_IN
16	VDC_IN

The I/O connector provides the following:

- Supports DC charging of the terminal and battery
- Facilitates RS232 serial communications interface, including RX, TX, RTS, CTS and GND signals
- USB interface to a host workstation via HomeBase or communication cable

All Dolphin 6000 peripherals are designed to work exclusively through this connector. The I/O connector supports RS232 and USB communication. For RS232, the maximum communication speed is 115.2 Kbps with seven baud rate settings. For USB, communication speed is up to 480 Mbps.

Using the Touch Panel

Honeywell defines proper use of the terminal touch panel as using a screen protector and proper stylus. Screen protectors maintain the ongoing integrity (i.e., prevent scratching) of the touch panel, which is why their use is recommended for applications that require a high to medium level of interface with the touch panel, such as signature capture for proof of delivery.

Honeywell advocates the use of screen protectors on all Dolphin devices. We recommend implementing a screen protector replacement program to ensure that screen protectors are replaced periodically when signs of damage/wear are noticeable. Replacement screen protectors can be purchased directly from Honeywell. Please contact a Honeywell sales associate for details.

Honeywell also mandates use of a proper stylus, which is one that has a stylus tip radius of no less than 0.8 mm. Use of the Honeywell stylus included with the terminal is recommended at all times.

Honeywell warranty policy covers wear on the touch panel for the first twelve (12) months if a screen protector is applied and an approved stylus is used for the 12 month duration covered by the warranty.

Battery Pack



We recommend use of Honeywell Li-Ion battery packs. Use of any non-Honeywell battery may result in damage not covered by the warranty.

The 3.7V, 5.7W hour Li-ion battery pack is the primary power source for the terminal. The Li-ion battery is designed to operate in a temperature range of -10°C to 50°C (14°F to 122°F).

Charging Options



Ensure all components are dry prior to placing the battery in the terminal. Mating wet components may cause damage not covered by the warranty.

Note: The battery may be charged (via HomeBase, USB Communication cable) as long as the temperature is between 0-40°C (32-104°F). If the ambient temperature is less than 0° or greater than 40°C, the device runs off of battery power even if external power is applied.

If the battery is installed in the terminal, it will be charged if the terminal is in the HomeBase or if the terminal is connected to the USB Communication cable and the AC adapter is plugged in. (The terminal cannot be charged via the USB Communication cable only.) If the battery is not installed in the terminal, it may be charged by placing it in the HomeBase's battery well. Use the Dolphin 6000 HomeBase (Refer to [Dolphin 6000 HomeBase](#) on page 12-1).

Charging Time

The Li-ion battery pack requires 4 hours to charge completely before initial use.

Storing Batteries

To maintain optimal battery performance, follow these storage guidelines:

- Avoid storing batteries outside the specified range of -4° to 104° F (-20° to 40°C) or in extremely high humidity.
- For prolonged storage, do not keep batteries stored in a charger that is connected to a power source.

Battery Pack Use and Disposal

The following are guidelines for the safe use and disposal of batteries.

- We recommend use of Honeywell Li-Ion battery packs. Use of any non-Honeywell battery may pose a personal hazard to the user.
- Follow local regulations for battery disposal.
- Replace defective batteries immediately. Using a defective battery could damage the Dolphin 6000 terminal.
- Do not use a battery in any other manner outside of its intended use in the Dolphin 6000 terminal and peripherals.
- Excessive discharge damages a battery. Recharge the battery when the terminal indicates low battery power.
- Battery life is limited. Replace a battery after it is unable to hold an adequate charge.
- If you observe that the Honeywell battery supplied is physically damaged, please send it to Honeywell International Inc. or an authorized center for inspection. Refer to [Product Service and Repair](#) on page 13-1.
- If you are not sure if the battery or charger is working properly, send it to Honeywell International Inc. or an authorized service center for inspection. Refer to [Product Service and Repair](#) on page 13-1.
- If the battery or charger are not working properly, replace it as soon as possible.

Managing Battery Power

Default Critical and Low Battery Points

When the terminal is running on battery power (as opposed to external power), warnings are displayed when the battery reaches critical and low battery points.

Checking Battery Power

To check the battery power:

-
1. Navigate to the Power Menu by selecting  > **Settings** > **System** > **Power**.

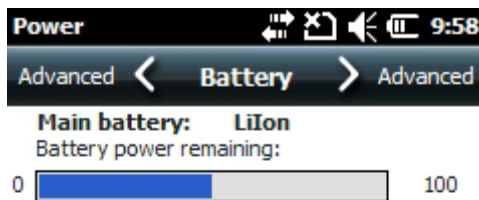

Turning Terminal On/Off

To turn the Dolphin 6000 terminal on:

1. Press and hold the **Power** button for 3 seconds.

Note: Turning the terminal off is the equivalent to a hard boot.

To turn the Dolphin 6000 terminal off:

1. Press and hold the **Power** button for 5 seconds.
2. Tap **OK** to shutdown.

Suspending/Resuming Terminal

To put the device into Suspend mode when the terminal is powered on:

1. Press and release the power button.
2. To resume from the Suspend mode, press and release the **Power** button.

The terminal goes into the Suspend Mode automatically when it is inactive for a period of time. To set a time interval, select  > **Settings** > **Power** > **Advanced**. Refer to [Power](#) on page 7-13.

Hardware Maintenance

When needed, clean the image engine window and the touch screen with a clean, non-abrasive, lint-free cloth. The terminal can be cleaned with a damp cloth.



Using the Scan Image Engine

Overview

The bar code engine in the Dolphin 6000 terminal is the Honeywell IS4813.

Angled Imaging

The scan engine view of field is 54 degrees.

Image Engine Specifications

Depth of Field vs. Minimum Bar Code Element

Bar Code Element Width			Depth of Field* (In the Field of View)		
			Start (Frm Engine Face)	End (Frm Engine Face)	Total
1D	.13 mm	5.2 mil	70 mm (2.75")	95 mm (3.75")	25 mm (1.00")
	.19 mm	7.5 mil	57 mm (2.25")	171 mm (6.75")	114 mm (4.50")
	.26 mm	10.4 mil	50 mm (2.00")	210 mm (8.25")	160 mm (6.25")
	.33 mm	13.0 mil	50 mm (2.00")	254 mm (10.00")	204 mm (8.00")
	.49 mm	19.5 mil	75 mm (2.95")	300 mm (11.81")	225 mm (8.86")
<p>* For non-decode IS4813 and IS4815 engines, depth of field data is for reference only. Actual values may vary depending on environmental conditions, host hardware, and decoding software.</p> <p>Depth of field data was measured at 25°C under typical indoor lighting. Performance may vary depending on testing conditions.</p>					

Laser Specifications

The maximum power output for each diode is:

- Illumination LED: 194.0 uW

Supported Bar Code Symbologies

Symbology Type	Symbology Name
1D Symbology	Codabar Code 3 of 9 Code 11 Code 32 Pharmaceutical (PARAF) Code 93 Code 128 EAN with Add-On EAN with Extended Coupon Code EAN-8 EAN-13 GS1-128 GS1 Databar Interleaved 2 of 5 ISBT 128 Matrix 2 of 5 MSI Plessey PosiCode Straight 2 of 5 IATA Straight 2 of 5 Industrial Telepen Trioptic Code UPC UPC-A UPC-E

Decoding

Decode a Bar Code

Point the aiming beam at a bar code. The aiming beam must align with bar code for better results. Holding the terminal between 4-10 inches (10-25 cm) from a bar code is recommended.

1. Tap  > **Demos** > **Scan Demo**.

Note: You may activate the Vibrate option by selecting  > **Demos** > **Scan Demo** > **Setup** > **Vibrate**. The device vibrates each time a bar code is decoded.

2. Aim the scanner at the bar code.

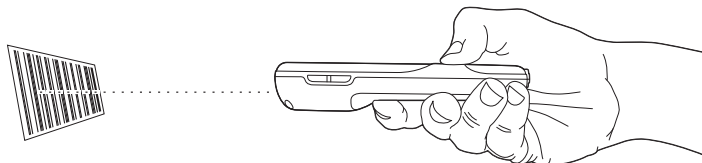

3. Project the aiming beam by pressing and holding the **SCAN** key. The LED flashes red.
4. Center the aiming beam over the bar code. For optimum performance, avoid reflections by scanning the bar code at a slight angle. To decode stacked bar codes (e.g., PDF417), slowly move the beam up or down over the code.
5. When the bar code is successfully decoded, the terminal LED flashes green and the terminal beeps. The bar code information is entered into the application in use.

Aiming Options

The aiming beam is narrower when you hold the terminal closer to a bar code and the aiming beam is wider when you hold it farther from a bar code.

The aiming beam must be aimed closer to symbologies that have smaller bars or elements (mil size). The aiming beam must be aimed farther from symbologies that have larger bars or elements (mil size).





Using the Camera

Overview

The Dolphin 6000 terminal contains a 3.0-megapixel color camera, Automated Camera Control (ACC) and an Application Programming Interface (API). The API provides easy access to color picture and video capture functions. The camera lens and camera flash are located on the back of the terminal.

Taking a picture

1. Tap  > **Pictures & Videos** > **Camera**.
2. Point the camera lens at an object.
3. Adjust the position of the camera lens to make sure that the object is showing on the screen.
4. Press the **Picture/Video** button on the side of the terminal to take a picture.

Pictures & Video Menu

Tapping the **Menu** option on the Command Bar allows you to change camera settings, switch to video mode, or to see more camera options.

Item	Descriptions
Video	Start Video Mode
Mode	Normal Mode, Burst Mode, Timer Mode
Brightness	Set the brightness setting from +3.0 EV to -3.0 EV in .5 EV increments
Resolution	Set picture resolution (i.e., 320 x 240, 640 x 480, 1280x960, 2048x1536)
Zoom	Set zoom (x1, x2, x3, x4, x5, x6)
Focus Mode	Focus On, Focus Off, Focus on Trigger, or Fixed-Focus
Focus Trigger	When focus mode is set to focus off, use focus trigger to focus the camera on current scene.
White Balance	Set mode to Auto, Cloudy, Sunlight, Incandescent, Fluorescent, Tungsten
Flash	Turn Camera Flash On or Camera Flash Off
Options	Set General, Slide Show, Camera, and Video options
Full Screen	Sets the screen to full screen view

Options

Tap **Menu > Options**. The Options menu contains four tabs:

General Tab

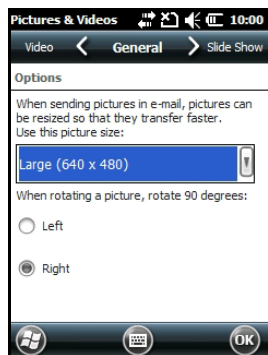

Slide Show Tab

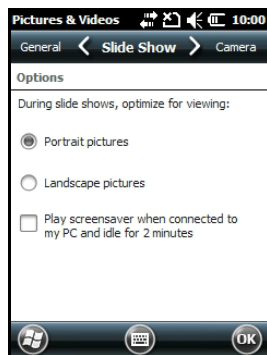

Camera Tab

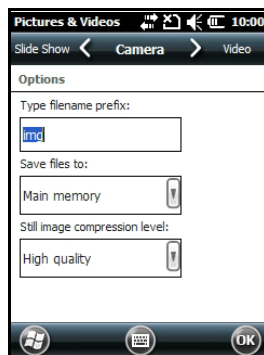

Video Tab

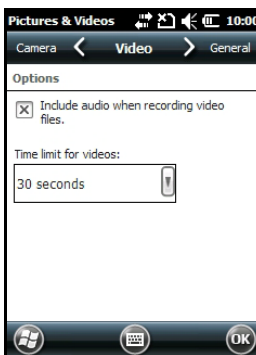

Recording Video

1. Tap  > **Pictures & Videos > Camera > Menu > Video**.
2. Point the camera lens at an object.
3. Adjust the position of the camera lens to make sure that the object is showing on the screen.
4. Press the **Picture/Video** button on the side of the terminal to start recording.
5. Tap **Stop** on the screen or press the **Picture/Video** button on the side of the terminal to stop recording.







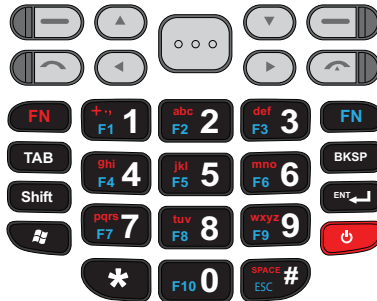

Using the Keypad









29-Key Numeric Keypad

The Dolphin 6000 terminal has a 29-key alpha/numeric keypad.



Using the Function Keys

Name	Key	Function
Backspace		Moves the cursor back one space each time the key is pressed. If typing text, it deletes the previous character each time it is pressed.
Enter (ENT)		Confirms data entry.
Escape (ESC)		Cancels the current action. Press the ESC key to return to the previous menu.
Power Key		Puts the terminal into and wakes the terminal from Suspend Mode; see Suspending/Resuming Terminal on page 3-11.
SCAN Key		Activates the scanner.
SPACE		Moves the cursor ahead one space.
Windows Key		Brings up Start screen. Pressing a second time takes you back to previous screen.
TAB		Moves the cursor to the next tab stop or next control (on a form).

Name	Key	Function
4-way Navigation Keys		Moves the cursor left, right, up or down.
Shift Key		Changes the keyboard between uppercase alphabet mode and lowercase alphabet mode.
Orange FN Key		The orange FN key has 3 operating modes for Normal (default), Uppercase and Lowercase mode. Press the orange FN key to change each mode.
Blue FN Key		The blue FN key activates the F1~F10 function keys. Press the blue key again to return to the default mode.
Left Soft Key		The left soft key selects the left command bar icon.
Right Soft Key		The right soft key selects the right command bar icon.
Green Call Button		Press to make a call.
Red End Call Button		Press to end a call.

Using the Navigation Keys

Located below the touch panel display, the navigation keys moves the cursor through text, icons, folders, and application screens.

Keypad Combinations

Numeric Keypad	Orange FN Key			Blue FN Key
	Numeric Mode (Default)	Lowercase Mode	Uppercase Mode	Toggle On/Off, the Off mode operates in default mode of Orange FN Key
1 F1 +.,	1	+.,	+.,	F1
2 F2 abc	2	abc	ABC	F2
3 F3 def	3	def	DEF	F3
4 F4 ghi	4	ghi	GHI	F4
5 F5 jkl	5	jkl	JKL	F5
6 F6 mno	6	mno	MNO	F6

Numeric Keypad	Orange FN Key			Blue FN Key
	Numeric Mode (Default)	Lowercase Mode	Uppercase Mode	Toggle On/Off, the Off mode operates in default mode of Orange FN Key
7 F7 pqrs	7	pqrs	PQRS	F7
8 F8 tuv	8	tuv	TUV	F8
9 F9 wxyz	9	wxyz	WXYZ	F9
*	*			
0 F10	0			F10
# ESC SPACE	#	SPACE	SPACE	ESC









System Settings



Overview

The terminal settings can be changed in the *Settings* menu. Tap  > **Settings** and the **Settings** menu opens.



Settings Menu

Icon		Description
Bluetooth		Adjust Bluetooth radio settings. This icon shows only if the Bluetooth radio and driver are installed. See Working with Bluetooth Radio on page 10-1.
Clocks & Alarms		Set the system clock, date, time and schedule alarms. See Clock & Alarms on page 7-2.
Lock		Create a password to limit access to the terminal.
Sounds & Notifications		Set the sound volume, enable or disable sounds, change sound settings, and enable or disable the vibrator.
Home		Change the appearance and information on the Home screen.
Connections		Change the network connections settings. See Connections Menu on page 8-1.
Personal		Change the button settings and set SIP options. See Personal Menu on page 7-3.

Icon		Description
Power		See Power on page 7-13.
System		Change the system settings. See System Menu on page 7-6.
Microsoft My Phone		Synchronize phone contacts, calendar, tasks, text messages, music, photos, videos, and other documents with a My Phone account at http://myphone.microsoft.com .

Clock & Alarms

To adjust the time and date:

1. Tap the time on the Command Bar.
2. Scroll horizontally and tap the **Clock** icon.
3. Tap the **Time** or **Date** sections.

OR

Tap  > **Settings** > **Clock & Alarms**. The **Clock & Alarms** menu opens.



4. Select the **Time** tab. This setting sets the system clock.

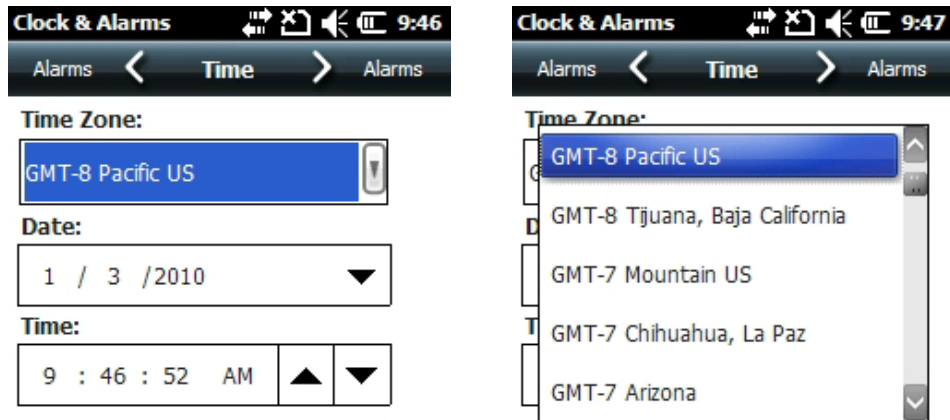

5. Tap the **Time Zone** box to open the drop-down menu.
6. Set the correct time zone from the drop-down menu.
7. Set the correct time and date in the remaining fields.
8. Tap **OK** to save the settings.



Personal Menu

To view the **Personal** Menu:

1. Tap  > **Settings** > **Personal**.



Icon		Description
Buttons		Program buttons on Dolphin 6000 terminal to do specified tasks. See 29-Key Numeric Keypad on page 6-1.

Icon		Description
Owner Information		Enter contact information. This information appears on the Home screen.
Phone		When the GSM radio is turned on, tap this icon to set up user settings and enable or disable the vibrator function. See Setup Options on page 9-5 for system notifications.

Using File Explorer

If a specific program is not found, you can either use **File Explorer** on the terminal to move the program or **ActiveSync** on a workstation to create a shortcut of a program and place the shortcut in the **Start** menu folder.

Note: It is recommended that you Copy and Paste a shortcut so that program settings are not changed by accident. Use the Copy and Paste shortcut to help make sure program files stay where they must be for a system to find them.

1. Tap  > **File Explorer**.
2. Navigate to **My Device > Program Files**.



3. Use the stylus to tap and hold the program. A pop-up menu appears.
4. Tap **Copy** on the pop-up menu.
5. Navigate to the Windows folder and open the **Start Menu (My Device > Windows > Start Menu)**. Then tap and hold a blank area in the window, and tap **Paste Shortcut** on the pop-up menu.

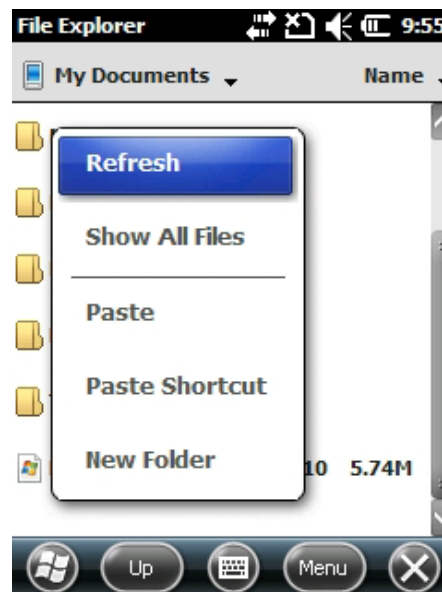

Note: If there is no blank area in the window, tap **Menu > Edit > Paste Shortcut**.

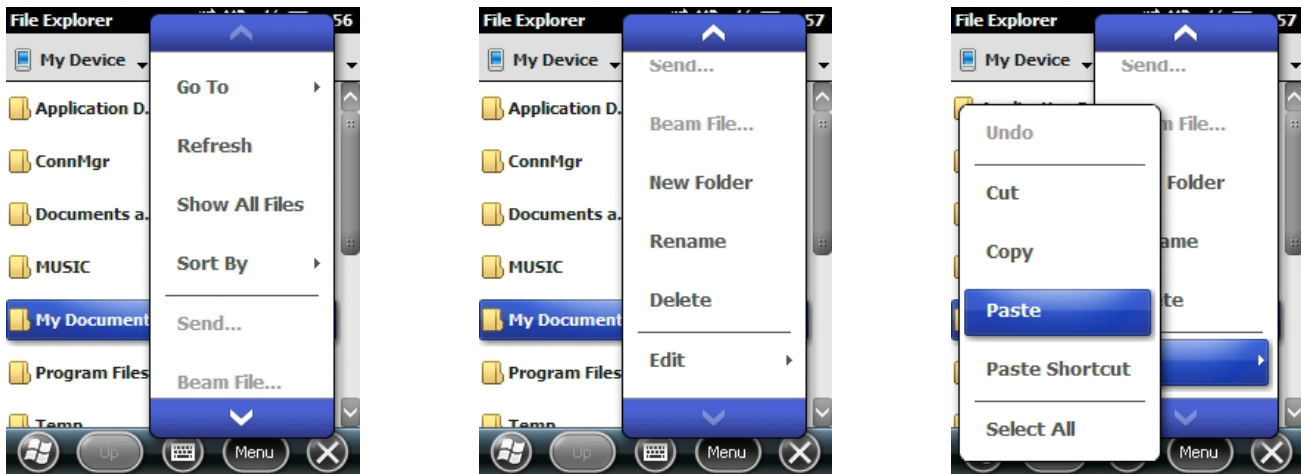

6. Go to the **Start** menu to make sure the copied program is in the **Start** menu folder.

Using ActiveSync on the Workstation

With ActiveSync on the workstation, you perform the same process as on the terminal, except that the Explore utility (Windows Explorer) is used to copy and paste the shortcut.









1. Open **ActiveSync > Explore** and navigate to the program.
2. Right-click on the program and click **Create Shortcut**.
3. Select the shortcut, right-click, and select **Cut**.
4. Navigate to the **Start Menu** folder.
5. Right-click on an empty area and select **Paste Shortcut**.
6. On the terminal, tap the **Start** menu.
7. Verify the program appears.









System Menu

The system settings can be changed in the **System** menu. To access the **System** menu:

1. Go to  > **Settings** > **System**.
2. Tap an icon to open a system setting.



	Icon	See Page
About		See About on page 7-7.
Backlight		See Backlight on page 7-7.
Certificates		See Certificates on page 7-9.
Encryption		See Encryption on page 7-10.
Error Reporting		See Error Reporting on page 7-10.
External GPS		See External GPS on page 7-11.
Managed Programs		See Managed Programs on page 7-11
Memory		See Memory on page 7-11.

	Icon	See Page
Regional Settings		See Regional Settings on page 7-14.
Remove Programs		See Remove Programs on page 7-14.
Screen		See Screen on page 7-15.
Task Manager		See Task Manager on page 7-17.
A-GPS		See A-GPS on page 7-18.
Version		See Version on page 7-18.
Network Time		See Network Time on page 7-18.
Schedule Power On/Off		See Schedule Power On/Off on page 7-18.
HAC Mode		See HAC Mode on page 7-18

About

The About menu shows information about the terminal. There are four tabs:

- Version Tab** Displays information about software, operating system, processor and memory.
- Device ID Tab** Displays information the terminal uses to identify itself to other devices. It is important to know this information if the terminal will be a part of a network.
Device Name: Shows the system's default name. (This is the name used by ActiveSync.)
Description: Shows the description of the terminal ID.
- Copyrights Tab** Displays copyright information.
- Phone Tab** Displays software version, hardware version, Protocol Stack (software) version, Bluetooth firmware version, and IMEI serial number.

Backlight

The Backlight menu adjusts the backlight level of the screen.

To adjust the backlight level settings:

1. Tap  > Settings > System > Backlight.

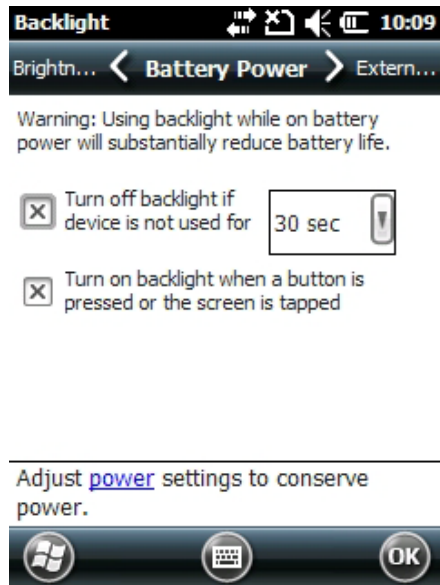

There are three tabs:

Battery Power	Settings for the backlight to turn off when the terminal is using battery power.
External Power	Settings for the backlight to turn off when the terminal is using external power.
Brightness	Settings for the backlight brightness when the terminal is using battery power or external power.

The options on the Battery Power tab and the External Power tab are same.

Turn Off Backlight	Choose this option to turn off the backlight automatically after a designated period of time.
Turn On Backlight	Choose this option for the backlight to turn on when a button or touch screen is tapped with stylus or pressed with your finger.

Backlight Intensity

In the backlight menu, tap the Brightness tab and move the slider to change the screen brightness for battery power and external power settings. The default setting is 4.

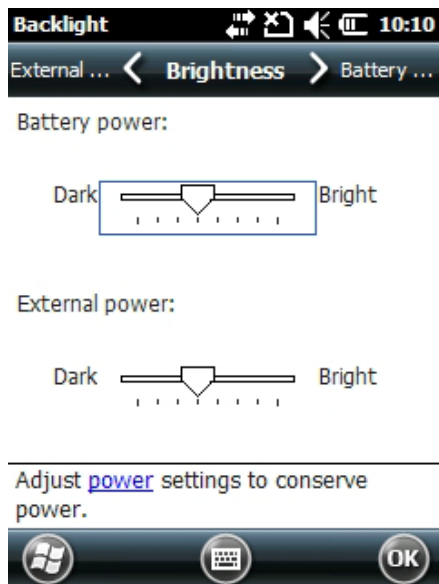

Certificates

The Certificates menu shows certificates that the operating system recognizes.

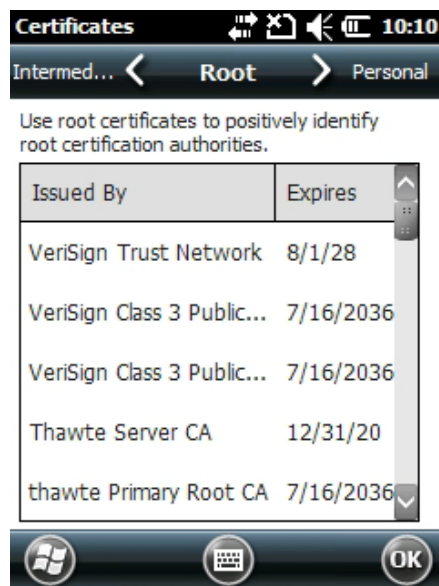

Encryption

The Encryption menu can be adjusted to encrypt files on storage cards so that those files cannot be read by another terminal.

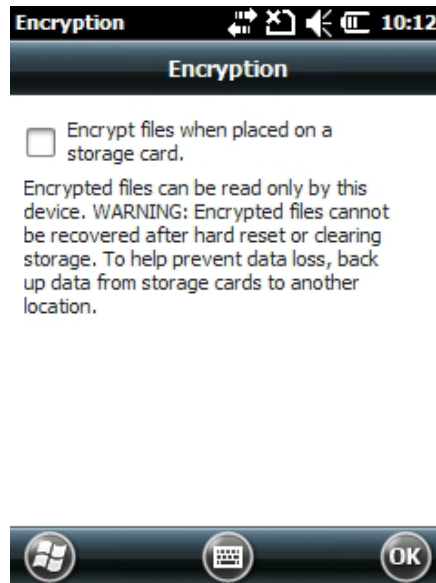

Error Reporting

The Error Reporting menu can be adjusted to enable or disable the error reporting function of Windows Mobile 6.5.

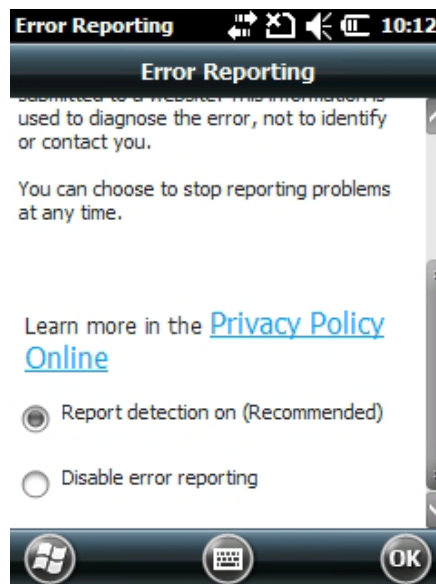

External GPS

The External GPS menu gives you the option to choose a port for a third-party GPS software application to access the GPS receiver.

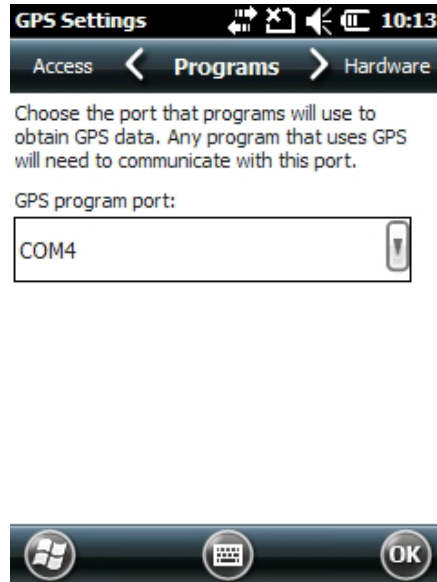

Note: Obtain the GPS program port from the third-party GPS software application vendor.

Managed Programs

Managed Programs is a list of programs that is managed if enrolled to enterprise domain. This option displays the history of .dot net applications that are installed on the device. Managed Programs is the client-side that works with the server product System Center Mobile Device Manager (MDM). MDM consists of MDM Gateway Server and one or more computers that run MDM Device Management Server; MDM Enrollment Server; and Microsoft SQL Server® 2005 databases.

It lets system administrators:

- provide an authenticated connection to LOB applications, managed Group Policy, and application packages.
- use Group Policy and software packages to manage the enrolled Windows phones (enforce policy, wipe devices, etc.).
- manage the requests for and retrieving of certificates for devices and for creating the Active Directory® Domain Service objects that represent these devices. By using these objects, you can manage the devices as if they were members of a domain.

Memory

The Memory menu shows capacity and usage statistics for RAM (volatile and Storage Card non-volatile) memory. View this information when system messages about low memory are received.

The terminal's memory allocation cannot be changed in the Memory menu.

There are two tabs:

- Main
- Storage Card

Main Tab

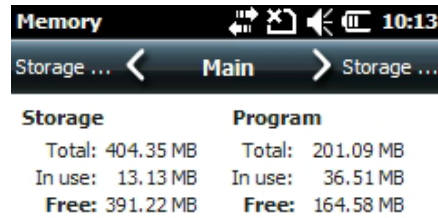

Storage	Program
Total: 404.35 MB	Total: 201.09 MB
In use: 13.13 MB	In use: 36.51 MB
Free: 391.22 MB	Free: 164.58 MB



The **Main** tab shows usage statistics of on-board RAM (volatile) memory.

Columns:

- Storage = FLASH memory used to store programs and program data.
- Program = RAM memory used to run programs.

Rows:

- Total = Shows current Megabytes (MB) of memory that can be used.
- In use = Shows total MB of memory being used.
- Free = Shows total MB of available memory.

Storage Card

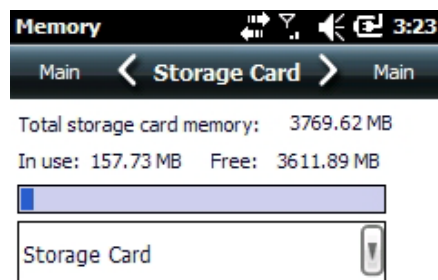

Total storage card memory:	3769.62 MB		
In use:	157.73 MB	Free:	3611.89 MB



Storage Card



The **Storage Card** tab shows capacity and usage statistics of the Storage Card.

Select memory type from the drop-down list.

- Total storage card memory = Total Megabytes (MB) of memory capacity of the Storage Card
- In use = MB currently being used
- Free = MB that can still be used

One memory card can be installed in the Dolphin 6000 terminal. If a memory card is installed in the terminal, select it in the drop-down list to see the capacity and usage statistics for the card.

Power

The Power settings menu has two tabs:

- Battery
- Advanced

Battery

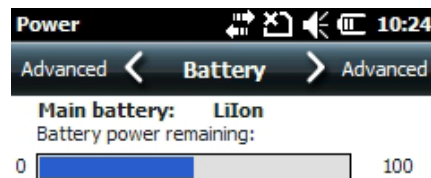

Note: For more information, see [Battery Pack](#) on page 3-10.

Advanced Tab

In the Advanced tab, you can adjust settings so the screen turns off when the terminal is not in use.

To change the settings for On battery power:

1. Tap the box that shows the time. A drop-down list opens.
2. Set the amount of time to pass before the screen turns off when the terminal is not in use.

To change the settings for On external power:

1. Tap the box that shows the time. A drop-down list opens.
2. Set the amount of time to pass before the screen turns off when the terminal is not in use.

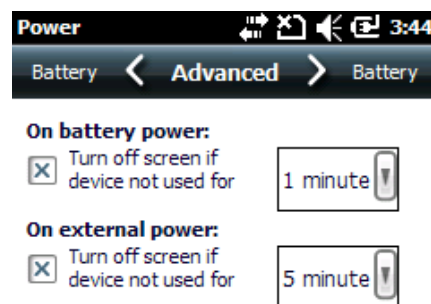

Note: There is an option to set automatic turn-off times for the terminal to save power. When the terminal is turned off, it means that the terminal is in Suspend Mode. See [Suspending/Resuming Terminal](#) on page 3-11.

Regional Settings

Regional Settings enables you to customize the appearance and formatting to your geographic region. Specifically, you can customize numbers (i.e., the number of decimal places allowed), currency (i.e., using the \$ symbol), time and date. These settings apply to all screens. The **Region** tab shows the region in the drop-down list at the top.

The terminal has many pre-programmed regional settings. Choose one from the list and the results appears on the screen.

To see the settings or to change a setting:

1. Choose a tab.
2. Make a change.
3. Tap **OK** on the Command bar to save the setting.

Remove Programs

Remove Programs enables you to remove programs installed on the terminal. The programs will be removed from the memory. Any program (usually CAB or DLL files) saved in the Auto-install folder (**My Device > Honeywell > Autoinstall**) re-installs after a hard reset.

Note: For information about the hard reset process, see [Turning Terminal On/Off](#).

1. Tap the **Remove Programs** icon.
2. Select a program to remove.

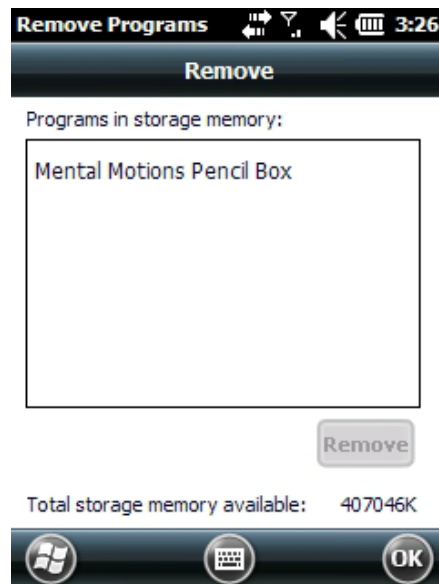

3. Tap **Remove**. The following message appears.

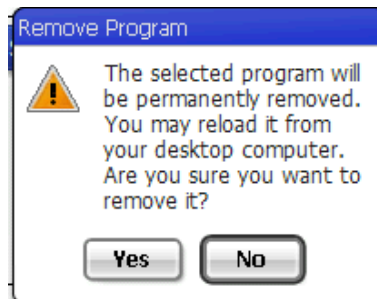

4. Tap **Yes**. Wait for the program to be removed.
5. Verify that the program no longer appears in the list.

Screen

The Screen menu has three tabs:

- General
- ClearType
- Text Size

General Tab

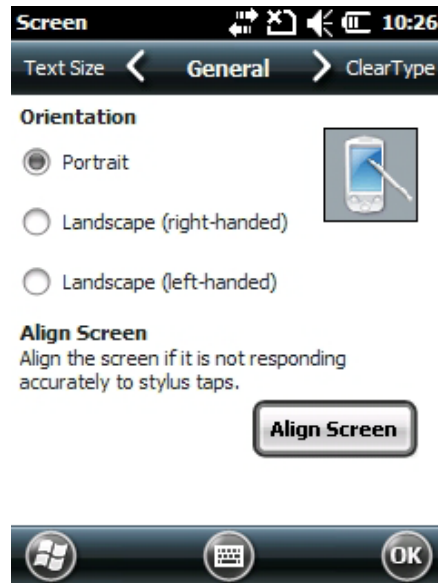

Orientation

The General tab is used to set dynamic screen rotation. There are three types of screen orientations:

- Portrait
- Landscape (right-handed)
- Landscape (left-handed)

Align Screen

The General tab allows you to re-align the screen. You need to re-align the screen if tapping buttons or icons with the stylus does not work correctly.

1. Tap the **Align Screen** to open the align screen window.
2. Tap the target with the stylus each time it appears. This re-calibrates the touch screen.
 - Aligning the screen must be done using the stylus. The stylus tip is necessary for calibration.
 - Tap the stylus in the center of the target once and release. Do not tap the target more than one time.

ClearType Tab

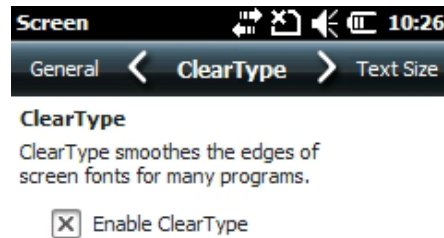

The screen supports ClearType font rendering, which increases the readability of text on LCD displays.

To turn on ClearType font rendering, tap **Enable ClearType** and tap **OK**.

Note: For more information about ClearType font rendering, visit: www.microsoft.com/typography/WhatIsClearType.mspx.

Text Size Tab

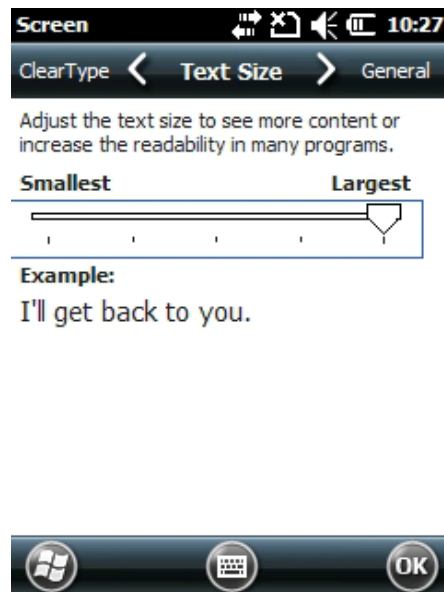

The Text Size tab enables you to perform font scaling on the:

- Home screen
- Contacts
- Calendar
- Messaging
- Tasks

Font scaling means the point size of the fonts can increase or decrease in applications.

To change the font size:

1. Move the slider to Smallest or Largest. The Example text changes to show the font change.
2. Tap **OK** to save the font size setting.

Task Manager

The Task Manager displays information about applications and processes that are being used on terminal. Use Task Manager to view memory and CPU usage of applications and processes. View Task Manager when memory errors are received or when the terminal operation is slow.

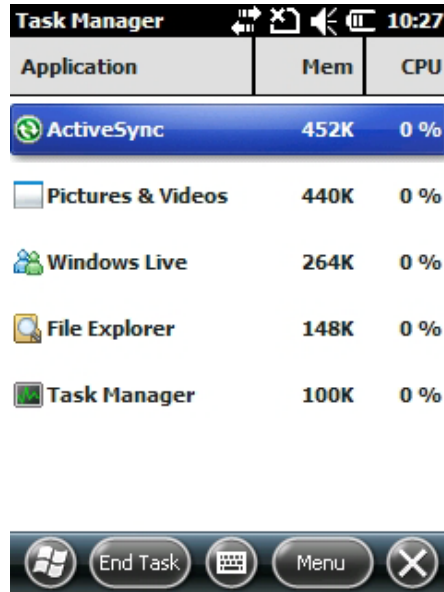

Application	Mem	CPU
ActiveSync	452K	0 %
Pictures & Videos	440K	0 %
Windows Live	264K	0 %
File Explorer	148K	0 %
Task Manager	100K	0 %

Below the table is a command bar with icons for Windows, End Task, Keyboard, Menu, and Close.

Using the Task Manager Applications

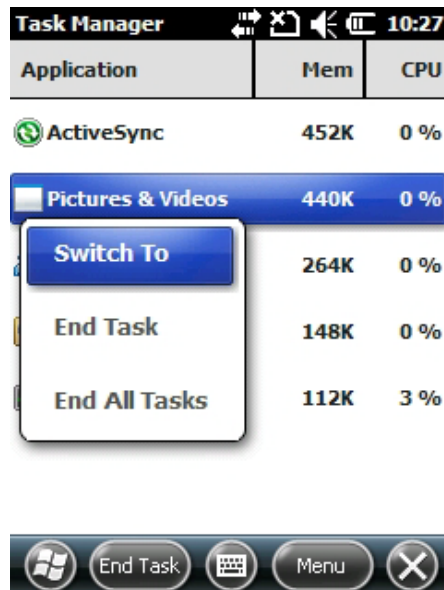

Application	Mem	CPU
ActiveSync	452K	0 %
Pictures & Videos	440K	0 %
Windows Live	264K	0 %
File Explorer	148K	0 %
Task Manager	112K	3 %

A context menu is open over the 'Pictures & Videos' application, showing the following options: Switch To, End Task, and End All Tasks.

Below the table is a command bar with icons for Windows, End Task, Keyboard, Menu, and Close.

To see the status of programs running:

1. Tap **Menu** button on the Command bar
2. Tap **View > Applications**.
3. Tap and hold on an application

4. Tap **Switch To** on the pop-up menu.
5. Tap and hold on an application.
6. Tap **End Task** or **End All Tasks** on the pop-up menu.

Note: Stopping a program frees up RAM memory. If you stop a program in Task Manager, unsaved data in that program is lost. To make more memory available without the risk of data loss, return to the active program and save the data before closing the program.

Processes

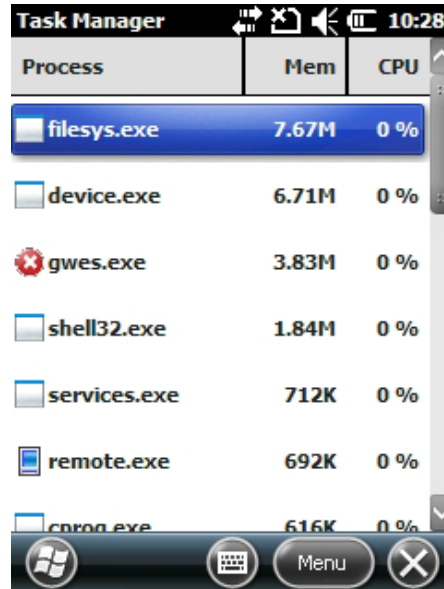

Process	Mem	CPU
fileys.exe	7.67M	0 %
device.exe	6.71M	0 %
gwes.exe	3.83M	0 %
shell32.exe	1.84M	0 %
services.exe	712K	0 %
remote.exe	692K	0 %
cmd.exe	616K	0 %

To view information about processes running on the terminal:

1. Tap the **Menu** button on the Command bar.
2. Tap **View > Processes**.

A-GPS

When enabled, the device uses a data connection (Internet or other) to contact the assistance server for GPS information. This feature improves the startup performance or time-to-first-fix (TTFF) of a GPS satellite-based positioning system.

Version

The Version option displays information about the operating system and Bootloader version.

Network Time

Enables Network Time Zone synchronization. You can synchronize the device to the current time zone and be notified when a time is updated.

Schedule Power On/Off

This feature enables you to turn the device on and/or off at a particular time.

HAC Mode





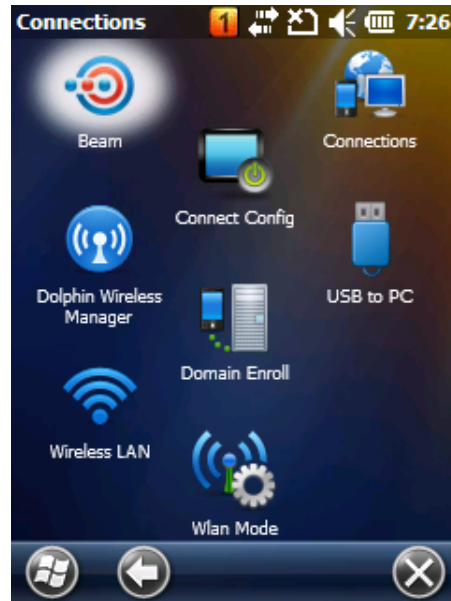

This feature enables you to put the Dolphin 6000 in hearing aid compatible mode improving the usability of the terminal for hearing aid users.

Communication

Connections Menu

The Connections menu provides access to the terminal's wireless communication options.



Icon		Description
Beam		Enables Bluetooth file transfer.
Connections		Opens Microsoft's connections manager. Refer to Connections Manager on page 8-2.
Dolphin Wireless Manager		Manages the wireless radios installed on the terminal. Refer to Dolphin Wireless Manager on page 8-3.
USB to PC		Enables advanced wired USB to PC communication via sync software. Refer to Connecting and Synchronizing the Terminal and Workstation on page 8-4.
Wireless LAN		Enables configuration of Wireless Zero Config (WZC). This icon appears only if the 802.11b/g driver is loaded on the terminal and the WLAN Security Supplicant is not loaded. By default, the Wireless Zero Config is disabled and the supplicant is loaded. This icon appears only if you removed the supplicant and cold booted the terminal.
Domain Enroll		Connects the phone to the company resources.
Connect Config		Enables automatic data configuration.

Icon		Description
WLAN Mode		Enables WLAN configuration.

Note: All server-assigned IP addresses use Dynamic Host Configuration Protocol (DHCP).

Connections Manager

Microsoft's Connections Manager sets up multiple network connections to the Internet Service Providers (ISPs) via the external modem.

Note: Do not enter connection parameters in the connections manager if:

- You are using one of the on-board wireless radios to connect to a network. The Dolphin 6000 terminal uses the settings from each radio's configuration utility to connect.
- You are using Wireless Zero Config. By default, WZC is disabled on Dolphin 6000 terminals.

To open the **Connections Manager**, navigate to  > **Settings > Connections > Connections.**

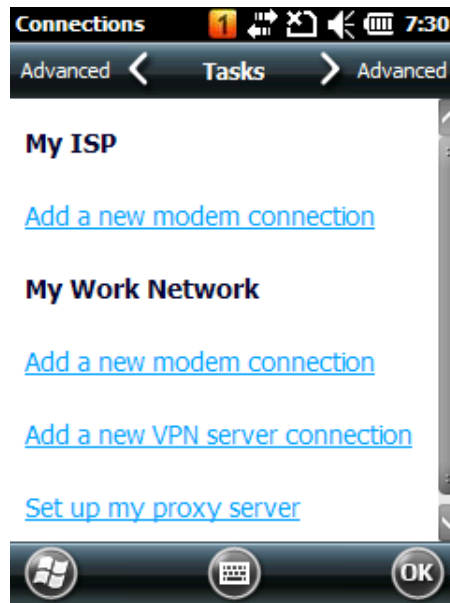

Tasks Tab

The Tasks tab enables you to initially configure and to then manage network settings when using a modem. Select an item from the menu and follow the instructions on the screen to complete the network configuration.

My ISP

Enables you to add and manage modem connections to an ISP. To complete the setup screens, obtain the following information from the ISP:

- ISP dial-up access telephone number
- Username
- Password
- TCP/IP settings

My Work Network

Enables you to establish the following connection types:

- Modem
- Virtual Private Network (VPN)
- Proxy server connection

Note: If you are connected to your ISP or private network during synchronization, the terminal downloads the proper proxy settings. If the network connection is not configured on the PC or needs to be changed, then the ISP or network administrator should provide the following information: proxy sever name, server type, port, type of Socks protocol used, and user name and password.

To complete the setup screens, obtain the network parameters from your system administrator.

Advanced Tab

The Advanced tab enables you to select the following:

- Default network
- Dialing rules
- IP address exceptions for modem connections.

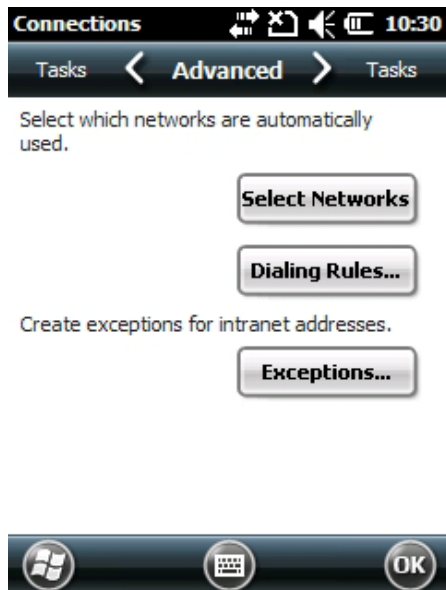

Note: Advanced settings should not be need to be modified. Most ISPs use DHCP addresses.

Online Help

For more information about modem connection setup, tap the Help icon on the setup screens.

Dolphin Wireless Manager

The Dolphin Wireless Manager provides a centralized interface that enables and disables all the on-board radios. Each radio has its own configuration program. The Dolphin Wireless Manager also provides shortcuts to the configuration utilities for each radio.

Dolphin Wireless Manager Window

1. Tap  > **Settings** > **Connections** > **Dolphin Wireless Manager**.

Enabling the Radios

1. Tap  > **Settings** > **Connections** > **Dolphin Wireless Manager**.
2. Tap anywhere inside the rectangle or the **OFF** button inside the rectangle.
3. The radio begins activating.
4. When the radio is activated (i.e., transmitting a signal), the **OFF** button changes to **ON**.

Note: If applicable, information about the radio appears in the rectangle.

Accessing Radio Configuration Utilities

Each radio has its own configuration utility that you can access by tapping **Menu** on the command bar.

Radio Type	Menu Option
802.11a/b/g	Tap WLAN Settings and the Honeywell WLAN Security Supplicant opens. The <i>Honeywell WLAN Secure Wireless Client (SWC) User's Guide</i> is available for download from the Dolphin 6000 product page at www.honeywellaidc.com .
Bluetooth	Tap Bluetooth Settings and the Bluetooth Settings open. For details, see Working with Bluetooth Radio on page 10-1.
GSM/GPRS/EDGE	Tap Phone Settings and the Phone opens. For details, see Working with GSM/GPRS/EDGE on page 9-1.

Connecting and Synchronizing the Terminal and Workstation

Note: If the workstation is running Windows Vista or Windows 7, you will need to use Windows Mobile Device Center to synchronize data between your terminal and workstation.

To synchronize data between the terminal and the workstation, ActiveSync (version 4.5 or higher) or Windows Mobile Device Center must be installed and configured for the appropriate communication type on the host workstation (Windows-based PC) and the Dolphin terminal. Dolphin terminals ship with ActiveSync already installed. Therefore, if ActiveSync or Windows Mobile Device Center is already installed on the host workstation, you just need to connect the Dolphin terminal to the host workstation (via Dolphin peripheral) to initiate communication.

If ActiveSync (4.5 or higher) or Windows Mobile Device Center is not installed on the host workstation, you can download and install the most current version of the software from the [Microsoft Web site](http://go.microsoft.com/fwlink/?LinkId=147001) (<http://go.microsoft.com/fwlink/?LinkId=147001>).

Note: Note: ActiveSync on your Dolphin terminal works with Windows Mobile Device Center on host workstations running Windows Vista or Windows 7 and with ActiveSync on host workstations running Windows XP. For detailed information on ActiveSync and WMDC visit the [Microsoft Windows Phone Web site](#).

If ActiveSync 4.5 or higher/Windows Mobile Device Center is not installed on the host workstation, download the latest version of the program from www.microsoft.com.



When communicating via ActiveSync or Windows Mobile Device Center, your terminal is designed to be connected to the host workstation with a communication peripheral sold/manufactured by Honeywell, such as the charge/communication cable. Use of any peripheral not sold/manufactured by Honeywell may cause damage not covered by the warranty.

Note: If communication in ActiveSync or Windows Mobile Device Center fails, remove the USB Communication Cable and connect the USB Communication Cable to the host workstation again to initiate the process.

Capabilities

The following is a list of the procedures you can do with ActiveSync or Windows Mobile Device Center:

- Back up and restore the terminal data
- Copy (rather than synchronize) files between the terminal and workstation.
- Control when synchronization occurs by selecting a synchronization mode. For example, you can synchronize continually while connected to your workstation or only when you choose the synchronize command.
- Select which information types are synchronized, controlling how much data is synchronized. For example, you can choose how many weeks of past appointments you want synchronized.

Communication Types

The Dolphin 6000 terminal supports the following type of communication via ActiveSync or Windows Mobile Device Center through its I/O Connector (see [I/O Connector](#) on page 3-9) on the bottom panel:

USB The USB Communication Cable allows the terminal to communicate with a workstation or be networked through a USB hub. The Dolphin 6000 terminal supports high-speed USB communication (USB 2.0) with maximum data transfer rate of 480 Mbps.

Software Requirements for Communication

To synchronize successfully, ActiveSync v4.5 or higher or Windows Mobile Device Center must be configured for the same communication type on the host workstation and Dolphin 6000 terminal.

Note: ActiveSync or Windows Mobile Device Center must be setup on the workstation before initializing synchronization from the terminal for the first time.

The following is a list of the supported operating systems:

- Windows XP
- 2003 Server
- Windows Vista
- Windows 7

Setting Up the Host Workstation

To synchronize data between the terminal and the workstation, ActiveSync (v4.5 or higher) or Windows Mobile Device Center must be configured for same communication type on both the host workstation and the Dolphin terminal.

1. Verify that ActiveSync is configured to use the appropriate communication type by tapping **File > Connection Settings**.
2. Check the box next to **Allow USB connections**.

Connecting the Dolphin Terminal to the Workstation

After setting up the workstation and the terminal:

1. Connect the Dolphin 6000 terminal to the workstation using the USB Communication cable.
2. ActiveSync or Windows Mobile Device Center should open and connect automatically to the Dolphin terminal.

Synchronizing with the Host Workstation

The synchronization process begins automatically after setup, if ActiveSync or Windows Mobile Device Center has been installed on the host workstation and the workstation has been connected to the terminal.

Exploring the Terminal from the Workstation

ActiveSync

1. Open the main ActiveSync window (on the desktop).
2. Click **Explore**. The **Mobile Device** folder opens in **Windows Explorer**.
3. The Dolphin 6000 terminal is treated as a mass storage device. You can transfer files by dragging and dropping the files or copying and pasting them.

Windows Mobile Device Center

1. Open the Windows Mobile Device Center (on the desktop).
2. Click **File Management**. This opens the **Mobile Device** folder for the terminal.
3. The Dolphin terminal is now treated as a mass storage device. You can transfer files by dragging and dropping the files or copying and pasting them.

Installing Additional Software

In addition to the default programs installed on your terminal, you can install any program designed for Windows Mobile-based devices, as long as the terminal has enough memory to store the program and the program has an EXE, CAB, or DLL extension.

The most popular place to find the software is on the Windows Mobile website: www.microsoft.com/windowsmobile/en-us/downloads/default.aspx.

Adding Programs to the Terminal Using ActiveSync or Windows Mobile Device Center



When selecting programs, verify that the program and version of the program are designed for Windows Mobile and processor. To verify the processor tap  > **Settings** > **System** > **About** > **Version**.

Depending on the application, the software must be stored or installed on the host PC.

1. Download the program to the desktop computer from the Internet, CD or disk. It can be a single *setup.exe*, *EXE*, *CAB*, or *DLL*-file or several files for different types of devices and processors.
2. Many programs provide special installation instructions. Read the installation instructions in Read Me files, or documentation that comes with the program.
3. Connect the terminal to the desktop computer via a Honeywell communication peripheral.

Installer File

An installer program is one that installs on the PC and the terminal simultaneously. Perform the following:

1. On the PC, double-click the **.setup.exe* or *EXE* file. The installation wizard begins.
2. Follow the directions on the PC screen. The installation process includes transferring the software to the terminal.



Non-Installer File

There are programs that cannot be installed on PCs because they are designed for terminals. In these cases, the appropriate files must be stored on the host PC, transferred via ActiveSync, and installed on the terminal. If the instructions cannot be found in the Read Me file or documentation, perform the following:

1. Store the appropriate file or files on the host PC.
2. Open ActiveSync and click **Explore**, or Open Windows Mobile Device Center and click **File Management**.
3. Click on the **My Windows Mobile-Based Device** folder and copy the program file or files to the **Program Files** folder on the terminal.

*Note: If you want the program to be autoinstalled, place the file in the Autoinstall folder located at **My Windows Mobile-Based Device** > **Honeywell** > **Autoinstall**.*

4. If the file or files have been copied to the Autoinstall folder, you can tap on the program inside the folder or perform a hard reset and the program installation starts automatically. For more information, refer to [Turning Terminal On/Off](#).

After the installation on the terminal is complete, tap . The program and its icon appears on the  screen. Tap the icon to run the program.

Adding Programs Directly from the Internet

When selecting programs, verify that the program and version of the program are designed for Windows Mobile and the terminal's processor.

Perform the following:

1. Choose the version of the software that is designed for the specific device and processor. The processor can be verified by tapping on  > **Settings**> **System**> **About** > **Version** tab. Make a note of the information in the **Processor** field.
2. Download the program to the terminal from the Internet, using Internet Explorer Mobile. It can be a single *setup.exe*, *EXE*, *CAB* or *DLL*-file or several files for different types of terminals and processors.
3. Many programs provide special installation instructions. Read the installation instructions in Read Me files or documentation that comes with the program.
4. Tap the file, such as an *EXE* file. The installation wizard begins. Follow the directions on the screen.

COM Port Assignment Table

COM Port	Description
COM0	Not accessible
COM1	GPS
COM2	Bluetooth
COM3	Serial Port: RS232 Connector on the bottom panel
COM4	Unused
COM5	Unused
COM6	Unused
COM7	Unused
COM8	Unused
COM9	BT BTHATCI server



Working with GSM/GPRS/EDGE

Overview

The Dolphin 6000 terminal is designed with an integrated, embedded GSM/GPRS/EDGE radio module for WWAN communication.

GSM	Global System for Mobile communications, GSM, is an open, non-proprietary wireless WAN system.
GPRS	General Packet Radio Service, GPRS, is a non-voice service that allows packet-switched data to be instantly sent and received across mobile telephone networks.
EDGE	E-GPRS is a non-voice service that allows packet-switched data to be instantly sent and received across mobile telephone networks at a higher data rate than standard GPRS.

Requirements

Using GSM/GPRS/EDGE requires:

- Network subscription to a GSM/GPRS/EDGE network (you must know what service providers are in your geographic area)
- An installed SIM card that has been activated by the network service provider (see [Installing a SIM Card](#), page 9-2).

Voice and Data Communication

Dolphin 6000 terminals with integrated GSM/GPRS/EDGE radios are best for the following two-way voice and data communications:

- Voice: GSM voice data (dial-up)
- Data: Available speed depends on the wireless network carrier and their supported packet-data technology and network conditions.
- GPRS Class 10: data transmission max. 85.6 kbps (DL), max. 42.8 kbps (UL)
- EDGE (E-GPRS) Class 10: data transmission max. 237 Kbps (DL), max. 118 kbps (UL)

GSM radio for voice communication and data communication can be used, but not at same time. If making a voice call, the terminal cannot send data. If sending data, the terminal cannot make voice calls.

SIM Card Installation

A Subscriber Information Module (SIM) card contains subscriber's personal information, GSM/GPRS radio settings, security keys, contacts, etc. SIM cards can be installed in compatible mobile terminals that can switch terminals without losing personal and setup information.

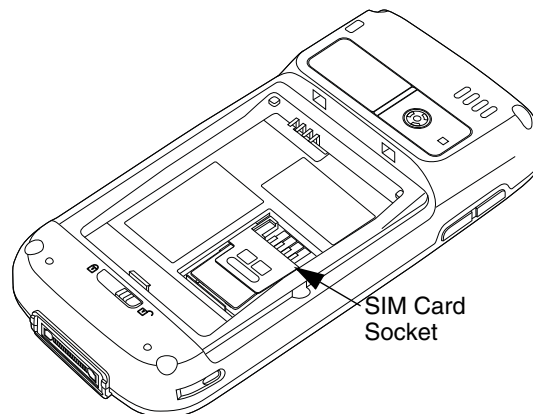

SIM Card Requirements

Before installing the SIM card:

- The service provider must activate the SIM card.
- The terminal must be turned off.

Note: If no SIM card is installed, emergency phone calls such as 9-1-1 can still be made.

Installing a SIM Card

1. Power down the terminal.
2. Unlock and remove the battery door.
3. Remove the battery.
4. Slide the latch toward the top of the terminal to unlock the SIM card.

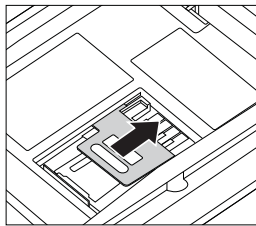

5. Lift the SIM card latch.

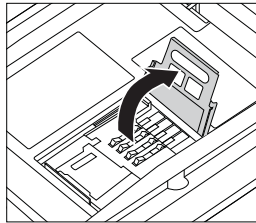

6. Insert the SIM card into the SIM card socket.

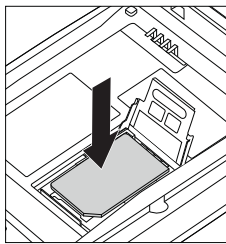

Note: Make sure the interface on the card is connected to the SIM Card interface in the socket, align the corner of the card with the corner of the socket.

7. Close the SIM card latch.

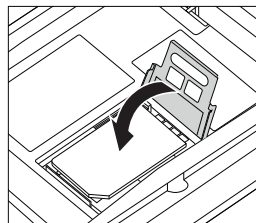

8. Lock the SIM card latch by sliding the latch toward bottom of terminal.

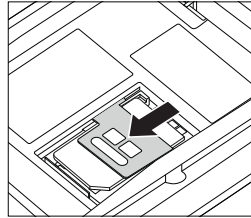

9. Install the battery.

10. Install and lock the battery door.

11. Power on the terminal.

Enabling the GSM Radio

By default, the GSM radio is not enabled after a hard reset. Verify the status of the radio in the Dolphin Wireless Manager.

Tap  > **Settings > Connections > Dolphin Wireless Manager.**

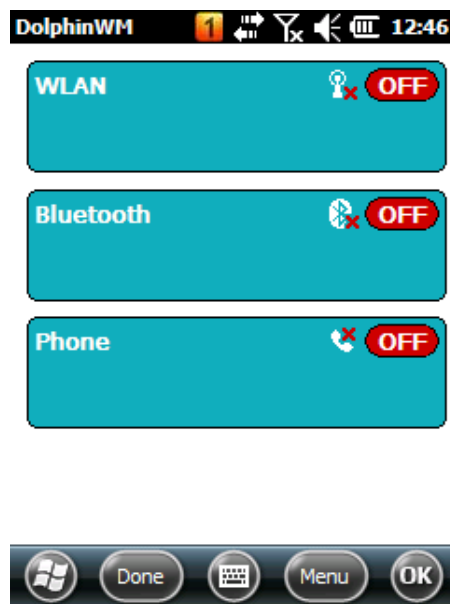

If the Phone is set to OFF, tap the Phone rectangle and the GSM radio enables.

Voice Communication

Dolphin 6000 terminal can operate as a phone over GSM radio.

Audio Modes

Hands-free Mode Hands-free mode is when you use the rear speaker as a speakerphone. To switch to speakerphone, tap on the speaker button in the Dialer window.

Volume Control

Press the up or down arrow on the Volume Control button on left side of terminal to adjust volume of speaker. For more information, see [Volume Control Button](#), page 3-5.

Accessing the Dialer Window

Tap  > **Phone** or press the Green Call button.
The Phone dialer opens.



Dialing

Once the dialer window is open, the terminal can dial two ways:

- Use the touch screen and tap buttons on the dialer window.
- Use the physical keypad (when keypad is in numeric mode).

Sending Calls

After a number is dialed, tap **Talk** on the screen or press the green call button on keypad.



Note: The Voice call in progress icon in the navigation bar indicates that the phone is in use.

Ending Calls

While the phone call is active, tap **End** on the screen or press the red end call button on keypad.

Accessing Voice Mail

Tap  > **Phone** -> **Speed Dial** -> **Voice Mail** -> **Call**.

Note: Update the voice mail retrieval number by turning off the terminal and then turning on the terminal via the Dolphin Wireless Manager. See [Enabling the GSM Radio](#), page 9-3.

View Options

Tap **Menu** -> **View**.

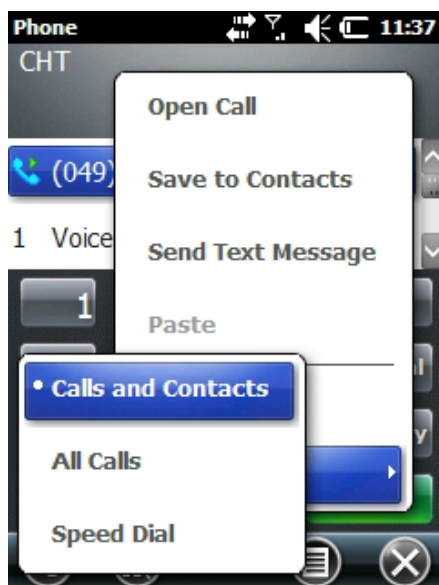

Setup Options

Tap **Menu** -> **Options**. The Phone menu opens and the sounds, services, network and security tabs appear.

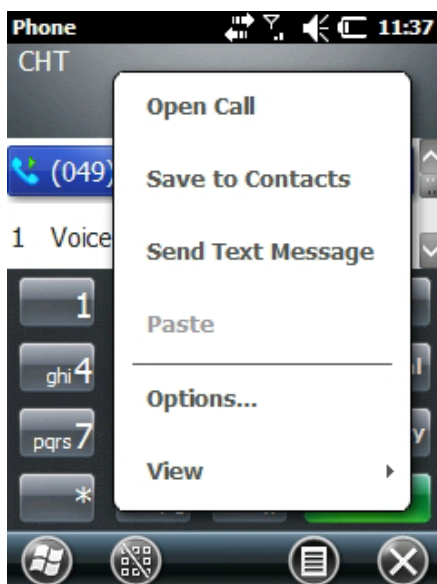

Sounds

In the **Sounds** tab, ring tones, ring types, and keypad sounds can be changed.

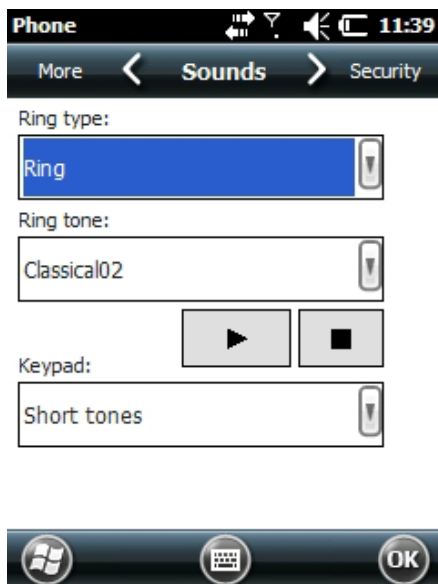

Services

The phone reads settings for each service on the SIM card and shows the available options from carrier.

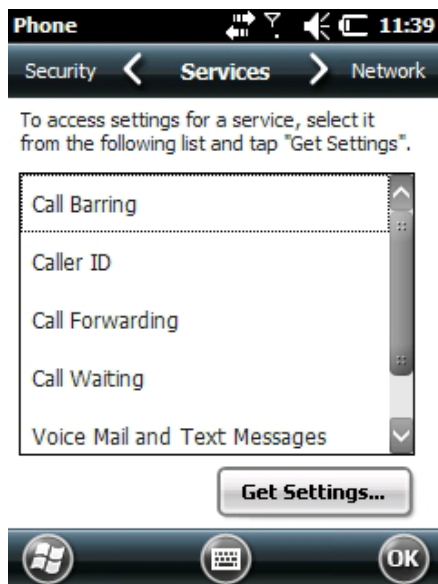

Network

The Network tab displays options to find and set networks.

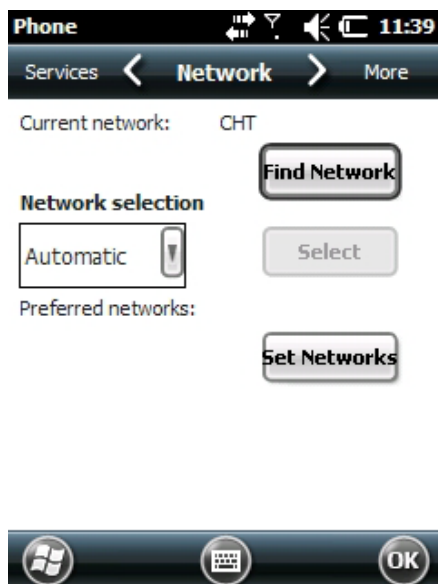

Security

You can make or change a PIN on the Security tab.

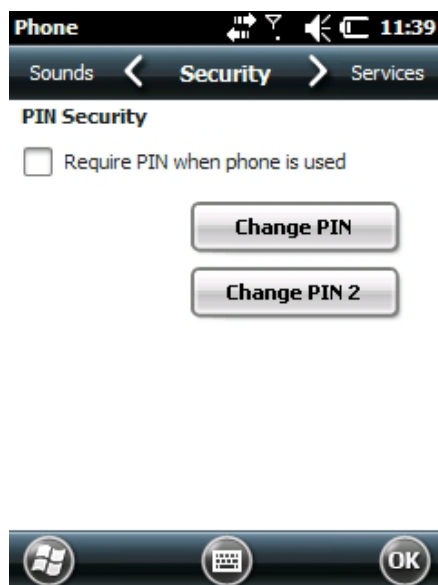

Data Communication

You set up data communication via the Connections Manager. The carrier on the SIM card is the ISP.

System Requirements

- The GSM radio must be enabled. Refer to [Enabling the GSM Radio](#) on page 9-3.
- You must have an active SIM card with a data plan installed. Refer to [SIM Card Installation](#) on page 9-1.

Information Requirements

The following is required from SIM card carrier:

- APN (access point name).
- Username and password of account.

Establishing Data Communication

1. Tap  > **Settings** -> **Connection** -> **Connections**.
2. Under My ISP, tap **Add a new modem connection**.
3. Enter a name for connection. Select Cellular Line (GPRS) as modem
4. Tap **Next**.

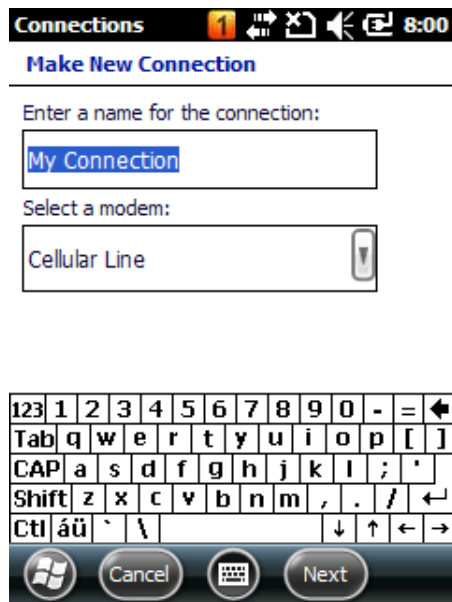

5. Enter an Access point name. Tap **Next**.

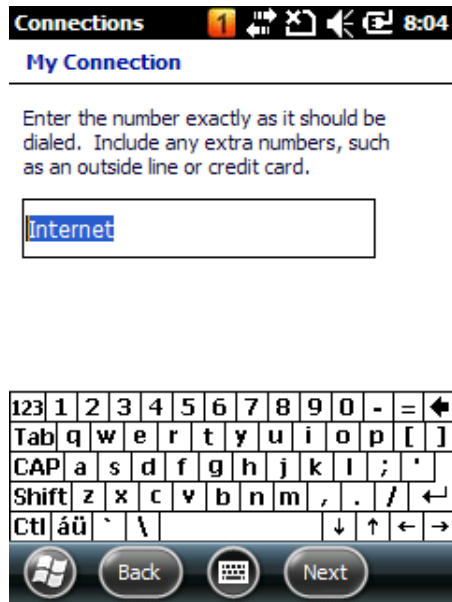

6. Enter a username and password from the account. Tap **Finish**.

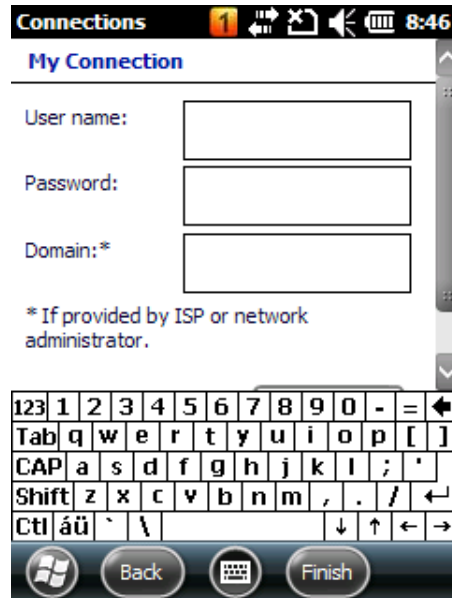

7. In the Connections window, tap **Manage existing connections**. The new connection should show on the list in the modem tab.

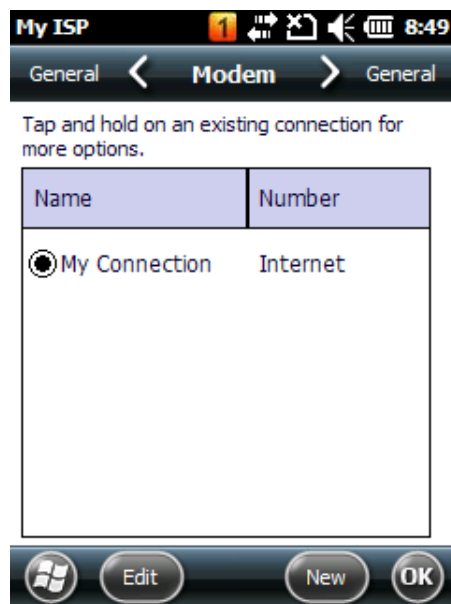

8. Press and hold the connection. A pop-up menu appears.
9. Select **Connect** on the pop-up menu.

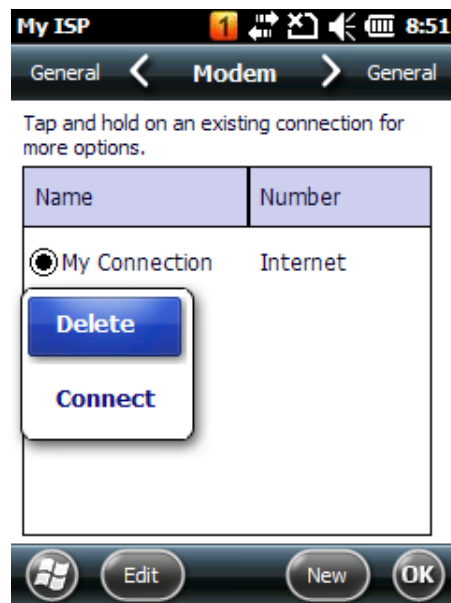

10. The network icon in the navigation bar shows GSM radio is attempting to connect.

Note: Data connection failure occurs if terminal is in use for a voice call while attempting a data connection. Voice and data cannot be used at the same time. A voice call has priority over a data connection. Active data connection is automatically set in "park" mode and data is "retrieved" when the voice call ends.

11. When the connection is complete, the network icon changes to a Signal Strength Icon. Data can now be sent over GSM.

Ending the Data Connection

The default setting makes the data connection disconnect after a specific amount of time passes without use. This amount of time is determined by the ISP.

To end data connection manually, tap the **network icon** in navigation bar and tap **Disconnect** on the pop-up menu.

Manual Network Selection

Select either the **Automatic** or **Manual** network selection in the **Network** tab. The terminal defaults to Automatic network selection.

1. When an active SIM card is inserted in terminal, tap  > **Settings** -> **Personal** -> **Phone** -> **Menu** -> **Options**. The Phone menu window opens.
2. Select the **Network** tab.

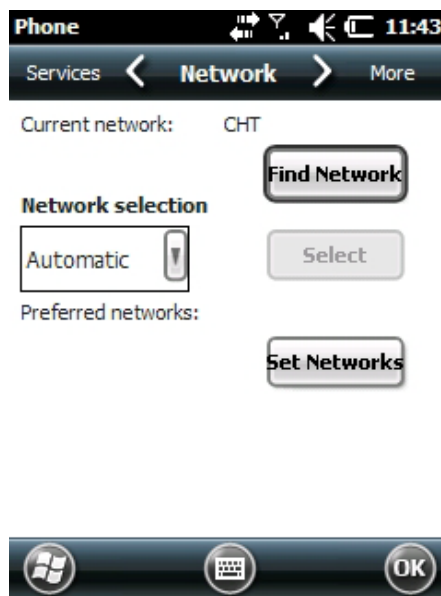

3. Under **Network** selection, choose **Automatic** (the default setting) or **Manual**.

a. If you selected **Manual**, the terminal searches for available networks.

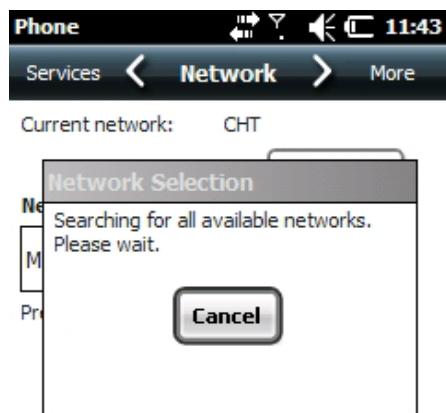

b. The available networks display.

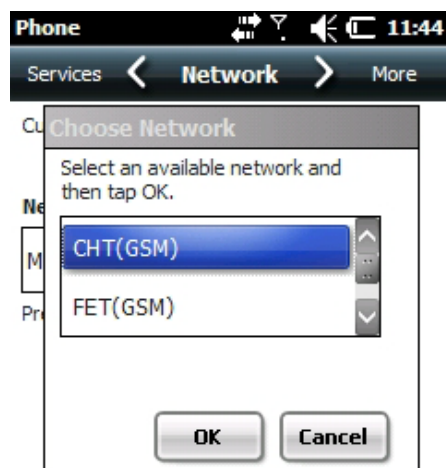

c. Choose a new network and tap **OK**. The terminal registers on the new network and the **Network** tab opens.

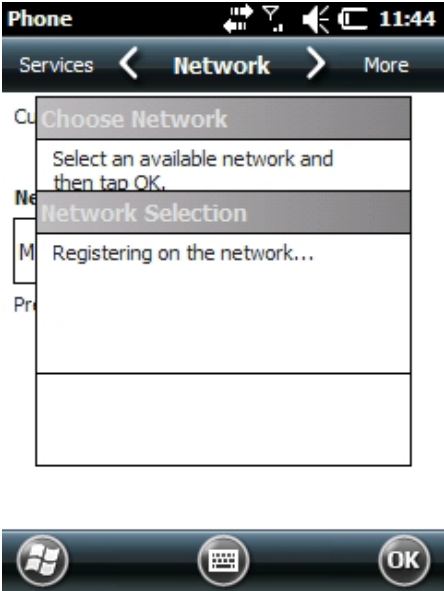



- d. To switch to another network, tap the **Select** button and the process repeats.
- 5. To switch back to automatic roaming, select **Automatic** under **Select networks** and tap **OK**.



Working with Bluetooth Radio

Enabling the Bluetooth Radio

You enable the Bluetooth radio in the [Dolphin Wireless Manager](#) on page 8-3.

1. Tap  > **Settings** > **Connections** >  on the Home screen to access the **Dolphin Wireless Manager**.

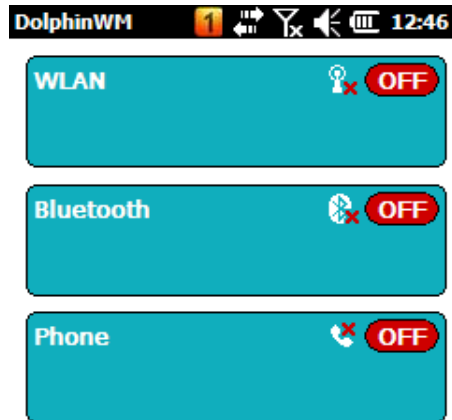

2. Tap anywhere inside the Bluetooth rectangle and Bluetooth begins activating.

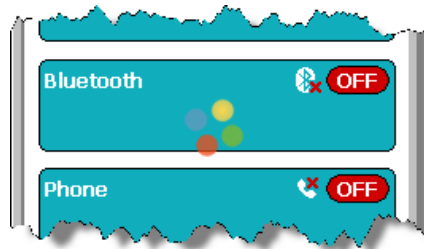

3. When the radio is activated (i.e., transmitting a signal), the **OFF** button changes to **ON**.



Now, the Bluetooth radio is transmitting a signal. Additional text in the Bluetooth section tells information about the Bluetooth radio. “Visible” and “Not visible” indicates whether the Bluetooth radio is discoverable or not discoverable by other Bluetooth devices.

Now, you can connect to other transmitting and discoverable Bluetooth devices ([see page 10-2](#)).

To make the terminal discoverable, [see page 10-5](#).

Pairing and Trusted Devices

The terminal does support pairing. Pairing happens during general connection setup. Paired devices are "trusted" devices. This means that there is unrestricted access to all services (including services that require authorization and authentication).

A connection can exclude pairing. A device that is connected to the terminal but not paired with it is considered an untrusted device. Content can still be passed to untrusted devices by requiring authorization with each attempt (for example, with the initialization of a file exchange). The Beam File method of file transfer can be used to pass a file as an untrusted device; see [Transferring Files](#) on page 10-4.

Connecting to Other Bluetooth Devices

To connect to other bluetooth devices, you need to perform a device discovery, select a discovered device, and then connect to the selected device. Pairing happens as part of the connection process.

1. Make sure the Bluetooth device is in range and set to be discoverable by other Bluetooth devices.
2. In the Dolphin Wireless Manager, tap **Menu > Bluetooth Settings**.

OR

Tap  > **Settings > Bluetooth** .

3. Tap **Add new device**. The terminal begins searching for discoverable Bluetooth devices.

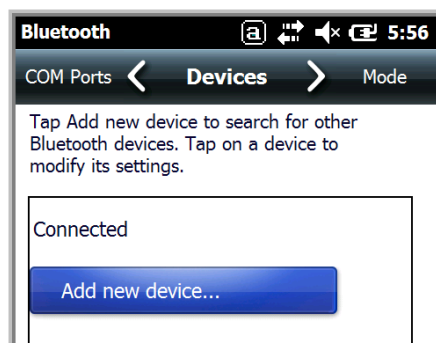

4. Select a device from the list and tap **Next**.

The types of devices in the vicinity of the radio appear in the list of discovered devices.

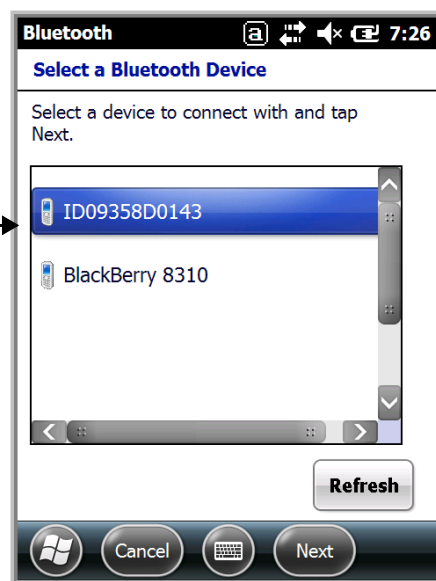

5. You are prompted to enter a passcode.

If the device has a specific passcode, enter it in the **Passcode** field and tap **Next**.

When attempting to connect to a printer or headset with Bluetooth capabilities, the passcode may default to either 1111 or 0000. If there is no default, consult the device literature for the number.

If the device does not have a specific passcode, enter one in the **Passcode** field and tap **Next**.

6. The Bluetooth radio tries to connect with the device.



7. If you created a passcode, you will be prompted by the other device to enter the same passcode. Enter the created passcode to establish a paired connection.

If you entered a device specific passcode, you should not have to do anything on the other device.

8. When the connection is complete, a list of matching and supported services on the device appears. Only the services that are mutually supported on both devices appear in the Partnership Settings window.

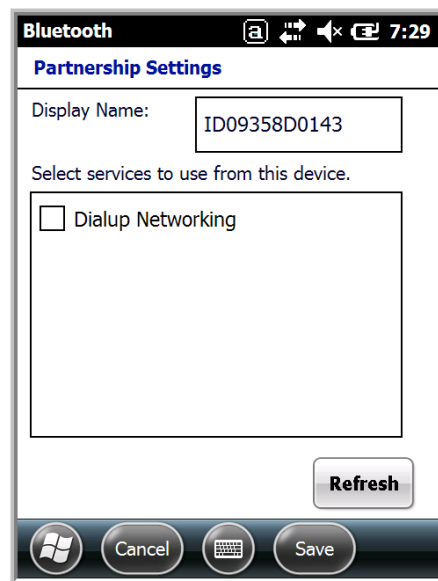

9. Select the services you want to use and tap **Save**.

The services on the new devices have to be selected or the pairing won't include those services, even though the devices are paired. If services are not selected, you will be continually re-prompted for the passcode from the device.

10. The device appears in the list on the main window.

If you are connecting to a printer or headset, complete any additional steps required by device.



11. After the passcodes have been accepted on both sides, you have a trusted (paired) connection.

Transferring Files

1. Tap  > **File Explorer**.
2. Navigate to the file you want to transfer.
3. Tap and hold on the file and select **Beam File** on the popup menu.

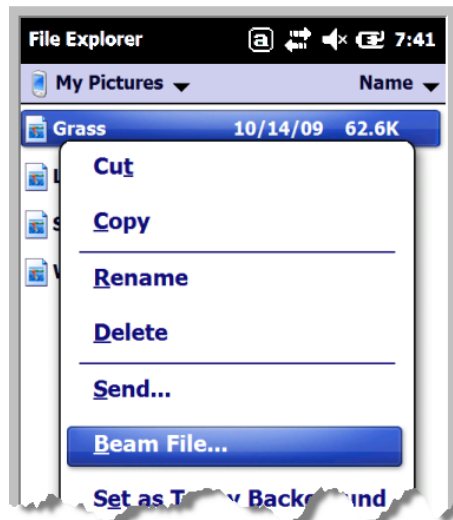

- The Bluetooth radio begins searching for devices.

When a Bluetooth device is first found, it appears as an Unknown device; the  icon indicates that the device is a Bluetooth device.

As data is retrieved, the device IDs appear in the list.

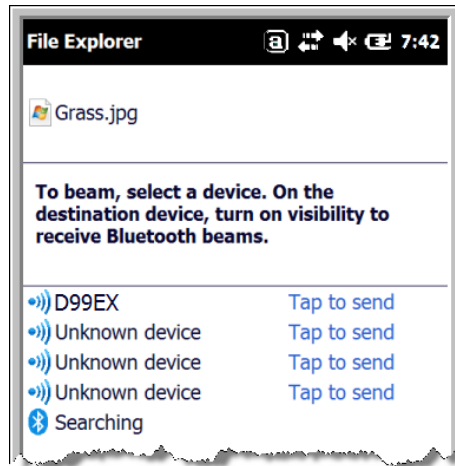

- Tap the device to begin sending the selected file.
- While trying to connect, the selected device reads "Pending".

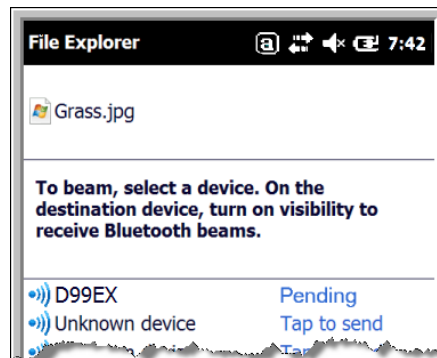

- When the file is being transferred, the selected device reads "Sending".

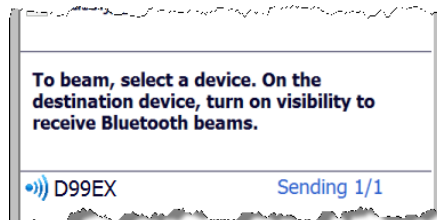

Making the Terminal Discoverable

By default, the Dolphin terminal is not discoverable, which means that the terminal will not be found by other Bluetooth devices.

- To make the terminal discoverable, tap **Mode** on the Horizontal scroll.

2. Select **Make this device visible to other devices** and tap **OK**.

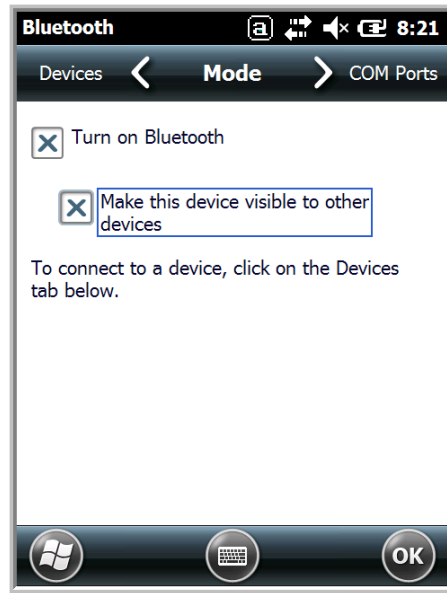

Selecting COM Ports

You can select COM ports 0-9. For more information, [COM Port Assignment Table](#), page 8-7.

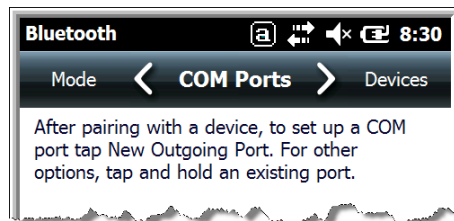

Working with GPS

Overview

The Dolphin 6000 terminal contains an integrated GPS module that allows location tracking of workers and vehicles, providing better utilization of field assets. Optional mapping and navigation software provides turn-by-turn driving directions and location information.

Assisted GPS Support

The operating system software supports assisted GPS mode, which usually requires installing a vendor-specific client on the device that communicates with the GPS module.

Communication Ports

Selecting the Port

1. Tap  > **Settings** -> **System** -> **External GPS**.
2. Tap the **GPS program port** box. A drop-down list opens.
3. In the GPS program port drop-down list, choose the **COM** or **GPD** port (the default is GPD1) as needed by the application.

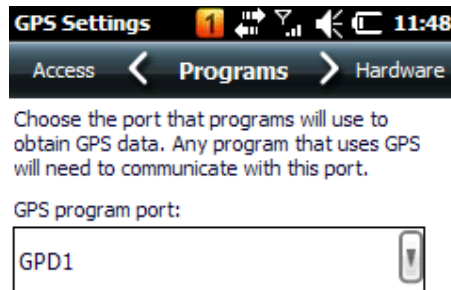

4. Tap **OK** to save.

Baud Rate

- The default baud rate is 38400.

GPS Intermediate Driver

When the first user of GPD1 opens the port, the GPS Intermediate Driver opens port COM1. The GPS Intermediate Driver lets multiple applications open GPD1, and GPS data is transmitted to all open ports.

Note: For more information about Microsoft's GPS Intermediate Driver, refer to: <http://msdn.microsoft.com/en-us/library/ms850332.aspx>.



Dolphin 6000 HomeBase

Overview

The Dolphin 6000 HomeBase supports both RS232 and USB communications, which makes it able to connect with majority of PC-based enterprise systems.

Capacity

The HomeBase holds one Dolphin 6000 terminal and has an auxiliary battery well behind the terminal well. The HomeBase can charge two battery packs:

- Battery installed in Dolphin 6000 terminal
- Spare battery in auxiliary battery well



We recommend use of Honeywell Li-Ion battery packs. Use of any non-Honeywell battery may result in damage not covered by the warranty.



We recommend use of Honeywell peripherals, power cables, and power adapters. Use of any non-Honeywell peripherals, cables, or power adapters may cause damage not covered by the warranty.

Charge Time

The HomeBase completes a full charge of a battery pack installed in the terminal well in 4 hours. The HomeBase completes a full charge of a battery pack in Auxiliary Battery Well in 4 hours (see [Auxiliary Battery Well](#) on page 12-3).

Charging Process

Note: The HomeBase does not support charging through the USB cable. The HomeBase can only charge from the standard wall outlet power adapter.

The HomeBase gives power to the intelligent battery charging system in the Dolphin 6000 terminal. The charging systems know when a full charge of the battery has been completed and switches to a trickle charge to keep a full charge of the battery.

Communications

Satisfactory data communications at speeds of up to 115k baud can be transmitted by the HomeBase through the RS232 serial port. The maximum UBSB communication is 480 Mbps.

Parts and Functions

Front Panel

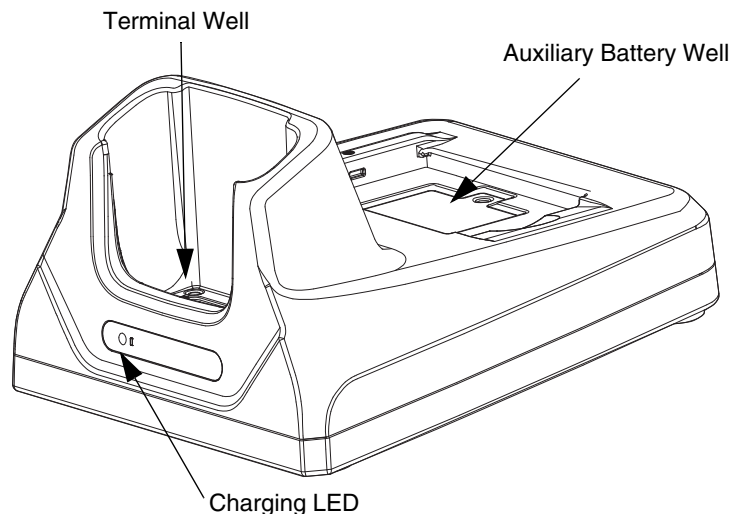

Terminal Well

Place the Dolphin 6000 in the terminal well to use the terminal and to charge a battery pack in the terminal. The HomeBase charges the battery in 4 hours. If the host terminal is a workstation that uses ActiveSync, synchronization begins immediately.

AUX Battery Status LED

The AUX battery status LED shows the status of battery charging in auxiliary battery well; see [Back Panel](#) on page 12-3.

Status	LED color
Pre-charge (for a very low battery)	Orange
Fast Charge	Red
Full (completed charge)	Green
Battery cannot be charged	Orange Blinking
No Battery	Off
Fault or Over Temperature	Off

Note: For information about charging a battery in auxiliary battery well, see [Charging a Battery in the Auxiliary Battery Well](#) on page 12-5.

Back Panel

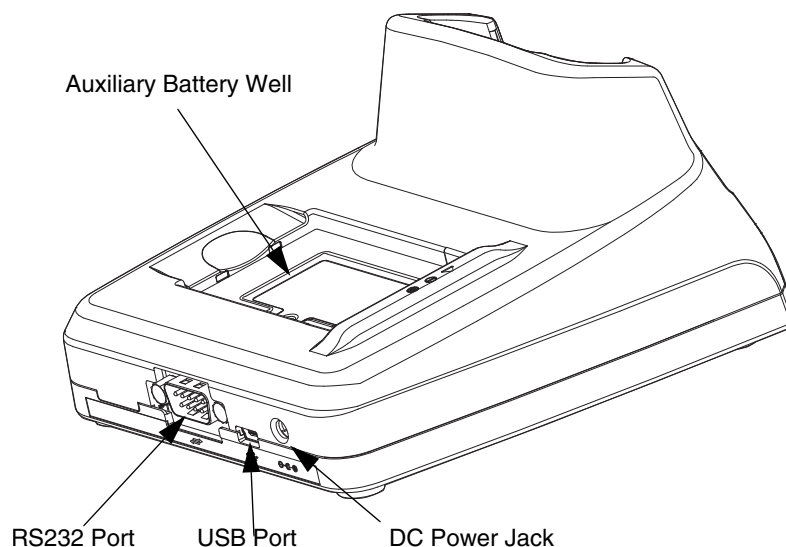

Auxiliary Battery Well

The HomeBase can charge an additional Li-ion battery pack in 4 hours in the well behind the terminal. This feature ensures that you can always have an additional fully-charged battery for Dolphin 6000 terminal. See [Charging a Battery in the Auxiliary Battery Well](#) on page 12-5.

USB Port

This USB Port is full-speed and 2.0 compliant. Using a USB cable, you can connect the base to a peripheral device, such as a workstation. When the terminal is seated in the terminal well, it is connected to the workstation device via the base.

RS232 Port

Use the 9-pin, RS232 cable from Honeywell to connect this port to a peripheral device for RS232 data communication. For more information, see [Serial Connector](#) on page 12-3.

DC Power Jack

Use the power cable from Honeywell that comes with HomeBase to supply power to this power jack. For more information, see the [Power](#) on page 12-3 section that follows.

Power

The terminal requires 5V, 2A DC input for communications and battery charging; the power adapter on power cable converts voltage from the power source to 5V, 2A DC. Only the Honeywell 5 VDC, 2A power supply provided with the HomeBase converts the voltage correctly.

It is recommended that the HomeBase be left connected to its power source at all times, so that it is always ready to use.

1. Connect adaptor barrel plug to DC jack on rear panel of HomeBase
2. Plug adaptor AC to the indoor wall receptacle.

Serial Connector

The following diagram shows pin diagram of serial connector of HomeBase.

Pin	Description
1	N/C
2	TXD
3	RXD
4	DSR
5	GND
6	N/C
7	CTS
8	RTS
9	N/C

Note: Signals referenced are for a DTE device. The HomeBase is at a right-angle to the printed circuit board (PCB).

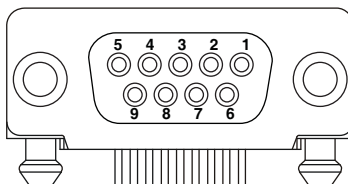

Charging the Battery

The HomeBase powers the terminal and charges its battery pack in 4 hours.

The cradle knows when battery pack is fully charged and automatically changes to a trickle charge that keeps the battery at full capacity. The terminal can stay in the HomeBase without damaging the terminal or battery packs.

Note: To check battery power, use Power menu setting; see [Power](#) on page 7-13.
For more information about Li-ion batteries, see [Battery Pack](#) on page 3-10.

To Power a Terminal and Charge its Battery

1. Install the battery pack in the terminal. Refer to [Installing Battery Pack](#) on page 2-1.
2. Connect the HomeBase to a power supply provided by Honeywell.
3. Put the terminal into the terminal well until the LED on the terminal turns red, indicating that it is charging. The battery pack begins to charge.



Ensure all components are dry prior to mating terminals/batteries with peripheral devices. Mating wet components may cause damage not covered by the warranty.

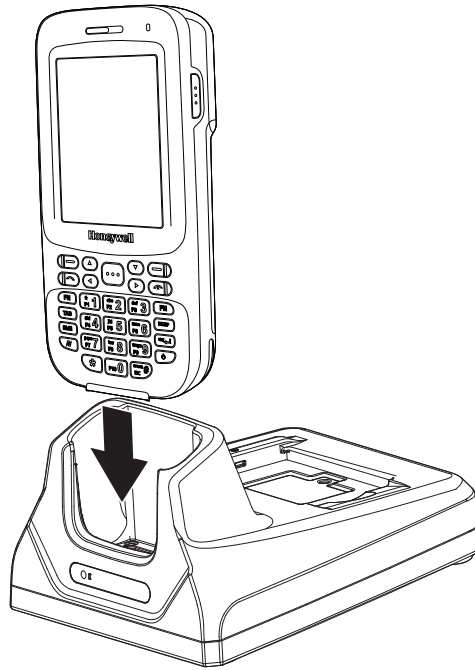

Charging a Battery in the Auxiliary Battery Well

The auxiliary battery well located on the back of the HomeBase charges a spare battery independently of the terminal well. The Auxiliary Battery LED on the front panel shows the status of the battery in this well.

Complete charge time is 4 hours.

1. Insert the end of battery into the auxiliary well opening by lining up the connectors. The Auxiliary Battery LED turns red.
2. See [AUX Battery Status LED](#) on page 12-2 to monitor charging progress.

Communication

USB

Dolphin 6000 terminals support USB communications.

The HomeBase also supports USB communications via the USB port located on the back of HomeBase. The base acts as a USB device by interfacing the USB signals of the Dolphin 6000 terminal to the USB of the host workstation. Using a standard USB Communication Cable, the HomeBase's USB interface allows the Dolphin 6000 terminal to communicate with a workstation.

RS232

The HomeBase supports RS232 communications via the RS232 Communications Port located on back of HomeBase. This port enables the Dolphin 6000 terminal to communicate to a workstation, modem, or any RS232 device using a standard serial cable and communications software.

Requirements

- A HomeBase powered by a power cable and power adapter cable
- For RS232 communications, use a serial cable
- For USB communications, use a USB Communication Cable
- For USB communications, use ActiveSync v4.5 or above on the host workstation
- Windows® XP 2003 Server, Windows Vista, or Windows 7 on the host workstation.

Connecting the Communication Cables

1. Plug in the power supply and connect it to the back of the HomeBase.
2. Plug the USB or RS232 communication cable into back of the HomeBase.
3. Connect the communication cable into the back of the workstation.

Note: At this point, the hardware is installed and operating. For USB communication, the workstation may need to be rebooted to complete the installation process.

Establishing Communication

USB Communication

An ActiveSync connection should be auto-detected and configured when the USB connection is established.

Note: ActiveSync 4.5 or higher must be used.

RS232 communication

The RS232 port is accessed by opening COM3 on the terminal and can be used for general purpose communication between an application running on the Dolphin 6000 and an application on a PC or a connected device.

Note: An ActiveSync connection cannot be established via RS232.

Customer Support

Technical Assistance

If you need assistance installing or troubleshooting your device, please contact us by using one of the methods below:

Knowledge Base: www.hsmknowledgebase.com

Our Knowledge Base provides thousands of immediate solutions. If the Knowledge Base cannot help, our Technical Support Portal (see below) provides an easy way to report your problem or ask your question.

Technical Support Portal: www.hsmsupportportal.com

The Technical Support Portal not only allows you to report your problem, but it also provides immediate solutions to your technical issues by searching our Knowledge Base. With the Portal, you can submit and track your questions online and send and receive attachments.

Web form: www.hsmcontactsupport.com

You can contact our technical support team directly by filling out our online support form. Enter your contact details and the description of the question/problem.

Telephone: www.honeywellaidc.com/locations

For our latest contact information, please check our website at the link above.

Product Service and Repair

Honeywell International Inc. provides service for all its products through service centers throughout the world. To obtain warranty or non-warranty service, contact the appropriate location below to obtain a Return Material Authorization number (RMA #) before returning the product.

North America

Telephone: (800) 782-4263
E-mail: hsmnaservice@honeywell.com

Latin America

Telephone: (803) 835-8000
Telephone: (800) 782-4263
Fax: (239) 263-9689
E-mail: laservice@honeywell.com

Brazil

Telephone: +55 (11) 5185-8222
Fax: +55 (11) 5185-8225
E-mail: brservice@honeywell.com

Mexico

Telephone: 01-800-HONEYWELL (01-800-466-3993)
Fax: +52 (55) 5531-3672
E-mail: mxservice@honeywell.com

Europe, Middle East, and Africa

Telephone: +31 (0) 40 2901 633
Fax: +31 (0) 40 2901 631
E-mail: euroservice@honeywell.com

Hong Kong

Telephone: +852-29536436
Fax: +852-2511-3557
E-mail: apservice@honeywell.com

Singapore

Telephone: +65-6842-7155
Fax: +65-6842-7166
E-mail: apservice@honeywell.com

China

Telephone: +86 800 828 2803
Fax: +86-512-6762-2560
E-mail: apservice@honeywell.com

Japan

Telephone: +81-3-6730-7344
Fax: +81-3-6730-7222
E-mail: apservice@honeywell.com

Online Product Service and Repair Assistance

You can also access product service and repair assistance online at www.honeywellaidc.com.

Limited Warranty

Honeywell International Inc. ("HII") warrants its products and optional accessories to be free from defects in materials and workmanship and to conform to HII's published specifications applicable to the products purchased at the time of shipment. This warranty does not cover any HII product which is (i) improperly installed or used; (ii) damaged by accident or negligence, including failure to follow the proper maintenance, service, and cleaning schedule; or (iii) damaged as a result of (A) modification or alteration by the purchaser or other party, (B) excessive voltage or current supplied to or drawn from the interface connections, (C) static electricity or electro-static discharge, (D) operation under conditions beyond the specified operating parameters, or (E) repair or service of the product by anyone other than HII or its authorized representatives.

This warranty shall extend from the time of shipment for the duration published by HII for the product at the time of purchase ("Warranty Period"). Any defective product must be returned (at purchaser's expense) during the Warranty Period to HII factory or authorized service center for inspection. No product will be accepted by HII without a Return Materials Authorization, which may be obtained by contacting HII. In the event that the product is returned to HII or its authorized service center within the Warranty Period and HII determines to its satisfaction that the product is defective due to defects in materials or workmanship, HII, at its sole option, will either repair or replace the product without charge, except for return shipping to HII.

EXCEPT AS MAY BE OTHERWISE PROVIDED BY APPLICABLE LAW, THE FOREGOING WARRANTY IS IN LIEU OF ALL OTHER COVENANTS OR WARRANTIES, EITHER EXPRESSED OR IMPLIED, ORAL OR WRITTEN, INCLUDING, WITHOUT LIMITATION, ANY IMPLIED WARRANTIES OF MERCHANTABILITY OR FITNESS FOR A PARTICULAR PURPOSE, OR NON-INFRINGEMENT.

HII'S RESPONSIBILITY AND PURCHASER'S EXCLUSIVE REMEDY UNDER THIS WARRANTY IS LIMITED TO THE REPAIR OR REPLACEMENT OF THE DEFECTIVE PRODUCT WITH NEW OR REFURBISHED PARTS. IN NO EVENT SHALL HII BE LIABLE FOR INDIRECT, INCIDENTAL, OR CONSEQUENTIAL DAMAGES, AND, IN NO EVENT, SHALL ANY LIABILITY OF HII ARISING IN

CONNECTION WITH ANY PRODUCT SOLD HEREUNDER (WHETHER SUCH LIABILITY ARISES FROM A CLAIM BASED ON CONTRACT, WARRANTY, TORT, OR OTHERWISE) EXCEED THE ACTUAL AMOUNT PAID TO HII FOR THE PRODUCT. THESE LIMITATIONS ON LIABILITY SHALL REMAIN IN FULL FORCE AND EFFECT EVEN WHEN HII MAY HAVE BEEN ADVISED OF THE POSSIBILITY OF SUCH INJURIES, LOSSES, OR DAMAGES. SOME STATES, PROVINCES, OR COUNTRIES DO NOT ALLOW THE EXCLUSION OR LIMITATIONS OF INCIDENTAL OR CONSEQUENTIAL DAMAGES, SO THE ABOVE LIMITATION OR EXCLUSION MAY NOT APPLY TO YOU.

All provisions of this Limited Warranty are separate and severable, which means that if any provision is held invalid and unenforceable, such determination shall not affect the validity of enforceability of the other provisions hereof. Use of any peripherals not provided by the manufacturer may result in damage not covered by this warranty. This includes but is not limited to: cables, power supplies, cradles, and docking stations. HII extends these warranties only to the first end-users of the products. These warranties are non-transferable.

The limited duration of the warranty for the Dolphin 6000 is as follows:

- The duration of the limited warranty for terminals with an integrated laser engine is one year.
- The duration of the limited warranty for touch screens is one year.
- The duration of the limited warranty for the Dolphin 6000 HomeBase device is one year.
- The duration of the limited warranty for batteries is one year. Use of any battery from a source other than Honeywell may result in damage not covered by the warranty. Batteries returned to Honeywell International Inc. in a reduced state may or not be replaced under this warranty. Battery life will be greatly increased when following the battery instructions in this user's guide.





Honeywell Scanning & Mobility
9680 Old Bailes Road
Fort Mill, SC 29707

www.honeywellaidc.com