

Dolphin™ 75e

powered by Android 4.4

User's Guide

Disclaimer

Honeywell International Inc. (“HII”) reserves the right to make changes in specifications and other information contained in this document without prior notice, and the reader should in all cases consult HII to determine whether any such changes have been made. The information in this publication does not represent a commitment on the part of HII.

HII shall not be liable for technical or editorial errors or omissions contained herein; nor for incidental or consequential damages resulting from the furnishing, performance, or use of this material. HII disclaims any and all responsibility and liability for the selection and use of software and/or hardware to achieve intended results.

This document contains proprietary information that is protected by copyright. All rights are reserved. No part of this document may be photocopied, reproduced, or translated into another language without the prior written consent of HII.

Web Address: www.honeywellaidc.com

Trademarks

Android, Google, and other marks are trademarks of Google Inc.

Microsoft, Windows are either registered trademarks or registered trademarks of Microsoft Corporation in the United States and/or other countries.

The Bluetooth trademarks are owned by Bluetooth SIG, Inc., U.S.A. and licensed to Honeywell.

MIFARE Classic is a registered Trademark of NXP B.V.

Other product names mentioned in this manual may be trademarks or registered trademarks of their respective companies and are the property of their respective owners.

Patents

For patent information, see www.hsmpats.com.

Copyright © 2015 Honeywell International Inc. All rights reserved.



Table of Contents

Customer Support

| | |
|---|----|
| Product Service and Repair | ix |
| Contacting Customer Support | ix |
| Limited Warranty | ix |
| Warranty Disclaimer: Proper Use of a Touch Screen Mobile Device | ix |
| How to Extend Your Warranty | ix |

Chapter 1 - Getting Started

| | |
|---|------|
| Out of the Box | 1-1 |
| Memory Card Specifications | 1-1 |
| Initial Setup for Dolphin 75e Terminal | 1-1 |
| Customizing Home and Accessing Apps | 1-6 |
| Accessing the Notification Panel from the Status Bar | 1-7 |
| Common Status and Notification Icons | 1-7 |
| Search Bar | 1-8 |
| Personalizing the Home Screen Panels and Favorites Tray | 1-9 |
| Navigation/Function Buttons | 1-9 |
| Remap a Button Function | 1-10 |
| Virtual Keyboard | 1-10 |
| Using the Virtual Keyboard | 1-10 |
| Turning Power On/Off | 1-10 |
| Turning Sleep Mode (Suspend Mode) On/Off | 1-10 |
| Turning Airplane Mode On/Off | 1-11 |
| Replacing the Battery | 1-11 |
| Restarting the Terminal | 1-12 |
| Entering Safe Mode for Troubleshooting | 1-12 |
| Resetting the Terminal | 1-13 |
| Connecting the Terminal to a Computer (PC) via a USB Connection | 1-13 |
| Using the File Browser Power Tool on the Terminal | 1-14 |
| Enabling or Disabling File Auto Install | 1-14 |
| Installing Upgrades | 1-15 |

Chapter 2 - Hardware Overview

| | |
|---|-----|
| Standard Configuration for the Dolphin 75e | 2-1 |
| Peripherals for the Dolphin 75e | 2-1 |
| Accessories for the Dolphin 75e | 2-2 |
| Holsters (Model HOLSTER-2 and 6000-HOLSTER) | 2-2 |
| Wrist Lanyard (Model SL-LANYARD-1) | 2-2 |
| Stylus (Model 75e-Stylus) | 2-2 |
| Battery Door Kits | 2-2 |
| Battery (Models 70e-BTSC and 70e-BTEC) | 2-2 |
| Features of the Dolphin 75e | 2-3 |
| Front, Bottom, and Right Panels | 2-3 |
| Back, Top, and Left Panels | 2-6 |
| The I/O Connector | 2-8 |

| | |
|---|------|
| Battery | 2-9 |
| Replacement Battery Specifications | 2-9 |
| Invalid Battery Error Message | 2-9 |
| Charging Options..... | 2-9 |
| Charging Times | 2-9 |
| Understanding and Changing the Battery Charge Status LED Indicator..... | 2-10 |
| Important Charging Guidelines | 2-10 |
| Checking the Battery Health..... | 2-11 |
| Managing Battery Power | 2-11 |
| Storing Batteries | 2-12 |
| Guidelines for Battery Pack Use and Disposal..... | 2-12 |
| System Resets | 2-12 |
| Hardware Maintenance | 2-12 |
| Installing a Memory Card or NFC SIM Card..... | 2-12 |
| Installation and/or Replacement | 2-13 |

Chapter 3 - Using the Scan Image Engine

| | |
|---|------|
| Overview..... | 3-1 |
| Image Engine Specifications | 3-1 |
| Field of View | 3-1 |
| Depth of Field | 3-1 |
| Supported Bar Code Symbologies | 3-2 |
| Decoding | 3-2 |
| Scan Wedging | 3-2 |
| Changing the Scan Settings of the Default Profile..... | 3-3 |
| Adding a Scanning Profile | 3-6 |
| Using the Scan Demo to Decode a Bar Code | 3-6 |
| Configuring the Scan Demo Application | 3-7 |
| Using the Demo to Save a Picture for Troubleshooting..... | 3-8 |
| Aiming Beam | 3-8 |
| Capturing Images | 3-8 |
| Using the IQ Image Demo to decode intelligent bar codes and capture images..... | 3-9 |
| Using the Signature Demo..... | 3-10 |
| Uploading Images..... | 3-10 |

Chapter 4 - Using the Color Camera

| | |
|---|-----|
| Overview..... | 4-1 |
| Opening the Camera app and Adjusting the Settings | 4-1 |
| Adjusting the Camera/Video Settings | 4-1 |
| Taking a Photo | 4-1 |
| Taking a Panoramic Photo | 4-2 |
| Uploading Pictures and Videos | 4-3 |

Chapter 5 - Settings

| | |
|-----------------------------------|-----|
| Overview..... | 5-1 |
| Wireless & Network Settings | 5-1 |

| | |
|--|-----|
| Device Settings..... | 5-1 |
| Changing the Sound Settings..... | 5-1 |
| Changing the Display Settings..... | 5-2 |
| Viewing Storage Statistics..... | 5-2 |
| Changing the Battery Settings..... | 5-2 |
| Managing Apps..... | 5-3 |
| Personal Settings..... | 5-3 |
| Enabling or Disabling Location Service..... | 5-3 |
| Managing Security..... | 5-4 |
| Language & input..... | 5-5 |
| Changing the Display Language..... | 5-5 |
| Activating Spell Check..... | 5-5 |
| Managing the Personal Dictionary..... | 5-5 |
| Changing the Keyboard & Input Methods..... | 5-5 |
| Customizing the Optional Enhanced Keyboard..... | 5-6 |
| Adjusting the Sensitivity and Speed of the Touch Panel Response..... | 5-7 |
| Backup & reset..... | 5-7 |
| Honeywell Settings..... | 5-7 |
| Key Remapping..... | 5-7 |
| Modifying the Smart Sensors..... | 5-7 |
| Changing the Battery LED Functionality..... | 5-7 |
| Viewing the Battery Health..... | 5-7 |
| Activating the Logger..... | 5-7 |
| Scanning..... | 5-8 |
| Web applications..... | 5-8 |
| Accounts..... | 5-8 |
| Adding or Modifying an IMAP or Corporate Exchange Account..... | 5-8 |
| System..... | 5-8 |
| Setting the Date & Time..... | 5-8 |
| Customizing Services and System Features for Accessibility..... | 5-9 |
| Enabling Developer Options..... | 5-9 |
| About Phone..... | 5-9 |

Chapter 6 - Communication

| | |
|--|-----|
| Wireless & Networks Settings..... | 6-1 |
| Connecting the Terminal to a Wireless Network..... | 6-1 |
| Wi-Fi Network Connections..... | 6-2 |
| Turning Wi-Fi Networking On or Off..... | 6-2 |
| Connecting to a Wi-Fi Network..... | 6-2 |
| Receiving Network Notifications..... | 6-2 |
| Adding a Wi-Fi Network..... | 6-2 |
| Advanced Wi-Fi Settings and Network Utilities..... | 6-3 |
| Advanced Wi-Fi Menu..... | 6-3 |
| Wi-Fi Radio Settings Power Tool..... | 6-3 |
| Modifying Station Mode and AP Mode Configurations..... | 6-3 |
| Viewing General Wi-Fi Info..... | 6-3 |
| Airplane Mode..... | 6-4 |

| | |
|--|-----|
| Virtual Private Networks (VPN) | 6-4 |
| Adding a VPN Profile | 6-4 |
| Connecting to a VPN | 6-4 |
| Disconnecting from a VPN..... | 6-4 |
| Editing or Deleting a VPN Profile..... | 6-4 |
| Working with Certificates | 6-5 |
| Installing a Certificate | 6-5 |
| Viewing, Disabling, or Removing Certificates | 6-5 |
| Ethernet Communication | 6-6 |

Chapter 7 - Working with Bluetooth and NFC Technology

| | |
|---|-----|
| Bluetooth Technology | 7-1 |
| Turning the Bluetooth Radio On or Off | 7-1 |
| Pairing and Trusted Devices..... | 7-1 |
| Connecting to Other Bluetooth Devices..... | 7-1 |
| Configuring or Unpairing Bluetooth Devices..... | 7-1 |
| Making the Terminal Discoverable | 7-1 |
| Bluetooth Menu Options | 7-2 |
| Sharing Pictures and Video | 7-2 |
| Near Field Communication (NFC) Technology..... | 7-3 |
| Hardware Requirements..... | 7-3 |
| Security Recommendation..... | 7-3 |
| NFC Settings | 7-3 |
| Reading NFC Tags..... | 7-4 |
| Transferring screen content via NFC..... | 7-4 |
| Using the NFC Demos..... | 7-4 |

Chapter 8 - Dolphin 70e Black HomeBase (Model 70e-HB)

| | |
|--|-----|
| Overview..... | 8-1 |
| Unpacking the HomeBase..... | 8-1 |
| Optional Equipment | 8-1 |
| Charging Overview | 8-1 |
| Convenient Storage | 8-1 |
| Capacity..... | 8-2 |
| Dimensions..... | 8-2 |
| Weight | 8-2 |
| Parts and Functions..... | 8-3 |
| Front Panel | 8-3 |
| Back Panel | 8-4 |
| Bottom Panel | 8-4 |
| Power | 8-4 |
| Connecting Power to the HomeBase | 8-5 |
| Charging the Main Battery..... | 8-5 |
| Charging a Spare Battery in the Auxiliary Battery Well | 8-5 |
| Communication..... | 8-6 |
| Requirements | 8-6 |
| Establishing USB Communication | 8-6 |

| | |
|-------------------------------|-----|
| Mounting the HomeBase | 8-6 |
| Optional DIN Rail Mount | 8-6 |
| Additional Hardware | 8-6 |
| Installing the DIN Rail | 8-7 |

Chapter 9 - Dolphin 70e Black eBase (Model 70e-EHB)

| | |
|--|-----|
| Overview | 9-1 |
| Unpacking the eBase | 9-1 |
| Optional Equipment | 9-1 |
| Charging Overview | 9-1 |
| Convenient Storage | 9-1 |
| Capacity | 9-1 |
| Dimensions | 9-2 |
| Weight | 9-2 |
| Parts and Functions | 9-2 |
| Front Panel | 9-2 |
| Back Panel | 9-3 |
| Bottom Panel | 9-4 |
| Power | 9-4 |
| Connecting Power to the eBase | 9-5 |
| Charging the Main Battery | 9-5 |
| To Power a Terminal and Charge its Main Battery | 9-5 |
| Charging a Spare Battery in the Auxiliary Battery Well | 9-5 |
| Communication | 9-6 |
| Establishing Ethernet Communication | 9-6 |
| Establishing USB Communication | 9-7 |
| Mounting the eBase | 9-7 |

Chapter 10 - Dolphin 70e Black Mobile Base (Model 70e-MB)

| | |
|--|------|
| Overview | 10-1 |
| Charging Overview | 10-1 |
| Convenient Storage | 10-1 |
| Dimensions | 10-1 |
| Weight | 10-1 |
| Mobile Base Components | 10-2 |
| Adjustable Arm with Suction Cup Base for Windshield Mounting | 10-2 |
| Mounting the Mobile Base | 10-3 |
| Safety Precautions | 10-3 |
| Installation | 10-3 |
| Charging the Main Battery | 10-4 |
| To Power a Terminal and Charge its Main Battery | 10-5 |
| Removing the Cable | 10-6 |

Chapter 11 - Dolphin 70e Black ChargeBase (Model 70e-CB)

| | |
|--------------------------------|------|
| Overview | 11-1 |
| Unpacking the ChargeBase | 11-1 |
| Charging Overview | 11-1 |

| | |
|--|------|
| Convenient Storage | 11-1 |
| Capacity | 11-1 |
| Dimensions | 11-2 |
| Weight | 11-2 |
| Parts and Functions..... | 11-2 |
| Front Panel | 11-2 |
| Dock LEDs..... | 11-2 |
| Back Panel | 11-3 |
| Power Supply Connector..... | 11-3 |
| Bottom Panel | 11-3 |
| Power | 11-3 |
| Connecting Power to the ChargeBase | 11-4 |
| Charging the Main Battery | 11-4 |
| To Power a Terminal and Charge its Main Battery..... | 11-4 |
| Mounting the ChargeBase..... | 11-4 |
| Optional DIN Rail Mount..... | 11-5 |
| Additional Hardware | 11-5 |
| Installing the DIN Rail | 11-5 |

Chapter 12 - Dolphin 70e Black Net Base (Model 70e-NB)

| | |
|---|------|
| Unpacking the Net Base..... | 12-1 |
| Optional Equipment | 12-1 |
| Charging Overview | 12-1 |
| Convenient Storage..... | 12-1 |
| Capacity..... | 12-1 |
| Dimensions..... | 12-2 |
| Weight | 12-2 |
| Parts and Functions..... | 12-2 |
| Front Panel | 12-2 |
| Bottom Panel | 12-4 |
| Power | 12-4 |
| Connecting Power to the Net Base..... | 12-4 |
| Charging the Main Battery | 12-4 |
| To Power a Terminal and Charge the Main Battery | 12-4 |
| Communication..... | 12-5 |
| Establishing Ethernet Communication..... | 12-5 |
| Bottom Panel | 12-6 |
| Optional DIN Rail Mount..... | 12-6 |
| Additional Hardware | 12-6 |
| Installing the DIN Rail | 12-7 |

Appendix A - Dolphin 75e Terminal Agency Information

| | |
|--------------------------------------|-----|
| Label Locations | A-1 |
| Model Number and Serial Number | A-1 |
| RF Exposure Information (SAR)..... | A-1 |



Customer Support

Product Service and Repair

Honeywell International Inc. provides service for all of its products through service centers throughout the world. To find your service center, go to www.honeywellaidc.com and select **Support > Contact Support > Service and Repair**. Contact your service center to obtain a Return Material Authorization number (RMA #) before you return the product. To obtain warranty or non-warranty service, return your product to Honeywell (postage paid) with a copy of the dated purchase record.

For ongoing and future product quality improvement initiatives, the terminal comes equipped with an embedded device lifetime counter function. Honeywell may use the lifetime counter data for future statistical reliability analysis as well as ongoing quality, repair and service purposes.

Contacting Customer Support

To search our knowledge base for a solution or to log in to the Technical Support portal and report a problem, go to www.hsmcontactsupport.com.

For our latest contact information, see www.honeywellaidc.com/locations.

Limited Warranty

For warranty information, go to www.honeywellaidc.com and click **Resources > Warranty**.

The limited duration of the warranty for the Dolphin 75e is as follows:

- The duration of the limited warranty for terminals with an integrated imager is one year.
- The duration of the limited warranty for touch screens is one year.

The duration of the limited warranty for batteries is one year. Use of any battery from a source other than Honeywell may result in damage not covered by the warranty. Batteries returned to Honeywell International Inc. in a reduced state may or not be replaced under this warranty. Battery life will be greatly increased when following the battery instructions in this user's guide.

The duration of the limited warranty for the Dolphin 70e Black HomeBase, Dolphin 70e Black eBase, Dolphin 70e Black Net Base, Dolphin 70e Black Mobile Base, Dolphin 70e Black ChargeBase, and the Common QuadCharger is one year.

Warranty Disclaimer: Proper Use of a Touch Screen Mobile Device

If your device has a touch screen display, please note that a touch screen responds best to a light touch from the pad of your finger or a Honeywell approved stylus. Using excessive force or a metallic object when pressing on the touch-screen may cause damage to the tempered glass surface and may not be covered by the product's warranty.

How to Extend Your Warranty

Honeywell International Inc. offers a variety of service plans on our hardware products. These agreements offer continued coverage for your equipment after the initial warranty expires. For more information, contact your Sales Representative, Customer Account Representative, or Product Service Marketing Manager from Honeywell International Inc., or your Authorized Reseller.



Getting Started

Out of the Box

Verify that the carton contains the following items:

- Dolphin 75e handheld computer (terminal)
- 1 GB, 2 GB or 4 GB industrial grade microSD™ memory card (optional)
- Rechargeable 3.7V Li-ion battery
- USB charge/communication cable
- Power adapter with regional plug adapters
- Product documentation

If you ordered accessories for your terminal, verify that they are also included with the order. Be sure to keep the original packaging in case you need to return the Dolphin terminal for service.

Memory Card Specifications

Honeywell recommends the use of Single Level Cell (SLC) industrial grade microSD or microSDHC™ memory cards with Dolphin terminals for maximum performance and durability. Contact a Honeywell sales representative for additional information on qualified memory card options.

Initial Setup for Dolphin 75e Terminal

Step 1. Install the Battery

Before installing the main battery, read the [Guidelines for Battery Pack Use and Disposal](#) on page 2-12.

The terminal is shipped with the battery packaged separate from the unit. To install the battery, follow the installation steps illustrated. For information on how to remove the battery, see [Replacing the Battery](#) on page 1-11.



Ensure all components are dry prior to placing the battery in the terminal. Mating wet components may cause damage not covered by the warranty.

We recommend use of Honeywell Li-ion battery packs. Use of any non-Honeywell battery may result in damage not covered by the warranty.

Important: All battery and connector doors must be present, undamaged, and properly closed to maintain the environmental rating of the terminal.

Note: Standard battery and standard battery door shown.

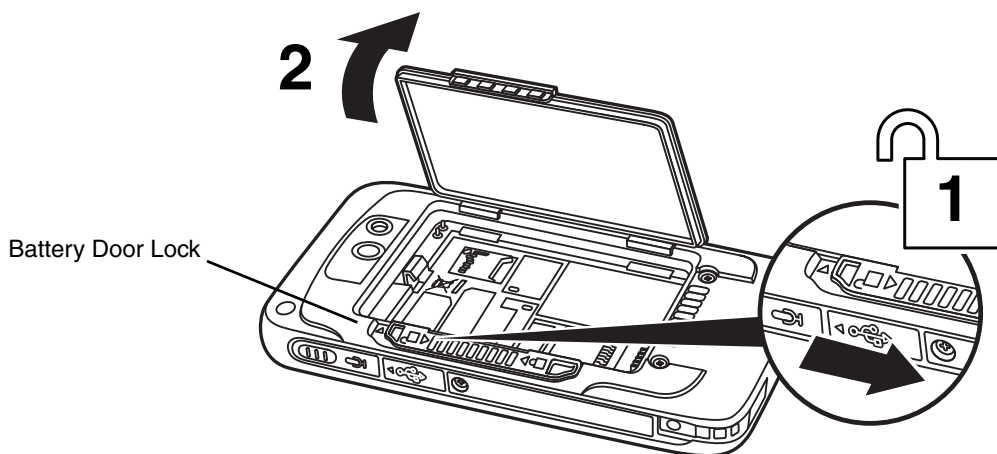

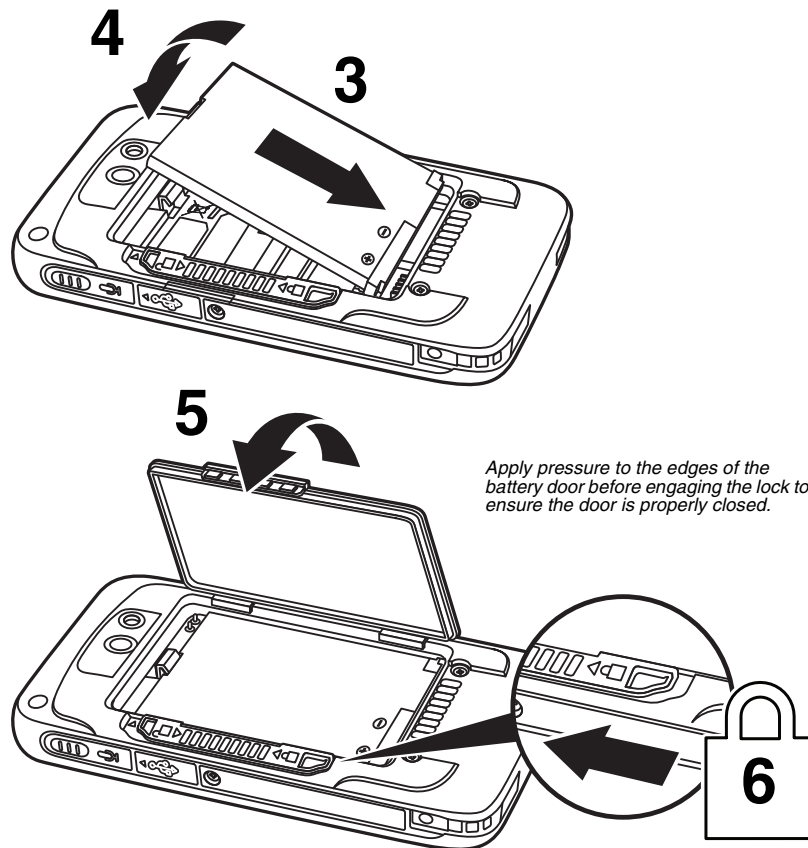

Step 2. Charge the Battery

The power source for the Dolphin terminal is the 3.7V Li-ion rechargeable battery located under the battery door on the back panel of the device. See [Battery](#) on page 2-9 for additional information on battery storage, use, and disposal.

Important: Removing the battery from the terminal erases all non-persistent memory. Always power off the terminal before removing the battery. For information on how to remove the battery from the terminal, see [Replacing the Battery](#) on page 1-11.

Before Initial Use

Dolphin terminals ship with the battery significantly discharged of power. After installing the battery in the terminal, charge the battery with a Dolphin 75e compatible charging peripheral for a minimum of **4 hours** for the standard battery pack or **6 hours** for the extended battery pack. When using the 70e-USB Charge/Communication cable to charge from a 500mA USB port on a host device, charge the battery for a minimum of **6 hours** for the standard battery and **8 hours** for the extended battery.

Note: Inadequate source current may interfere with effective battery charging; see [Important Charging Guidelines](#) on page 2-10 for additional information.



We recommend use of Honeywell peripherals, power cables, and power adapters. Use of any non-Honeywell peripherals, cables, or power adapters may cause damage not covered by the warranty.

Dolphin 75e model terminals are designed for use with the following charging devices and cables: 70e-HB, 70e-CB, 70e-EHB, 70e-NB, 70e-MB, 70e-MC, and 70e-USB ADAPTERKIT. See pages 2-1 and 2-2 for additional information on peripherals and accessories.



Ensure all components are dry prior to mating terminals/batteries with peripheral devices. Mating wet components may cause damage not covered by the warranty.

Using the USB Charge/Communication Cable (Model 70e-USB ADAPTERKIT)

Dolphin 75e terminals ship with a USB Charge/Communication Cable and a power adapter with regional plug adapters. The USB Charge/Communication cable provides two options for charging the terminal. Use the cable in conjunction with the provided power supply adapter and plug adapter to charge the terminal from a power outlet (Option 1) or connect the cable to a high-power USB port to charge from a host device (Option 2).

Warning: The terminal shall only be connected to CTIA certified adapters, products that bear the USB-IF logo or products that have completed the USB-IF compliance program when using the micro USB port as a charging source.

Option 1: Charging from a power outlet

Use only a UL Listed power supply, which has been qualified by Honeywell with an output rated at 5VDC and 1A with the device.

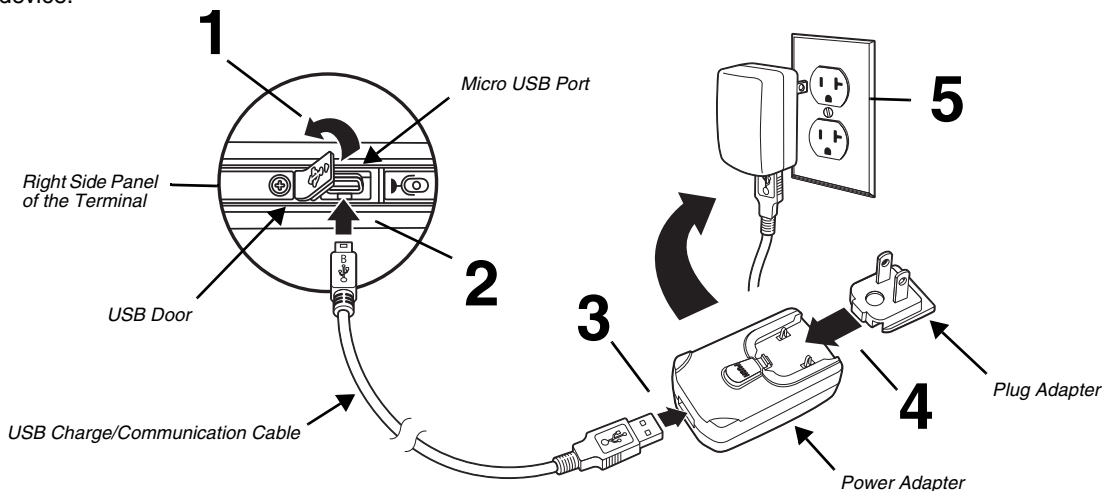

Option 2: Charging from a high power USB port on a host device (PC)

Charging the battery through a USB port takes more time than direct charging using the provided power supply. Inadequate source current may lengthen the charge time or prevent the battery from charging if the terminal is drawing more current than supplied by the USB port. The maximum current supplied by a USB Host can vary from 100mA to 500mA. **Do not attempt to charge the terminal from a 100mA source.** An active Dolphin terminal uses more current than supplied by a 100mA source causing the terminal to continue to draw power from the battery. See [Important Charging Guidelines](#) on page 2-10 for additional information.

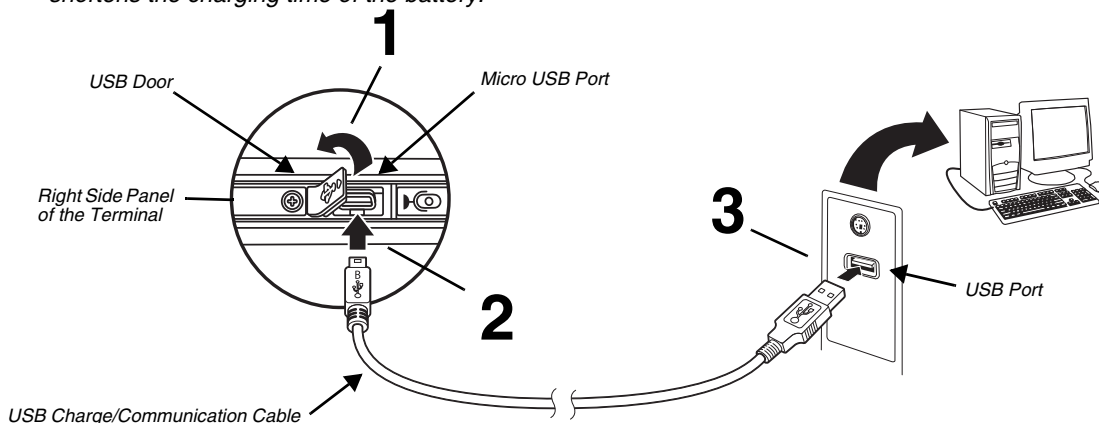

Touch **All Apps**  > **Settings**  > **Battery** to verify the battery is charging.

*Note: Placing the terminal in **Sleep (Suspend)** mode while charging reduces the current draw of the terminal and shortens the charging time of the battery.*



Step 3. Power On the Terminal and Install Update

Important: Follow the power up instructions below the **first time** you turn On the Dolphin terminal.

1. Verify the terminal is either connected to an AC power source or the battery is fully charged.
2. Press the **Power** button. When the Honeywell logo appears and the right green LED turns On, press and hold both the **Volume Up**  and **Home**  buttons at the same time.

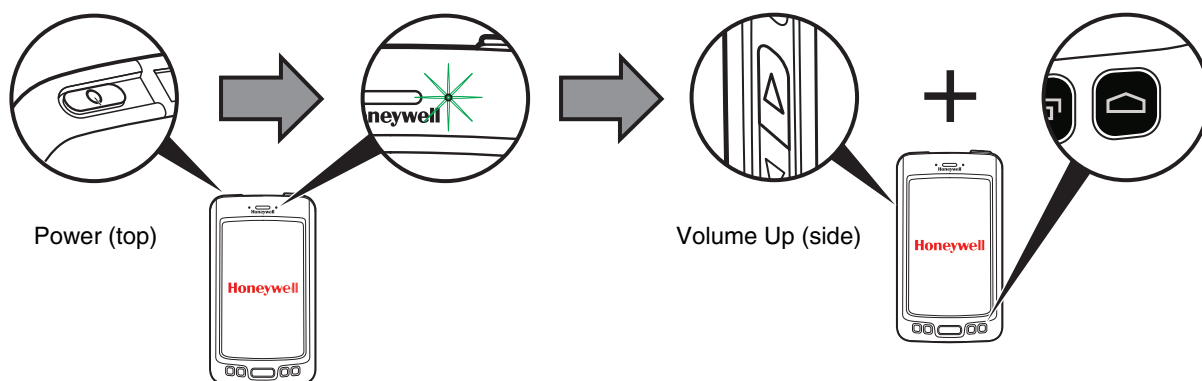

If the terminal shuts down, repeat step 2.

3. Release the buttons when the green LED turns off. After approximately 30 seconds, the system update screen appears. When the system update is finished, the lock screen appears (see page 1-5).



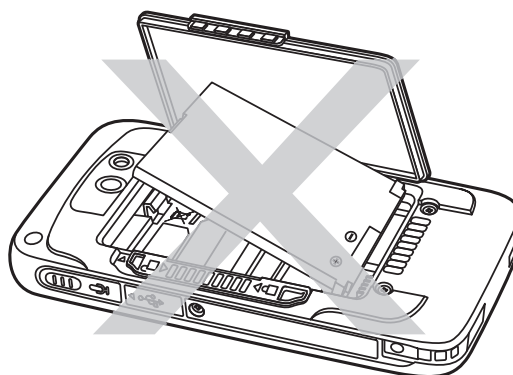

Do not remove battery during update!



Once the initial update is complete, you do not need to repeat the above steps when powering up the terminal. You can use the Power button to turn the terminal On. For more information on the power button functions, see page 1-10.

Step 4. Unlock the Screen

Drag the  to the edge of the screen or press the **Menu** button  to unlock the terminal and access the **Home** screen. For information on customizing the security feature, see [Setting up a Screen Lock](#) on page 5-4.

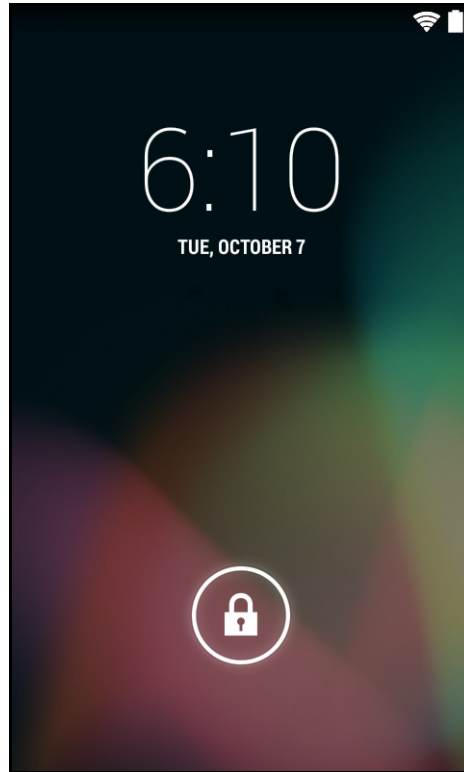

Customizing Home and Accessing Apps

Home is the first screen you see once the terminal is turned on and unlocked. Swipe left or right on the **Home** screen to scroll between five customizable panels. You can personalize the panels with your choice of shortcuts, apps, folders and widgets. The **Favorites** tray, located at the bottom of the screen, is visible from any of the five **Home** screen panels. You can modify the apps in the **Favorites** tray to include the apps you use most. To learn how, see [Personalizing the Home Screen Panels and Favorites Tray](#) on page 1-9.

If you want to view all the apps and widgets available on the terminal, touch **All Apps**  in the **Favorites** tray. From the **All Apps** screen, select either **APPS** or **WIDGETS**.

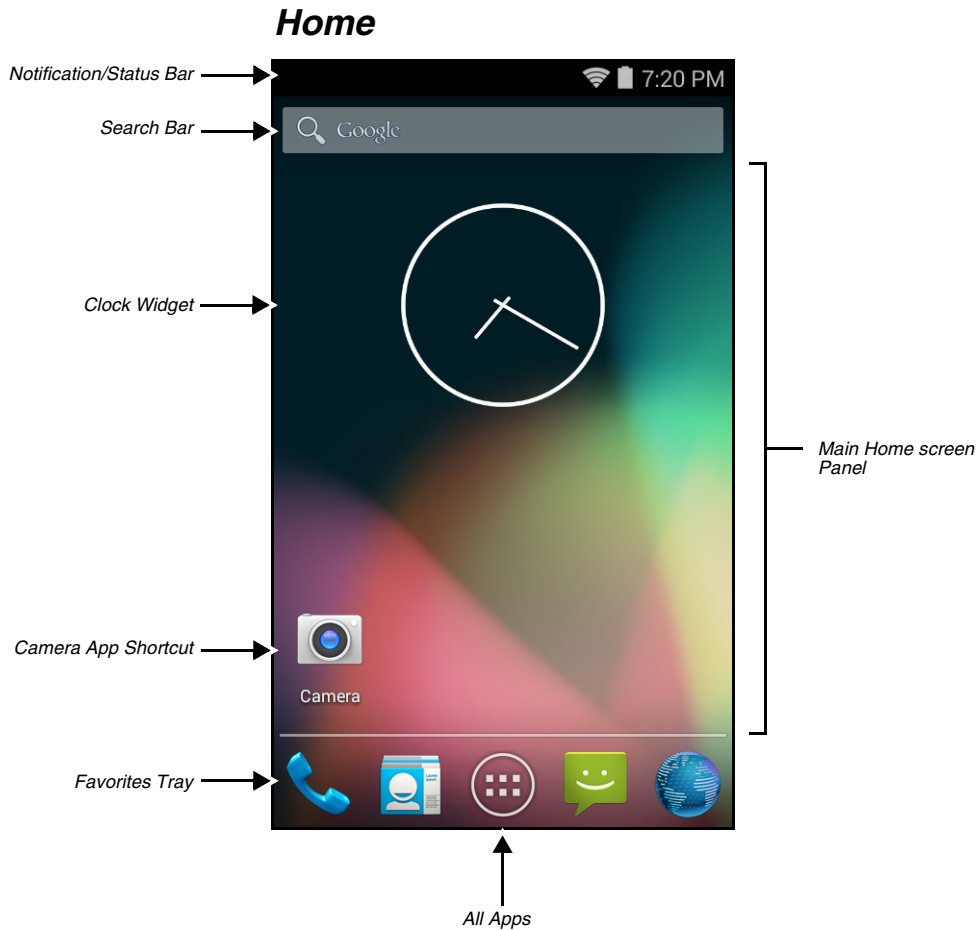

Notifications and status indicators appear at the top of the screen. Notifications appear on the left, status indicators for various system functions on the right with the current time. For information on how to view notification details, see [Accessing the Notification Panel from the Status Bar](#) on page 1-7.

You can press the **Home** button  on the front of the terminal to return to the **Home** screen from any open app.



Accessing the Notification Panel from the Status Bar

To view additional details about a notification, touch and hold the status bar at the top of the screen and then drag down. The notification panel provides quick access to all your notifications.

- Touch any notification to open the related app and access additional settings or information.
- Select  to access the quick settings screen. To return to the notifications screen, select .
- Select  to dismiss all the notifications listed. Swipe left or right on a single notification to dismiss only that notification.

To close the notification panel, swipe up from the bottom of the screen.

Notification Panel

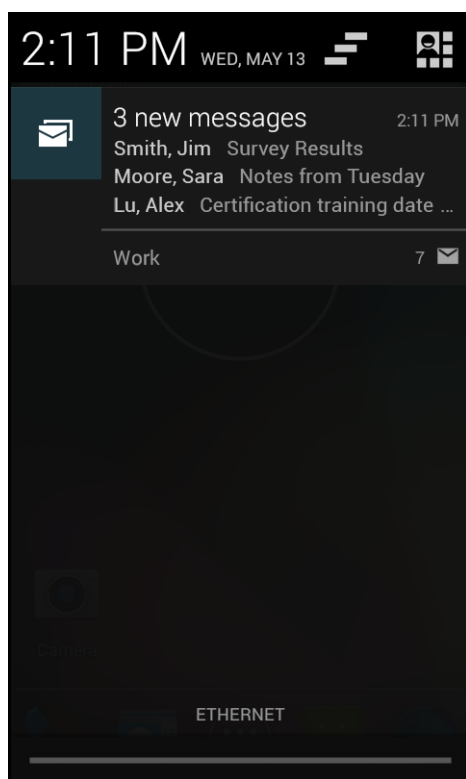

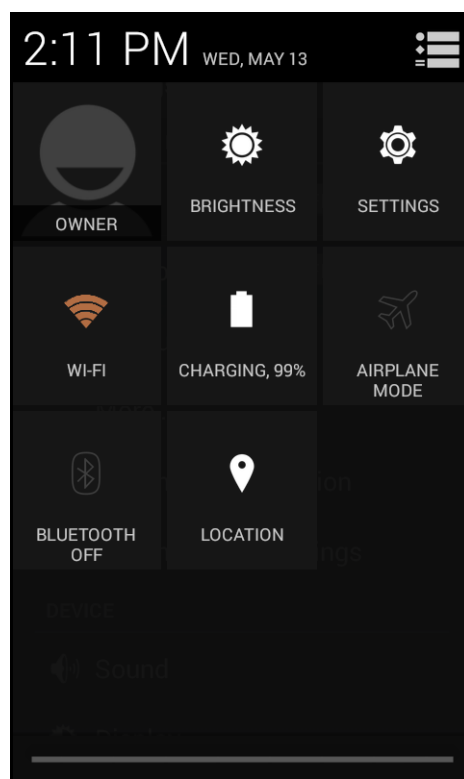

Quick Settings





























Common Status and Notification Icons

Notifications and status indicators appear at the top of the screen.

Notifications on the Left    Status and Time on the Right

| Icon | Meaning | Icon | Meaning |
|--|------------------------|---|---------------------|
| <i>Note: Notification and status icons are hardware and software dependent. Some of the icons listed below may not be relevant for your Dolphin model.</i> | | | |
|  | Pending calendar event |  | Sound is turned off |

| Icon | Meaning | Icon | Meaning |
|---|---|---|--|
|  | Pending alarm and Alarm is set |  | Vibrate mode is turned on |
|  | New text message or multimedia message |  | Battery charge is at 100% |
|  | Error with text or multimedia message delivery |  | Terminal is connected to external power and the battery is charging. |
|  | New E-mail |  | Airplane mode is turned on |
|  | Terminal is connected to a computer using a USB cable |  | Terminal paired to a device with Bluetooth technology |
|  | ABD active (USB debugging enabled) |  | Bluetooth technology is turned on |
|  | Uploading data |  | Bluetooth incoming file notification |
|  | Downloading data |  | Wi-Fi network connected with full signal strength |
|  | Download finished |  | Wi-Fi network connected but no signal strength |
|  | Synchronizing data |  | Ethernet status - disconnected |
|  | Error with sync or sign-in |  | Ethernet status - connected |
|  | The terminal could not synchronize data with the computer |  | SD card or USB storage is full |
|  | GPS is turned on | | |
|  | Receiving location data from GPS | | |

Search Bar

You can search for an item on the terminal or Internet using **Google™ Search** at the top of any **Home** screen panel. An active Internet connection is required.

Touch inside the box to access the virtual keyboard for text entry.



Personalizing the Home Screen Panels and Favorites Tray

Streamline your work flow by customizing the **Home** screen panels and **Favorites** tray with your choice of app shortcuts, folders, and widgets.

To add an app shortcut or widget:

1. Touch **All Apps** .
2. Touch **APPS** or **WIDGETS**.
3. Touch and hold the app icon or widget you want to add. The terminal vibrates, and then switches to the **Home** screen.
4. Drag and drop the app icon or widget into position on one of the panels. You can also drag the app into an open spot on the **Favorites** tray.

Hints:

- To create a folder, drag and drop an app icon on top of another icon.
- To move a shortcut from the **Favorites** tray to the **Home** screen panel, touch and hold the item, and then drag and drop the icon onto the panel.

To remove/delete an item:

1. Touch and hold the item.
2. Drag the item to the top of the screen where the word **Remove** is displayed.







To move an item:



1. Tap and hold the item.
2. When the unit vibrates, drag and drop the item in the new location.

Note: The next panel automatically opens if you drag the item to the edge of the touchscreen.

Navigation/Function Buttons

The Dolphin terminal has seven navigation/function buttons.

| Button | Function |
|---|--|
|  Back | Back to the previous screen. |
|  Menu | Opens additional menu options. |
|  | Wakes the terminal from Sleep mode (Suspend mode). |
| Scan | Triggers the scanner/imager in the following apps: IQ Image Demo and Scan Demo . Triggers the scanner/imager when scan wedging is enabled (default setting). For information on modifying the scan wedge feature see page 3-2 . |
|  Recent Apps | View and switch between recently used apps. Touch the app thumbnail to open the app or swipe the thumbnail left or right to remove it from the list. |
|  Home | Return to the Home screen. |
|  Right & Left Side | Triggers the scanner/imager in the following apps: IQ Image Demo and Scan Demo . Triggers the scanner/imager when scan wedging is enabled (default setting). For information on modifying the scan wedge feature see page 3-2 . |

| Button | Function |
|--|--|
|  Back | Back to the previous screen. |
|  Volume | Raises or lowers the volume of the active speaker. |

Remap a Button Function

You can change the default function of the **Scan**, **Left** and **Right** side buttons.

1. Touch **All Apps**  > **Settings**  > **Key remap**.
2. Select the button to remap (i.e., **LeftScan**, **RightScan**, **BottomScan**).
3. Touch **KEYS** or **APPS** to view the available functions.
4. Select the function you want assigned to the button.

For information on the button locations on the terminal, see [Features of the Dolphin 75e](#) on page 2-3.

Virtual Keyboard

The virtual keyboard appears when you open an application or select a field that requires text or numerical input. The content of the keyboard may vary depending on the application in use and the input field requirements.

Using the Virtual Keyboard

During text input, you may need to switch between keyboard modes to access additional character sets (e.g., function keys, symbols, and numbers). Each keyboard mode, includes navigation keys, which allow you to quickly switch between modes. Touch the **ABC** key to switch to the Qwerty Mode, and the **?123** key to switch to the Numeric Mode. Touch and hold the **comma** “,” key to access the settings for input options or the **period** “.” key to access additional symbols (e.g., @, %, +, &).

See [Language & input](#) on page 5-5 for additional information on configuring keyboard & input methods.

Note: The content of the keyboard and the mode initially displayed may vary depending on the application in use and the input field requirements.

Turning Power On/Off

To turn the terminal **On**, press and release the **Power** button .



To turn the terminal **Off**:

1. Press and hold the **Power** button  until the options menu displays.
2. Touch **Power Off**.

You should always power off the terminal before removing the battery. For information on removing the battery, see [Replacing the Battery](#).

Turning Sleep Mode (Suspend Mode) On/Off

Sleep mode automatically turns the touch panel display off and locks the terminal to save battery power when the terminal is inactive for a programmed period of time.



1. Press and release the **Power** button  to wake the terminal.
2. Drag the  to the edge of the display or press the **Menu** button  to unlock the terminal.

To manually place the unit in **Sleep** mode, press and release the **Power** button .

To adjust the timeout limit, touch **All Apps**  > **Settings**  > **Display** > **Sleep**.

Turning Airplane Mode On/Off

Turn **Airplane Mode** on to disable all the terminal radios that transmit voice or data.

1. Press and hold the **Power** button  until the options menu displays.
2. Touch **Airplane Mode** to toggle the mode on or off. When Airplane Mode is turned on,  shows on the status bar.

Replacing the Battery

Before replacing the battery, read the [Guidelines for Battery Pack Use and Disposal](#) on page 2-12. For battery replacement part numbers, see [Replacement Battery Specifications](#) on page 2-9.



RISK OF EXPLOSION IF BATTERY IS REPLACED BY AN INCORRECT TYPE. The battery should be disposed of by a qualified re-cycler or hazardous materials handler. Do not incinerate the battery or dispose of the battery with general waste materials.

Ensure all components are dry prior to mating terminals/batteries with peripheral devices. Mating wet components may cause damage not covered by the warranty.

We recommend use of Honeywell Li-ion battery packs. Use of any non-Honeywell battery may result in damage not covered by the warranty.

The following illustrations depict a standard battery with a standard battery door; however, battery removal and installation procedures are the same for the extended battery and extended battery door.

To replace the battery:

1. Power Off the terminal.
2. Unlock and remove the battery door.

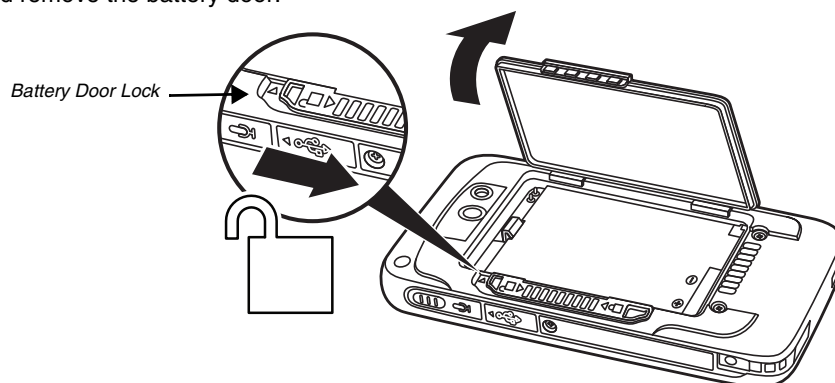

3. Pull the battery latch back and remove the battery.

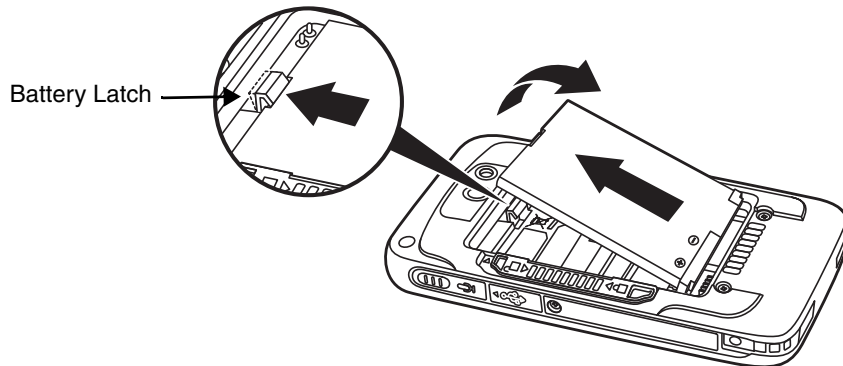

4. Insert the new battery and install the battery door.

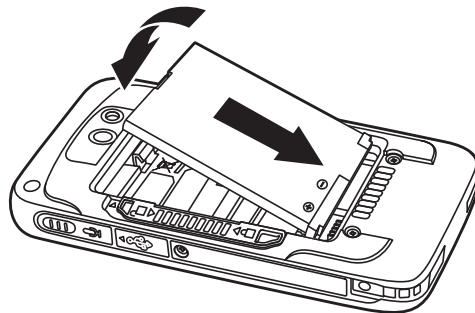

5. Apply pressure to the edges of the battery door to ensure the door is properly closed. Engage the door lock.

6. Press the **Power** button .

Important: All battery and connector doors must be present, undamaged, and properly closed to maintain the environmental rating of the terminal.

Restarting the Terminal

You may need to restart the terminal to correct conditions where an application stops responding to the system or the terminal seems to be locked up.

- Press and hold the **Power** button  until the option menu displays, and then select **Reboot**.

To perform a restart if the touch panel display is unresponsive:

- Press and hold the **Power** button  for approximately 8 seconds until the terminal starts to reboot. When the reset is complete, the **Lock** screen displays.

*Note: The Internal storage\honeywell folder on the Dolphin terminal is semi-permanent storage on the terminal. By default, files in this folder are maintained after a **Reboot**.*

Entering Safe Mode for Troubleshooting



Safe mode disables all third party applications installed on the terminal. To enter safe mode, press and hold the **Menu** button  when the unit is booting, and then select **OK** when prompted. To exit safe mode reboot the terminal.

Resetting the Terminal



If the terminal completely stops responding, you may need to perform a **Factory Reset (Clean Boot)**. Because a **Factory Reset** can result in data loss, use this method only if all other recovery methods have failed. All personal content is erased (e.g., emails, pictures, contacts) and factory default settings are restored when a factory reset is performed.



Caution: A **Factory Reset (Clean Boot)** erases the memory in the terminal, including all applications and data files, with the exception of those found in the Flash File Store or any removable storage.

1. Touch **All Apps**  > **Settings** .
2. Select **Backup & Reset**, and then **Factory Data Reset**.
3. To erase all data on the SD card in addition to all data from internal storage, check the **Erase SD card** box.
4. To erase all data in the IPSM in addition to all data from the internal storage, check the **Erase IPSM** box.
5. Select **Reset phone**.

To perform a **Factory Reset** if the touchscreen is unresponsive and all other recovery methods have failed:

1. Press and hold the **Power** button  for approximately 8 seconds until the terminal starts to reboot.
2. Press and hold the **Recent**  and **Volume Down**  buttons.

Connecting the Terminal to a Computer (PC) via a USB Connection

You can transfer files (e.g., pictures, music, and videos) between your computer and the terminal using the supplied USB Charge/Communication cable or a Dolphin 70e Black HomeBase with a standard USB cable.

Note: The terminal supports Hi-Speed USB communication (USB 2.0) with a maximum data transfer rate of 480 Mbps.

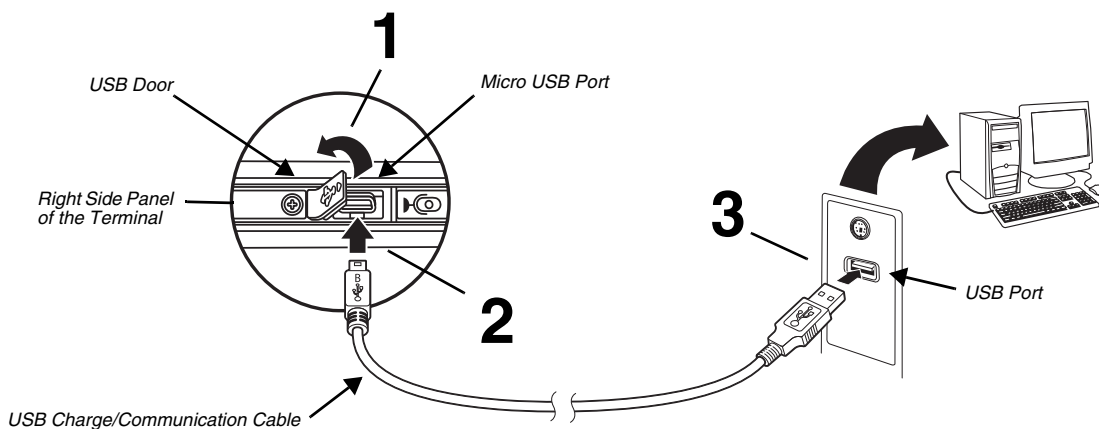

1. Connect the terminal to your PC using the USB Charge/Communication cable supplied.



2. If a USB connection automatically establishes, a notification briefly appears at the top of the screen on the terminal:

 Connected as a media device or  Connected as a camera.

If a USB connection does not automatically establish:

- a. Touch **All Apps**  > **Settings**  > **Storage**.
- b. Touch **More** , and then **USB computer connection**.
- c. Select either **Connected as a media device (MTP)** or **Camera (PTP)**. Your selection is stored as the default but is easy to change by accessing the Notification panel. Swipe down from the Status/Notification bar at the top of the screen to view USB connection details and change the type.

4. Depending on the Windows operating system either open **File Explorer** or **Windows Explorer**.

5. Under **Computer**, click on **D75E**.



6. You can now copy, delete and/or move files or folders between the computer and the terminal or the microSD card installed in the terminal as you would with any other storage drive (e.g., cut and paste or drag and drop).

Note: When you connect as a Camera (PTP) only the DCIM and Pictures Folders from the Internal Storage show in File Explorer or Windows Explorer.

The Dolphin 75e should only be connected via its microUSB connector to CTIA certified adapters, products that bear the USB-IF logo or products that have completed, the USB-IF compliance program.

Using the File Browser Power Tool on the Terminal

File Browser provides a graphical utility to browse the files stored on the terminal and the microSD card.

1. Touch **All Apps**  > **Power Tools**  > **File Browser** .
2. Touch a folder name or file name to open the folder or file.

Note: Due to system permissions, some files cannot be opened. Depending on the associated application(s), a choice of applications may be available to open the file.

Press the **Menu** button  and select **Home** to return to the root folder or **Close** to exit the File Browser.

Enabling or Disabling File Auto Install

AutoInstall is enabled by default. When **AutoInstall** is enabled, during the power up boot or reboot process, the following folders are searched for zip files containing applications.

- \Internal storage\honeywell\autoinstall on the terminal
- \IPSM card\Honeywell\Autotinstall on the terminal
- \honeywell\autoinstall on a microSD card if installed in the terminal

Each zip file found is then compared to the applications already installed on the Dolphin terminal and:

- If the application is not installed, **AutoInstall** installs the application.
- If the application is already installed, **AutoInstall** checks to see if the zip file contains a newer version of the application, and then installs the newer version.
- If the application is already installed and there is not a newer version, **AutoInstall** ignores the installation file.

When **AutoInstall** is not enabled, the contents of the Honeywell\Autoinstall folders on the terminal and on the SD card (if installed) are ignored.



To disable **AutoInstall**:

1. Touch **All Apps**  > **AutoInstall Settings** .
2. Remove the check from the **Enable AutoInstall** box to disable the option.

Installing Upgrades



Upgrades for the **Power Tools** and other system software on the Dolphin terminal come in the form of zip files and are available from [Customer Support](#) or www.honeywellaidc.com.

To install a software upgrade:



1. Copy the upgrade file (*.zip) into one of the following folders:
 - Internal storage\honeywell\autoinstall on the terminal
Software upgrades saved to this folder, do not persist when a Factory Reset (Clean Boot) is performed.
 - IPSM card\honeywell\autoinstall on the terminal
Software upgrades saved to this folder, persist when a Factory Reset (Clean Boot) is performed.
 - \honeywell\autoinstall on an SD card (if installed)
Software upgrades saved to this folder, do not persist when a Factory Reset (Clean Boot) is performed.
2. Touch **All Apps**  > **AutoInstall Settings** . Verify **Autoinstall** is enabled.
3. Select **Packages Update** from the **AutoInstall Settings**  screen. The terminal automatically initiates a reboot and installs the software upgrade.

Depending on where you saved the file, you can also initiate a software upgrade using the terminal buttons instead of the package update option.

If the file is located in the **IPSM card\honeywell\autoinstall** folder:

- Initiate a terminal **Reboot**. When the Honeywell logo appears and the green LED turns On, simultaneously press and hold the **Volume Up**  and **Home**  buttons until the green LED turns Off.

If the file is located in the **\honeywell\autoinstall** on an SD card:

- Initiate a terminal **Reboot**. When Honeywell logo appears and the green LED turns On, simultaneously press and hold the **Volume Down**  and **Home**  buttons until the green LED turns Off.



Hardware Overview

Standard Configuration for the Dolphin 75e

WLAN, WPAN, NFC & Camera

- Android 4.4
- Qualcomm APQ8074AB Processor
- 2GB RAM X 16GB Flash
- 3.7V Li-ion rechargeable standard or extended battery pack
- Dedicated imager capable of decoding standard 1D and 2D bar code symbologies
- 8.0 megapixel auto focus color camera
- 802.11a/b/g/n/ac and Bluetooth
- Near Field Communication (NFC) support

Peripherals for the Dolphin 75e

Each of the following items is sold separately to enhance the capabilities of your Dolphin terminal. Dolphin 70e Black peripherals are compatible with Dolphin 75e terminals.

Dolphin 70e Black HomeBase (Model 70e-HB)

The HomeBase is a charging and communication cradle equipped with a USB host port that is Hi-Speed 2.0v compliant, which enables the terminal to interface with the majority of PC-based enterprise systems. This device also contains an auxiliary battery well that charges a spare Honeywell standard or extended battery pack.

For more information, see [Dolphin 70e Black HomeBase \(Model 70e-HB\)](#) on page 8-1.

Dolphin 70e Black eBase (Model 70e-EHB)

The Ethernet Base (eBase) enables a single Dolphin 75e terminal to communicate with a host device over an Ethernet network. In addition, the ebase is equipped with a USB host port that is Hi-Speed 2.0v compliant, which enables the terminal to interface with the majority of PC-based enterprise systems. This device also contains an auxiliary battery well that charges a spare Honeywell standard or extended battery pack.

For more information, see [Dolphin 70e Black eBase \(Model 70e-EHB\)](#) on page 9-1.

Dolphin 70e Black Mobile Base (Model 70e-MB)

The Mobile Base is a charging cradle designed specifically for in-premise and in-transit data collection applications. It features a flexible mounting bracket, an integrated speaker with volume control, and a cigarette lighter adapter to adapt it to your mobile environment.

For more information, see [Dolphin 70e Black Mobile Base \(Model 70e-MB\)](#) on page 10-1.

Dolphin 70e Black ChargeBase (Model 70e-CB)

The ChargeBase is a 4-slot charging cradle that holds, powers, and charges terminals.

For more information, see [Dolphin 70e Black ChargeBase \(Model 70e-CB\)](#) on page 11-1.

Dolphin 70e Black Net Base (Model 70e-NB)

The Net Base enables up to four Dolphin 75e terminals to communicate with a host device over an Ethernet network. In addition, the Net Base provides a second RJ45 Ethernet port for connection to an additional device such as a printer, workstation, eBase, or another Net Base.

For more information, see [Dolphin 70e Black Net Base \(Model 70e-NB\)](#) on page 12-1.

QuadCharger (Model COMMON-QC)

The QuadCharger is a compact 4-slot battery charging station designed for use with Dolphin 75e 3.7V Li-ion rechargeable batteries. For additional information on the common QuadCharger, visit the Dolphin 75e product page at www.honeywellaidc.com or contact your local sales representative.

Accessories for the Dolphin 75e

Each of the following items is sold separately to enhance your terminal's capabilities.

Note: When using accessories where the terminal is worn on the body, the terminal's touch panel must face away from the body.

Dolphin 70e Black Mobile Charger (Model 70e-MC)

The Mobile Charger is a charging cable that connects the terminal directly to a 12 Volt DC power source, such as a cigarette lighter port inside a vehicle, eliminating the need for a cradle. Intelligent battery technology on-board the terminal ensures proper charging. The Mobile Charger is an ideal low-cost charging solution for in-transit mobile applications.

USB Charge/Communication Cable Adapter Kit (Model 70e-USB ADAPTERKIT)

The Dolphin USB charge/communication cable adapter kit is an all-in-one solution for charging and communication. Use the 70e-USB cable in conjunction with the included power supply adapter and plug adapter to charge the terminal from a power outlet or connect the cable to a high-power USB port to charge from a host device. The 70e-USB cable also supports communication with a computer without the need for a cradle. See [Connecting the Terminal to a Computer \(PC\) via a USB Connection](#) on page 1-13.

Holsters (Model HOLSTER-2 and 6000-HOLSTER)

A holster provides convenient storage for the Dolphin 75e terminal in mobile environments. Long and short holster models with integrated belt clips and spare battery pouches are available.

Wrist Lanyard (Model SL-LANYARD-1)

The black wrist lanyard attaches to the bottom corner of the terminal providing additional security from accidental drop during terminal use.

Stylus (Model 75e-Stylus)

The stylus has a special tip for added accuracy and ease when operating the touch panel. The tether is a coiled, elastic cord, which secures the stylus to the terminal to prevent accidental loss. The stylus may be ordered with or without the tether.

Battery Door Kits

Replacement battery door kits are available for both standard and extended battery door types. See [Important Battery and Battery Door Replacement Guidelines](#) on page 2-9 before ordering battery door kits for your terminal.

Battery (Models 70e-BTSC and 70e-BTEC)

The 3.7V Li-ion rechargeable battery provides the main power for the terminal. See [Battery](#) on page 2-9 for battery specifications, replacement part numbers, and guidelines for use and disposal.

Protective Rubber Boot (Model 70e-BOOT)

Protective Black Rubber Enclosure provides added protection.

Features of the Dolphin 75e

Front, Bottom, and Right Panels

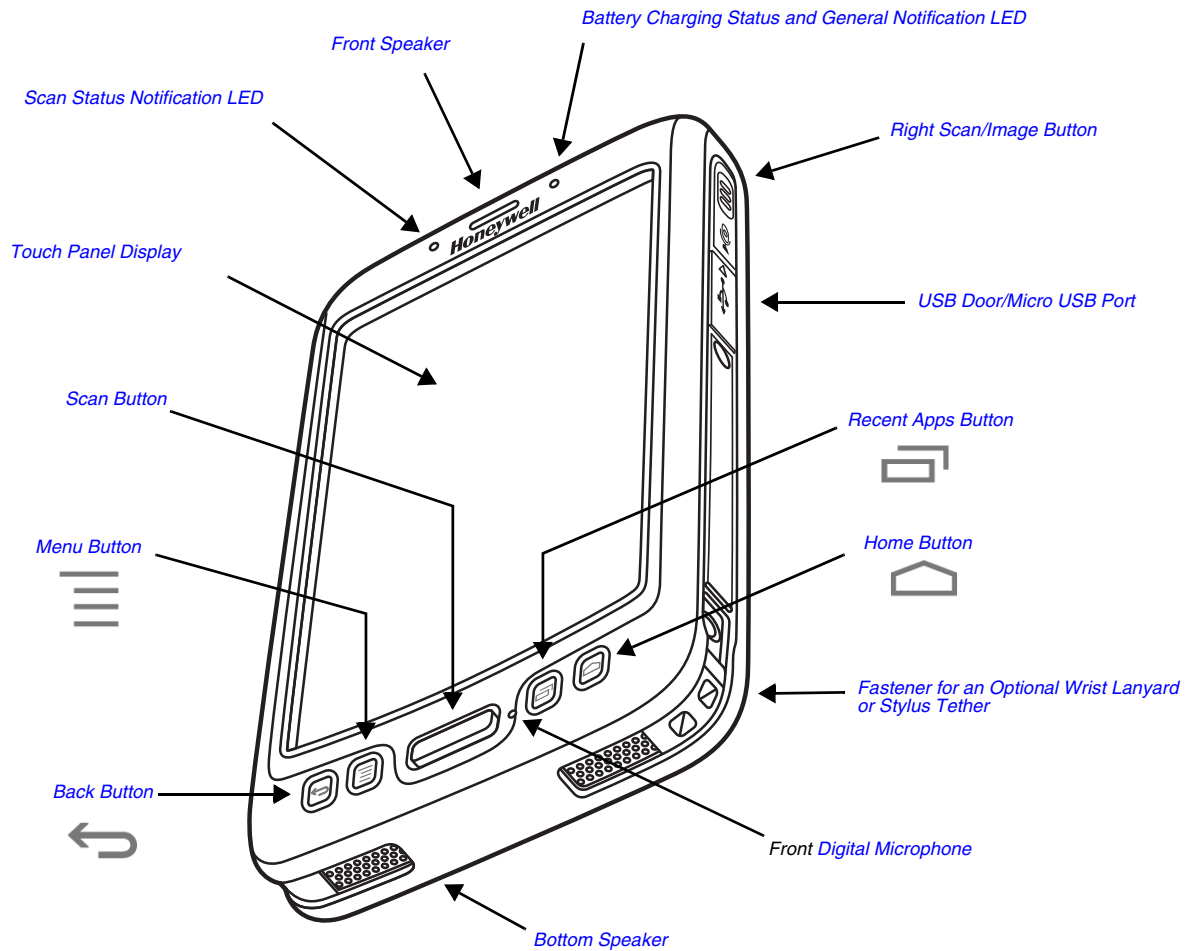

For a description of each callout, [see page 2-4](#).

Feature Descriptions: Front, Bottom, and Right Panels

Back Button

By default, the Back button returns you to the previous screen.

Bottom Speaker

The integrated bottom speaker sounds audio signals as you scan bar code labels and enter data. The integrated speaker also supports playback of wave and MP3 files, software mixer, and speaker phone for VoIP audio.

Digital Microphone

The integrated digital microphone, located on the front of the terminal provide audio input for handset VoIP calls when a headset is not plugged into the [Audio Jack](#) (see page 2-7). When a headset is plugged into the Audio Jack, the terminal defaults to the microphone on the headset. By default, the front microphone is also used for speaker phone calls, voice command audio input, and recording sound.

Front Speaker

The front speaker is the receiver for handset VoIP calls.

Fastener for an Optional Wrist Lanyard or Stylus Tether

The fastener provides access for attaching an optional wrist lanyard or stylus tether.

Battery Charging Status and General Notification LED

The light emitting diode (LED) located above and to the right of the display panel indicates the battery charge status. The LED also illuminates briefly during power up and a reboot. For detailed information on settings and meanings, see [Understanding and Changing the Battery Charge Status LED Indicator](#) on page 2-10.

Home Button

The **Home** button returns you to the Home screen, see page 1-6.

Menu Button

The **Menu** button to opens additional options and setting relevant to the open app.

Right Scan/Image Button

The right button triggers the scanner/imager when scan wedging is enabled (default) or when a scan/image demo app is open (e.g., IQ Image Demo or Scan Demo). You can reassign the button to launch applications or execute commands; see [Remap a Button Function](#) on page 1-10.

Recent Apps Button

The **Recent Apps** button allows you to view and switch between recently used apps.

Scan Button

The Scan button functions as a system wake-up control if the terminal has entered **Sleep** mode (Suspend mode). The button also triggers the scanner/imager when scan wedging is enabled (default setting) or when a scan/image demo app is open (e.g., IQ Image Demo or Scan Demo). You can reassign the button to launch applications or execute commands; see [Remap a Button Function](#) on page 1-10.

Touch Panel Display

The color 4.3 inch WVGA (480 x 800 resolution) multi-touch capacitive touch panel is covered with an industrial protective lens for greater durability. The touch panel can be activated with a finger or with the optional stylus.

*Note: To conserve battery power the touch screen dims and then turns off after a period of no activity. Press the **Power** button to wake the terminal from Sleep Mode (Suspend mode). See [Changing the Display Settings](#) on page 5-2 for information on how to adjust sleep (timeout) settings.*

USB Door/Micro USB Port

The micro USB port is located under the protective USB door on the right side of the terminal. To access the micro USB port, gently lift the top edge of the door closest to the digital microphone.

The micro USB port in conjunction with the USB Charge/Communication Cable Adapter Kit powers the terminal, charges the main battery, and facilitates communication. The micro USB port supports low, full, and high-speed USB v2.0 client communication with a maximum rate of 480 Mbps.

For additional information, see [Using the USB Charge/Communication Cable \(Model 70e-USB ADAPTERKIT\)](#) on page 1-3, and [Connecting the Terminal to a Computer \(PC\) via a USB Connection](#) on page 1-13.

The Dolphin 75e should only be connected via its microUSB connector to CTIA certified adapters, products that bear the USB-IF logo or products that have completed, the USB-IF compliance program.

Scan Status Notification LED

The light emitting diode (LED) located above and to the left of the LCD display flashes and illuminates during scan/ image capture to provide scan status information. For additional information, see [Using the Scan Image Engine](#) on page 3-1.

Back, Top, and Left Panels

For a description of each callout, see page 2-7.

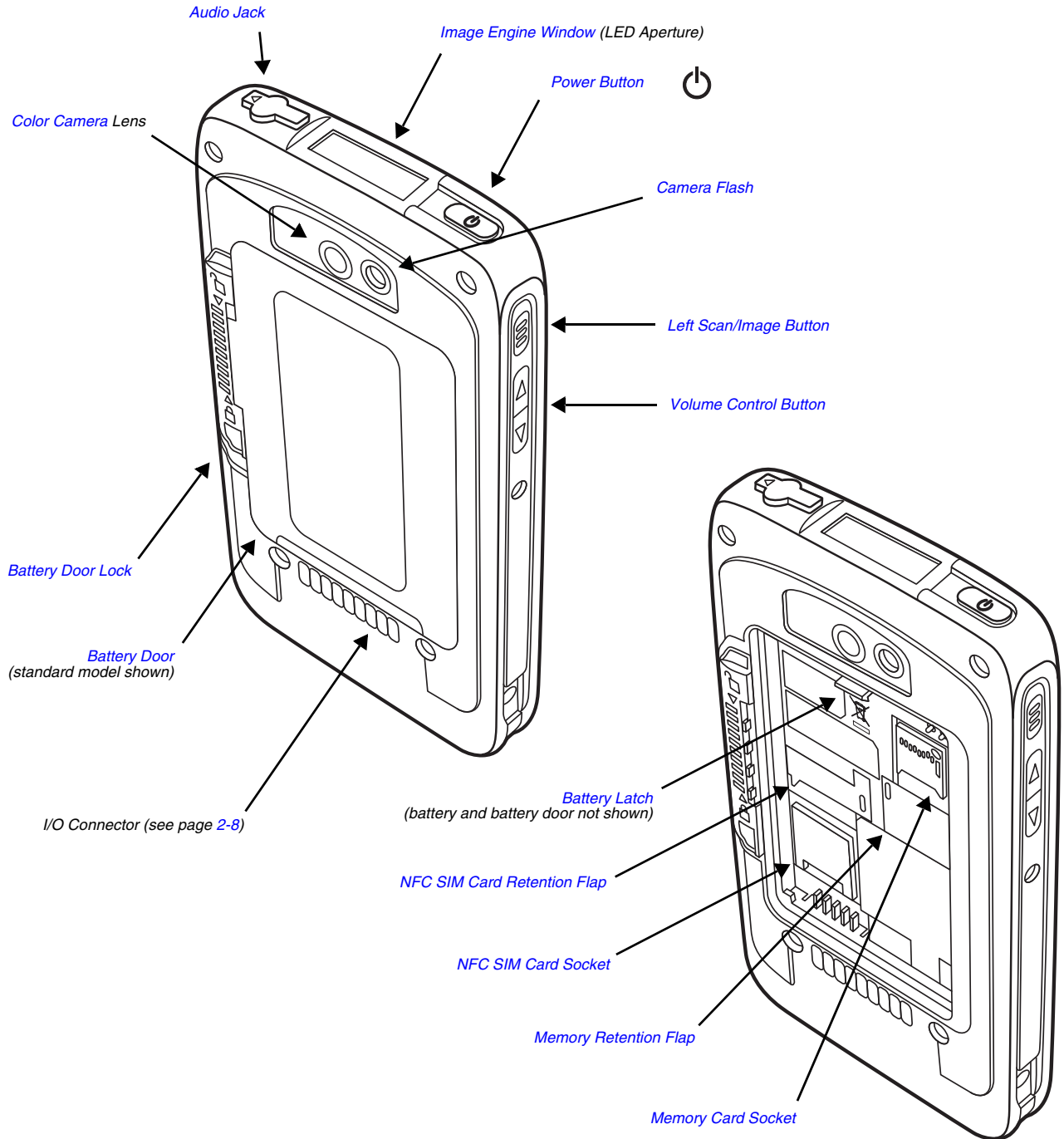

Feature Descriptions: Back, Top, and Left Panels

Audio Jack

The audio jack is located under the protective door on the top of the terminal. To access the jack gently lift the edge of the door marked with an arrow. The 3.5mm audio jack supports both speaker (stereo) and microphone (mono) headsets.

Battery

The 3.7V Li-ion rechargeable battery provides the main power for the terminal and is protected by the battery door. See [Battery](#) on page 2-9 for battery specifications, replacement part numbers, and guidelines for use and disposal.

Battery Door

The battery door protects the battery and any installed SIM and/or memory cards in the terminal's battery well. Proper installation of the battery door preserves the environmental rating of the terminal. Do not use the terminal without the battery door installed.

Battery Door Lock

The battery door lock secures the battery door to the terminal. Slide the lock down toward the IO contacts to release the lock for battery door removal and battery access. Slide the lock up toward the camera lens to secure the battery door closed and seal the battery in the terminal.

Battery Latch

The battery latch secures the battery in the battery well. Pull the latch away from the battery to release and remove the battery from the terminal. For information on [Replacing the Battery](#), see page 1-11.

Color Camera

The 8.0-Megapixel Resolution color camera provides easy picture and video capture. The camera lens and camera flash are located on the back panel of the terminal.

Camera Flash

The camera flash is located on the back panel of the terminal. When used as a Camera Flash with the integrated color camera, the flash is controlled by the camera application.

Image Engine Window

The image engine reads and decodes linear, stacked linear (e.g., PDF417), and 2D matrix bar code symbologies. The LED aperture for the imaging engine's LED aimer is contained behind this window. For more details, see [Using the Scan Image Engine](#) on page 3-1.

Left Scan/Image Button

The left button triggers the scanner/imager when scan wedging is enabled (default) or when a scan/image demo app is open (e.g., IQ Image Demo or Scan Demo). You can reassign the button to launch applications or execute commands; see [Remap a Button Function](#) on page 1-10.

Memory Card Socket

The memory card socket gives you the option to expand the terminal's memory capacity using microSD or microSDHC memory interfaces. The expansion socket is located under the battery door and battery.

When the battery door and battery pack are properly installed, the card is sealed against moisture and particle intrusion, read/write data is stored securely, and the terminal's environmental rating is preserved; see [Installing a Memory Card or NFC SIM Card](#) on page 2-12.

Memory Retention Flap

The retention flap locks the memory card in the socket; see [Installing a Memory Card or NFC SIM Card](#) on page 2-12.

NFC SIM Card Socket

The NFC SIM card socket gives you the option to install a standard NFC Secure Element (SE) SIM card. The socket is located under the battery door and battery.

When the battery door and battery pack are properly installed, the card is sealed against moisture and particle intrusion, read/write data is stored securely, and the terminal's environmental rating is preserved; see [Installing a Memory Card or NFC SIM Card](#) on page 2-12.

NFC SIM Card Retention Flap

The retention flap locks the NFC SIM card in the socket; see [Installing a Memory Card or NFC SIM Card](#) on page 2-12.

Power Button

The **Power** button  located on the top of the terminal initiates multiple functions depending on the length of time the button is pressed.

- A quick press of the button toggles the terminal in or out of Sleep Mode (Suspend mode).
- Press and hold the button for approximately 4 seconds to access additional options including: **Power, Reboot, Airplane Mode, Volume.**
- Press and hold the button down for approximately 8 seconds and the terminal automatically initiates a **Reboot.**

Volume Control Button

Press the top or bottom of the volume button to raise or lower the volume of the active speaker. Lower the volume all the way down to turn off the volume and enable vibration mode.

The I/O Connector

The I/O connector powers the terminal, charges the main battery, and facilitates communication. Dolphin 70e Black peripherals are designed to work exclusively with this connector. The I/O connector supports low, full, and high speed USB v2.0 communication with a maximum rate of 480 Mbps.

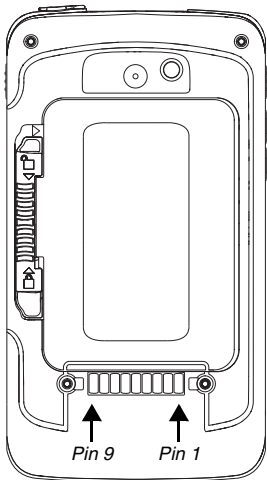
| Pin | Signal | Description | Terminal Back Panel |
|-----|-------------|--|---|
| 1 | VDC_IN | 5V DC input for charging and operation |  |
| 2 | VBUS_HOST | 5V output for USB host and peripheral power | |
| 3 | USB_DM_HOST | USB D- for the host port | |
| 4 | USB_DP_HOST | USB D+ for the host port | |
| 5 | USBC_DET | Multipurpose pin to allow for detection of an unpowered SLED, determine SLED type, and to signal a HomeBase the docking of the terminal. | |
| 6 | GND | Ground connection | |
| 7 | USB_DN_DOCK | USB D- for the client port | |
| 8 | USB_DP_DOCK | USB D+ for the client port | |
| 9 | VBUS_DOCK | 5V input for USB client (and charging) | |

Note: Signals referenced are for a DTE device.

Battery

The primary power source for the Dolphin terminal is the 3.7V Li-ion rechargeable battery located under the battery door on the back panel of the device. Honeywell recommends, you keep the battery in the terminal charged at all times to help prevent data loss. Letting the battery become fully discharged causes the terminal to lose all data in RAM.

Note: All data in RAM is cleared when the battery is removed. Always power off the terminal before removing the battery to ensure any changes made are saved to the flash memory.

Replacement Battery Specifications

Dolphin 75e model terminals are designed for use with battery part numbers BAT-STANDARD-02 (Li-ion 3.7V, 6.179 watt hour) and BAT-EXTENDED-02 (Li-ion 3.7V, 12.358 watt hour) manufactured for Honeywell International Inc. For information on how to replace the battery, see page 1-11.

Important Battery and Battery Door Replacement Guidelines

Follow the guidelines listed below when ordering batteries and/or battery doors.

- Size (e.g., standard or extended): The battery and battery door must be the same size.
- Type (e.g., locking or non-locking): Dolphin 75e models are only compatible locking type battery doors.
- Near Field Communication (NFC) requirements: Use only NFC compatible battery doors with NFC equipped Dolphin models identified with the letter N at the end of the model number (e.g., 75exxN).



We recommend use of Honeywell Li-ion battery packs. Use of any non-Honeywell battery may result in damage not covered by the warranty.

Important: All battery and connector doors must be present, undamaged, and properly closed to maintain the environmental rating of the terminal.

Invalid Battery Error Message

If the terminal displays an invalid battery error message, replace the battery with a qualified Honeywell Li-ion battery pack.

Charging Options

Dolphin 75e terminals ship with the battery significantly discharged of power. Before using a terminal for the first time, charge the battery with a Dolphin charging device for a minimum of **4 hours** for the standard battery and **6 hours** for the extended battery. When using the 70e-USB Charge/Communication cable to charge from a 500mA USB port on a host device, charge the battery for a minimum of **6 hours** for the standard battery and **8 hours** for the extended battery.

When the main battery is installed in the terminal, use one of the following:

- [Dolphin 70e Black HomeBase \(Model 70e-HB\)](#), see page 8-1
- [Dolphin 70e Black eBase \(Model 70e-EHB\)](#), see page 9-1
- [Dolphin 70e Black Mobile Base \(Model 70e-MB\)](#), see page 10-1
- [Dolphin 70e Black ChargeBase \(Model 70e-CB\)](#), see page 11-1
- [Dolphin 70e Black Net Base \(Model 70e-NB\)](#), see page 12-1
- Dolphin 70e USB Charge/Communication Cable (Model 70e-USB ADAPTERKIT) included with terminal, [see page 1-3](#)

When the main battery is not installed in the terminal:

- Place the battery pack in the [Auxiliary Battery Well](#) of the [Dolphin 70e Black HomeBase \(Model 70e-HB\)](#) or the [Dolphin 70e Black eBase \(Model 70e-EHB\)](#).
- Insert the battery in the QuadCharger (Model COMMON-QC), [see page 2-1](#).

Charging Times

| Charging Peripheral/Accessory | Model: 70e-BTSC | Model: 70e-BTEC |
|-------------------------------|-----------------|-----------------|
| | BAT-STANDARD-02 | BAT-EXTENDED-02 |
| HomeBase (Model 70e-HB) | 4 hours | 6 hours |
| eBase (Model 70e-EHB) | 4 hours | 6 hours |

| | | |
|---|---------|---------|
| ChargeBase (Model 70e-CB) | 4 hours | 6 hours |
| Net Base (Model 70e-NB) | 4 hours | 6 hours |
| Mobile Base (Model 70e-MB) | 4 hours | 6 hours |
| Mobile Charger (Model 70e-MC) | 4 hours | 6 hours |
| USB Charge/Communication Cable with provided power supply (Model 70e-USB ADAPTERKIT) | 4 hours | 6 hours |
| USB Charge/Communication Cable (Model 70e-USB) connected to a workstation (PC) 500mA USB port | 6 hours | 8 hours |
| QuadCharger (Model COMMON-QC) | 4 hours | 6 hours |

Understanding and Changing the Battery Charge Status LED Indicator

You can select the type of feedback provided by the Battery Charge Status LED on the terminal. The factory default setting is HSM Battery LED.

1. Touch **All Apps**  > **Settings**  > **Battery LED**.
2. Select one of the following options:

Default Battery LED

| Terminal Connected Charger | LED Illumination | Battery Charge Level |
|----------------------------|------------------|--|
| No | Blinking Red | Battery level is below 15% |
| No | Off | Battery level is more than 15% (including 15%) |
| Yes | Steady Red | Battery level is below 15% |
| Yes | Steady Amber | Battery level is between 15% and 90% |
| Yes | Steady Green | Battery level is above 90% (including 90%) |

HSM Battery LED (Factory Default Setting)

| Terminal Connected to Charger | LED Illumination | Battery Charge Level |
|-------------------------------|------------------|--------------------------------------|
| No | Blinking Amber | Battery level below 20% |
| No | Off | Battery level is more than 20% |
| Yes | Steady Amber | Battery level is between 0% and 60% |
| Yes | Blinking Green | Battery level is between 60% and 95% |
| Yes | Steady Green | Battery level is above 95% |
| Either | Blinking Red | Battery error |

No Battery LED

When selected, the LED does not provide charge status feedback.

Important Charging Guidelines

Source Current Specifications

Battery charging times can be significantly lengthened or charging may not occur if the terminal is drawing more current than is supplied by the charging peripheral (e.g., HomeBase, eBase, Mobile Base, or ChargeBase), USB wall charger, or USB Host (e.g., workstation PC).

- The maximum current supplied through a charging peripheral is 2.0A.
- The maximum current supplied by the USB wall charger is 900mA.

- The maximum current supplied by a USB Host can vary from 100mA to 500mA. Do not attempt to charge the terminal from a 100mA source. An active Dolphin terminal uses more current than supplied by a 100mA source causing the terminal to continue to draw power from the battery.

*Note: Placing the terminal in **Sleep Mode** (Suspend mode) while charging reduces the current draw of the terminal and shortens the charging time of the battery.*



To verify the battery is charging, touch **All Apps**  > **Settings**  > **Battery**.

Charging a Severely Low or Completely Discharged Battery

The terminal powers off if the battery charge goes below 1%. Connect the terminal to an AC power source for charging. When you first connect the terminal to power for charging, the battery status LED on the terminal flashes red. As the battery charge reaches approximately 2%, the battery status LED changes to a steady amber and a battery charging icon briefly appears on the touch panel screen. Once the battery reaches a safe charge threshold, the terminal boots when the Power button is pressed. The length of time before the battery reaches a safe charge threshold varies depending on the extent of the battery discharge.

Note: If you are charging the terminal from a USB host device (PC) using the USB Charge/Communication Cable, the length of time before the battery reaches a safe charge threshold varies depending on the extent of the initial battery discharge level and the current supplied by the USB charging source. Inadequate source current may interfere with effective battery charging.

Checking the Battery Health

To see the percentage of recharging life left on the battery touch **All Apps**  > **Settings**  > **Battery**.



Battery health is different than the amount of charge on left on the battery. For battery charge level information, select Battery under Settings.

Managing Battery Power

Letting the battery become fully discharged causes the terminal to lose all data in RAM. Honeywell recommends, you keep a charged battery in the terminal at all times to help prevent data loss. Removing the battery from the terminal erases all non-persistent memory.

When the terminal is running on battery power (as opposed to external power), warnings are displayed when the battery reaches critical and low battery points.

Checking Battery Power and Monitoring Battery Power Use

Touch **All Apps**  > **Settings**  > **Battery** to display information the battery status (charging or discharging), the level (percentage) of charge remaining on the battery, and a breakdown of battery usage statistics for any running apps and services.

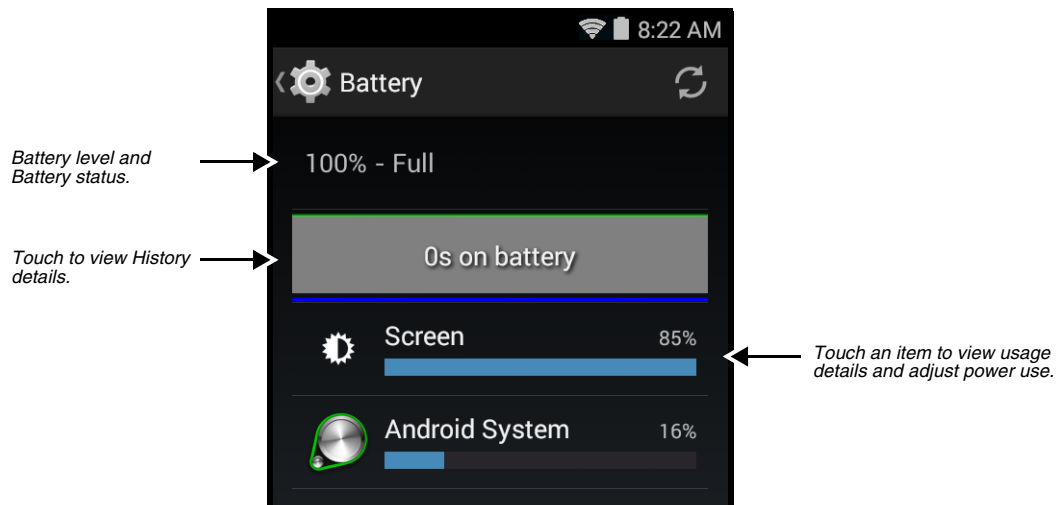

Storing Batteries

To maintain top performance from batteries, avoid storing batteries outside of the following temperature ranges:

- 14°F to 113°F (-10°C to +45°C) for short term storage of less than one month
- 32°F to 86°F (-0°C to +30°C) for long term storage

Do not store batteries in extremely high humidity. For prolonged storage, do not keep batteries stored in a charger that is connected to a power source.

Guidelines for Battery Pack Use and Disposal

The following are general guidelines for the safe use and disposal of batteries:

- Do not disassemble or open crush, bend or deform, puncture or shred.
- Do not modify or remanufacture, attempt to insert foreign objects into the battery, immerse or expose to water or other liquids, expose to fire, explosion or other hazard.
- Improper battery use may result in a fire, explosion or other hazard.
- We recommend use of Honeywell Li-ion battery packs. Use of any non-Honeywell battery may pose a personal hazard to the user.
- Only use the battery for the system for which it is specified. Do not use a battery in any other manner outside its intended use in Dolphin terminals and peripherals.
- Only use the battery with a charging system that has been qualified with the system per standard IEEE-Std-1725-2006. Use of an unqualified battery or charger may present a risk of fire, explosion, leakage, or other hazard.
- Replace the battery only with another battery that has been qualified with the system per this standard, IEEE-Std-1725-2006. Use of an unqualified battery may present a risk of fire, explosion, leakage or other hazard.
- Replace defective batteries immediately; using a defective battery could damage the Dolphin terminal.
- Never throw a used battery in the trash. Promptly dispose of used batteries in accordance with local regulations.
- Do not short-circuit a battery or throw it into a fire; it can explode and cause severe personal injury. Do not allow metallic conductive objects to contact battery terminals.
- If you observe that the Honeywell battery supplied is physically damaged, please send it to Honeywell International Inc. or an authorized service center for inspection, see [Customer Support](#).
- Battery usage by children should be supervised.
- Avoid dropping the terminal or battery. If the terminal or battery is dropped, especially on a hard surface, and the user suspects damage, send it to a Honeywell International Inc. or an authorized service center for inspection.
- If you are not sure the battery or charger is working properly, send it to Honeywell International Inc. or an authorized service center for inspection, see [Customer Support](#).
- Excessive discharge can degrade battery performance. Recharge the battery when your terminal indicates low battery power.
- Although your battery can be recharged many times, the battery life is limited. Replace it after the battery is unable to hold an adequate charge.

System Resets

See [Restarting the Terminal](#) on page 1-12.

Hardware Maintenance

When needed, clean the image engine window and the touch screen with a clean, non-abrasive, lint-free cloth. The terminal can be cleaned with a damp cloth.

Important: All battery and connector doors must be present, undamaged, and properly closed to maintain the environmental rating of the terminal.

Installing a Memory Card or NFC SIM Card

You can expand the terminal's memory capacity by installing a microSD or microSDHC card. Honeywell recommends the use of Single Level Cell (SLC) industrial grade microSD or microSDHC memory cards with Dolphin terminals for maximum performance and durability. Contact a Honeywell sales representative for additional information on qualified memory card options.

Note: Format memory card before initial use.

Installation and/or Replacement

To install a memory card:

1. **Power Off** the terminal.
2. Unlock and remove the battery door.

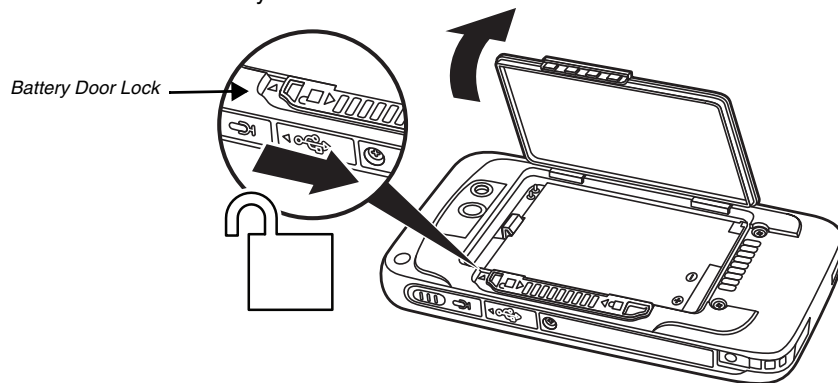

3. Pull the battery latch back and remove the battery.

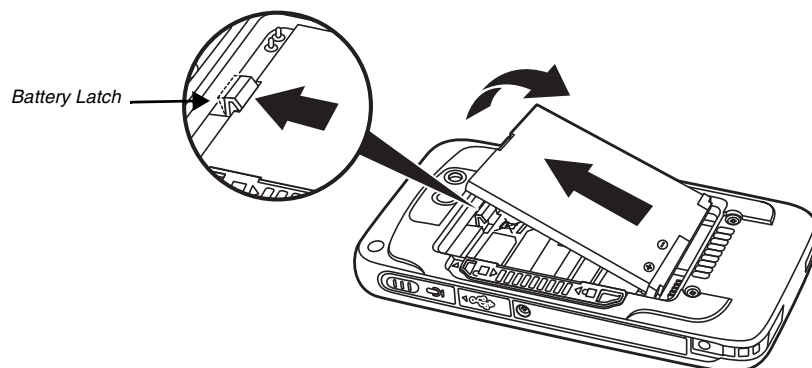

4. Lift the card retention flap for the appropriate socket, slide the card (contacts facing down) into the socket, and then close the retention flap.

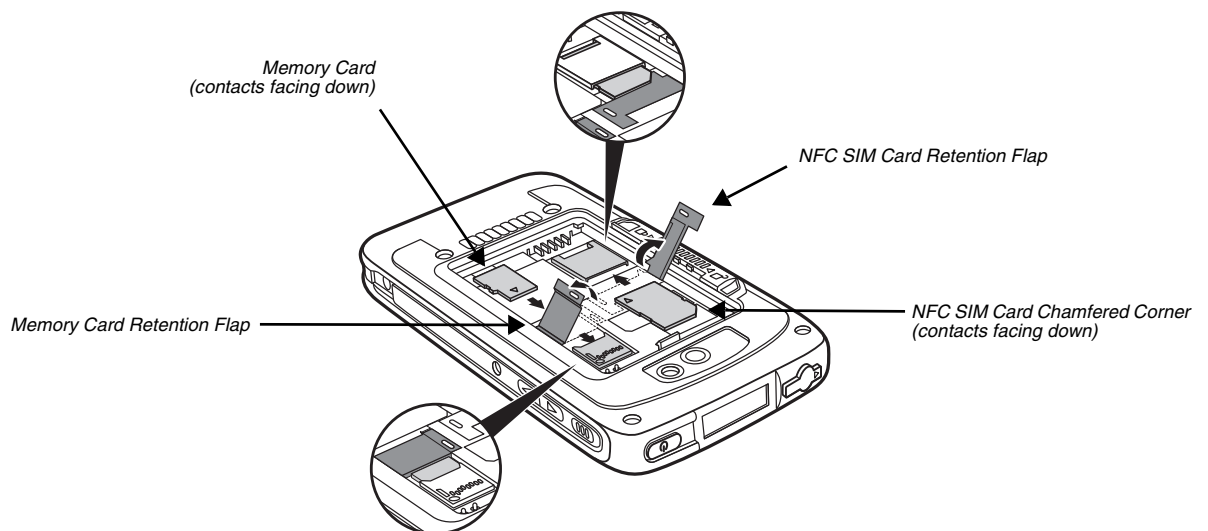

5. Install battery and battery door. Apply pressure to the edges of the battery door to ensure the door is properly closed, and then engage the door lock.

6. Press the **Power** button  .

Using the Scan Image Engine

Overview

The Dolphin 75e terminal houses a compact image engine that instantly reads popular 1D and 2D bar codes and supports omni-directional aiming and decoding for greater flexibility in real-world settings. The image engine can also capture black and white digital images, such as signatures and pictures of damaged inventory.

With the latest CMOS-based technology, the engine works like a digital camera and enables black and white digital image capture, signature capture, and reading of OCR characters.

Image Engine Specifications

Field of View

Horizontal Field Angle (°) 21.9+/-0.5 degree

Vertical Field Angle (°) 15.9+/-0.5 degree

Depth of Field

The depth of field measurements used the following parameters:

- Distances are measured from the front of the engine.
- +23°C (+73°F), 0 lux
- Photographic quality codes

| Symbology | Distance (in/cm) Near | Distance (in/cm) Far | Delta (in/cm) |
|-------------------|--------------------------|-------------------------|---------------|
| 3 mil C39/128 | - | - | - |
| 5 mil C39/128 | 2.25 (5.7) | 4.35 (11.049) | 2.1 (5.3) |
| 7.5 mil C39/128 | 1.25 (3.2) | 6.87 (17.4) | 5.62 (14.3) |
| 10 mil C39/128 | 0.67 (1.7) | 9.93 (25.2) | 9.26 (23.5) |
| 15 mil C39/128 | 1.01 (2.6) | 15.16 (38.5) | 14.15 (35.94) |
| 20 mil C39/128 | 1.80 (4.57) | 18.56 (47.14) | 16.76 (42.57) |
| 100% 13 mil UPC | 1.57 (3.9) | 12.18 (30.9) | 10.61 (26.9) |
| 5 mil PDF417 | - | - | - |
| 6.7 mil PDF417 | 1.53 (3.8) | 4.63 (11.7) | 3.1 (7.8) |
| 10 mil PDF417 | 1.38 (3.5) | 7.34 (18.6) | 5.96 (15.1) |
| 5 mil microPDF | - | - | - |
| 5 mil DataMatrix | - | - | - |
| 10 mil DataMatrix | 1.52 (3.8) | 4.87 (12.3) | 3.35 (8.5) |
| 20 mil DataMatrix | 1.07 (2.7) | 9.66 (24.5) | 8.59 (21.8) |
| 10 mil QR | 1.50 (3.8) | 5.13 (13.0) | 3.63 (9.2) |
| 20 mil QR | 2.48 (6.3) | 9.66 (24.5) | 7.18 (18.2) |
| 32 mil Maxicode | 1.56 (3.9) | 13.19 (33.5) | 11.63 (29.5) |

Supported Bar Code Symbolologies

| Symbology Type | Symbology Name |
|-------------------------|--|
| 1D Symbolologies | Codabar Code 3 of 9 Code 11 Code 32 Pharmaceutical (PARAF) Code 93 Code 128 EAN with Add-On EAN with Extended Coupon Code EAN-8 EAN-13 GS1-128 GS1 Databar Interleaved 2 or 5 ISBT 128 Matrix 2 of 5 MSI Plessey Straight 2 of 5 IATA Straight 2 of 5 Industrial Telepen Trioptic Code UPC with Add On UPC-A UPC-E |
| 2D Symbolologies | Aztec Codablock A Codablock F Data Matrix GS1 Databar MaxiCode Micro PDF PDF417 QR Code |
| Composite Codes | UPC/EAN UCC/EAN GS1 Databar |
| OCR | MICR E 13-B OCR-A OCR-B |
| Postal Codes | Postnet and most international 4-state codes Australian Post British Post Canadian Post China Post |

Decoding

The terminal supports image decoding for use in various bar code reading and imaging applications. Full-area imaging provides omni-directional reading of linear and non-linear 1D and 2D bar codes, OCR, signature capture, and picture taking.

When reading all bar code types using full-area imaging, a positive read can be obtained from many positions; see [Aiming Beam](#) on page 3-8. To achieve the best read, the aiming beam should be centered horizontally across the bar code.

Scan Wedging

The scan wedge feature sends scanned bar code data to an active application as Android keyboard input. By default, scan wedging is enabled on Dolphin 75e terminals. Applications coded to use the scanner or applications that receive data through the scan wedge feature can be used. If an application claims the scanner through the BarcodeReader API, the scan wedge feature is temporarily disabled. Detailed information on how to create custom applications for your Dolphin terminal is provided in the *Software Development Kit (SDK)*, available for download at www.honeywellaidc.com.

Scan Data Processing and Settings

The scan wedge settings control the actions that occur between scanning a bar code and wedging the data to the application. The following table identifies the settings associated with each step in the scan data process.

| Process Step | Associated Scan Setting |
|---------------------------------|-------------------------|
| Decode bar code | Symbology Settings |
| Interpret bar code as ISO8859-1 | |

| Process Step | Associated Scan Setting | |
|---|--------------------------|--|
| Detect special bar codes and implement specific action instead of normal processing. <ul style="list-style-type: none"> • URL bar code starts browser • Scan-to-Intent starts an application • EZConfig bar code starts EZConfig | Data Processing Settings | Launch Browser Scan To Intent Launch EZ Config |
| Convert to selected character set | Data Processing Settings | Charset |
| Attach Prefixes and Suffix. The data string is composed in the following order: <ul style="list-style-type: none"> • Prefix • Symbology Prefix • Bar code data • Suffix Interpret substitutions of the Prefix and Suffix strings. | Data Processing Settings | Prefix Symbology Prefix Suffix |
| Activate a Total Freedom plugin. | Data Processing Settings | Data Editing Plugin |
| Inject the final data string as Android KeyEvents. | Data Processing Settings | Wedge |

Prefix and Suffix Interpretation



Substitutions occur within the Prefix and Suffix string values.

| Substring | Replacement Character Code | Wedged as a KeyEvent |
|-----------|----------------------------|----------------------|
| \r | 13 | No |
| \n | 10 | Yes |
| \t | 9 | Yes |
| \\ | '\' | No |

Changing the Scan Settings of the Default Profile

The scan wedge settings are organized by app profile. Changes made to the Default profile apply to all applications with no profile.

To modify the scan wedge Default profile:

1. Touch **All Apps**  > **Settings**  > **Scanning**.
2. Touch **Default**.
3. Select either [Data Processing Settings](#), [Symbology Settings](#), [Imager Settings](#), [Trigger Settings](#) or [Notification Settings](#).
4. Modify the settings to meet your application needs.

To discard all changes made to the Default profile and restore the default values:

1. Touch more  in the upper right corner of any scan settings screens,
2. Touch **Restore all defaults**.

Important: This option effects all settings within the profile not just the specific settings screen open at the time the option is selected.

Data Processing Settings

| Setting | Description | Default Value |
|---------------------|---|----------------------|
| Wedge | Enable or disable sending the bar code data as Android KeyEvents, when sending data to the active application. | Enabled |
| Charset | Select the character set used when interpreting the bar code byte data into a string. <ul style="list-style-type: none"> • ISO-8859-1 • US-ASCII • UTF-16 • UTF-16BE • UTF-16LE • UTF-8 Corresponds to BarcodeReader property: PROPERTY_DATA_PROCESSOR_CHARSET | ISO-8859-1 |
| Prefix | Define string added before the decoded bar code data. | None |
| Suffix | Define string added after the decoded bar code data. | None |
| Data Editing Plugin | Specify a Total Freedom data editing plug-in. | No plug-in specified |
| Symbology Prefix | Specify a symbology identifier prefix to the bar code data. <ul style="list-style-type: none"> • None • Honeywell • AIM | None |
| Launch Browser | Enable or disable URL bar code handling. If a bar code starts with http:// or https://, the browser opens using the bar code data as a URL. Corresponds to BarcodeReader property PROPERTY_DATA_PROCESSOR_LAUNCH_BROWSER. | Enabled |
| Scan to Intent | Enable or disable special handling of scan-to-intent bar codes. Applies to bar codes in one of the following formats: <pre> // ACTION // intent-suffix '\$' extra-data </pre> Where: ACTION and extra-data are any string of characters. Launches an application listening for the intent: Intent action: "com.honeywell.scantointent.intent.action." + ACTION Intent extra "com.honeywell.scantointent.intent.extra.DATA" contains the remainder of the bar code data after the first '\$' character. Corresponds to BarcodeReader property PROPERTY_DATA_PROCESSOR_SCAN_TO_INTENT | Enabled |
| Launch EZ Config | Enable or Disable special handling of EZConfig bar codes. Applies to EZConfig bar codes, which are encoded with the Aztec symbology and containing specific header data. Corresponds to BarcodeReader property PROPERTY_DATA_PROCESSOR_LAUNCH_EZ_CONFIG. | Enabled |

Symbology Settings

The Symbology Settings specify how bar codes are decoded during scanning. Symbologies with a check mark to the right are enabled. To enable or disable a symbology, touch the check box. Select a symbology name from the list to access configuration parameters specific to the symbology type. Swipe up or down to scroll up or down the list of available symbologies.

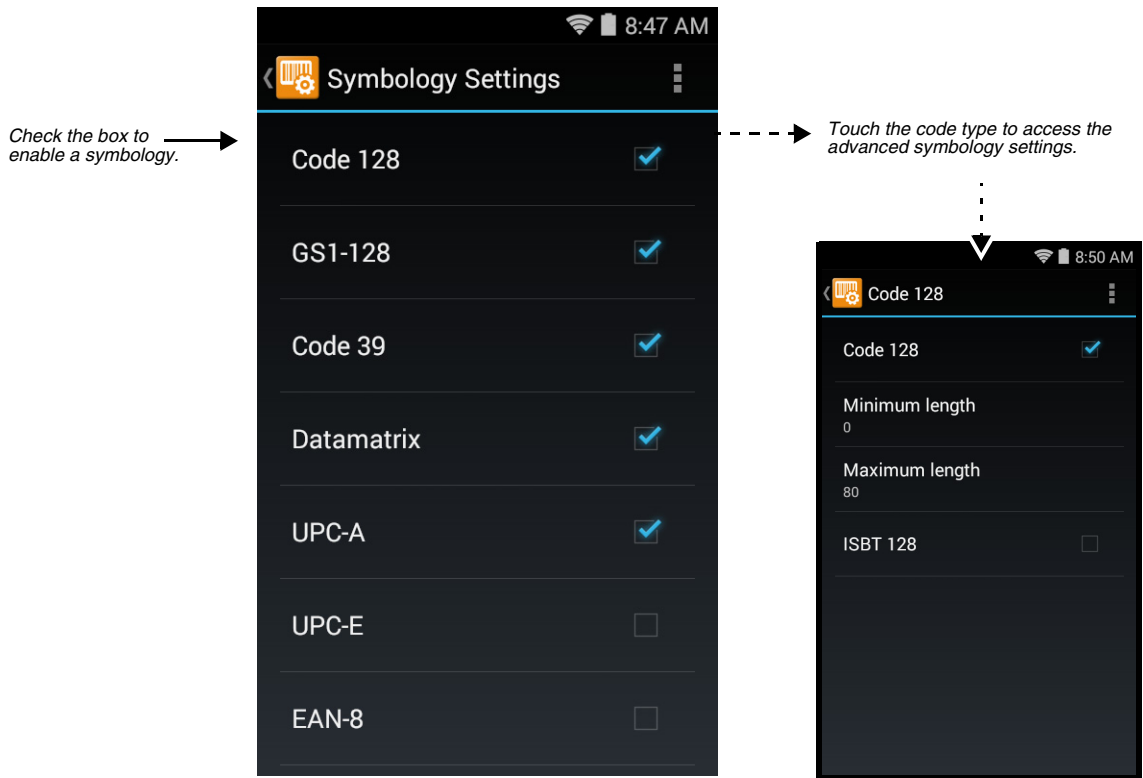

Imager Settings

The Override Recommended Values setting is disabled by default. The recommended Imager Settings are designed to work in a wide range of environments and should not normally need to be modified.

Trigger Settings



| Setting | Description | Default Value |
|----------------|---|---------------|
| Decode Timeout | Scanning will automatically turn off after this number of seconds if the scan trigger is held and nothing has successfully decoded. | 20 |

Notification Settings

| Setting | Description | Default Value |
|------------------------|--|---------------|
| Good Read Notification | Enable or disable a good read notification. The notification includes a short green blink of the scan LED, a short beep tied to the system volume, and optionally a short vibration. | Enabled |
| Bad Read Notification | Enable or disable notification of a failed scan. The notification includes a short red blink of the scan LED, an error beep tied to system volume, and optionally a short vibration. | Disabled |
| Vibrate Enabled | Enable or disable vibrate along with Good Read or Bad Read notifications. | Disabled |



Adding a Scanning Profile

To create a scan setting profile for a custom app on the terminal:

1. Touch **All Apps**  > **Settings**  > **Scanning**.
2. Touch the **plus sign** (+) in the upper right corner of the App Profiles screen.
3. Select the custom app from the Target App list. The profile appears on the App Profiles screen list. You can now select and modify the scan settings of the new profile.

Using the Scan Demo to Decode a Bar Code

The Scan Demo demonstrates the functionality of the integrated scan image engine in the terminal and is not intended as a functional business solution. Detailed information on how to create custom applications for your Dolphin terminal is provided in the *Software Development Kit (SDK)*, available for download at www.honeywellaidc.com.

1. Touch **All Apps**  > **Demos**  > **Scan Demo**  to open the Scan Demo application.
2. Point the Dolphin terminal at the bar code. For optimum performance, avoid reflections by scanning the bar code at a slight angle.
3. Touch and hold **Scan** or press and hold the **Scan** button. Center the aiming beam over the bar code; see [Aiming Beam](#) on page 3-8..

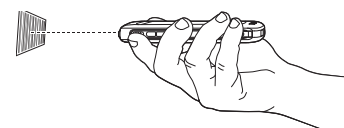

Note: By default, the left and right side buttons also trigger the scan/imager.

4. The bar code is decoded and the results appear on the screen.

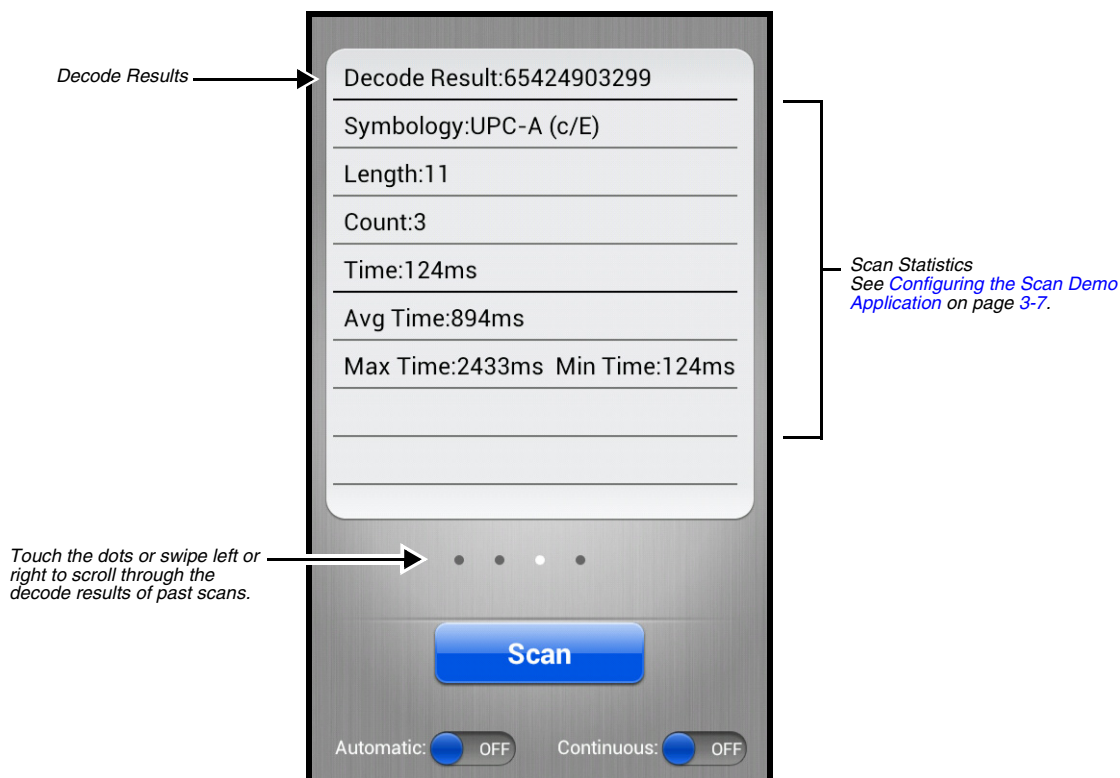

Automatic Scanning

Enable **Automatic** scanning mode to activate the imager for continuous scanning without requiring the operator to touch **Scan** for each bar code presented in the field of view of the imager. To configure the time interval between scan attempts, see **Auto Scan Delay** under [Configuring the Scan Demo Application](#) (page 3-7).



1. Slide the Automatic blue button to the **ON** position to enable the feature.
2. Touch **Scan** or press the **Scan** button to activate the imaging engine. Once activated, the imager automatically scans and decodes bar codes presented in the field of view.
3. Touch **Scan** or press the **Scan** button to deactivate the imager.
4. Slide the Automatic blue button to the **OFF** position to disable the feature.

Continuous Scanning

Enable **Continuous** scanning mode to activate the imager for continuous scanning only when the operator touches and holds **Scan** or presses and holds the **Scan** button. The time interval between scan attempts is minimal and not configurable.

1. Slide the Continuous blue button to the **ON** position to enable the feature.
2. Touch and hold **Scan** or press and hold the **Scan** button to activate the imaging engine. The imager scans and decodes bar codes presented in the terminal's field of view as long as Scan or the **Scan** button is pressed.
3. Release **Scan** or the **Scan** button to deactivate the imager.
4. Slide the Continuous blue button to the **OFF** position to disable the feature.

Configuring the Scan Demo Application

1. Open the **Scan Demo** application, and then press the **Menu** button .
2. Touch **Scan Settings**, **Symbology Settings**, or **Notification Settings**.
3. Modify the settings to meet your application needs, and then press the **Back** button  to return to the Scan Demo screen.

Scan Settings

Touch the check box to enable or disable a feature. A check mark indicates enabled.

| Setting | Description | Default Value |
|-------------------------|--|----------------------|
| View Statistics | When enabled, scan results displayed include the length of bar code, the number of scans completed, the number of milliseconds (ms) to decode the bar code, the average decode time of all the bar codes decoded, the shortest decode time of all bar codes decoded, and the longest decode time of all bar codes decoded. | Enabled |
| Auto Scan Delay | Program the number of seconds between scan attempts by tapping the menu arrow, and then entering the delay interval in second. The value should be greater than 0 and less than 100000. Touch OK to save. | 1 |
| Auto Send | When enabled, decoded data is sent to a designated server. | Disabled |
| RF Configuration | Touch to view and/or edit the Server IP address and the Port used for RF communication. When the Back button is pressed, the terminal attempts to establish communication. | |

Symbology Settings

For information on these settings, [Symbology Settings](#) on page 3-7.

Notification Settings

For information on these settings, [Notification Settings](#) on page 3-5.

Using the Demo to Save a Picture for Troubleshooting

If a bar code is producing errors and you need to supply an image of the code to a support representative for troubleshooting purposes, you can use the Scan Demo to capture a JPG of the bar code using the camera.

1. Open the **Scan Demo** application, and then press the **Menu** button .
2. Touch **Capture Error Barcode**.
3. Point the camera lens (located on the back of the terminal) at the bar code.
4. Touch the camera shutter to capture the image.
5. Touch the check mark to save the JPG image to the Internal storage\honeywell\scandemo folder.

Aiming Beam

The aiming beam is smaller when the terminal is held closer to the code and larger when it is farther from the code. Symbologies with smaller bars or elements (mil size) should be read closer to the unit whereas symbologies with larger bars or elements (mil size) should be read farther from the unit.

Linear Bar Code.



2D Matrix Symbol



Capturing Images

The image-capture process is an intuitive, split-second operation for experienced users. By following the basic guidelines, new users can easily develop their own technique and, with practice, quickly learn to adapt it to different application environments.

Image Preview: When the imaging process is initiated, the touch screen displays a preview of the object. This is a live video image of what the imager is currently viewing.



File Formats: File formats supported for image storage include JPEG (JPG) and Portable Network Graphics (PNG). The default file format for images is a grayscale JPEG.

Compression: Digital images have a maximum image size of 832 x 640 pixels and may have up to a 256 grayscale image definition. The image quality and related file size are determined by the data compression method used by the software application used to take images. The average size of the image file is approximately 400–800K. However, the size of the image depends on the content of the image - the more complex the content, the larger the file size.

Using the IQ Image Demo to decode intelligent bar codes and capture images

Decode an intelligent bar code, insert the data into predefined data fields, and capture an image of the bar code using the **IQ Image Demo**. The demo includes four format options: **Delivery**, **Postal**, **Embed**, and **No format**. Each format is designed to decode data from bar codes specifically coded to match the format of the option screen.

Note: The IQ Image Demo demonstrates the functionality of the integrated scan image engine in the terminal and is not intended as a functional business solution. Detailed information on how to create custom applications for your Dolphin terminal is provided in the Software Development Kit (SDK), available for download at www.honeywellaidc.com.

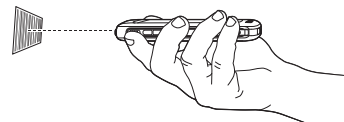

1. Touch **All Apps**  > **Demos**  . Swipe right to scroll to the **IQ Image Demo**, then touch  .
2. Touch one of the four format options: **Delivery**, **Postal**, **Embed**, or **No format**.
3. Point the Dolphin terminal at the intelligent bar code.
4. Touch **Scan** or press the **Scan** button.
5. The decode results (e.g., Tracking Number and Address embedded in the bar code) automatically populate the fields on the screen.



Note: You don't need to clear the field to take another scan, just activate the image engine again.



6. Press the **Menu** button  , and then tap **File** to save an image of the scan or bar code. The file is saved in the Internal storage\honeywell\IQdemo folder on the microSD card.

Configuring the IQ Image Demo Application

1. Open the **IQ Image Demo** application, and then touch one of the four configuration options (i.e., **Delivery**, **Postal**, **Embed** or **No format**).
2. Press the **Menu** button  .
3. Touch **Setting**  to access and modify **Image Type** (i.e., **Binary** or **Grayscale**) or **Sound** to toggle audible feedback on or off for successful scans.

Using the Signature Demo

The Signature Demo captures a signature on the touch screen.

1. Touch **All Apps**  > **Demos**  . Swipe right to scroll to the **Signature Demo**, then touch .
2. Using a finger or the optional stylus, sign the touch screen.

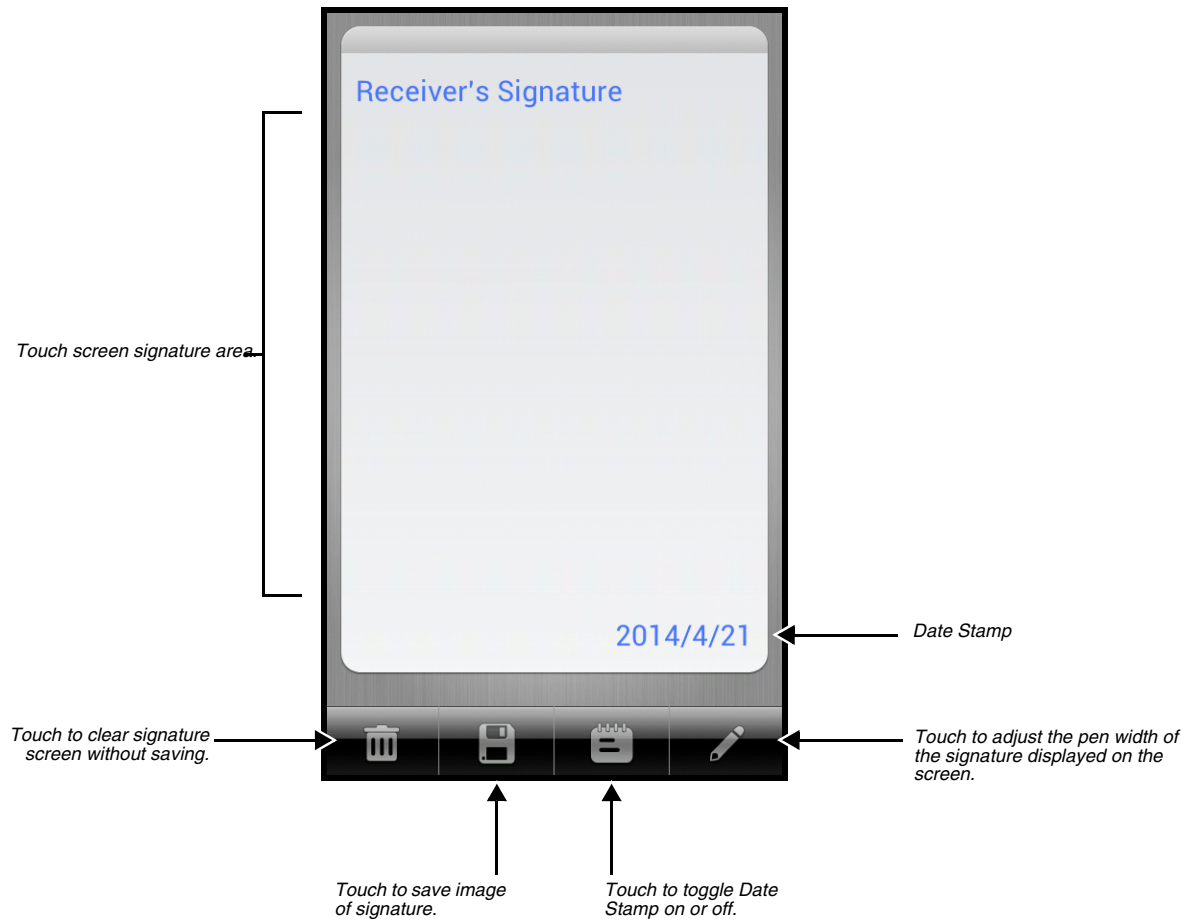

3. Touch .
4. Enter a **name** for the of the image file you want to save, and then select the file type: **JPEG** or **PNG**.
5. Touch **Save**. The signature image file is saved in the Internal storage\honeywell\signaturedemo folder.

Uploading Images

Image files can be uploaded to a host workstation using a USB connection, [see page 1-13](#).

Using the Color Camera

Overview

Dolphin 75e terminals are equipped with 8.0-Megapixel auto focus cameras to provide easy integration of color picture and video capture into business applications. The camera lens and camera flash are located on the back panel of the terminal.

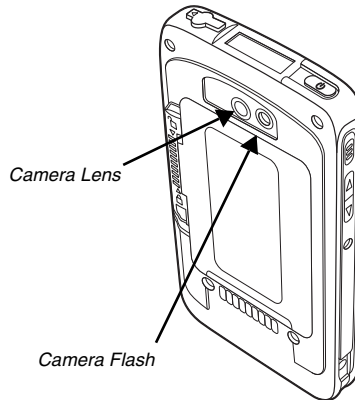

Pictures and videos captured using the **Camera app** are stored on the micorSD card in the DCIM folder under Camera (Internal storage\DCIM\Camera). You can copy your pictures and videos to a computer (see page 1-13) or view, edit, and share your pictures and videos using the **Gallery app**.

Opening the Camera app and Adjusting the Settings

To open the Camera app, touch **Camera**  on the **Home** screen.



Adjusting the Camera/Video Settings

The camera/video settings are adjustable from within the **Camera app**.

Zoom

The camera zoom is controlled using a pinching motion on the touch screen. Place two fingers on the screen at the same time, and then either spread them apart to zoom in (enlarge and object) or pinch them together to zoom out.



More Settings



Touch  to access the additional settings options .

Select each settings icon  to access different option menus (e.g., Picture Size, Sharpness, Storage Position, Store Location).







Select HDR to turn High Dynamic Range Mode on or off. When HDR is enabled, the terminal automatically captures multiple photos and combines them into one photo creating best quality image possible.

Taking a Photo







1. Open the **Camera**  app (see page 4-1).
2. Verify **single photo** mode  is selected.
3. Center the object you want to take a photo of on the live preview screen.

-
4. Touch  to capture the photo.
 5. Swipe left on the touch screen to view the captured photo. From the film strip screen you can:
 - View the captured photo.
 - Access options to share the photo.
 - Touch **More**  to access editing options, delete, view details, or set a photo as a contact photo or the Home screen wallpaper.
 - Swipe left or right to scroll through your other photos or videos.
 6. Press the **Back** button  to return to the Camera app.

Taking a Panoramic Photo

1. Open the **Camera**  app (see page 4-1).
2. Touch  to view other mode options. Select **panorama** mode .
3. Point the camera lens at the beginning of the scene you want capture.
4. Touch the **blue shutter**  to start capturing the photo.
5. Slowly sweep the camera lens across the scene using the screen preview as a guide. A progression bar appears at the bottom of the screen and the message, "Capturing Panorama" appears at the top. Once the photo has been captured, "Rendering Panorama" briefly appears on the screen.
6. Swipe left on the touch screen to view the captured photo. From the film strip screen you can:
 - View the captured photo.
 - Access options to share the photo.
 - Touch **More**  to access editing options, delete, view details, or set a photo as a contact photo or the Home screen wallpaper.
 - Swipe left or right to scroll through your other photos or videos.
7. Press the **Back** button  to return to the Camera app.

Recording Video

1. Open the **Camera**  app (see page 4-1).
2. Touch  to view other mode options. Select video mode .
3. Point the camera lens at the scene or object you want to capture in video.
4. To start capturing video, touch .
5. To stop capturing video, touch .
6. Swipe left on the touch screen to view the captured video. From the film strip screen you can and access options to share the picture or touch **More**  to view editing options, delete the image, view photo details, or set the photo as the your wallpaper or a contact photo.
7. Press the **Back** button  return to the Camera app.





Uploading Pictures and Videos

Picture and Video files can be uploaded to a computer using a USB connection. For additional information, [see page 1-13](#).



Overview

The Settings allows you to verify and/or alter system parameters to customized your terminal to meet your specific needs. Touch

All Apps  > Settings  or pull down the notification panel, touch  > Settings .

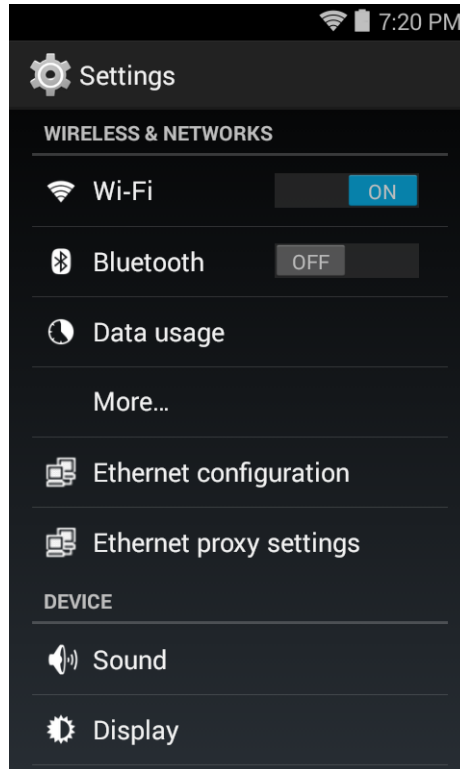

Wireless & Network Settings

For information on Wi-Fi and VPN settings, see [Wireless & Networks Settings](#), beginning on page 6-1.

For information on Bluetooth settings, see [Working with Bluetooth and NFC Technology](#), beginning on page 7-1.

For information on Ethernet settings, see [Establishing Ethernet Communication](#) on page 9-6.

Device Settings

Changing the Sound Settings

1. Touch **Sound** from the **Settings**  screen.
2. Select the configuration setting you want to modify.

Volumes

Adjust the volume sliders to set the volume level used for music, videos, games, other media, ring tones, notifications, and alarms.

Default notification sound

Select the default system notification sound.

Touch sounds

Enable or disable sound feedback during touch screen interaction.

Screen lock sound

Enable or disable sound when screen is unlocked.

Vibrate on touch

Enable or disable vibration feedback during touch screen interaction.

Changing the Display Settings

1. Touch **Display** from the **Settings**  screen.
2. Touch the configuration setting you want to modify.

Brightness

Adjust the slider to a fixed display brightness level or select **Auto** if you want the terminal to automatically adjust the brightness of the screen.

Wallpaper

Select the **Home** screen background by selecting a photo from the **Gallery** or one of the **Live Wallpapers** or **Wallpapers** available.

Auto-rotate screen

The display automatically adjusts the orientation of the screen between landscape and portrait when the terminal is rotated. Touch the **Auto-rotate screen** check box to toggle the option on or off.

Sleep

The touch screen dims and then turns off after a specified period of inactivity to save battery power. Touch **Sleep** and select how many minutes or seconds you want to elapse before the screen automatically turns off and the terminal enters **Sleep** mode (Suspend mode). For information on **Sleep** mode (see page [1-10](#)).

Daydream

You can set up a screen saver for when the terminal is charging or docked.

1. To turn the **Daydream feature** On or Off touch the toggle box .
2. Select the type of screen saver you want activated and then adjust the settings for the option by touching
3. Touch **When to Daydream** and select either **While docked**, **While charging**, or **Either**.
4. Touch **Start Now** to preview the screen saver.

Font size

Select the screen font size.

Viewing Storage Statistics

Touch **Storage** from the **Settings**  screen to view use and space statistics for the internal storage on the terminal and memory card if installed.

SD card Utilities

From the Storage settings screen, you can select **Unmount SD card** for safe memory card removal and use **Erase SD card** to erase all data on the installed memory card or **Encrypt SD card** to encrypt the data on the card.

Changing the Battery Settings

See [Managing Battery Power](#) on page [2-11](#).

Managing Apps

Touch **Apps** from the **Settings**  screen to view, evaluate, and modify how applications installed on the terminal or SD card utilize memory and storage resources.

Touch the tabs at the top of the **Apps** screen to view lists organized into four categories:

- Select **Downloaded** to display all apps downloaded to the terminal.
- Select **Running** to display application processes and services running on the terminal and cached background processes. Touch **Show cached processes** or **Show running services** at the top of the screen to switch between the lists.
- Select **All** to display all apps stored on the internal storage of the terminal.

To sort a list, press the **Menu** button , and then touch **Sort by size** or **Sort by name**.

Displayed at the bottom of each category screen is the memory or storage type, the amount of storage or memory used by the listed applications, and the amount of free space remaining.

Note: You can also reach the **Apps** screen from the Home screen by pressing the **Menu** button, and then selecting **Manage apps**.

Accessing App Info

To access the **App info** screen, touch the app name. The **App info** screen contains detailed statistics on the selected app including the amount of storage or cache utilized, default launch settings, and access permissions granted to the app. Statistics useful when troubleshooting slow terminal performance, low memory issues, or an unresponsive application. The **Apps info** screen also provides access to perform the following actions:

- force stop the app
- uninstall or disable the app
- clear stored data
- clear cache
- clear any launch by default settings assigned to the app

Uninstalling or Disabling an App

1. Press the **Menu** button  from the **Home** screen, and then touch **Manage apps**.
2. Touch the application you want to uninstall.
3. Touch **Uninstall or Disable**, and then **OK** to confirm.

Stopping an App Process or Service





1. Press the **Menu** button  from the **Home** screen, and then touch **Manage apps**.
2. Touch the **Running** tab.
3. Touch the cached background process or running service you want to stop.
4. Touch **Stop**.

Personal Settings

Enabling or Disabling Location Service

Touch **Location** from the **Settings**  screen to enable or disable location services or view recent location requests by apps. Location services are used when apps access Wi-Fi or mobile networks to approximate the location of the terminal to improve search results and other services.

To enable or disable location services:

1. Touch **All Apps**  > **Settings** .
2. Touch the **Location** OFF/ON toggle box to turn the location services  or .

Managing Security

Touch **Security** from the **Settings**  screen to manage terminal security parameters (e.g., authorization for device administration, setup a screen lock, setup a SIM card PIN, enable/disable visible passwords, load security certificates, and setup a password to protect the terminal's credential storage).

Setting up a Screen Lock

The **Screen Lock** settings provide access to additional security features that enable you to prevent an unauthorized person from unlocking the touch screen and accessing the terminal.

To set up a screen lock:

1. Touch **Security** from the **Settings**  screen.
2. Touch **Screen lock**.
3. Select from five security options: **None**, **Slide**, **Pattern**, **PIN** or **Password**.
4. Enter a pattern, PIN or password, and then **Next** or **Continue**.
5. Enter the same pattern, PIN or password, and then select **Confirm** or **OK**.

To change or remove the screen lock:

1. Touch **Security** from the **Settings**  screen.
2. Touch **Screen lock**.
3. Enter your pattern, PIN or password.
4. Select **None** or select a new screen lock option.

Once you have established a screen lock, additional settings appear under the **Screen Security** heading depending on the type of security you implemented.

- **Enable widgets**
- **Make pattern visible**
- **Automatically lock**
This setting specifies the time increment for the screen to automatically lock after entering **Sleep mode**.
- **Power button instant lock**

Displaying Owner Info on the Lock Screen

Select the **Owner Info** setting to designate custom text you want displayed on the lock screen. You can also disable owner information from displaying.

Encrypting the Data on the Terminal

You can encrypt all the data on your Dolphin terminal using the **Encrypt phone** option as an advanced security measure in case your device is ever lost or stolen. When the terminal is encrypted, you must enter a numeric PIN or password each time you turn the power on. The **Screen Lock** PIN or password you set up is the same PIN or password used for encryption security and cannot be set independently.

Warning: You cannot reverse encryption. The only way to revert back to an unencrypted state is to perform a factory reset, which erases all your data.

Making Passwords Visible

Touch the **Make passwords visible** check box to toggle between hiding or showing passwords as you type.

Viewing or Deactivating Device Administrators



The **Device administrators** screen lists all applications that have been given authorization to act as a device administrator, which is often required when you set up accounts that synchronize data between the terminal and an enterprise service. An enterprise service implements security policies on the terminal before allowing a connection (e.g. passwords and certificates).

Touch **Device administrators** from the **Security** screen, and then touch the application name if you want to remove authorization for the app to act as a device administrator for the terminal.

Viewing or Changing App Permissions

Apps ops allows you to view or change permissions for a specific apps and services.

To view and modify the permissions for an app:

1. Touch **Security** from the **Settings**  screen.
2. Touch **Apps ops**.
3. Swipe left to view four app lists **Locations, Personal, Messaging, Media, Device, Bootup**.
4. Select an app or service from one of the lists.
5. Touch the toggle boxes to turn permissions  or .

Allowing Unknown Sources

Check the **Unknown sources** box to allow the installation of non-market applications. This setting is disabled by default.

Managing Trusted Credentials

For information on managing and installing security certificates, see [Working with Certificates](#) on page 6-5.

Language & input

Touch **Language & input** from the **Settings**  screen to access options to modify the default language for the display, change the automatic spelling correction settings, manage your personal dictionary, configure keyboard & input methods for text entry, manage speech settings for voice searches and text-to-speech output and set the mouse/trackpad pointer speed.

Changing the Display Language

Touch **All Apps**  > **Settings**  > **Language & input** > **Language**, and then select the language you want displayed on the touch screen.

Activating Spell Check

Touch **All Apps**  > **Settings**  > **Language & input** > **Spelling correction** to turn the feature on or off.

Touch  to change the language settings when the feature is turned on.

Managing the Personal Dictionary

Touch **All Apps**  > **Settings**  > **Language & input** > **Personal Dictionary** to add, edit, or delete words from your personal dictionary.

Changing the Keyboard & Input Methods

The virtual keyboard appears when you open an application or select a field that requires text or numerical input. The content of the keyboard may vary depending on the selected default, the application in use, and the input field requirements.

To modify the default keyboard type used for entering text:

1. Touch **All Apps**  > **Settings**  > **Language & input** > **Default**.
2. Select a keyboard. The default is **Android Keyboard (AOSP)**.

If you do not see any other keyboard options besides **Android Keyboard (AOSP)** on the list, touch **Set up input methods**. Select the keyboard you want included on the list and then press the back button .

Important: To use the full functionality of the **Enhanced Keyboard** a license must be purchased and loaded on the terminal. If no license is detected, a trial software notification message appears when you select the **Enhanced Keyboard** option. Once a license is purchased the Honeywell Enhanced Keyboard is fully customizable using the Honeywell Virtual Keypad Creator software.

Touch  next to the keyboard name to adjust settings specific for the keyboard type (e.g., Keyboard Skin, Vibrate on Key Press, Sound on Key Press, Show Key Preview, Show Settings Key, and Input Language Preference).

Customizing the Optional Enhanced Keyboard

Customization of the **Enhanced Keyboard** requires a software license purchase, downloading and installing the *Honeywell Virtual Keypad Creator* software on your computer (PC) and an active connection between the terminal and your computer. If no license is detected, a trial software notification message appears when you select the **Enhanced Keyboard** option or you attempt to upload a customized keyboard to your terminal using the *Honeywell Virtual Keypad Creator* software.



The user-friendly utility allows you to personalize multiple keyboard features including key position, size, quantity, color, and the keyboard skin. In addition, you can make language changes, create alternate or function keys for special character sets, and add application launch keys to streamline common business tasks.

There are two software components required for customizing the **Enhanced Keyboard**.

- The first is the *Honeywell Virtual Keypad Creator*, which resides on your PC and is used to design, save, and download custom keyboard layouts to your Dolphin terminal.
- The second is the enhanced Honeywell virtual keyboard file HoneywellVK.xml, which is located in the \D75E\Internal storage\HoneywellVK folder on your Dolphin terminal. This keyboard file is what displays on the terminal screen when the enhanced Honeywell virtual keyboard is selected as the default virtual keyboard; see Language & input on page 6-7.

The customization process is easy.

1. Download and install the Honeywell Virtual Keypad Creator software onto your PC.
2. Connect your Dolphin terminal your PC using the USB charge/communication cable provided.
3. Enable **Developer options** on the terminal. For information on how to enable developer options, see page 5-9.

4. Touch **All Apps**  > **Settings**  > **Developer options**. Check USB debugging.

5. Touch **All Apps**  > **Settings**  > **Security**. Check **Unknown sources**.

6. Open the Virtual Keypad Creator software on your PC.

7. Select **Android** from the Device menu, and then **Yes** to confirm changing the device platform.

8. Open and modify the standard layout or create a new layout.

Select **Help** > **Contents** or click the Help icon for detailed information on how to open, modify and create new keypad layouts.



9. Select **File** > **Save As**.

Note: The Save button overwrites the default keypad template provided with the software with any changes you have made to the layout. Make a backup copy of the template or use the Save As option if you want to keep the provided default template for later use.

10. Select **Device** > **Update Configuration**. Follow the prompts to install the custom enhanced keyboard on your terminal.



Configuring Text-to-Speech

To configure **Text-to-speech (TTS)** settings:

1. Touch **All Apps**  > **Settings**  > **Language & input** > **Text-to-speech output**.
2. Select a preferred engine used for speech synthesis when you want to hear text read aloud.
3. Touch  next to the engine to change the engine settings (e.g., language).
4. Touch **Speech rate** and select the speed at which text is spoken.

To listen to an example of speech synthesis based on the current settings select **Listen to an example**.

Adjusting the Sensitivity and Speed of the Touch Panel Response

1. Touch **All Apps**  > **Settings**  > **Language & input** > **Pointer Speed**.
2. Use the slider adjustment to change the sensitivity and speed of the touch screen response to your finger swipe.

Backup & reset

For information on performing a Factory Reset (Clean Boot), see [Resetting the Terminal](#) on page 1-13.

Honeywell Settings

Key Remapping

For information on how to change the button functions, see [Remap a Button Function](#) on page 1-10.

Modifying the Smart Sensors

Touch **Smart Sensors** from the **Settings**  screen to configure the integrated motion detection sensors for advanced power management.

Keep awake on motion

When enabled, the terminal is prevented from entering **Sleep** mode (Suspend mode) when motion is detected. By default, this option is disabled.

Wake on motion

When enabled, the terminal wakes from **Sleep** mode (Suspend mode) when motion is detected. By default, this option is disabled.

Face down suspend

When enabled, the terminal enters **Sleep** mode (Suspend mode) when placed face down on a flat surface. By default, this option is disabled.

Changing the Battery LED Functionality

See [Understanding and Changing the Battery Charge Status LED Indicator](#) on page 2-10.

Viewing the Battery Health

See [Checking the Battery Health](#) on page 2-11.

Activating the Logger

You can activate a logging service that creates an Android logcat log and kernel log for APP and system trouble shooting.

Select the ON/OFF toggle box to turn the logger OFF ON .

Scanning

For information on modifying scan application profiles, see [Scan Wedging](#) on page 3-2.

Web applications



These settings are meant to be used in conjunction with a future Web Application SDK offering.

Accounts



Adding or Modifying an IMAP or Corporate Exchange Account

Touch **IMAP** from the **Settings**  screen to view accounts and add, remove, and manage exchange accounts (e.g., e-mail) and allow apps to automatically schedule and sync data.



To add an account:

1. Touch **All Apps**  > **Settings** .
2. Touch **Add account**.
3. Select either **Corporate** or **IMAP**.
4. Follow the on-screen instructions to enter the required information for the account type selected. You may need to provide a user name and password, select security settings, and configure data sync preferences during the setup.
5. The account appears on the **Settings** > **IMAP** accounts list when setup is complete. Depending on the settings you selected during the account configuration, your terminal may automatically start to sync account data (e.g., email, contacts, music and calendar).

To modify account settings:

1. Touch **All Apps**  > **Settings**  > **IMAP**.
2. Touch **Account settings**.
3. Select either **General Settings** or a specific account.

To remove an account:

1. Touch **All Apps**  > **Settings**  > **IMAP**.
2. Touch the account to delete.
3. Press the **Menu** button , and then select **Remove account**.
4. Touch **Remove account** to confirm deletion.

System

Setting the Date & Time

Touch **Date & time** from the **Settings**  screen to access options to configure the date, time, time zone, time format, and date format displayed on the terminal. You can set the terminal to synchronize the date and time using a network connection by checking the **Automatic date & time** box or you can manually enter the values by touching **Set date**, **Set Time**, or **Select Time zone**.

To modify how the time is displayed on the screen, check the **Use 24-hour format** box to switch from a 12-hour cycle to a 24-hour cycle. In a 24-hour time cycle, 1:00 pm displays as 13:00 pm.

To change the date format displayed on the screen, touch **Select date format**, and then select a format from the list.

Customizing Services and System Features for Accessibility

Touch **Accessibility** from the **Settings**  screen to configure services and features that make using the terminal easier to use. If a service or tool is installed on the terminal, touch the name to enable or disable the service or modify the associated settings.





You can also access and configure the following system features from the Accessibility screen:

- Captions
- Magnification gestures
- Large text
- Speak passwords
- Accessibility shortcut
- Text-to-speech output
- Touch & hold delay

For detailed information on these features, go to the *Android Accessibility Help Center* at www.support.google.com/accessibility/android/#topic=6007234.

Enabling Developer Options

To access advanced settings used by Android application developers:

1. Touch **About phone** on the **Setting**  screen.
2. Tap the **Build number** seven times.
3. Press the **Back** button to return to the **Settings**  screen.
4. Touch **Developer options**.
5. Touch the ON/OFF toggle box to enable  the **Developer options** Settings  screen to access advanced settings used by Android application developers. For information on these settings, Android APIs, and development tools, refer to the Android developer web site at <http://developer.android.com>.

About Phone

The **About Phone** screen displays specific information about the terminal including: Model number, Android OS version, Processor info, Kernel version, and Build number.

Touch **Status** to view:

- Battery status
- Battery level (% of charge)
- IP address
- Wi-Fi MAC address
- Bluetooth address
- Serial number
- Up time

Touch **Legal information** to view important information on Open source licenses for the software.

For more detailed information about the terminal:

Touch **All Apps**  > **Settings**  > **Power Tools**  > **Diagnostic Information** .



Wireless & Networks Settings

Under the **Wireless & Networks** heading on the **Settings** screen there are options for turning the onboard wireless radios in the terminal on or off and for configuring network connections.

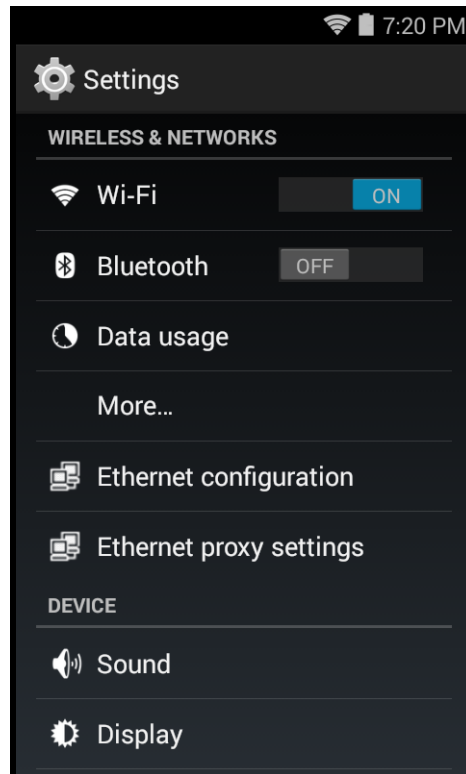

Connecting the Terminal to a Wireless Network

You connect the terminal to a wireless network through the on-board radios (802.11a/b/g/n/ac and/or Bluetooth). Each radio has its own configuration utility and requires specific information about the wireless network to connect. A successful connection depends on your network infrastructure so you may need to consult your network administrator before attempting a connection.

WLAN (802.11a/b/g/n/ac)

The Dolphin 75e has a 802.11a/b/g/n/ac WLAN (Wireless Local Area Network) radio. The radio is interoperable with other 802.11a/b/g/n/ac, Wi-Fi compliant products including access points (APs), workstations via PC card adapters, and other wireless portable devices.

Bluetooth



See [Working with Bluetooth and NFC Technology](#) on page 7-1.

Wi-Fi Network Connections

Turning Wi-Fi Networking On or Off

1. Touch **All Apps**  > **Settings** .
2. Touch the **Wi-Fi** OFF/ON toggle box to turn the radio  or .

Connecting to a Wi-Fi Network

1. Touch **All Apps**  > **Settings**  > **Wi-Fi**.
2. Verify the Wi-Fi is turned .



The terminal searches for available Wi-Fi access points within range of the device. If the terminal previously connected to a Wi-Fi network, it automatically reconnects to the same network.

3. Touch the network name you want to connect to from the available network list.
4. If the network is secured, a dialog box appears requesting information relevant to the network security protocol (e.g., password, key, or certificate). Enter the required information.
5. Touch **Connect**.



*Note: To remove a Wi-Fi network the terminal previously connected to, touch the network name, and then touch **Forget**, to delete the stored network information.*

Receiving Network Notifications

If Wi-Fi networking is turned On, you can set the terminal to notify you when an open network is available.

1. Touch **All Apps**  > **Settings**  > **Wi-Fi**.
2. Press the **Menu** button , and then touch **Advanced**.
3. Touch the check box to toggle **Network notification** On (checked) or Off.

Adding a Wi-Fi Network

1. Touch **All Apps**  > **Settings**  > **Wi-Fi**.
2. Verify the **Wi-Fi** is turned .
3. Touch the plus sign (+) located at the bottom of the available Wi-Fi network list.
4. Enter the **Network SSID** (Wi-Fi network name).
5. For secure Wi-Fi network connections, touch **None** under **Security**, and then select the type of security protocol required from the pop-up menu (e.g., **WEP**, **WPA/WPA2 PSK** or **802.1xEAP**). To access Proxy and IP settings, select to box next to "Show advanced options".
6. Enter any additional security information required by the type of security protocol selected.
7. Touch **Save**.





Advanced Wi-Fi Settings and Network Utilities

Advanced Wi-Fi Menu

The Advanced Wi-Fi menu provides access to the terminal **MAC address**, **IP address**, and the following settings:

- **Network notification**
Enables or disables available Wi-Fi network notification.
- **Keep Wi-Fi on during sleep**
Specifies how the Wi-Fi radio reacts when the terminal enters **Sleep** mode.
- **Scanning always available**
Enable or disable if apps are allowed to scan for networks even when the Wi-Fi is Off (e.g., Google Location Services).
- **Passive to Active**
Enable or disable if the channel is marked as valid for active scanning if beacons or probe responses are received.
- **Wi-Fi frequency band**
Specifies the Wi-Fi frequency band to be used (i.e., Auto, 5 GHz only, or 2.4 GHz only)
- **Install Certificates**
For information how to install certificates, see [Working with Certificates on page 6-5](#).
- **CCX Enable**
This setting is part of a future offering and not available at this time.
- **Wi-Fi optimization**
Enable or disable minimization of battery usage when Wi-Fi is On.





To access the advanced Wi-Fi menu:

1. Touch **All Apps**  > **Settings** .
2. Under **Wireless & Networks**, touch **Wi-Fi**.
3. Press the **Menu** button  or touch **More** .
4. Select **Advanced**.

Wi-Fi Radio Settings Power Tool





The **Wi-Fi Radio Settings** network utility provides several options for advanced configuration of the Wi-Fi 802.11 radio in the terminal. The settings are organized under two tabs: Basic and Advanced.

Modifying Station Mode and AP Mode Configurations

1. Touch **All Apps**  > **Power Tools**  > **Wi-Fi Radio Settings** .
2. Select the **Basic** to access Station Mode and AP Mode configuration settings.
Select the **Advanced** to access RTS Threshold or Fragmentation Threshold configuration settings.
3. Modify the settings to meet your requirements.
4. Touch **More**  in the upper right corner of the screen.
5. Select **Apply Wi-Fi settings**.

Viewing General Wi-Fi Info

The **Wi-Fi Info** power tool enables you to view the status of the Wi-Fi radio, information on current and available access points and detailed roaming statistics.

1. Touch **All Apps**  > **Power Tools**  > **Wi-Fi Info** .
2. Select **AP Info** or **Roam Tracker** to view detailed statistics or touch the **ON/OFF** toggle box  next to Wi-Fi to change the power status.

Airplane Mode

See [Turning Airplane Mode On/Off](#) on page 1-11.

Virtual Private Networks (VPN)

To complete the VPN setup screens, you may need to ask your ISP or network administrator for the proxy server name, server type, port, type of Socks protocol used, and your user name and password if you do not already have the information.

Adding a VPN Profile

1. Touch **All Apps**  > **Settings** .
2. Under **Wireless & Networks**, touch **More** > **VPN**.

*Note: VPN connections require you to set a screen lock PIN or password before you can use credential storage. If you have not set either security option, select **OK** on the pop-up notification window, and then set a screen lock PIN or password. Once you complete the process, you are automatically directed back to the VPN screen.*



3. Touch the plus sign (+) at the top of the screen to **Add VPN network**.
4. Enter the **VPN Name**, and **Type** you want to add. To continue to the next input field, select **Next** on the virtual keypad or swipe up. Complete the remaining data fields with the appropriate information for your network. The terminal supports the following protocol types:
 - PPTP
 - L2TP/IPSec PSK
 - L2TP/IPSec RSA
 - IPSec Xauth PSK
 - IPSec Xauth RSA
 - IPSec Hybrid RSA

5. Touch **Save**.

*Note: To delete a VPN, touch and hold the network name on the **VPN** screen, and then touch **Delete network**.*

*To edit a VPN configuration, touch and hold the network name on the **VPN** screen, and then touch **Edit network**. Touch **Save** to retain your changes.*

Connecting to a VPN

1. Touch **All Apps**  > **Settings** .
2. Under **Wireless & Networks**, touch **More** > **VPN**.
3. Touch the name of the VPN.
4. Enter any security credentials (e.g., password, user name, certificate information or server name) required by the VPN.
5. Touch **Connect**.

Note: When a VPN connection is established, a  shows in the status bar.

Disconnecting from a VPN

1. Drag the status bar down from the top of the touch screen to view the Notification panel.
2. Touch the VPN connection notification to disconnect.

Editing or Deleting a VPN Profile

1. Touch **All Apps**  > **Settings** .
2. Under **Wireless & Networks**, touch **More** > **VPN**.

3. Touch and hold the name of the VPN.
4. Select either **Edit profile** or **Delete profile**.
5. Edit the profile information and select **Save**.



Working with Certificates

The **Settings**  menu provides access to options that help you manage your Wi-Fi network and/or Virtual Private Network (VPN) security certificates.

Android supports DER-encoded X.509 certificates saved with a .crt or .cer file extension or X.509 certificates saved in PKCS#12 key store files with a .p12 or .pfx file extension. To install a valid certificate or key store file with a different extension, you must change the certificate or key store file extension to a supported type (e.g., .crt, .cer, .p12 or .pfx).

Installing a Certificate

To install an encrypted certificate or key file:

1. Copy the certificate from the host device (PC) to either Internal storage on the terminal or the root directory of an installed SD (optional).
2. Touch **All Apps**  > **Settings**  > **Security** > **Install from SD card**.
3. From the Open from screen, select a storage location (e.g. Internal storage or SD card), and then navigate to where you saved the file.
4. Touch the file name of the certificate or key store to install and enter a password if required.
5. Touch **OK**.
6. Enter the name of the certificate, and then touch **OK**.



Note: Once an encrypted certificate is installed on the terminal, it is automatically deleted from the SD card.

Viewing More Storage Locations or Changing the Screen View

From the Open from storage source screen, select **More**  > **Settings**.

- Select **Advanced devices** to enable full storage access (both Internal storage and external SD card, if installed).
- Select **Display file size** to show file size statistics.

After selection a storage source:

- Select **More**  to change the view (e.g., **Grid view** or **List view**) or to access **Settings**.
- Select  to sort By name or By date modified.
- Select  to search for a file.

Viewing, Disabling, or Removing Certificates

Touch **Trusted credentials** from the **Security**  menu to view all the security credentials installed on the terminal. Tabs organize the certificates into two categories: **System** and **User**. Touch the certificate name to view additional details about the certificate.

To disable a system certificate or remove a user certificate:

1. Touch **All Apps**  > **Settings**  > **Security** > **Trusted credentials**.
2. Touch the certificate name from the **System** or **User** list.

-
3. Scroll to the bottom of the Security certificate details screen.
 4. Touch **Disable** or **Remove** depending on the type of certificate you are viewing.
 5. Select **OK**.

Note: System certificates can be enabled using the same method at a later date but User certificates are permanently deleted if removed.

Ethernet Communication





See [Establishing Ethernet Communication](#) on page 9-6.

Working with Bluetooth and NFC Technology

Bluetooth Technology

Turning the Bluetooth Radio On or Off

Bluetooth™ is a short-range wireless communications technology used to exchanged data between devices over a distance of approximately 26.2 feet (8 meters). Before you can connect or pair your terminal to another device using Bluetooth technology, you must first turn on the Bluetooth radio.

1. Touch **All Apps**  > **Settings** .
2. Touch the **Bluetooth** OFF/ON toggle box  to turn the radio on . Once the Bluetooth radio is activated, the terminal automatically starts searching for discoverable devices.



Note: System bar icons at the top of the touchscreen indicate the status of the Bluetooth radio.

Pairing and Trusted Devices

The terminal supports pairing with other devices using Bluetooth technology. Pairing happens during general connection setup. Paired devices are “trusted” devices. This means that there is unrestricted access to all services (including services that require authorization and authentication).

Connecting to Other Bluetooth Devices





To connect to other Bluetooth devices, you need to perform a device search, select a discovered device, and then connect to the selected device. Pairing happens as part of the connection process.

1. Make sure the Bluetooth device you are attempting to connect to is in range and set to be discoverable by other devices using Bluetooth technology.
2. Touch **All Apps**  > **Settings** . Verify the **Bluetooth** radio is activated .
3. Touch **Bluetooth**.
4. Touch **Search for Devices** to refresh the scan started when the Bluetooth radio was first activated.
5. Touch on the name of the device you want to connect to on **Available Devices** list.
6. The Bluetooth radio attempts to connect with the device. If the device has a specific passcode, enter it when prompted.

Note: When attempting to connect to a printer or headset with Bluetooth capabilities, the passcode may default to either 1234 or 0000. If there is no default, consult the device literature for the number.

7. When the devices are paired successfully, the device name is displayed under the “Paired Devices” heading on the Bluetooth settings screen.



Configuring or Unpairing Bluetooth Devices

1. Touch **All Apps**  > **Settings** . Verify the **Bluetooth** radio is activated .
2. Touch **Bluetooth**.
3. On the **Paired Devices** list touch the settings icon  next to name of the device you want to disconnect.
4. Touch **Rename**, **Unpair** or select a different profile from the **Profiles** list available for the paired device.

Making the Terminal Discoverable

By default, the Dolphin terminal is not discoverable, which means that the terminal will not be found by other Bluetooth devices.

To make the terminal discoverable:

1. Touch **All Apps**  > **Settings** .
2. Verify the **Bluetooth** radio is activated .
3. Touch **Bluetooth**.
4. Touch Dolphin 75e (default terminal name) at the top of the screen to make the device discoverable. The terminal starts a 2 minute count down during which time the terminal is temporarily discoverable by other devices using Bluetooth technology.







Bluetooth Menu Options

You can access additional configuration options from the **Bluetooth** screen by pressing the **Menu** button .

- **Rename phone** changes the default Dolphin 75e terminal name to a custom name of your choice. Enter the new name, and then select **Rename**.
- **Visibility timeout** changes the default 2 minute visibility timeout increment. Select **5 minutes**, **1 hour** or **Never time out**.
- **Show received files** lists statistics on received files.

Sharing Pictures and Video

Before attempting to transfer files, make sure the receiving Bluetooth device is in range of the terminal and set to be discoverable by other devices. Depending on the operating system of the receiving device, you may also need to set the device to receive incoming beams.

1. Verify the Bluetooth radio is enabled. See [Turning the Bluetooth Radio On or Off](#) on page 7-1.
2. Touch **All Apps**  > **Gallery** .
3. Touch the album that contains the picture or video you want to share.
4. Select a picture or video from the thumbnail gallery, and then touch the share icon  in the upper right corner of the screen.
5. Press the **Menu** button then **Select item** to touch multiple pictures or videos you want to share.
6. Touch **Bluetooth**.
7. The **Bluetooth device picker** screen opens. Do one of the following:
 - Touch **Scan for devices**, and then touch the name of the receiving device from the available device list.
 - OR
 - Touch on the name of an already paired device from the Bluetooth device list.
8. A pop-up message notifies you the file is **Sending** and the upload notification icon  appears on the status bar.
9. Accept the file transfer on the receiving device. The acceptance procedure depends on the device's OS and security protocols.
10. If the device is another Android device, a Bluetooth incoming file notification icon  appears on the status bar. Drag down the **Notification panel**, and then touch on the **Bluetooth Incoming file notification**.
11. Touch **Accept** to allow the file transfer.
12. A pop-up message notifies you the device is downloading the file and the file location. The download notification icon  appears on the status bar.
13. Drag down the **Notification panel** on either device, to verify if the file transfer was complete.

Near Field Communication (NFC) Technology

NFC technology provides the ability for short-range, wireless data transfer between the terminal and NFC tags or other NFC enabled devices placed in close proximity to the back of the terminal. NFC equipped Dolphin 75e models support the following modes of operation:

- **NFC tag reader/writer mode**
The terminal reads and/or writes digital information from or to an NFC tag.
- **Peer-to-Peer (P2P) mode**
The terminal uses Android Beam and/or Bluetooth technology to transfer screen content (e.g., a picture, contact information, Web page url, or file) between NFC enabled devices.
- **NFC card emulation mode**
The terminal emulates an NFC card (smart card) that an external card reader can access. You have the option to enable the embedded secure element (eSE) SmartMX™ or Host Emulation. Secure element implementation is commonly used for financial transactions or coupon and loyalty mobile marketing applications that require a secure memory and execution environment for the storage of personal information (e.g., account information and credentials) and/or running custom smart card applets.

Note: Sleep mode (Suspend mode) and the screen lock temporarily turns the NFC radio off.

Hardware Requirements



NFC functionality is hardware dependent and only available on Dolphin 75e models ending with the letter N (e.g., 70exxN). Use only NFC compatible replacement battery doors with NFC equipped Dolphin models.

Security Recommendation

NFC functionality is enabled by default on Dolphin 75e models ending with the letter N (e.g., 75exxN). The recommended setting for NFC functionality is disabled until the feature is required. Enabling NFC allows data exchanges between the terminal and other NFC devices or tags.



NFC Settings

Enabling or Disabling NFC Functionality



1. Touch **All Apps**  > **Settings** .
2. Under **Wireless & Networks**, touch **More**.
3. Touch the box next to **NFC** to either enable (check) or disable (not checked) short-range wireless data exchange.

Enabling the Android Beam

Android Beam functionality is only available if NFC is enabled.

1. Touch **All Apps**  > **Settings** .
2. Under **Wireless & Networks**, touch **More**.
3. Verify the box next to **NFC** is checked (enabled).
4. Check the box next to **Android Beam**.

Selecting the Card Emulation Mode

1. Touch **All Apps**  > **Settings** .
2. Under **Wireless & Networks**, touch **More**.
3. Verify the box next to **NFC** is checked (enabled).
4. Touch **Card emulation route mode**.
5. Select either **Host Card Emulation** or **Embedded Secure Element**.

Note: Select Embedded Secure Element for reading MIFARE® Classic tags.

Reading NFC Tags

1. Verify **NFC** is enabled (see page 7-3).
2. If reading MIFARE Classic tags, verify **Embedded Secure Element** is selected as the Card emulation route mode (see page 7-3).
3. Hold the NFC tag close to the back of the terminal. When an NFC tag is recognized, the terminal emits a sound and the tag data displays on the terminal screen.

Note: The terminal must be unlocked for NFC tag detection. If sound is muted, the terminal vibrates when an NFC tag is detected.

See page 7-4 for information on [Using the NFC Demos](#).

Transferring screen content via NFC

1. Verify **NFC** is enabled (see page 7-3).
2. Verify **Android beam** is enabled on the sending terminal.
3. Open the item you want to share (e.g., contact, picture, or Web page).
4. Hold the terminals back to back. The sending terminal emits a sound, the screen image shrinks, and the message, “Touch to beam” displays.
5. Both terminals must be unlocked for NFC tag detection. If sound is muted, the terminal vibrates when an NFC tag is detected.
6. Touch the reduced screen image to initiate the transfer. The receiving terminal displays the transferred content.

Note: If an active network connection is present, Android Market™ opens if the item received requires an app not installed on the device.



Using the NFC Demos

Honeywell NFC Demos demonstrate the basic NFC capabilities of the terminal and are not intended as a functional business solution. Detailed information on how to create custom applications for your Dolphin terminal is provided in the *Software Development Kit (SDK)*, available for download at www.honeywellaidc.com.



Note: Honeywell NFC Demo are designed for use with NFC equipped Dolphin 75e models only. Before using the demos, you must enable NFC functionality on the terminal (see page 7-3).

NFC Tag Demo



The **NFC Tag Demo** demonstrates basic NFC tag reading and writing using the terminal. Three options are available under the demo: **Read a tag**, **Write a contact**, and **Write a message**. **Read a tag** demonstrates how the terminal reads and displays data from NFC tags placed in close proximity to the back of the terminal. **Write a contact** and **Write a message** demonstrates how you can write (save) data to a writable or rewritable NFC tag. The data is then displayed whenever the NFC tag is read.

Touch **All Apps**  > **Demos** . Swipe right to scroll to **NFC Demos**, and then touch  to open the demo.



To **Read a tag**:

1. Touch **NFC Tag Demo**  from inside the **NFC Demos**  app.
2. Touch **Read a tag** .
3. Hold the NFC tag close to the back of the terminal. An “NFC Tag Detected” notification displays on the screen with the raw data contained in the tag. The terminal must be unlocked for NFC tag detection.

To **Write a contact** on an NFC tag:

1. Touch **NFC Tag Demo**  from inside the **NFC Demos**  app.
2. Touch **Write a contact** .
3. Select a contact from your saved contacts list.
4. Hold the writable or rewritable NFC tag close to the back of the terminal. A “Write successful” popup message displays on the screen.





To **Write a message** on an NFC tag:

1. Touch **NFC Tag Demo**  from inside the **NFC Demos**  app.
2. Touch **Write a message** .
3. Input the message, and then select **Write**.
4. Hold the writable or rewritable NFC tag close to the back of the terminal. A “Write successful” popup message displays on the screen.

NFC Bluetooth

NFC Bluetooth demo demonstrates how NFC in conjunction with Bluetooth technology can facilitate the transfer of a file between two devices.

Note: The NFC Bluetooth Demo is for use with Dolphin 75e terminals only.

1. Verify **NFC** technology is enabled on both terminals.
2. Verify **Android beam** is enabled on the terminal sending the file.
3. Touch **NFC Bluetooth**  from inside the **NFC Demos**  app on the sending terminal. The NFC Bluetooth demo automatically enables Bluetooth technology on both terminals during the demo process.
4. Touch **Select**.
5. Choose to browse either the **Gallery**  or **Drive**  for the file. A Google account is required for Google Drive™ online storage service. Additional fees may apply.
6. Touch the file name or picture thumbnail to send. Once a file is selected, the NFC Bluetooth app screen displays a brief pop-up message to “Ensure devices are near for beaming.” You do not need to touch “Select” again if the picture or file appears on the screen.
7. Hold the terminals back to back. The sending terminal emits a sound, the screen image shrinks, and the message, “Touch to beam” displays. Both terminals must be unlocked to for NFC detection. If sound is muted, the terminal vibrates when an NFC tag is detected.
8. Touch the reduced screen image. The terminal automatically initiates a Bluetooth pairing. Once pairing is complete, the file is sent.



The file image and saved location are displayed on the receiving terminal screen when the transfer is successful. By default, the file is saved to the root Honeywell/nfcbt-demo folder of the microSD card.

9. Select the **Back** button  to exit the demo. The NFC Bluetooth demo automatically disables Bluetooth technology when the demo is closed.

NFC Beam Demo

NFC Beam Demo demonstrates how a file can be transmitted between two devices using the Android beam.

Note: The NFC Bluetooth Demo is for use with Dolphin 75e terminals only.

-
1. Verify **NFC** technology is enabled on both terminals.
 2. Verify **Android beam** is enabled on the terminal sending the file.
 3. Touch **NFC Beam Demo**  from inside the **NFC Demos**  app on the sending terminal.
 4. Check the box next to the **test.txt** file.
 5. Hold the terminals back to back. The sending terminal emits a sound, the demo screen image shrinks, and the message, "Touch to beam" displays.

Note: Both terminals must be unlocked for NFC detection. If sound is muted, the terminal vibrates when an NFC tag is detected.

6. Touch the reduced screen image to initiate file transfer.

A "File received" message is displayed on the receiving terminal when the transfer is successful. By default, the file is saved to the root Honeywell/nfcbeamdemo folder of the microSD card.

7. Select the **Back** button  to exit the demo.

Dolphin 70e Black HomeBase (Model 70e-HB)

Overview

The Dolphin 70e Black HomeBase (Model 70e-HB) is a charging and communication cradle that supports USB Hi-Speed 2.0v communication, which enables the terminal to interface with the majority of PC-based enterprise systems. The HomeBase also contains an auxiliary battery well that charges a spare Honeywell standard or extended battery.

The 70e-HB charger is designed for use with the following Dolphin models and batteries manufactured for Honeywell International Inc:

| Dolphin Models | Battery Model No. | Battery Part No. | Battery Specification |
|----------------------------|-------------------|------------------|-------------------------------|
| Dolphin 75e Dolphin 70e | 70e-BTSC | BAT-STANDARD-02 | Li-ion 3.7V, 6.179 watt hour |
| | 70e-BTEC | BAT-EXTENDED-02 | Li-ion 3.7V, 12.358 watt hour |



We recommend use of Honeywell peripherals, power cables, and power adapters. Use of any non-Honeywell peripherals, cables, or power adapters may cause damage not covered by the warranty.

Unpacking the HomeBase

Open the shipping box and inspect the package to see that the following standard items are included:

- One Dolphin HomeBase, model 70e-HB
- One power supply (see [Power](#) on page 8-4)
- One power cord

These items are needed to operate the HomeBase. If any items are missing or anything appears to be damaged, contact your Customer Account Representative. Keep the original packaging in case you need to return the HomeBase for service or to store the HomeBase while not in use.

Optional Equipment

A standard USB (Type A to B) cable is required when using the HomeBase for communication between the terminal and a host device.

Charging Overview

The base provides power to the intelligent battery charging system in all Dolphin terminals that senses when a full charge has been achieved and switches to a trickle charge to maintain the full charge. The base completes a full charge of the main battery installed in the terminal seated in the terminal well in 4 hours for the standard battery or 6 hours for the extended battery. The base completes a full charge of the battery pack in the [Auxiliary Battery Well](#) (see page 8-3) in 4 hours for the standard battery or 6 hours for the extended battery.

Note: Before attempting to use, charge, or replace the battery in the terminal, you should read the [Guidelines for Battery Pack Use and Disposal](#) on page 2-12.



We recommend use of Honeywell Li-ion battery packs. Use of any non-Honeywell battery may result in damage not covered by the warranty.

Convenient Storage

The intelligent battery charging system makes this base a safe and convenient storage receptacle for your Dolphin terminal.

Capacity

The base holds one terminal and features an auxiliary battery well behind the terminal well that can charge a battery pack independently of the terminal well. This means that one base can charge two battery packs: the one installed in the terminal and a spare.



We recommend use of Honeywell peripherals, power cables, and power adapters. Use of any non-Honeywell peripherals, cables, or power adapters may cause damage not covered by the warranty.

Dimensions

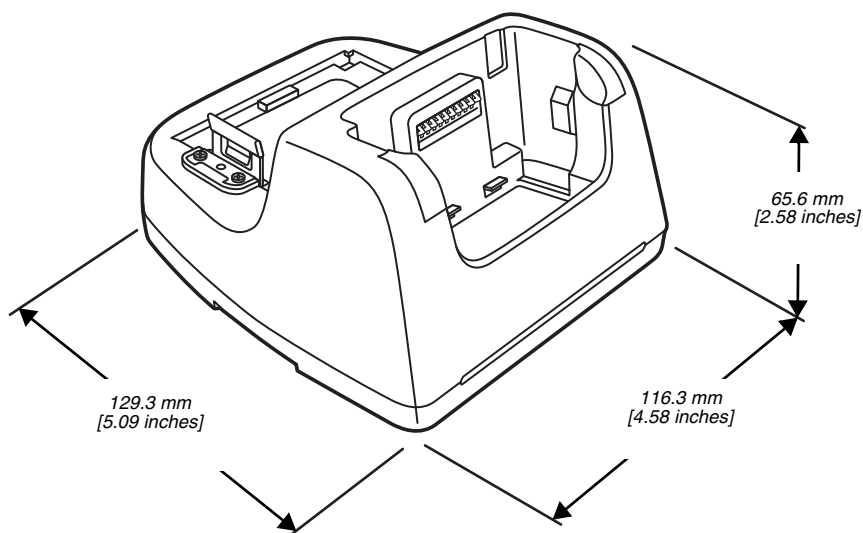

Weight

HomeBase weight: 303g [.668 lbs]

Note: Weight excludes packaging, cables and power supply.

Parts and Functions

Front Panel

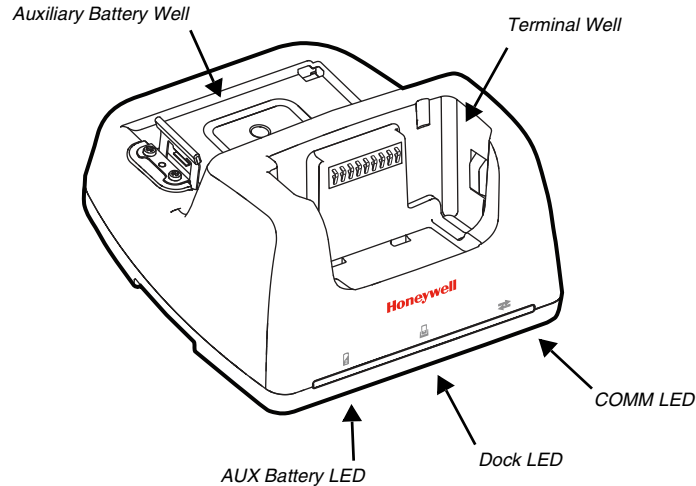

Terminal Well

Place the terminal in this well to communicate with a host device, power the terminal, and charge the installed battery pack. The base completely charges the main battery in a Dolphin terminal in 4 hours for the standard battery or 6 hours for the extended battery. See [page 8-6](#) for information on [USB Communication](#) between the host and terminal via the HomeBase.

Auxiliary Battery Well

See "Auxiliary Battery Well" on page 8-4

AUX Battery LED

Indicates status of the battery charging in the auxiliary battery well; see [Back Panel](#) on page 8-4.

| This color | means... |
|---------------|--|
| Orange | The auxiliary battery is charging. |
| Green | The auxiliary battery has completed charging and is ready for use. |

For information about charging a battery in the auxiliary battery well, see page 8-5.

Dock LED

Indicates if a terminal is docked properly in the base.

| This color | means... |
|-------------|--|
| Blue | The terminal is properly seated in the base. |

COMM LED

This is the communication LED. It indicates the status of data transfer between the Dolphin terminal and the host device.

| This color | means... |
|--------------|--|
| Green | A USB Connection is established with the host workstation. |

Back Panel

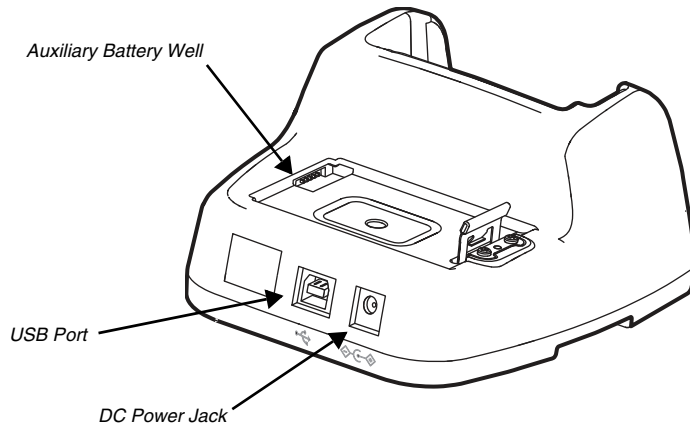

Auxiliary Battery Well

The base enables you to charge an additional battery pack independently of the terminal well in 4 hours for the standard battery or 6 hours for the extended battery. This feature ensures that you can always have a fully-charged battery for your terminal. See [Charging a Spare Battery in the Auxiliary Battery Well](#) on page 8-5.

USB Port

This USB port is USB v2.0 Hi-Speed (480 Mbps) compliant. Using a USB cable, you can connect the base to a host device, such as a workstation. When the terminal is seated in the terminal well, it is connected to the host device via the base. See [Communication](#) on page 8-6.

DC Power Jack

See [Power](#) on page 8-4.

Bottom Panel

For details on how to mount the HomeBase, see [Mounting the HomeBase](#) on page 8-6.

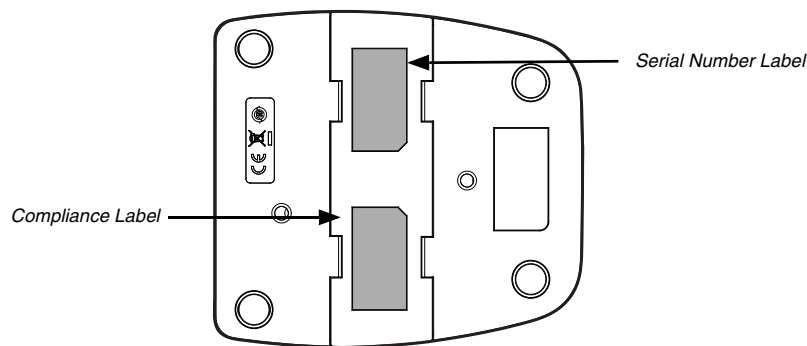

Power

The base requires 12 Volts DC input for communications, battery charging, and power output to the terminal. The power adapter included with the base, converts the voltage from the AC power source to 12 Volts DC. **Use only a UL listed power supply, which has been qualified by Honeywell with output rated at 12VDC and 3 amps with the device.** The operating temperature range is -10° to 50°C (14° to 122°F). Honeywell recommends that you leave the base connected to its power source at all times, so that it is always ready to use.



We recommend use of Honeywell peripherals, power cables, and power adapters. Use of any non-Honeywell peripherals, cables, or power adapters may cause damage not covered by the warranty.

Connecting Power to the HomeBase

1. Plug the A/C power cord into the power adapter.
2. Plug the power cable into the power connector on the back of the HomeBase.
3. Plug the A/C power cord into a grounded power source.
4. The base is now powered.

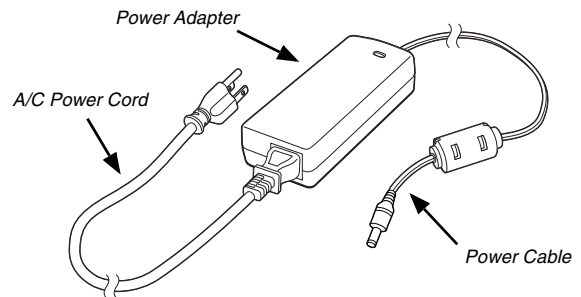

Charging the Main Battery

The base provides power to the Dolphin terminal and allows the charging of the terminal's battery. The intelligent battery charging system incorporated into all Dolphin terminals prevents overcharging, which means that Dolphin terminals may be stored in the base indefinitely without damage to the terminals, battery, or the base. When the terminal is docked, the base completes a full charge in 4 hours for the standard battery or 6 hours for the extended battery.



For more information about Honeywell battery packs and how to check battery power levels in your terminal, refer to [Battery](#) (page 2-9).

To Power a Terminal and Charge its Main Battery



Ensure all components are dry prior to mating terminals/batteries with peripheral devices. Mating wet components may cause damage not covered by the warranty.

1. Install the battery pack in the terminal; see [Install the Battery](#) on page 1-1.
2. Slide the terminal into the terminal well. The Dock LED illuminates blue. Battery charging begins immediately if required by the Dolphin terminal.

Note: When the terminal is docked, the Battery Icon changes from  to  indicating the terminal is running on external power. Battery charging occurs in the background. When the Dolphin is removed from the base, the battery icon indicates the charge level of the battery, see [Common Status and Notification Icons](#) on page 1-7.

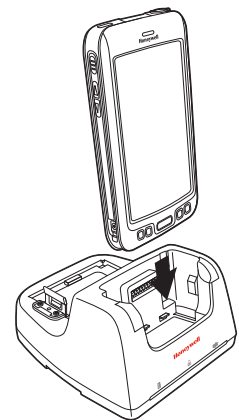

We recommend use of Honeywell Li-Ion battery packs. Use of any non-Honeywell battery may result in damage not covered by the warranty.

Charging a Spare Battery in the Auxiliary Battery Well

The auxiliary battery well located on the back of the base charges a spare battery independently of the terminal well. The Aux Battery LED on the front panel indicates the status of the battery in this well. Charge time is 4 hours for the standard battery pack or 6 hours for the extended battery pack; see [Auxiliary Battery Well](#) on page 8-4.

1. Insert the battery at an angle.

Note: Align the battery contacts with the contacts inside the auxiliary battery well.

2. Snap the battery into place with a hinging motion. The Aux Battery LED lights orange during charging.
3. Use the AUX Battery LED to monitor the charging progress. The LED changes to green when the auxiliary battery has completed charging and is ready for use.

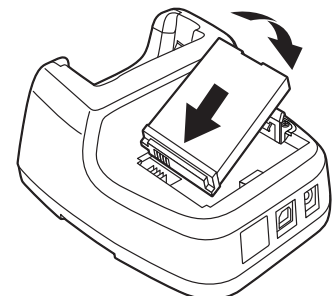

Communication

Dolphin terminals support USB communications out of the box. The base also supports USB communications via the USB port located on the back. The base acts as a USB device by interfacing the USB signals of the Dolphin terminal to the USB of the host workstation. Using a standard USB cable, the base's USB interface allows the Dolphin terminal to communicate with a workstation.

Note: This base cannot be daisy-chained.

Requirements



- A base powered by a power cable and power adapter cable
- A standard USB (Type A to B) communication cable
- A work station running Windows XP, Windows Vista, or Windows 7.

Establishing USB Communication



1. Connect power to the HomeBase (see [Power](#) on page 8-4).
2. Plug the USB communication cable into the USB port on the back of the base.

Note: The Dolphin terminal should always be removed from the HomeBase when connecting or disconnecting the USB cable.

3. Connect the other end of the USB cable to the host workstation.
4. Insert the Dolphin terminal into the terminal well of the base. The Dock LED illuminates blue.
5. If a USB connection automatically establishes, a notification briefly appears at the top of the screen on the terminal:

 Connected as a media device or  Connected as a camera.

If a USB connection does not automatically establish:

- a. Touch **All Apps**  > **Settings**  > **Storage**.
 - b. Touch **More** , and then **USB computer connection**.
 - c. Select either **Connected as a media device (MTP)** or **Camera (PTP)**. Your selection is stored as the default but is easy to change by accessing the Notification panel. Swipe down from the Status/Notification bar at the top of the screen to view USB connection details and change the type.
4. You can now copy, delete and/or move files or folders between the computer and the terminal or the microSD card installed in the terminal as you would with any other storage drive (e.g., cut and paste or drag and drop).

*Note: When you connect as a **Camera (PTP)** only the DCIM and Pictures Folders from the Internal Storage show in File Explorer or Windows Explorer.*

Mounting the HomeBase

Set the base on a dry, stable surface, such as a desktop or workbench near an electrical outlet. The user should be able to view and operate the Dolphin terminal while it is in the base. When choosing a mounting location, bear in mind that the location must allow users' easy access to the Auxiliary Battery Well and the back panel of the HomeBase where the USB port and the power jack are located.

Optional DIN Rail Mount

A DIN rail (7.5 X 35 mm) may be installed on the bottom of the base to provide the optional security of mounting the base to a flat horizontal surface with hardware.

Additional Hardware

- DIN Rail, Qty. 1
- 3/16 in. dia x 5/8 in. long pan head screw, Qty. 2
- 1/2 in. OD x 7/32 in. ID x 3/64 in. thick washer, Qty. 4

-
- 3/16 in. dia nut, Qty. 2

Note: The items listed are for reference only. Final hardware selection is dependent on the material type and thickness of the mounting surface.

Installing the DIN Rail

1. Slide the DIN rail into the slot along the bottom panel of the base.

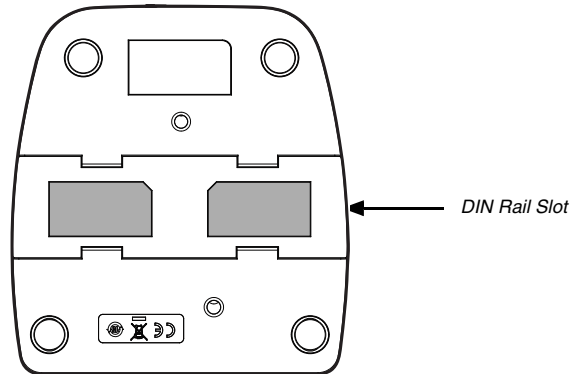

2. Use the appropriate hardware to secure the DIN rail to the desk or flat surface.

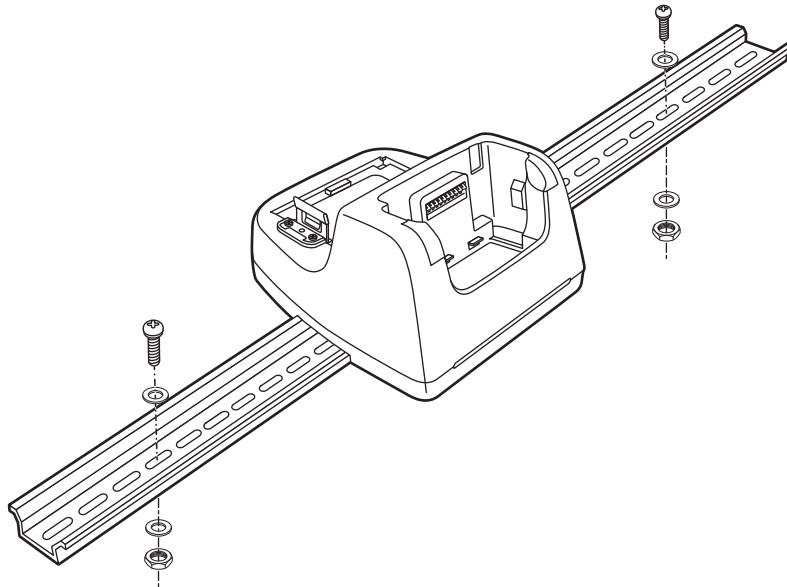



Dolphin 70e Black eBase (Model 70e-EHB)

Overview

The Ethernet Base (eBase) enables a single Dolphin 75e computer to communicate with a host device over an Ethernet network. The 70e-EHB charger is designed for use with the following Dolphin models and batteries, manufactured for Honeywell International Inc:

| Dolphin Models | Battery Model No. | Battery Part No. | Battery Specification |
|----------------------------|-------------------|------------------|-------------------------------|
| Dolphin 75e Dolphin 70e | 70e-BTSC | BAT-STANDARD-02 | Li-ion 3.7V, 6.179 watt hour |
| | 70e-BTEC | BAT-EXTENDED-02 | Li-ion 3.7V, 12.358 watt hour |



We recommend use of Honeywell peripherals, power cables, and power adapters. Use of any non-Honeywell peripherals, cables, or power adapters may cause damage not covered by the warranty.

Unpacking the eBase

Open the shipping box and inspect the package to see that the following standard items are included:

- One Dolphin eBase Ethernet cradle, model 70e-EHB
- One power supply (see [Power](#) on page 9-4)
- One power cord

These items are needed to set up and operate the eBase. If any items are missing or anything appears to be damaged, contact your Customer Account Representative. Keep the original packaging in case you need to return the eBase for service or to store the eBase while not in use.

Optional Equipment

- A standard USB (Type A to B) cable is required when using the eBase for USB communication between the terminal and a host device.
- A standard CAT-5 Ethernet network cable is required when using the eBase for communication between the terminal and a host device over an Ethernet network.

Charging Overview

The base provides power to the intelligent battery charging system in all Dolphin terminals that senses when a full charge has been achieved and switches to a trickle charge to maintain the full charge. The base completes a full charge of the main battery pack installed in the terminal seated in the terminal well in 4 hours for the standard battery or 6 hours for the extended battery. The base completes a full charge of the battery pack in the [Auxiliary Battery Well](#) (see page 9-3) in 4 hours for the standard battery or 6 hours for the extended battery.

Note: Before attempting to use, charge, or replace the battery in the terminal, you should read the [Guidelines for Battery Pack Use and Disposal](#) on page 2-12.



We recommend use of Honeywell Li-ion battery packs. Use of any non-Honeywell battery may result in damage not covered by the warranty.

Convenient Storage

The intelligent battery charging system makes this base a safe and convenient storage receptacle for your Dolphin terminal.

Capacity

The base holds one terminal and features an auxiliary battery well behind the terminal well that can charge a battery pack independently of the terminal well. This means that one base can charge two battery packs: the one installed in the terminal and a spare.

Dimensions

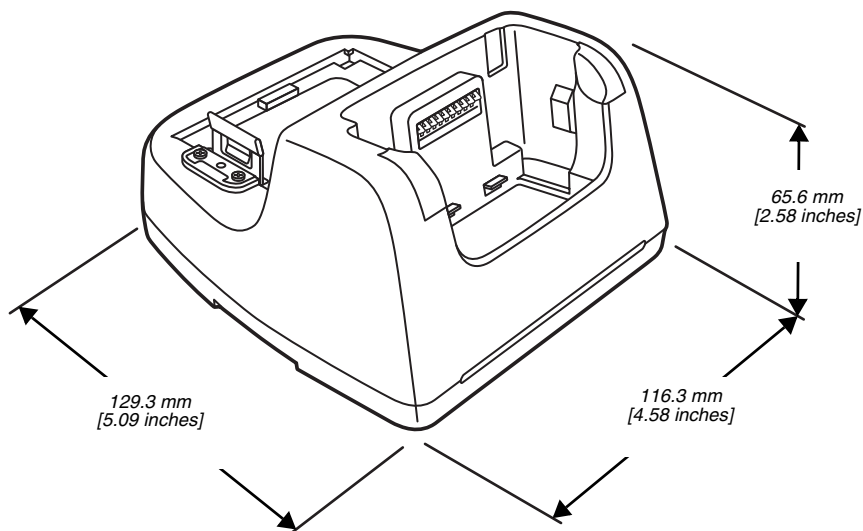

Weight

eBase weight: 310g [.683 lbs]

Note: Weight excludes packaging, cables and power supply.

Parts and Functions

Front Panel

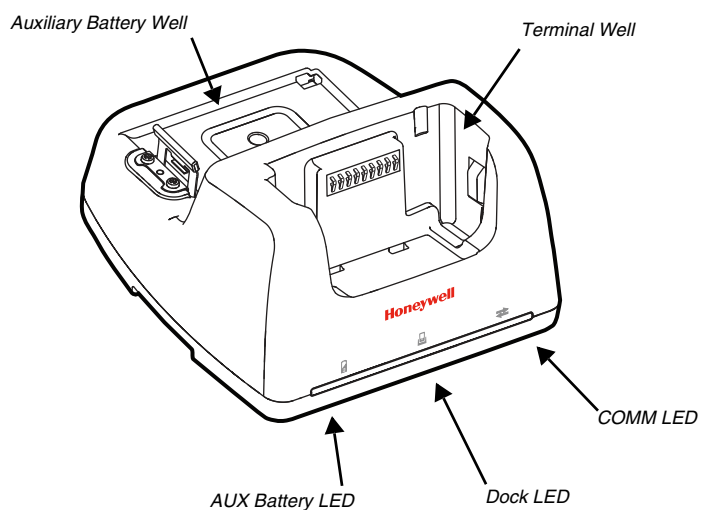

Terminal Well

Place the terminal in this well to communicate with a host device, power the terminal, and charge the installed battery pack. The eBase completely charges the main battery in a Dolphin terminal in 4 hours for the standard battery or 6 hours for the extended battery.

Auxiliary Battery Well

See "Auxiliary Battery Well" on page 9-3

AUX Battery LED

Indicates status of the battery charging in the auxiliary battery well; see [Back Panel](#) on page 9-3.

| This color | means... |
|---------------|--|
| Orange | The auxiliary battery is charging. |
| Green | The auxiliary battery has completed charging and is ready for use. |

For information about charging a battery in the auxiliary battery well, see page 9-5.

Dock LED

Indicates if a terminal is docked properly in the base.

| This color | means... |
|-------------|--|
| Blue | The terminal is properly seated in the base. |

COMM LED

Indicates the status of the connection and data transfer between the Dolphin terminal and the host device.

| This color | means... |
|--------------|--|
| Green | A USB Connection is established with the host workstation. |

Note: Ethernet activity is indicated by RJ45 integrated LED on the back panel of the base.

Back Panel

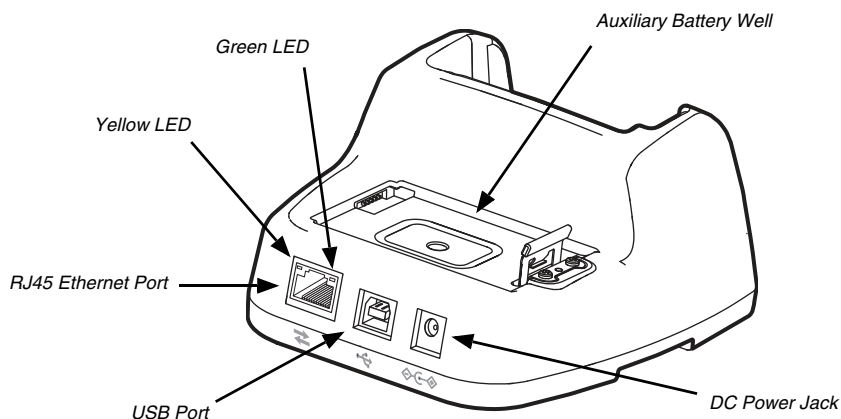

Auxiliary Battery Well

The eBase enables you to charge an additional battery pack independently of the terminal well in 4 hours for the standard battery or 6 hours for the extended battery. This feature ensures that you can always have a fully charged battery for your terminal.

USB Port

This USB port is USB v2.0 Hi-Speed (480 Mbps) compliant. Using a USB cable, you can connect the base to a host device, such as a workstation (PC). When the terminal is seated in the terminal well, it is connected to the host device via the base.

RJ45 Ethernet Port

Use a standard CAT-5 Ethernet cable; you can connect the ebase to an Ethernet-compliant device to facilitate Ethernet communication to and from the terminal. The RJ45 connector includes integrated LEDs that provide Ethernet communication status and speed information.

| Status | Yellow LED | Green LED |
|---|---|-----------|
| No Ethernet Link | Off | Off |
| 10Mbps Ethernet Connection Established | Off | On |
| 100Mbps Ethernet Connection Established | On | On |
| Data transfer in progress | Connection Speed Dependent (see above) | Flashing |

DC Power Jack

This connector receives input from the power adapter. Plug the power connector cable from the power adapter into this connector, see [Power](#).

Bottom Panel

For details on how to mount the eBase, see [Mounting the eBase](#) on page 9-7.

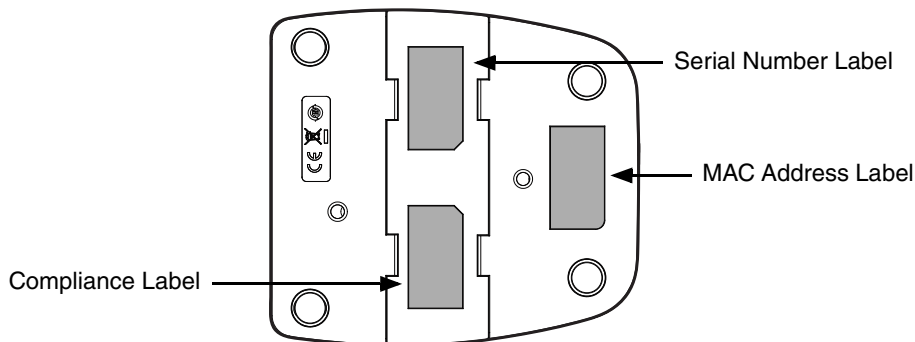

Power

The base requires 12 Volts DC input for communications, battery charging, and power output to the terminal; the power adapter included with the base converts the voltage from the AC power source to 12 Volts DC. **Use only a UL listed power supply, which has been qualified by Honeywell with output rated at 12VDC and 3 amps with the device.** The operating temperature range is -10° to 50°C (14° to 122°F). Honeywell recommends that you leave the eBase connected to its power source at all times, so that it is always ready to use.



We recommend use of Honeywell peripherals, power cables, and power adapters. Use of any non-Honeywell peripherals, cables, or power adapters may cause damage not covered by the warranty.

Connecting Power to the eBase

1. Plug the A/C power cord into the power adapter.
2. Plug the power cable into the power connector on the back of the eBase.
3. Plug the A/C power cord into a grounded power source.

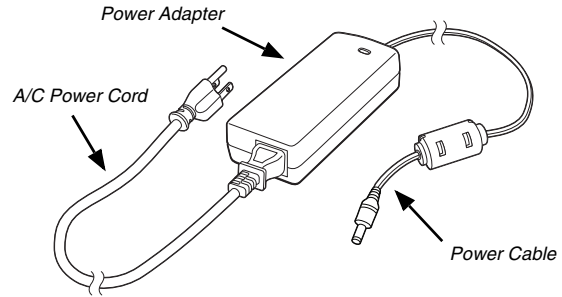

Charging the Main Battery

The base provides power to the Dolphin terminal and allows the charging of the terminal's battery. The intelligent battery charging system incorporated into all Dolphin terminals prevents overcharging, which means that Dolphin terminals may be stored in the base indefinitely without damage to the terminals, battery packs, or the base. When the terminal is docked, the base completes a full charge in 4 hours for the standard battery or 6 hours for the extended battery.



For more information about Honeywell battery packs and how to check battery power levels in your terminal, refer to [Battery](#) (page 2-9).

To Power a Terminal and Charge its Main Battery



Ensure all components are dry prior to mating terminals/batteries with peripheral devices. Mating wet components may cause damage not covered by the warranty.

1. Install the battery pack in the terminal; [see page 1-1](#).
2. Slide the terminal into the terminal well. The Dock LED illuminates blue. Battery charging begins immediately if required by the Dolphin terminal.

Note: When the terminal is docked, the Battery Icon changes from  to  indicating the terminal is running on external power. Battery charging occurs in the background. When the Dolphin is removed from the base, the battery icon indicates the charge level of the battery, see [Common Status and Notification Icons](#) on page 1-7.



We recommend use of Honeywell Li-Ion battery packs. Use of any non-Honeywell battery may result in damage not covered by the warranty.

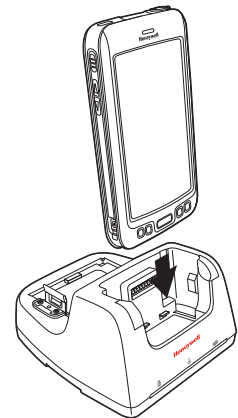

Charging a Spare Battery in the Auxiliary Battery Well

The auxiliary battery well located on the back of the base charges a spare battery independently of the terminal well. The Aux Battery LED on the front panel indicates the status of the battery in this well. Charge time is 4 hours for the standard battery pack or 6 hours for the extended battery pack; see [Auxiliary Battery Well](#) on page 9-3.

1. Insert the battery at an angle.

Note: Align the battery contacts with the contacts inside the auxiliary battery well.

2. Snap the battery into place with a hinging motion. The Aux Battery LED lights orange during charging.
3. Use the AUX Battery LED to monitor the charging progress. The LED lights green when the auxiliary battery has completed charging and is ready for use.

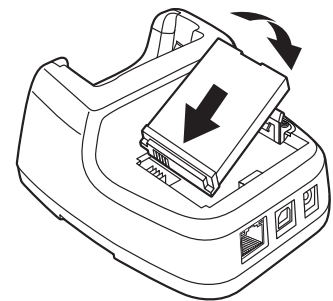





Communication

Establishing Ethernet Communication

Connecting the Dolphin Terminal to the eBase

By default, the Dolphin terminal is configured to obtain IP addresses automatically via DHCP server. This means that in most cases you would simply plug-and-play the unit.



1. Connect power to the eBase (see [Power](#) on page 9-4).
2. Plug the CAT-5 Ethernet cable into the RJ45 connector on the back of the eBase.
3. Plug the Ethernet cable into the network.
4. Insert the Dolphin into the terminal well. The Dock LED on the base illuminates blue.
5. Touch **All Apps**  > **Settings**  > **Ethernet configuration**.
6. Check the box to **Turn on Ethernet**. When an Ethernet connection is established the status icon changes from  to  at the top of the screen.

Troubleshooting

If the items on the Ethernet configuration screen are grayed out and not accessible, verify the base has power, the Ethernet cable is undamaged and properly installed to the base, there is an active network signal over the Ethernet cable, and the terminal is properly docked in the base.



Ethernet Configuration Settings

Instead of using the default DHCP assigned IP address, the Dolphin terminal can be configured to use a statically assigned IP address.

1. Touch **All Apps**  > **Settings**  > **Ethernet configuration**.
2. Select **Ethernet configuration**, again.
3. Select **Static IP** under Connection Type, and then input the **IP address** and any additional information based on your network configuration.
4. Touch **Save**.

Ethernet Proxy Settings

To set up a proxy to use when accessing your network with Ethernet:

1. Touch **All Apps**  > **Settings**  > **Ethernet proxy settings**.
2. Input the **Proxy host name** and **Proxy port**. If required, designate when to bypass the proxy.
3. Select **Done**.

Displaying the eBase and Terminal IP Address

Once the Dolphin terminal has been successfully connected to the network through eBase, the terminal uses the eBase IP address. The IP address can be used by any application on the Dolphin terminal.

Touch **All Apps**  > **Settings**  > **About Phone** > **Status** to view the assigned IP Address.

Establishing USB Communication

Dolphin terminals support USB communications out of the box. The base also supports USB communications via the USB port located on the back. The base acts as a USB device by interfacing the USB signals of the Dolphin terminal to the USB of the host workstation. Using a standard USB cable, the base's USB interface allows the Dolphin terminal to communicate with a workstation.

Note: This base cannot be daisy-chained.

Requirements

- A base powered by a power cable and power adapter cable
- A standard USB (Type A to B) communication cable
- A work station running Windows XP, Windows Vista, Windows 8 or Windows 7.

Setting Up and Connecting the Dolphin Terminal to an eBase

1. Connect power to the HomeBase (see [Power](#) on page 9-4).
2. Plug the USB communication cable into the USB port on the back of the base. The Dolphin terminal should always be removed from the HomeBase when connecting or disconnecting the USB cable.
3. Connect the other end of the USB cable to the host workstation.
4. Insert the Dolphin terminal into the terminal well of the base. The Dock LED illuminates blue.
5. Select either **Connected as a media device (MTP)** or **Camera (PTP)**. Your selection is stored as the default but is easy to change by accessing the Notification panel. Swipe down from the Status/Notification bar at the top of the screen to view USB connection details and change the connection type.

On the status bar, the following notification briefly appears to indicate the hardware connection has been established:

 Connected as a media device or  Connected as a camera

6. You can now copy, delete and/or move files or folders between the computer and the terminal or the microSD card installed in the terminal as you would with any other storage drive (e.g., cut and paste or drag and drop).

*Note: When you connect as a **Camera (PTP)** only the DCIM and Pictures Folders from the Internal Storage show in File Explorer or Windows Explorer.*

Mounting the eBase

Set the base on a dry, stable surface, such as a desktop or workbench near an electrical outlet. Be sure to provide enough workspace with good lighting for the user to view and operate the Dolphin terminal while it is in the base. When choosing a mounting location, bear in mind that the location must allow users' easy access to the Auxiliary Battery Well and the back panel of the eBase where the USB port, Ethernet port, and power jack are located.

Optional DIN Rail Mount

A DIN rail (7.5 X 35 mm) may be installed on the bottom of the base to provide the optional security of mounting the base to a flat horizontal surface with hardware.

Additional Hardware

- DIN Rail, Qty. 1
- 3/16 in. dia x 5/8 in. long pan head screw, Qty. 2
- 1/2 in. OD x 7/32 in. ID x 3/64 in. thick washer, Qty. 4
- 3/16 in. dia nut, Qty. 2

Note: The items listed above are for reference only. Final hardware selection is dependent on the material type and thickness of the mounting surface.

Installing the DIN Rail

1. Slide the DIN rail into the slot along the bottom panel of the base.

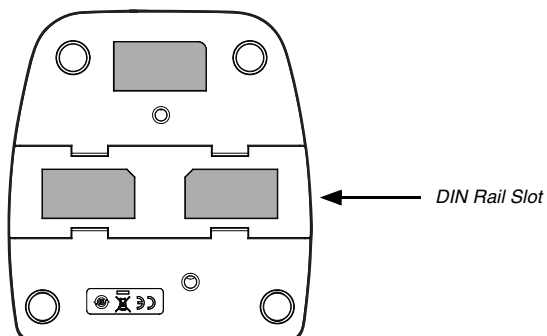

2. Use the appropriate hardware to secure the DIN rail to the desk or flat surface.

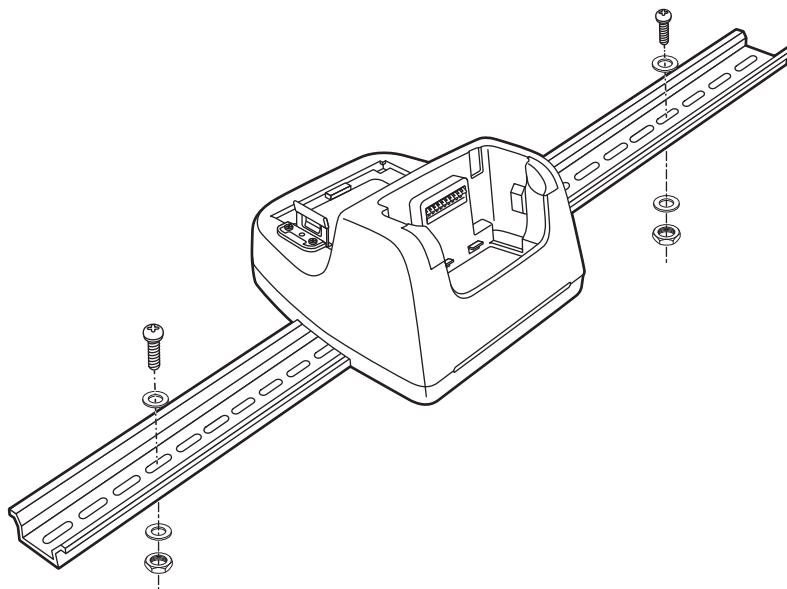

Dolphin 70e Black Mobile Base (Model 70e-MB)

Overview

The Dolphin Mobile Base charging cradle is designed specifically for in-premise and in-transit data collection applications. The base features a mounting bracket and a cigarette lighter adapter to adapt it to your environment.

The 70e-MB charger is designed for use with the following Dolphin models and batteries manufactured for Honeywell International Inc:

| Dolphin Model | Battery Model No. | Battery Part No. | Battery Specification |
|---------------|-------------------|------------------|-------------------------------|
| Dolphin 75e | 70e-BTSC | BAT-STANDARD-02 | Li-ion 3.7V, 6.179 watt hour |
| | 70e-BTEC | BAT-EXTENDED-02 | Li-ion 3.7V, 12.358 watt hour |



We recommend use of Honeywell peripherals, power cables, and power adapters. Use of any non-Honeywell peripherals, cables, or power adapters may cause damage not covered by the warranty.

Charging Overview

The base provides power to the intelligent battery charging system in all terminals that senses when a full charge has been achieved and switches to a trickle charge to maintain the full charge. The base completes a full charge of the main battery in 4 hours for the standard battery pack or 6 hours for the extended battery pack.

Note: Before attempting to use, charge, or replace the battery in the terminal, you should read the [Guidelines for Battery Pack Use and Disposal](#) on page 2-12.



We recommend use of Honeywell Li-Ion battery packs. Use of any non-Honeywell battery may result in damage not covered by the warranty.

Convenient Storage

Intelligent battery charging makes the base a safe and convenient storage receptacle for your Dolphin terminal.

Dimensions

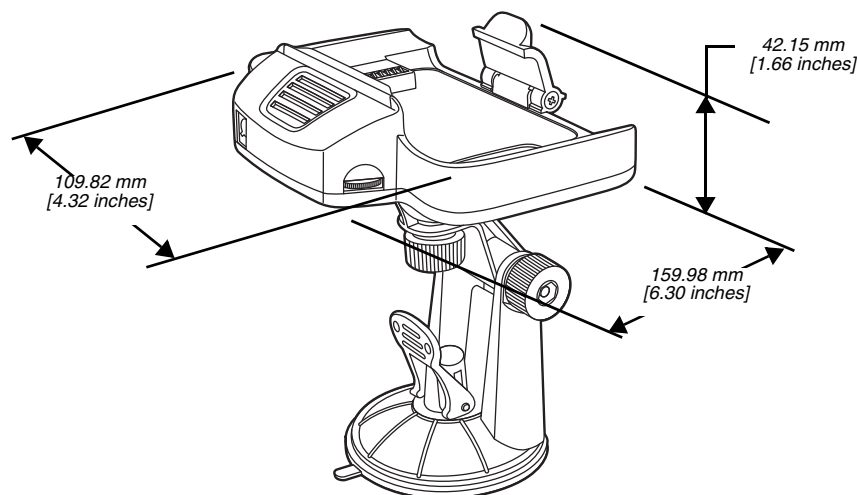

Weight

Mobile Base and adjustable arm weight: 270g [.595 lbs]

Mobile Base Components

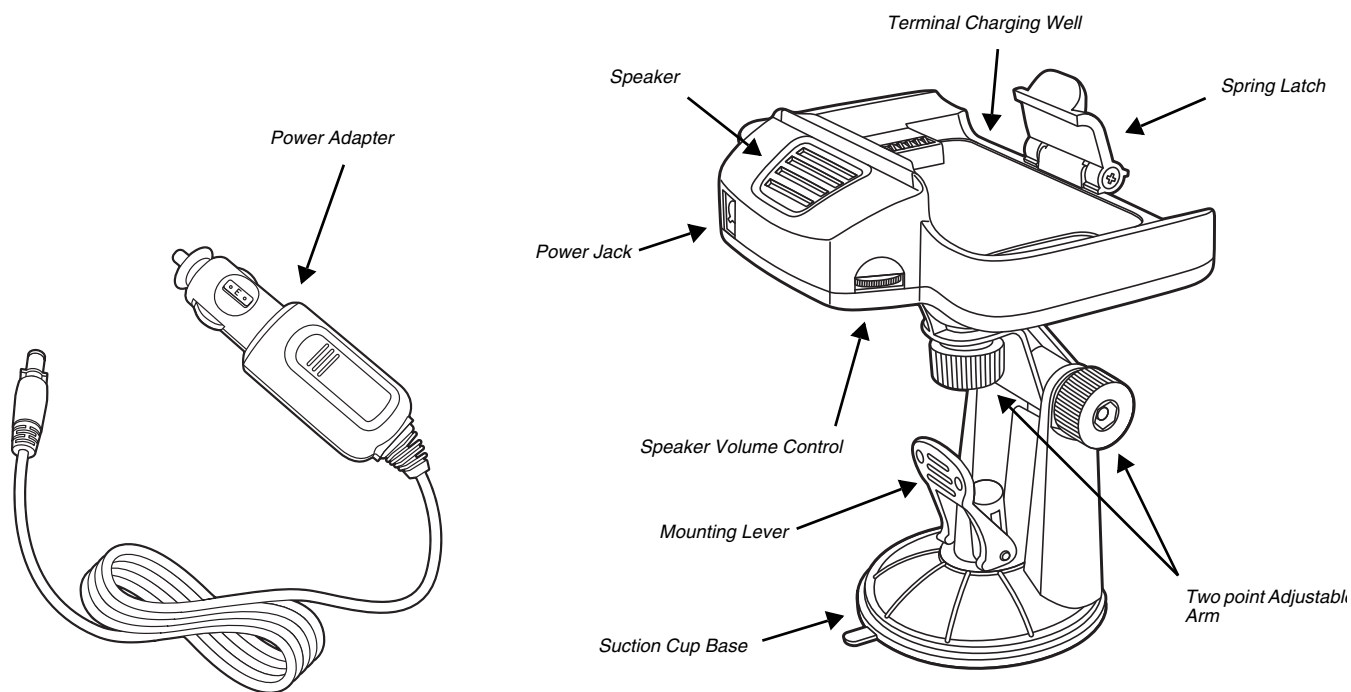

Adjustable Arm with Suction Cup Base for Windshield Mounting

The Mobile Base includes a two point adjustable arm with a suction cup base for fixed mount locations (e.g., a car windshield).

Power Adapter

The mobile base is provided with a power adapter cable that can be connected to a vehicle cigarette lighter outlet.

UL listed power supply

Input: 10V - 30VDC, 0.43A(30V) - 1.28A(10V)

Output: 4.75V - 5.25VDC, 0 - 2A



Verify that the power source is always within the specified range and observe correct input voltage polarity. An improper input voltage range or reverse polarity could damage the power conversion circuitry.

Speaker and Volume Control Dial

The integrated speaker amplifies the Dolphin terminal's audio signals and the speaker volume is adjusted using the dial located on the side of the base.

Spring Latch

The spring latch secures the terminal in the Mobile Base charging well.

Terminal Charging Well

Place the terminal in this well to charge the battery.

Mounting the Mobile Base

Safety Precautions

Honeywell is not responsible for any damages caused to you, your vehicle, or other individuals due to the installation of the Dolphin Mobile mount. Follow these safety precautions when mounting the mobile base:



Do not mount the base in a location where it prevents safe operation of the vehicle and/or impedes the vehicle operator's field of view.



Do not mount the base in a location where the connectors on the bottom panel of the base are not easily accessible. Be sure to leave enough room for unrestricted cable connections.



The Mobile base is intended for use in an enclosed space protected from the elements. Do not mount the Mobile base on external vehicle surfaces.



Do not install the Mobile base in an air bag deployment zone. Honeywell assumes no responsibility of liability for injury or death because of car crashes and/or air bag deployment.

Installation

1. Push the suction cup base firmly to the windshield.

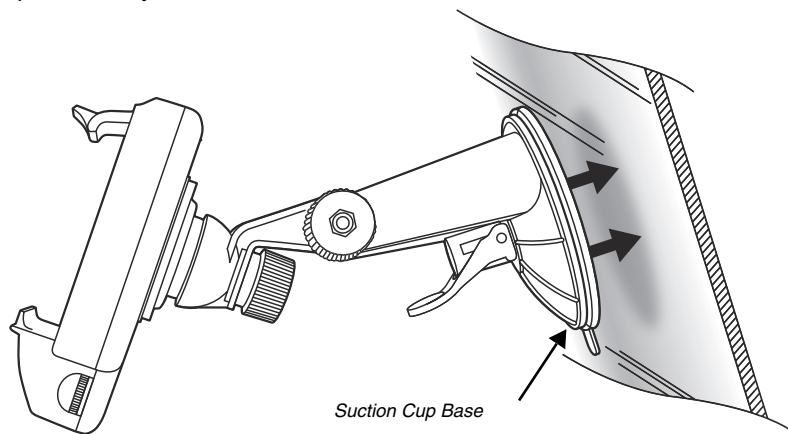

2. Flip the mounting lever down to secure the suction cup.

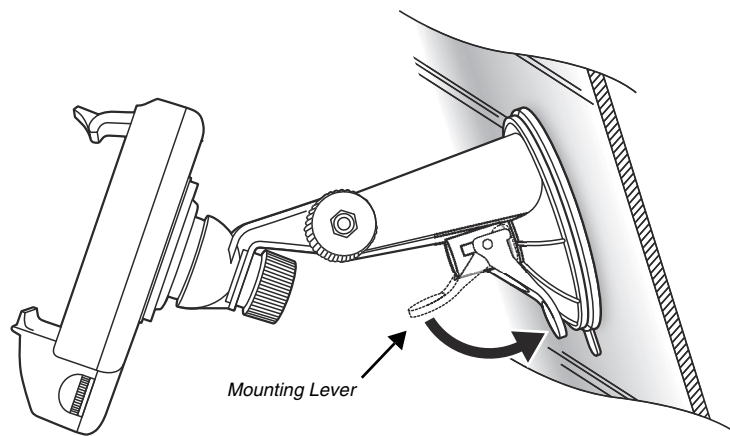

-
3. To adjust the angle of the bracket arm, twist the thumb screws counterclockwise to loosen the locks. Reposition the angle of the arm, and then twist the knobs clockwise to lock the arm into position.

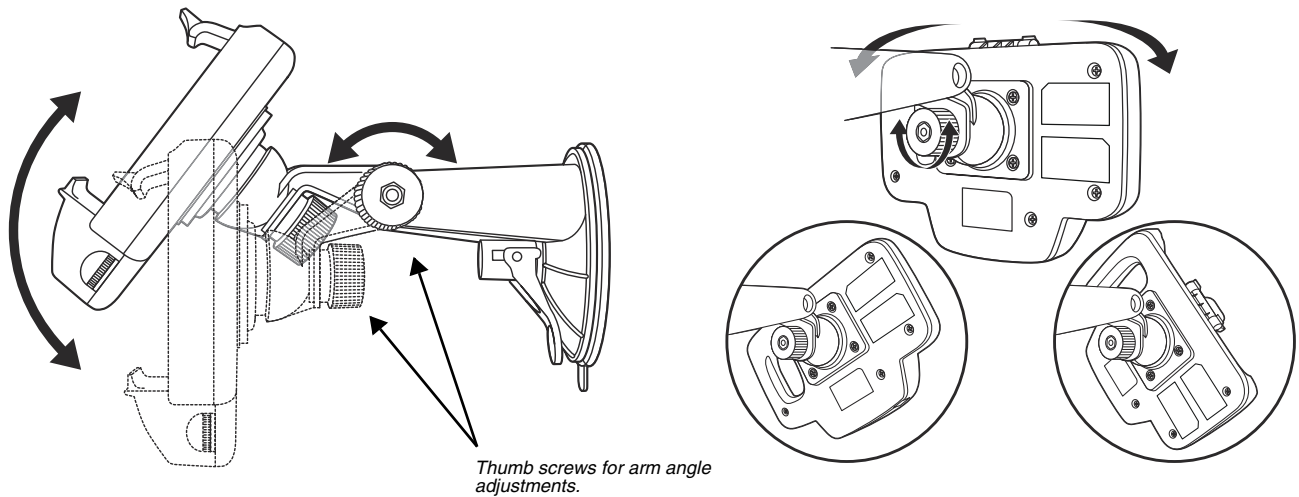

4. Insert the power cable connector into the power jack on the Mobile Base.
5. Twist the cable connector 90° clockwise to engage the cable lock.

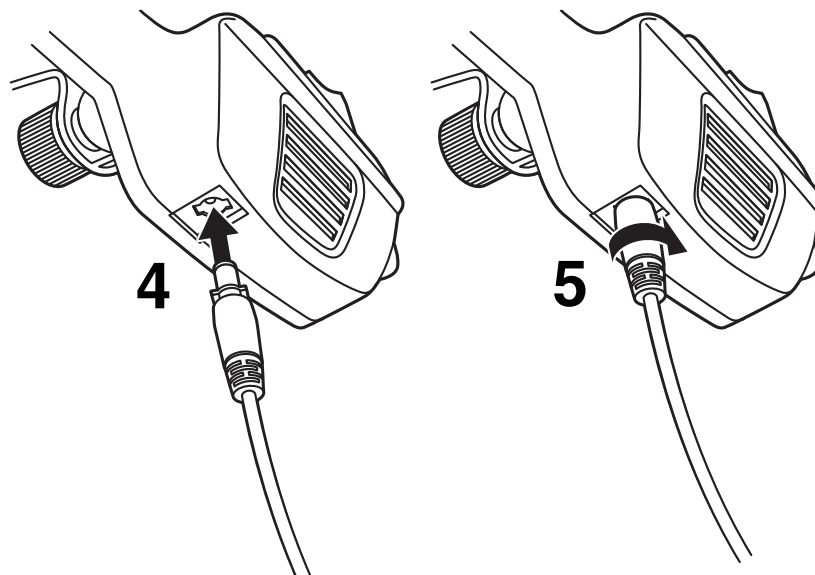

6. Plug the power adapter into the vehicle power outlet (e.g., cigarette lighter outlet)

Charging the Main Battery

The mobile base provides power to the Dolphin and allows charging of the main batteries in the terminal. The main battery charges in 4 hours for the standard battery or 6 hours for the extended battery. The intelligent battery charging system incorporated into all Dolphin terminals prevents overcharging, which means that terminal may be seated in the base indefinitely without damage to the terminal, battery pack, or the base.

For more information about Honeywell battery packs and how to check battery power levels in your terminal, refer to [Battery](#) (page 2-9).

To Power a Terminal and Charge its Main Battery



Ensure all components are dry prior to mating terminals/batteries with peripheral devices. Mating wet components may cause damage not covered by the warranty.



We recommend use of Honeywell Li-Ion battery packs. Use of any non-Honeywell battery may result in damage not covered by the warranty.

1. Install the main battery in the terminal; see [Install the Battery](#) on page 1-1.
2. Mount the Mobile base and install the power cable; see [Mounting the Mobile Base](#) on page 10-3.
3. Pull the spring latch back and insert the Dolphin 75e into the terminal well. Charging begins immediately if required by the Dolphin terminal.

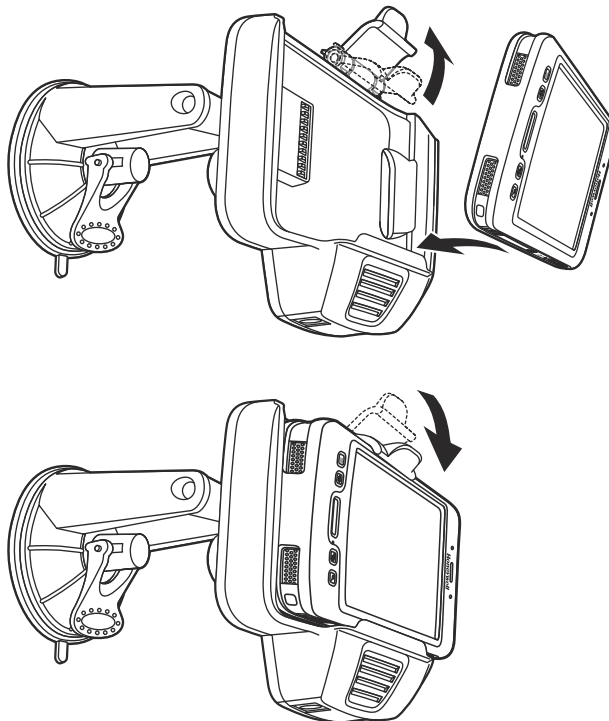

Note: Align the contacts on the back panel of the terminal with the charging contacts on the Mobile Base.

Removing the Cable



Attempting to remove the cable without disengaging the lock may result in damage to the base and power cable not covered by the warranty.

1. Twist the cable 90° counterclockwise to disengage the cable lock.
2. Remove the cable from the power jack.

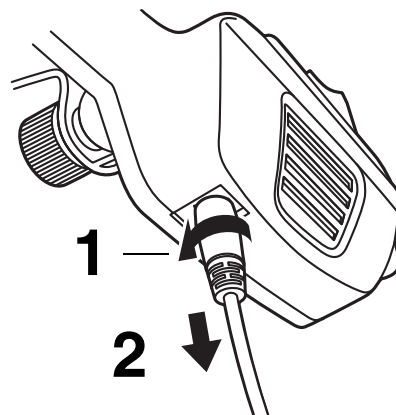

Dolphin 70e Black ChargeBase (Model 70e-CB)

Overview

The Dolphin 70e Black ChargeBase is a 4-slot charging cradle that can power four Dolphin terminals, and charge their main batteries in 4 hours for the standard battery or 6 hours for the extended battery. The 70e-CB charger is designed for use with the following Dolphin models and batteries manufactured for Honeywell International Inc:

| Dolphin Models | Battery Model No. | Battery Part No. | Battery Specification |
|----------------------------|-------------------|------------------|-------------------------------|
| Dolphin 75e Dolphin 70e | 70e-BTSC | BAT-STANDARD-02 | Li-ion 3.7V, 6.179 watt hour |
| | 70e-BTEC | BAT-EXTENDED-02 | Li-ion 3.7V, 12.358 watt hour |



We recommend use of Honeywell peripherals, power cables, and power adapters. Use of any non-Honeywell peripherals, cables, or power adapters may cause damage not covered by the warranty.

Unpacking the ChargeBase

Open the shipping box and inspect the package to see that the following standard items are included:

- One Dolphin ChargeBase, model 70e-CB
- One power supply (see [Power](#) on page 11-3)
- One power cord

These items are needed to operate the ChargeBase. If any items are missing or anything appears to be damaged, contact your Customer Account Representative. Keep the original packaging in case you need to return the ChargeBase for service or to store the ChargeBase while not in use.

Charging Overview

The base supplies power to the intelligent battery charging system in all Dolphin terminals, which senses when a full charge has been achieved and switches to a trickle charge to maintain the full charge. As battery packs charge, the charging circuitry follows the two-step charging process (CC-CV) that is recommended for the battery type. The process monitors changes in temperature, current, and voltage. The main battery of each terminal charges in 4 hours for the standard battery or 6 hours for the extended battery.

Note: Before attempting to use, charge, or replace the battery in the terminal, you should read the [Guidelines for Battery Pack Use and Disposal](#) on page 2-12.



We recommend use of Honeywell Li-ion battery packs. Use of any non-Honeywell battery may result in damage not covered by the warranty.

Convenient Storage

The intelligent battery charging system makes this base a safe and convenient storage receptacle for your Dolphin terminal.

Capacity

The base holds up to four Dolphin terminals. Each charging well charges each terminal independently of the other wells.

Dimensions

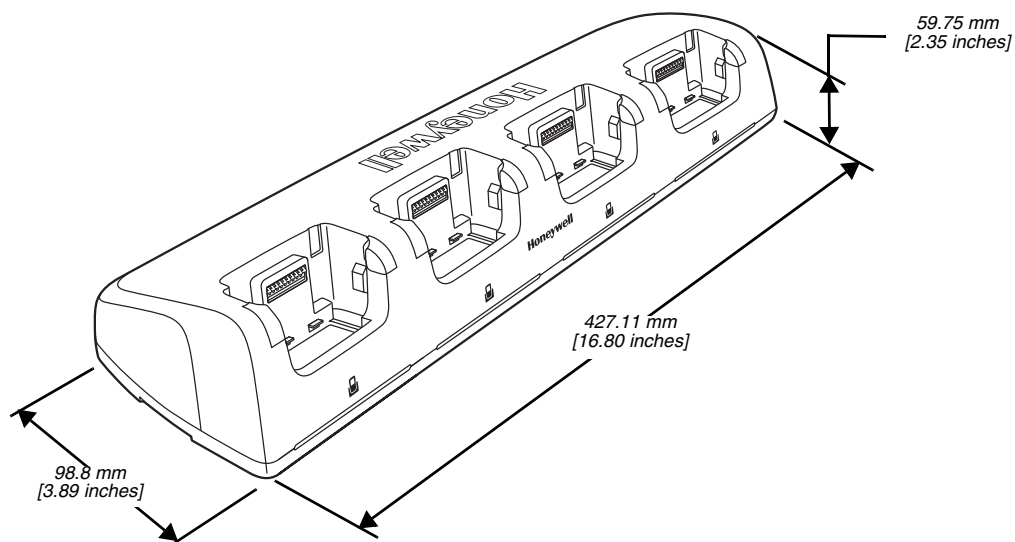

Weight

ChargeBase weight: 674g [1.49 lbs.]

Note: Weight excludes packaging, cables and power supply.

Parts and Functions

Front Panel

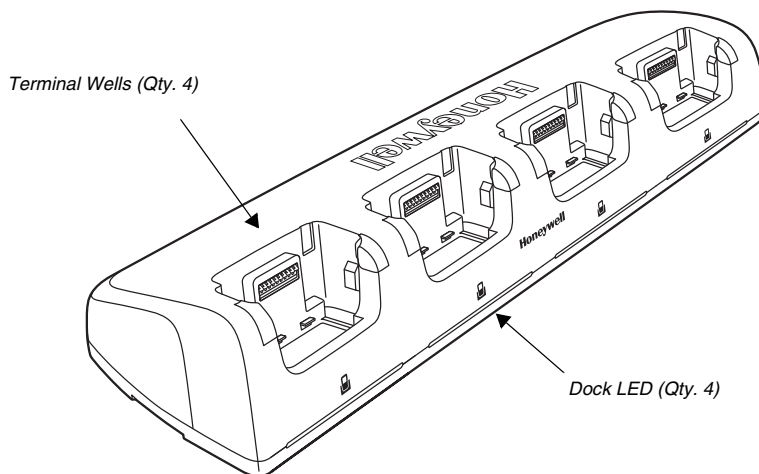

Terminal Wells

The base contains four terminal wells, which offer independent battery charging for each docked terminal.

Dock LEDs

The Dock LED indicates if the terminal is properly seated in the charging well. Each well has a dedicated Dock LED, which illuminates blue when a terminal is properly seated in the charging well.

Back Panel

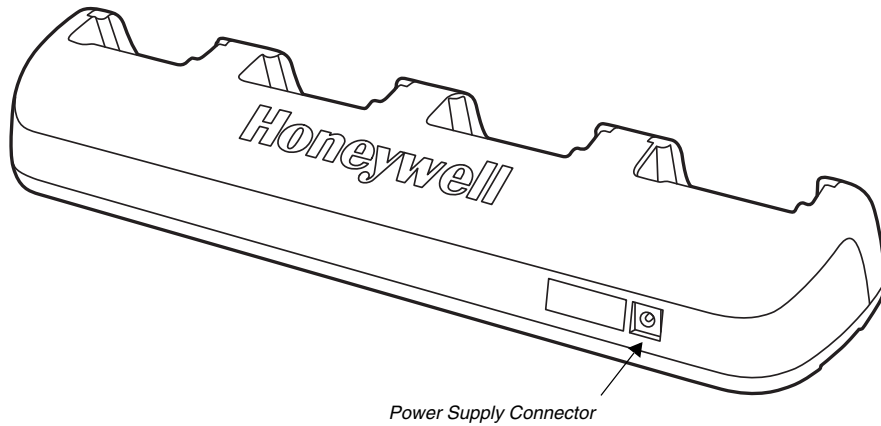

Power Supply Connector

This connector receives input from the power adapter. Plug the power connector cable from the power adapter into this connector.

Bottom Panel

For details on how to mount the base, see [Mounting the ChargeBase](#) on page 11-4.

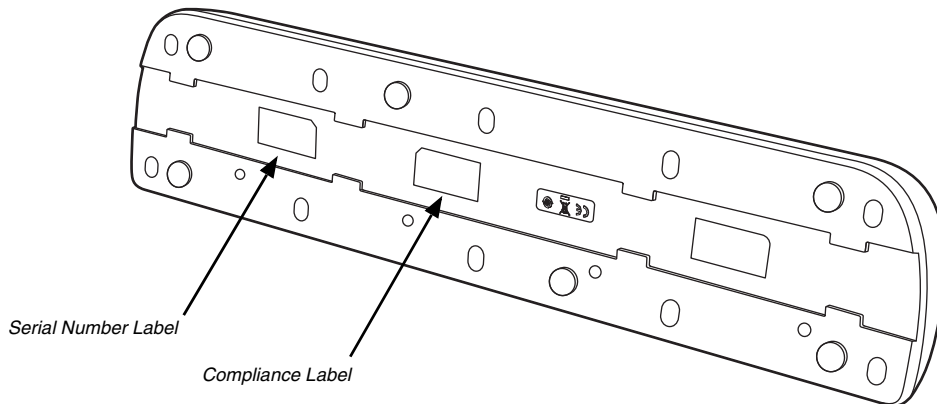

Power

The terminal requires 12 Volts DC input for battery charging and power output to the terminal. The power adapter included with the base, converts the voltage from the AC power source to 12 volts DC. **Use only a UL Listed power supply, which has been qualified by Honeywell with output rated at 12VDC and 5 amps with the device.** The operating temperature range is -10° to 50°C (14° to 122°F).

Honeywell recommends that you leave the ChargeBase connected to its power source at all times, so that it is always ready to use.



We recommend use of Honeywell peripherals, power cables, and power adapters. Use of any non-Honeywell peripherals, cables, or power adapters may cause damage not covered by the warranty.

Connecting Power to the ChargeBase

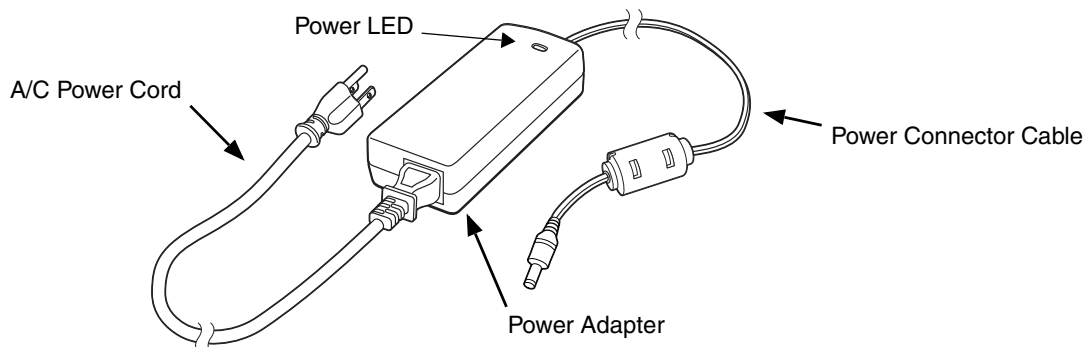

1. Plug the A/C power cord into the power adapter.
2. Plug the power cable into the power connector on the back of the ChargeBase.
3. Plug the A/C power cord into a grounded power source.
4. The base is ready to begin charging terminals.

Charging the Main Battery

The base provides power to the Dolphin terminals and allows charging of the batteries in the terminals. The battery of each terminal charges in 4 hours for the standard battery or 6 hours for the extended battery. The intelligent battery charging system incorporated into all Dolphin terminals prevents overcharging, which means that Dolphin terminals may be seated in the base indefinitely without damage to the terminals, batteries, or the base.



For more information about Honeywell battery packs and how to check battery power level in your terminal, refer to [Battery](#) (page 2-9).

To Power a Terminal and Charge its Main Battery



Ensure all components are dry prior to mating terminals/batteries with peripheral devices. Mating wet components may cause damage not covered by the warranty.

1. Install the battery in the terminal, see [Install the Battery](#) on page 1-1.
2. Insert the Dolphin terminal into one of the four terminal wells. The Dock LED for the well illuminates blue. Charging begins immediately if required by the Dolphin terminal.

Note: When the terminal is docked, the Battery Icon changes from  to  indicating the terminal is running on external power. Battery charging occurs in the background. When the Dolphin is removed from the base, the battery icon indicates the charge level of the battery, see [Common Status and Notification Icons](#) on page 1-7.



We recommend use of Honeywell Li-ion battery packs. Use of any non-Honeywell battery may result in damage not covered by the warranty.

Mounting the ChargeBase

Set the base on a dry, stable surface, such as a desktop or workbench near an electrical outlet. Be sure to provide enough workspace with good lighting for the user to view and operate the Dolphin terminal while it is in the base. When choosing a location, keep in mind that the mounting location must allow users to see the LEDs and provide easy access to the terminal wells and the power jack.

Bottom Panel

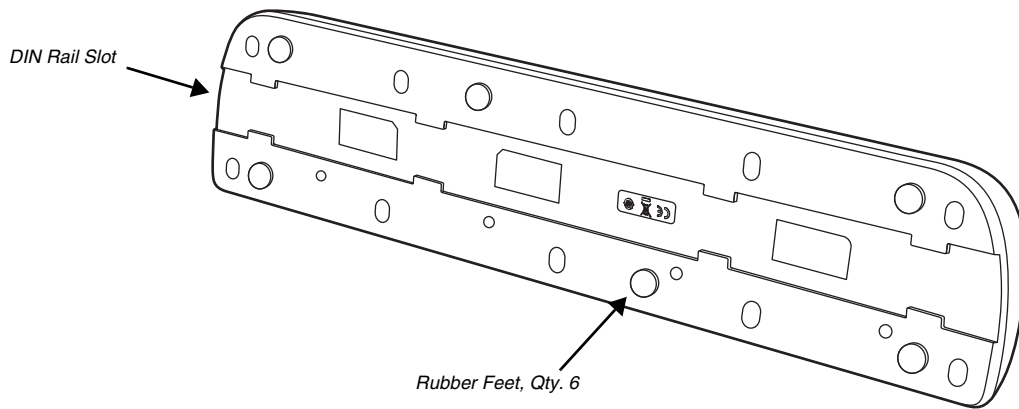

Optional DIN Rail Mount

A DIN rail (7.5 X 35 mm) may be installed on the bottom of the base to provide the optional security of mounting the base to a flat horizontal surface with hardware.

Additional Hardware

- DIN Rail, Qty. 1
- 3/16 in. dia x 5/8 in. long pan head screw, Qty. 2
- 1/2 in. OD x 7/32 in. ID x 3/64 in. thick washer, Qty. 4
- 3/16 in. dia nut, Qty. 2

Note: The items listed above are for reference only. Final hardware selection is dependent on the material type and thickness of the mounting surface.

Installing the DIN Rail

1. Slide the DIN Rail into the DIN Rail slot on the bottom panel of the base.

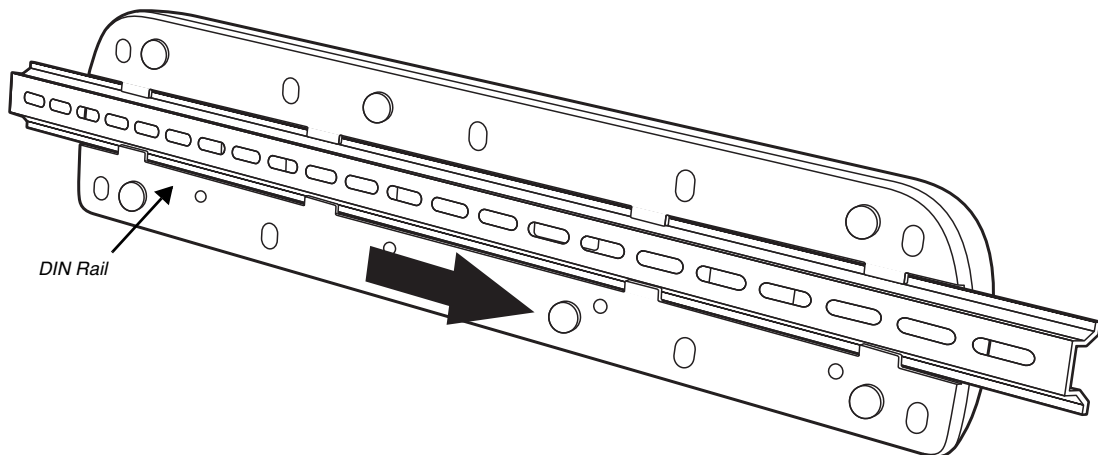

2. Turn the base and DIN Rail right side up.
3. Use the appropriate hardware to secure the DIN Rail to a stable, flat horizontal surface.



Dolphin 70e Black Net Base (Model 70e-NB)

Overview

The Net Base enables up to four Dolphin 75e handheld computers to communicate with a host device over an Ethernet network. In addition, the Net Base provides a second RJ45 Ethernet port for connection to an additional device such as a printer, workstation, Net Base, or another Net Base. The 70e-NB charger is designed for use with the following Dolphin models and batteries manufactured for Honeywell International Inc:

| Dolphin Model | Battery Model No. | Battery Part No. | Battery Specification |
|----------------------------|-------------------|------------------|-------------------------------|
| Dolphin 75e Dolphin 70e | 70e-BTSC | BAT-STANDARD-02 | Li-ion 3.7V, 6.179 watt hour |
| | 70e-BTEC | BAT-EXTENDED-02 | Li-ion 3.7V, 12.358 watt hour |



We recommend use of Honeywell peripherals, power cables, and power adapters. Use of any non-Honeywell peripherals, cables, or power adapters may cause damage not covered by the warranty.

Unpacking the Net Base

Open the shipping box and inspect the package to see that the following standard items are included:

- One Dolphin Net Base Ethernet cradle, model 70e-NB
- One power supply (see [Power](#) on page 12-4)
- One power cord

These items are needed to set up and operate the Net Base. If any items are missing or anything appears to be damaged, contact your Customer Account Representative. Keep the original packaging in case you need to return the Net Base for service or to store the Net Base while not in use.

Optional Equipment

A standard CAT-5 Ethernet network cable is required when using the Net Base for communication between the terminal(s) and a host device over an Ethernet network.

Charging Overview

The base supplies power to the intelligent battery charging system in all Dolphin terminals, which senses when a full charge has been achieved and switches to a trickle charge to maintain the full charge. As battery packs charge, the charging circuitry follows the two-step charging process (CC-CV) that is recommended for the battery type. The process monitors changes in temperature, current, and voltage. The main battery of each terminal charges in 4 hours for the standard battery or 6 hours for the extended battery.

Note: Before attempting to use, charge, or replace the battery in the terminal, you should read the [Guidelines for Battery Pack Use and Disposal](#) on page 2-12.



We recommend use of Honeywell Li-ion battery packs. Use of any non-Honeywell battery may result in damage not covered by the warranty.

Convenient Storage

The intelligent battery charging system makes this base a safe and convenient storage receptacle for your Dolphin terminal.

Capacity

The base holds up to four Dolphin terminals. Each charging well charges each terminal independently of the other wells.

Dimensions

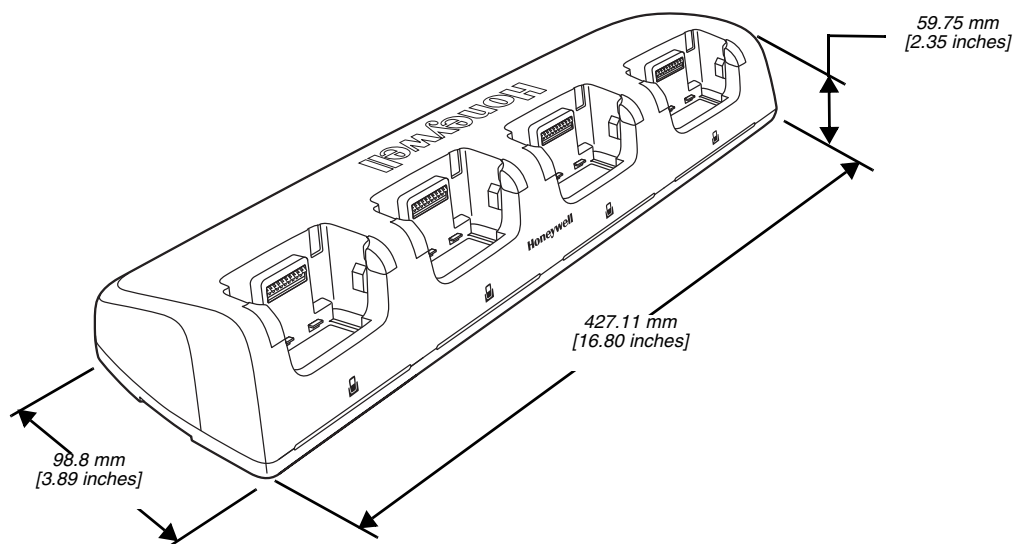

Weight

Net Base weight: 694g [1.53 lbs.]

Note: Weight excludes packaging, cables and power supply.

Parts and Functions

Front Panel

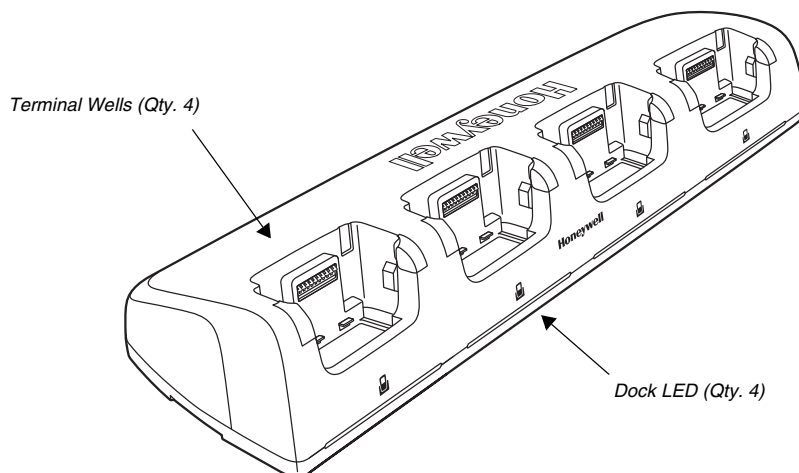

Terminal Wells

The base contains four terminal wells, which offer independent battery charging for each docked terminal.

DOCK LEDs

The Dock LED indicates if the terminal is properly seated in the charging well. Each well has a dedicated Dock LED, which illuminates blue when a terminal is properly seated in the charging well.

Back Panel

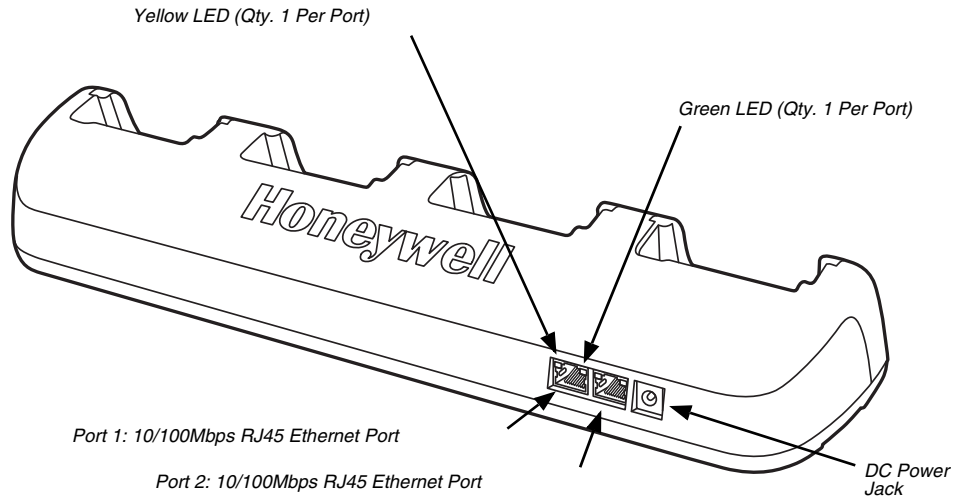

RJ45 Ethernet Ports

The Net Base contains two RJ45 Ethernet ports. You can connect the Net Base to an Ethernet-compliant device to facilitate Ethernet communication to and from the terminal by plugging a standard CAT-5 Ethernet cable into one of the two Ethernet ports provided. The second RJ45 Ethernet port can be used for connection to an additional device such as a printer, workstation, eBase, or another Net Base.

Note: The Net Base does not use a Spanning Tree Protocol (STP). When both RJ45 Ethernet ports are used, do not connect both Net Base interfaces to the same layer 2 LAN.

Each RJ45 Ethernet port has a dedicated green and yellow status LED.

| Status | Yellow LED | Green LED |
|---|---|-----------|
| No Ethernet Link | Off | Off |
| 10Mbps Ethernet Connection Established | Off | On |
| 100Mbps Ethernet Connection Established | On | On |
| Data transfer in progress | Connection Speed Dependent (see above) | Flashing |

Note: The terminal and Ethernet link must be set up properly to allow the terminal to communicate to other devices and/or the Internet. For more information, see [Establishing Ethernet Communication](#) on page 12-5.

DC Power Jack

This connector receives input from the power adapter. Plug the power connector cable from the power adapter into this connector, see [Power](#).

Bottom Panel

For details on how to mount the base, see [Mounting the Net Base](#) on page 12-6.

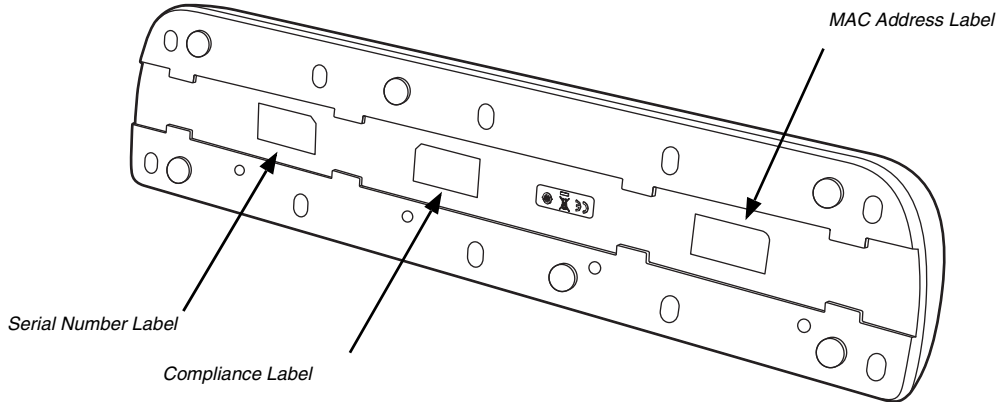

Power

The terminal requires 12 Volts DC input for battery charging and power output to the terminal. The power adapter included with the base, converts the voltage from the AC power source to 12 volts DC. **Use only a UL Listed power supply, which has been qualified by Honeywell with output rated at 12VDC and 5 amps with the device.** The operating temperature range is -10° to 50°C (14° to 122°F).

Honeywell recommends that you leave the Net Base connected to its power source at all times, so that it is always ready to use.



We recommend use of Honeywell peripherals, power cables, and power adapters. Use of any non-Honeywell peripherals, cables, or power adapters may cause damage not covered by the warranty.

Connecting Power to the Net Base

1. Plug the A/C power cord into the power adapter.
2. Plug the power cable into the power connector on the back of the Net Base.
3. Plug the A/C power cord into a grounded power source.
4. The base is ready to begin charging terminals.

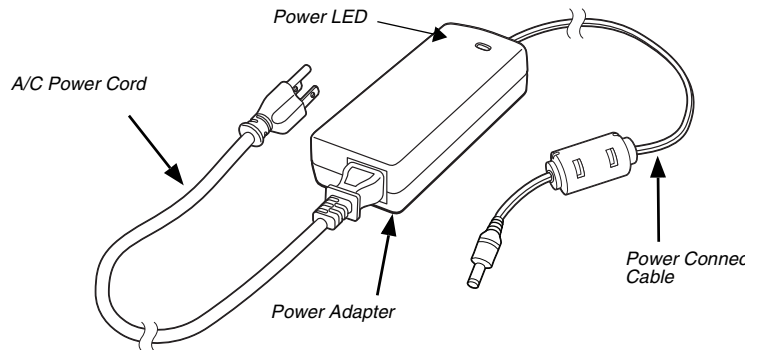

Charging the Main Battery

The base provides power to the Dolphin terminals and allows charging of the batteries in the terminals. The battery of each terminal charges in 4 hours for the standard battery or 6 hours for the extended battery. The intelligent battery charging system incorporated into all Dolphin terminals prevents overcharging, which means that Dolphin terminals may be stored in the base indefinitely without damage to the terminals, battery packs, or the base.



For more information about Honeywell battery packs and how to check battery power levels in your terminal, refer to [Battery](#) (page 2-9).

To Power a Terminal and Charge the Main Battery



Ensure all components are dry prior to mating terminals/batteries with peripheral devices. Mating wet components may cause damage not covered by the warranty.

-
1. Install the battery in the terminal, see page 1-1.
 2. Slide the Dolphin terminal into one of the four terminal wells. The Dock LED for the well illuminates blue. Charging begins immediately if required by the Dolphin terminal.

Note: When the terminal is docked, the Battery Icon changes from  to  indicating the terminal is running on external power. Battery charging occurs in the background. When the Dolphin is removed from the base, the battery icon indicates the charge level of the battery, see [Common Status and Notification Icons](#) on page 1-7.







We recommend use of Honeywell Li-ion battery packs. Use of any non-Honeywell battery may result in damage not covered by the warranty.

Communication

Establishing Ethernet Communication

Connecting the Dolphin Terminal to the Net Base

By default, the Dolphin terminal is configured to obtain IP addresses automatically via DHCP server. This means that in most cases you would simply plug-and-play the unit.



1. Connect power to the Net Base (see [Power](#) on page 12-4).
2. Plug the CAT-5 Ethernet cable into the RJ45 connector on the back of the Net Base.
3. Plug the Ethernet cable into the network.
4. Insert the Dolphin into the terminal well. The Dock LED for the well illuminates blue.
5. Touch **All Apps**  > **Settings**  > **Ethernet configuration**.
6. Check the box to **Turn on Ethernet**. When an Ethernet connection is established the status icon changes from  to  at the top of the screen.

Troubleshooting

If the items on the Ethernet configuration screen are grayed out and not accessible, verify the base has power, the Ethernet cable is undamaged and properly installed to the base, there is an active network signal over the Ethernet cable, and the terminal is properly docked in the base.



Ethernet Configuration Settings

Instead of using the default DHCP assigned IP address, the Dolphin terminal can be configured to use a statically assigned IP address.

1. Touch **All Apps**  > **Settings**  > **Ethernet configuration**.
2. Select **Ethernet configuration**, again.
3. Select **Static IP** under “Connection Type”, then input the **IP address** and any additional information based on your network configuration.
4. Touch **Save**.

Ethernet Proxy Settings

To set up a proxy to use when accessing your network with Ethernet:

-
1. Touch **All Apps**  > **Settings**  > **Ethernet proxy settings**.
 2. Input the **Proxy host name** and **Proxy port**. If required, designate when to bypass the proxy.
 3. Select **Done**.

Displaying the Net Base and Terminal IP Address

Once the Dolphin terminal has been successfully connected to the network through Net Base, the terminal uses the Net Base IP address. The IP address can be used by any application on the Dolphin terminal.

Touch **All Apps**  > **Settings**  > **About Phone** > **Status** to view the assigned IP Address.

Mounting the Net Base

Set the Net Base on a dry, stable surface, such as a desktop or workbench near an electrical outlet. Be sure to provide enough workspace with good lighting for the user to view and operate the Dolphin terminal while it is in the Net Base. When choosing a location, bear in mind that the mounting location must allow users to see the LEDs and provide easy access to the terminal wells, the Ethernet ports, and the power jack.

Bottom Panel

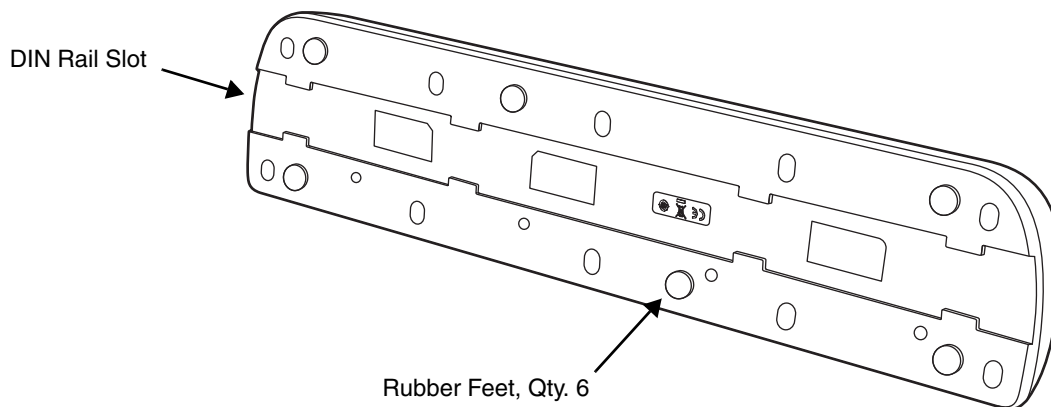

Optional DIN Rail Mount

A DIN rail (7.5 X 35 mm) may be installed on the bottom of the base to provide the optional security of mounting the base to a flat horizontal surface with hardware.

Additional Hardware

- DIN Rail, Qty. 1
- 3/16 in. dia x 5/8 in. long pan head screw, Qty. 2
- 1/2 in. OD x 7/32 in. ID x 3/64 in. thick washer, Qty. 4
- 3/16 in. dia nut, Qty. 2

Note: The items listed above are for reference only. Final hardware selection is dependent on the material type and thickness of the mounting surface.

Installing the DIN Rail

1. Slide the DIN Rail into the DIN Rail slot on the bottom panel of the base.

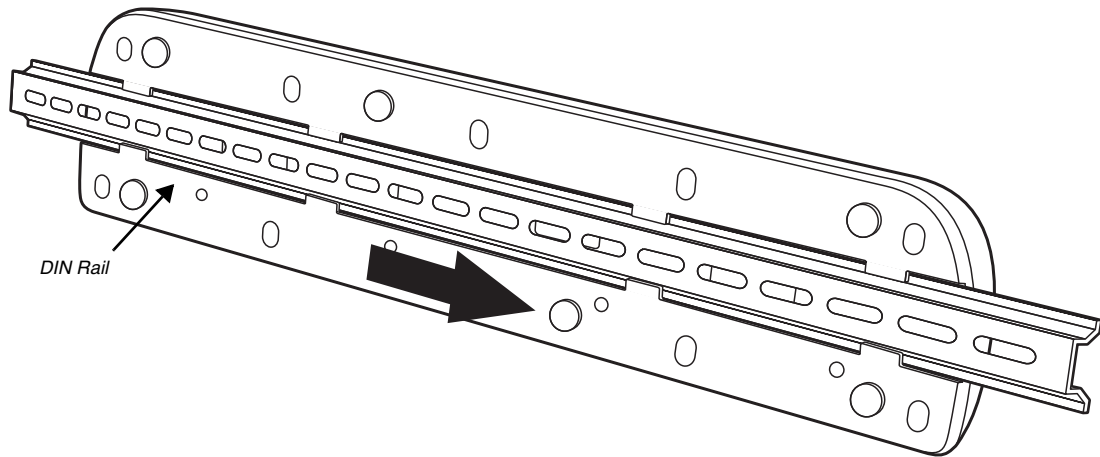

2. Turn the base and DIN Rail right side up.
3. Use the appropriate hardware to secure the DIN Rail to a stable, flat horizontal surface.



Dolphin 75e Terminal Agency Information

Dolphin 75e handheld computers meet or exceed the requirements of all applicable organizations that set standards for safe operation. The best way to ensure safe operation is to use the handheld computer according to the agency guidelines in this user guide and on the regulatory sheet shipped with the terminal. Read all guidelines before using your Dolphin terminal. To download product documentation for the Dolphin 75e handheld computer, go to www.honeywellaidc.com.

This documentation is relevant for the following Dolphin model: 75eL0N.



Caution: Read the [Guidelines for Battery Pack Use and Disposal](#) on page 3-16 and all cautionary markings on the battery, charging peripheral, or device using the battery before attempting to install, use, or charge the battery. Risk of fire and burns if improperly handled. Do not open, crush, heat above 60°C (140°F), or incinerate.

Label Locations

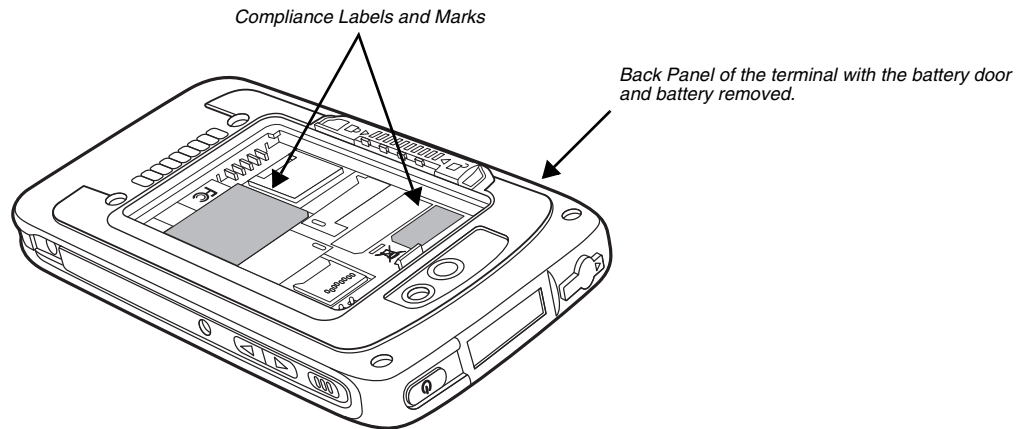

Model Number and Serial Number

The model (item) number and serial number for the terminal are located on labels affixed to the bottom of the battery well.

RF Exposure Information (SAR)

This handheld computer meets the government's requirements for exposure to radio waves. This handheld computer is designed and manufactured not to exceed the emission limits for exposure to radio frequency (RF) energy set by the Federal Communications Commission of the U.S. Government.

The exposure standard for wireless devices employs a unit of measurement known as the Specific Absorption Rate, or SAR. The SAR limit set by the FCC is 1.6 W/Kg and for Europe 2 W/Kg. Although the SAR is determined at the highest certified power level, the actual SAR level of the handheld computer while operating can be well below the maximum value. This is because the device is designed to operate at multiple power levels so as to use only the power required to reach the network. In general, the closer you are to a wireless base station antenna, the lower the power output.

The highest reported SAR values for head and body-worn accessory are: 0.367 W/kg (1 g) for body and 0.596 W/kg (1 g) for head.

The highest reported CE SAR values for head and body-worn accessory are: 0.170 W/kg (10 g) for body and 0.310 W/kg (10 g) for head.

While there may be differences between the SAR levels of various handheld computer and at various positions, they all meet the government requirement.

The FCC has granted an Equipment Authorization for this handheld computer with all reported SAR levels evaluated as in compliance with the FCC RF exposure guidelines. SAR information on this handheld computer is on file with the FCC and can be found under the Display Grant section of www.fcc.gov/oet/ea/fccid after searching on FCC ID: HD5-75EL0N.



Honeywell Scanning & Mobility

9680 Old Bailes Road

Fort Mill, SC 29707

www.honeywellaidc.com