

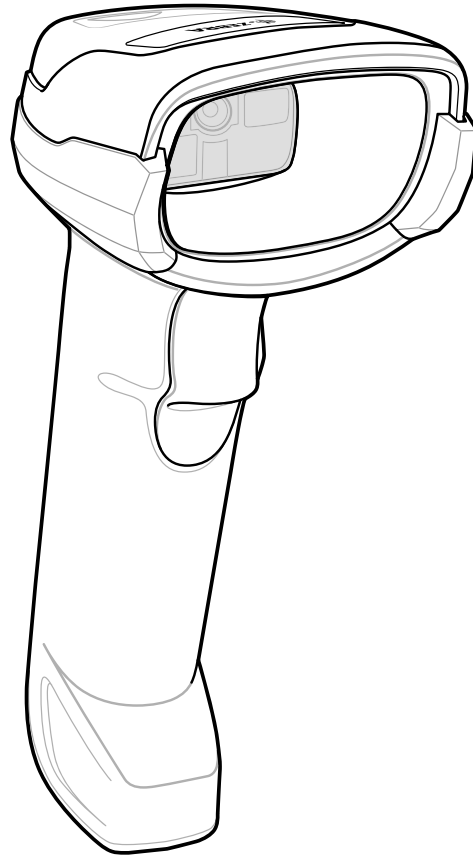

# DS2278



## Digital Scanner

---

## Product Reference Guide



# **DS2278 DIGITAL SCANNER PRODUCT REFERENCE GUIDE**

MN-002915-14EN

Revision A

November 2024

No part of this publication may be reproduced or used in any form, or by any electrical or mechanical means, without permission in writing from Zebra. This includes electronic or mechanical means, such as photocopying, recording, or information storage and retrieval systems. The material in this manual is subject to change without notice.

The software is provided strictly on an “as is” basis. All software, including firmware, furnished to the user is on a licensed basis. Zebra grants to the user a non-transferable and non-exclusive license to use each software or firmware program delivered hereunder (licensed program). Except as noted below, such license may not be assigned, sub-licensed, or otherwise transferred by the user without prior written consent of Zebra. No right to copy a licensed program in whole or in part is granted, except as permitted under copyright law. The user shall not modify, merge, or incorporate any form or portion of a licensed program with other program material, create a derivative work from a licensed program, or use a licensed program in a network without written permission from Zebra. The user agrees to maintain Zebra’s copyright notice on the licensed programs delivered hereunder, and to include the same on any authorized copies it makes, in whole or in part. The user agrees not to decompile, disassemble, decode, or reverse engineer any licensed program delivered to the user or any portion thereof.

Zebra reserves the right to make changes to any software or product to improve reliability, function, or design.

Zebra does not assume any product liability arising out of, or in connection with, the application or use of any product, circuit, or application described herein.

No license is granted, either expressly or by implication, estoppel, or otherwise under any Zebra Technologies Corporation, intellectual property rights. An implied license only exists for equipment, circuits, and subsystems contained in Zebra products.

---

## Warranty

For the complete Zebra hardware product warranty statement, go to: [www.zebra.com/warranty](http://www.zebra.com/warranty).

---

## Patents

[ip.zebra.com](http://ip.zebra.com)

## Revision History

Changes to the original guide are listed below:

Change	Date	Description
MN-002915-01 Rev. A	7/2017	Initial Release.
MN-002915-02 Rev. A	8/2017	Removed "Microsoft UWP Bluetooth" information.
MN-002915-03 Rev. A	04/2018	<p>Rev. B software and miscellaneous updates.</p> <p>Added:</p> <ul style="list-style-type: none"> <li>- Battery Preservation Timeout Value.</li> <li>- Re-pair on Double Trigger Press.</li> <li>- Note to Out of Range Batch Mode about Auto-Reconnect.</li> <li>- Added note below Bluetooth Security.</li> </ul> <p>Updated:</p> <ul style="list-style-type: none"> <li>- Pairing bar code format with STC info.</li> <li>- Values under bar codes for SSI baud rates: 230,400, 460,800, 921,600.</li> <li>- Pairing Using the Scan-To-Connect (STC) Utility.</li> <li>- Max time value in Hands-Free Decode Session Timeout.</li> <li>- Deleted Bluetooth HID - Wait for Connection (not supported).</li> <li>- Added note to MSI Reduced Quiet Zone (Level 3 not supported by MSI).</li> <li>- Changed Microsoft UWP USB to USB HID POS.</li> <li>- Second paragraph under "Connection Maintenance Interval".</li> <li>- 123Scan chapter</li> <li>- Picklist Mode description.</li> <li>- Trigger Mode, Presentation (Blink) description.</li> </ul>
MN-002915-04 Rev. A	7/2018	<p>Added:</p> <ul style="list-style-type: none"> <li>- LED on Good Decode.</li> <li>- Pairing Bar Code Format for Serial Port Connections.</li> <li>- USB certification.</li> <li>- Setting Up a Windows Product To Work With The Digital Scanner.</li> <li>- New Appendix N - Upgrading Over Bluetooth Without a Cradle.</li> </ul> <p>Updated:</p> <ul style="list-style-type: none"> <li>- One instance of Class 1 to Class 2.</li> <li>- Firmware download option (not supported with Micro USB cable).</li> <li>- Configurations.</li> <li>- "Connecting the Cradle" and "Changing the Host Interface".</li> </ul>
MN-002915-05 Rev. A	10/2018	<ul style="list-style-type: none"> <li>- Added Grid Matrix sample bar code.</li> <li>- Moved 123Scan chapter.</li> </ul>
MN-002915-06 Rev. A	01/2020	<ul style="list-style-type: none"> <li>- Added ARINC param.</li> <li>- Updated URLs.</li> <li>- Updated Zebra copyright statement.</li> </ul>
MN-002915-07EN Rev. A	04/2020	<ul style="list-style-type: none"> <li>- Split 123Scan chapter to Chapter 2 123Scan and Software Tools and Chapter 14 Data Formatting: ADF.</li> <li>- Updated Chapter 2 123Scan Requirements.</li> <li>- Updated Chapter 3 introduction section.</li> <li>- Updated Environmental Sealing in Table 4-2.</li> <li>- Added the USB Cert information in Table 4-2.</li> </ul>
MN-002915-08EN Rev. A	12/2020	Replaced offending terms.

Change	Date	Description
MN-002915-09EN Rev. A	02/2021	Updated LED on Good Decode.
MN-002915-10EN Rev. A	04/2021	Removed Bluetooth Classic Bluetooth and/or Low Energy (Cradle Parameter Only/ Cradle Host Only).
MN-002915-11EN Rev. A	07/2021	Added Standard Bluetooth Version 4.0 with BLE.
MN-002915-12EN Rev. A	09/2021	Added DotCode, DotCode Inverse, DotCode Mirrored, DotCode Prioritize, DotCode Erasure Limit, Codabar Mod 16 Check Digit, Transmit Codabar Check Digit, Transmit Ean-8 Check Digit, Transmit Ean-13 Check Digit, Weblink QR, and Linked QR Mode.
MN-002915-13EN Rev. A	01/2023	Add Virtual Tether parameters. Update Bluetooth State Note.
MN-002915-14EN Rev. A	11/2024	Removed parameters; Pin Code, Variable Pin Code, and Legacy Bluetooth Security in Bluetooth Security Levels. Updated description for Bluetooth Security Levels parameter.

# TABLE OF CONTENTS

Warranty .....	ii
Patents .....	ii
Revision History .....	iii

## About This Guide

Introduction .....	xix
Configurations .....	xix
Related Product Line Configurations .....	xx
Cables .....	xx
Chapter Descriptions .....	xx
Notational Conventions .....	xxi
Related Documents .....	xxii
Service Information .....	xxii
Provide Documentation Feedback .....	xxii

## Chapter 1: Getting Started

Introduction .....	1-1
Interfaces .....	1-2
Unpacking .....	1-2
DS2278 Features .....	1-3
Cradle Features .....	1-3
Presentation Cradle .....	1-4
Connecting the Cradle .....	1-4
Changing the Host Interface .....	1-4
Using a DC Power Supply .....	1-5
Charging the DS2278 Battery .....	1-5
Charging Using the Cradle .....	1-5
Charging Using the Micro USB Cable .....	1-6
Shutting Off the Digital Scanner Battery .....	1-7
Inserting the Battery .....	1-7
Removing the Battery .....	1-8
Inserting the Digital Scanner in the Cradle .....	1-9
Sending Data to the Host Computer .....	1-9

Pairing .....	1-9
Lost Connection to Host .....	1-10
Configuring the Digital Scanner .....	1-10
Radio Communications .....	1-10
Accessories .....	1-10
<b>Chapter 2: 123Scan and Software Tools</b>	
Introduction .....	2-1
123Scan .....	2-1
Communication with 123Scan .....	2-2
123Scan Requirements .....	2-2
123Scan Information .....	2-2
Scanner SDK, Other Software Tools, and Videos .....	2-3
Scanner Control App .....	2-4
Scan-To-Connect (STC) Utility .....	2-4
<b>Chapter 3: Data Capture</b>	
Introduction .....	3-1
Beeper and LED Indications .....	3-1
Digital Scanner Indications .....	3-1
Cradle LED Indications .....	3-5
Scanning .....	3-6
Hand-Held Scanning .....	3-6
Hands-Free Scanning .....	3-7
Aiming with Digital Scanner .....	3-8
Aiming .....	3-8
Decode Ranges .....	3-8
<b>Chapter 4: Maintenance, Troubleshooting, &amp; Technical Specifications</b>	
Introduction .....	4-1
Maintenance .....	4-1
Known Harmful Ingredients .....	4-1
Approved Cleaners for the Digital Scanner and Cradle .....	4-2
Cleaning the Digital Scanner .....	4-2
Troubleshooting .....	4-3
Report Software Version Bar Code .....	4-7
Technical Specifications .....	4-8
Cradle Signal Descriptions .....	4-11
<b>Chapter 5: User Preferences &amp; Miscellaneous Options</b>	
Introduction .....	5-1
Setting Parameters .....	5-1
Scanning Sequence Examples .....	5-2
Errors While Scanning .....	5-2
User Preferences/Miscellaneous Options Parameter Defaults .....	5-2
User Preferences .....	5-5
Default Parameters .....	5-5
Parameter Bar Code Scanning .....	5-6

- Beep After Good Decode ..... 5-6
- Beeper Volume ..... 5-7
- Beeper Tone ..... 5-8
- Beeper Duration ..... 5-9
- Suppress Power Up Beeps ..... 5-9
- LED on Good Decode ..... 5-10
- Direct Decode Indicator ..... 5-10
- Low Power Mode ..... 5-11
- Time Delay to Low Power Mode ..... 5-12
- Timeout to Low Power Mode from Auto Aim ..... 5-14
- Battery Preservation Mode ..... 5-15
- Trigger Mode ..... 5-16
- Hands-Free Mode ..... 5-17
- Hand-Held Decode Aiming Pattern ..... 5-18
- Hands-Free (Presentation) Decode Aiming Pattern ..... 5-19
- Picklist Mode ..... 5-20
- Continuous Bar Code Read ..... 5-21
- Unique Bar Code Reporting ..... 5-21
- Decode Session Timeout ..... 5-22
- Hands-Free Decode Session Timeout ..... 5-22
- Timeout Between Decodes, Same Symbol ..... 5-23
- Timeout Between Decodes, Different Symbols ..... 5-23
- Decode Mirror Images (Data Matrix Only) ..... 5-24
- Mobile Phone/Display Mode ..... 5-24
- PDF Prioritization ..... 5-25
- PDF Prioritization Timeout ..... 5-25
- Decoding Illumination ..... 5-26
- Illumination Brightness ..... 5-26
- Low Light Scene Detection ..... 5-27
- Motion Tolerance (Hand-Held Trigger Modes Only) ..... 5-28
- Product ID (PID) Type ..... 5-29
- Product ID (PID) Value ..... 5-29
- ECLevel ..... 5-30
- Miscellaneous Scanner Parameters ..... 5-31
  - Enter Key ..... 5-31
  - Tab Key ..... 5-31
  - Transmit Code ID Character ..... 5-32
  - Prefix/Suffix Values ..... 5-33
  - Scan Data Transmission Format ..... 5-34
  - FN1 Substitution Values ..... 5-36
  - Transmit “No Read” Message ..... 5-37
  - Unsolicited Heartbeat Interval ..... 5-38
- Send Versions ..... 5-39
  - Software Version ..... 5-39
  - Serial Number ..... 5-39
  - Manufacturing Information ..... 5-39

**Chapter 6: Radio Communications**

- Introduction ..... 6-1
- Setting Parameters ..... 6-1



Scanning Sequence Examples .....	6-2
Errors While Scanning .....	6-2
Radio Communications Parameter Defaults .....	6-2
Wireless Beeper Definitions .....	6-5
Radio Communication Host Types .....	6-5
Bluetooth Classic vs. Low Energy Bluetooth .....	6-5
Cradle .....	6-5
Human Interface Device (HID) Keyboard Emulation .....	6-6
Simple Serial Interface (SSI) .....	6-7
Serial Port Profile (SPP) .....	6-9
Bluetooth Technology Profile Support .....	6-9
Central/Peripheral Set Up .....	6-10
Bluetooth Friendly Name .....	6-10
Discoverable Mode .....	6-11
Wi-Fi Friendly Mode .....	6-12
Notes .....	6-12
Wi-Fi Friendly Channel Exclusion .....	6-12
Radio Output Power .....	6-14
Link Supervision Timeout .....	6-15
Bluetooth Radio State .....	6-16
HID Host Parameters .....	6-16
Apple iOS Virtual Keyboard Toggle .....	6-16
HID Keyboard Keystroke Delay .....	6-18
HID CAPS Lock Override .....	6-18
HID Ignore Unknown Characters .....	6-19
Emulate Keypad .....	6-19
Fast HID Keyboard .....	6-20
Quick Keypad Emulation .....	6-20
HID Keyboard FN1 Substitution .....	6-21
HID Function Key Mapping .....	6-21
Simulated Caps Lock .....	6-22
Convert Case .....	6-22
Auto-Reconnect Feature .....	6-23
Reconnect Attempt Beep Feedback .....	6-23
Reconnect Attempt Interval .....	6-24
Auto-Reconnect .....	6-25
Out of Range Indicator .....	6-25
Beep on Insertion .....	6-26
Beep on <BEL> .....	6-26
Digital Scanner To Cradle Support .....	6-27
Pairing .....	6-27
Pairing Methods .....	6-28
Connection Maintenance Interval .....	6-29
Pairing Using the Scan-To-Connect (STC) Utility .....	6-31
Pairing Bar Code Format for Serial Port Connections .....	6-31
Pairing Bar Code Example .....	6-31
Batch Mode .....	6-32
Modes of Operation .....	6-32
Persistent Batch Storage .....	6-34
Bluetooth Security .....	6-35

Bluetooth Security Levels .....	6-35
Bluetooth Radio, Linking, and Batch Operation .....	6-37
Setting Up an iOS or Android Product To Work With The Digital Scanner .....	6-37
Setting Up a Windows Product To Work With The Digital Scanner .....	6-38
Save Bluetooth Connection Information .....	6-39
Virtual Tether .....	6-40
Virtual Tether Alarm on the Scanner .....	6-40
Virtual Tether Alarm on the Cradle .....	6-43
Delay Before Virtual Alarm Activates .....	6-43
Virtual Tether Alarm Duration .....	6-44
Defeat Virtual Tether Alarm .....	6-45
Pause Virtual Tether Alarm Duration .....	6-45

## Chapter 7: Signature Capture Preferences

Introduction .....	7-1
Setting Parameters .....	7-1
Scanning Sequence Examples .....	7-2
Errors While Scanning .....	7-2
Signature Capture Preferences Parameter Defaults .....	7-2
Signature Capture Preferences .....	7-3
Signature Capture .....	7-3
Signature Capture File Format Selector .....	7-4
Signature Capture Bits Per Pixel .....	7-5
Signature Capture Width .....	7-6
Signature Capture Height .....	7-6
Signature Capture JPEG Quality .....	7-6

## Chapter 8: USB Interface

Introduction .....	8-1
Setting Parameters .....	8-1
Scanning Sequence Examples .....	8-1
Errors While Scanning .....	8-1
Connecting a USB Interface .....	8-2
USB Parameter Defaults .....	8-3
USB Host Parameters .....	8-5
USB Device Type .....	8-5
Symbol Native API (SNAPI) Status Handshaking .....	8-7
Native Firmware Update .....	8-7
USB Keystroke Delay .....	8-8
USB CAPS Lock Override .....	8-8
Bar Codes with Unknown Characters .....	8-9
USB Convert Unknown to Code 39 .....	8-9
USB Fast HID .....	8-10
USB Polling Interval .....	8-11
Keypad Emulation .....	8-13
Quick Keypad Emulation .....	8-13
Keypad Emulation with Leading Zero .....	8-14
USB Keyboard FN1 Substitution .....	8-14
Function Key Mapping .....	8-15

Simulated Caps Lock .....	8-15
Convert Case .....	8-16
USB Static CDC .....	8-16
CDC Beep on <BEL> .....	8-17
USB CDC Host Variant .....	8-17
TGCS (IBM) USB Direct I/O Beep .....	8-19
TGCS (IBM) USB Beep Directive .....	8-20
TGCS (IBM) USB Bar Code Configuration Directive .....	8-20
TGCS (IBM) USB Specification Version .....	8-21
ASCII Character Sets for USB .....	8-21

## Chapter 9: SSI Interface

Introduction .....	9-1
Communication .....	9-1
SSI Transactions .....	9-3
General Data Transactions .....	9-3
Decoded Data Transmission .....	9-4
Communication Summary .....	9-6
RTS/CTS Lines .....	9-6
ACK/NAK Option .....	9-6
Number of Data Bits .....	9-6
Serial Response Timeout .....	9-6
Retries .....	9-6
Baud Rate, Stop Bits, Parity, Response Timeout, ACK/NAK Handshaking .....	9-6
Errors .....	9-6
SSI Communication Notes .....	9-7
Using Time Delay to Low Power Mode with SSI .....	9-7
Encapsulation of RSM Commands/Responses over SSI .....	9-8
Command Structure .....	9-8
Response Structure .....	9-8
Example Transaction .....	9-9
Setting Parameters .....	9-10
Scanning Sequence Examples .....	9-10
Errors While Scanning .....	9-10
Simple Serial Interface Parameter Defaults .....	9-11
SSI Host Parameters .....	9-12
Select SSI Host .....	9-12
Baud Rate .....	9-12
Parity .....	9-14
Check Parity .....	9-15
Stop Bits .....	9-15
Software Handshaking .....	9-16
Host RTS Line State .....	9-17
Decode Data Packet Format .....	9-17
Host Serial Response Timeout .....	9-18
Host Character Timeout .....	9-19
Multipacket Option .....	9-20
Interpacket Delay .....	9-21
Event Reporting .....	9-22
Decode Event .....	9-22

Boot Up Event .....	9-23
Parameter Event .....	9-23
<b>Chapter 10: RS-232 Interface</b>	
Introduction .....	10-1
Setting Parameters .....	10-1
Scanning Sequence Examples .....	10-2
Errors While Scanning .....	10-2
Connecting an RS-232 Interface .....	10-2
RS-232 Parameter Defaults .....	10-3
RS-232 Host Parameters .....	10-4
RS-232 Host Types .....	10-6
Baud Rate .....	10-8
Parity .....	10-9
Stop Bits .....	10-9
Data Bits .....	10-10
Check Receive Errors .....	10-10
Hardware Handshaking .....	10-11
Software Handshaking .....	10-13
Host Serial Response Timeout .....	10-15
RTS Line State .....	10-16
Beep on <BEL> .....	10-16
Intercharacter Delay .....	10-17
Nixdorf Beep/LED Options .....	10-18
Bar Codes with Unknown Characters .....	10-18
ASCII Character Set for RS-232 .....	10-18
<b>Chapter 11: IBM 468X / 469X Interface</b>	
Introduction .....	11-1
Setting Parameters .....	11-1
Scanning Sequence Examples .....	11-1
Errors While Scanning .....	11-2
Connecting an IBM 468X/469X Host .....	11-2
IBM Parameter Defaults .....	11-3
IBM Host Parameters .....	11-4
Port Address .....	11-4
Convert Unknown to Code 39 .....	11-5
RS-485 Beep Directive .....	11-5
RS-485 Bar Code Configuration Directive .....	11-6
IBM-485 Specification Version .....	11-6
<b>Chapter 12: Keyboard Wedge Interface</b>	
Introduction .....	12-1
Setting Parameters .....	12-1
Scanning Sequence Examples .....	12-1
Errors While Scanning .....	12-1
Connecting a Keyboard Wedge Interface .....	12-2
Keyboard Wedge Parameter Defaults .....	12-3
Keyboard Wedge Host Parameters .....	12-4

Keyboard Wedge Host Types .....	12-4
Bar Codes with Unknown Characters .....	12-4
Keystroke Delay .....	12-5
Intra-keystroke Delay .....	12-5
Alternate Numeric Keypad Emulation .....	12-6
Quick Keypad Emulation .....	12-6
Simulated Caps Lock .....	12-7
Caps Lock Override .....	12-7
Convert Case .....	12-8
Function Key Mapping .....	12-8
FN1 Substitution .....	12-9
Send Make and Break .....	12-9
Keyboard Map .....	12-10
ASCII Character Set for Keyboard Wedge .....	12-10

**Chapter 13: Symbologies**

Introduction .....	13-1
Setting Parameters .....	13-1
Scanning Sequence Examples .....	13-2
Errors While Scanning .....	13-2
Symbology Parameter Defaults .....	13-2
Enable/Disable All Code Types .....	13-8
UPC/EAN/JAN .....	13-9
UPC-A .....	13-9
UPC-E .....	13-9
UPC-E1 .....	13-10
EAN-8/JAN-8 .....	13-10
EAN-13/JAN-13 .....	13-11
Bookland EAN .....	13-11
Bookland ISBN Format .....	13-12
ISSN EAN .....	13-12
Decode UPC/EAN/JAN Supplementals .....	13-13
User-Programmable Supplementals .....	13-16
UPC/EAN/JAN Supplemental Redundancy .....	13-16
UPC/EAN/JAN Supplemental AIM ID Format .....	13-17
Transmit UPC-A Check Digit .....	13-18
Transmit UPC-E Check Digit .....	13-18
Transmit UPC-E1 Check Digit .....	13-19
Transmit EAN-8 Check Digit .....	13-19
Transmit EAN-13 Check Digit .....	13-20
UPC-A Preamble .....	13-21
UPC-E Preamble .....	13-22
UPC-E1 Preamble .....	13-23
Convert UPC-E to UPC-A .....	13-24
Convert UPC-E1 to UPC-A .....	13-24
EAN/JAN Zero Extend .....	13-25
UCC Coupon Extended Code .....	13-25
Coupon Report .....	13-26
UPC Reduced Quiet Zone .....	13-26
Code 128 .....	13-27

Set Lengths for Code 128 .....	13-27
GS1-128 (formerly UCC/EAN-128) .....	13-28
ISBT 128 .....	13-29
ISBT Concatenation .....	13-30
Check ISBT Table .....	13-31
ISBT Concatenation Redundancy .....	13-31
Code 128 <FNC4> .....	13-32
Code 128 Security Level .....	13-32
Code 128 Reduced Quiet Zone .....	13-33
Code 39 .....	13-34
Trioptic Code 39 .....	13-34
Convert Code 39 to Code 32 .....	13-35
Code 32 Prefix .....	13-35
Set Lengths for Code 39 .....	13-36
Code 39 Check Digit Verification .....	13-37
Transmit Code 39 Check Digit .....	13-38
Code 39 Full ASCII Conversion .....	13-38
Code 39 Security Level .....	13-39
Code 39 Reduced Quiet Zone .....	13-41
Code 93 .....	13-41
Set Lengths for Code 93 .....	13-42
Code 11 .....	13-44
Set Lengths for Code 11 .....	13-44
Code 11 Check Digit Verification .....	13-46
Transmit Code 11 Check Digits .....	13-47
Interleaved 2 of 5 (ITF/I 2 of 5) .....	13-47
Set Lengths for Interleaved 2 of 5 .....	13-48
I 2 of 5 Check Digit Verification .....	13-50
Transmit I 2 of 5 Check Digit .....	13-51
Convert I 2 of 5 to EAN-13 .....	13-51
Febraban .....	13-52
I 2 of 5 Security Level .....	13-53
I 2 of 5 Reduced Quiet Zone .....	13-54
Discrete 2 of 5 (DTF/D 2 of 5) .....	13-54
Set Lengths for Discrete 2 of 5 .....	13-55
Codabar (NW - 7) .....	13-57
Set Lengths for Codabar .....	13-57
CLSI Editing .....	13-59
NOTIS Editing .....	13-59
Codabar Upper or Lower Case Start/Stop Characters .....	13-60
Codabar Mod 16 Check Digit Verification .....	13-60
Transmit Codabar Check Digit .....	13-61
MSI .....	13-61
Set Lengths for MSI .....	13-62
MSI Check Digits .....	13-64
Transmit MSI Check Digit(s) .....	13-64
MSI Check Digit Algorithm .....	13-65
MSI Reduced Quiet Zone .....	13-65
Chinese 2 of 5 .....	13-66
Matrix 2 of 5 .....	13-66

Set Lengths for Matrix 2 of 5 .....	13-67
Matrix 2 of 5 Check Digit .....	13-68
Transmit Matrix 2 of 5 Check Digit .....	13-69
Korean 3 of 5 .....	13-69
Inverse 1D .....	13-70
GS1 DataBar .....	13-71
GS1 DataBar Omnidirectional (formerly GS1 DataBar-14), GS1 DataBar Truncated, GS1 DataBar	
Stacked, GS1 DataBar Stacked Omnidirectional .....	13-71
GS1 DataBar Limited .....	13-71
GS1 DataBar Expanded, GS1 DataBar Expanded Stacked .....	13-72
Convert GS1 DataBar to UPC/EAN/JAN .....	13-72
GS1 DataBar Limited Margin Check .....	13-73
GS1 DataBar Security Level .....	13-74
Symbology-Specific Security Features .....	13-75
Redundancy Level .....	13-75
Security Level .....	13-77
1D Quiet Zone Level .....	13-78
Intercharacter Gap Size .....	13-79
Composite .....	13-79
Composite CC-C .....	13-79
Composite CC-A/B .....	13-80
Composite TLC-39 .....	13-80
Composite Inverse .....	13-81
UPC Composite Mode .....	13-82
Composite Beep Mode .....	13-83
GS1-128 Emulation Mode for UCC/EAN Composite Codes .....	13-83
2D Symbolologies .....	13-84
PDF417 .....	13-84
MicroPDF417 .....	13-84
Code 128 Emulation .....	13-85
Data Matrix .....	13-86
GS1 Data Matrix .....	13-86
Data Matrix Inverse .....	13-87
Decode Data Matrix Mirror Images .....	13-88
Maxicode .....	13-89
QR Code .....	13-89
GS1 QR .....	13-90
MicroQR .....	13-90
Weblink QR .....	13-91
Linked QR .....	13-92
Aztec .....	13-93
Aztec Inverse .....	13-93
Han Xin .....	13-94
Han Xin Inverse .....	13-94
Grid Matrix .....	13-95
Grid Matrix Inverse .....	13-95
Grid Matrix Mirror .....	13-96
DotCode .....	13-97
DotCode Inverse .....	13-98
DotCode Mirrored .....	13-99

DotCode Prioritize .....	13-100
DotCode Erasure Limit .....	13-100
Escape Characters .....	13-101
Flush Macro PDF Buffer .....	13-101
Abort Macro PDF Entry .....	13-101
Postal Codes .....	13-102
US Postnet .....	13-102
US Planet .....	13-102
Transmit US Postal Check Digit .....	13-103
UK Postal .....	13-103
Transmit UK Postal Check Digit .....	13-104
Japan Postal .....	13-104
Australia Post .....	13-105
Australia Post Format .....	13-106
Netherlands KIX Code .....	13-107
USPS 4CB/One Code/Intelligent Mail .....	13-107
UPU FICS Postal .....	13-108
Mailmark .....	13-108
<b>Chapter 14: Data Formatting: ADF</b>	
Introduction .....	14-1
Advanced Data Formatting (ADF) .....	14-1
<b>Appendix A: Standard Default Parameters</b>	
<b>Appendix B: Country Codes</b>	
Introduction .....	B-1
USB and Keyboard Wedge Country Keyboard Types (Country Codes) .....	B-2
<b>Appendix C: Country Code Pages</b>	
Introduction .....	C-1
Country Code Page Defaults .....	C-1
Country Code Page Bar Codes .....	C-5
<b>Appendix D: CJK Decode Control</b>	
Introduction .....	D-1
CJK Control Parameters .....	D-1
Unicode Output Control .....	D-1
CJK Output Method to Windows Host .....	D-2
Non-CJK UTF Bar Code Output .....	D-4
Unicode/CJK Decode Setup with Windows Host .....	D-5
Setting Up the Windows Registry Table for Unicode Universal Output .....	D-5
Adding CJK IME on Windows .....	D-5
Selecting the Simplified Chinese Input Method on the Host .....	D-6
Selecting the Traditional Chinese Input Method on the Host .....	D-7
<b>Appendix E: Programming Reference</b>	
Symbol Code Identifiers .....	E-1



AIM Code Identifiers ..... E-3

**Appendix F: Sample Bar Codes**

UPC/EAN ..... F-1

    UPC-A, 100% ..... F-1

    UPC-A with 2-digit Add-on ..... F-1

    UPC-A with 5-digit Add-on ..... F-2

    UPC-E ..... F-2

    UPC-E with 2-digit Add-on ..... F-2

    UPC-E with 5-digit Add-on ..... F-3

    EAN-8 ..... F-3

    EAN-13, 100% ..... F-3

    EAN-13 with 2-digit Add-on ..... F-4

    EAN-13 with 5-digit Add-on ..... F-4

Code 128 ..... F-5

    GS1-128 ..... F-5

Code 39 ..... F-5

Code 93 ..... F-6

Code 11 with 2 Check Digits ..... F-6

Interleaved 2 of 5 ..... F-6

MSI with 2 Check Digits ..... F-7

Chinese 2 of 5 ..... F-7

Matrix 2 of 5 ..... F-7

Korean 3 of 5 ..... F-8

GS1 DataBar ..... F-8

    GS1 DataBar Omnidirectional (formerly GS1 DataBar-14) ..... F-8

    GS1 DataBar Truncated ..... F-8

    GS1 DataBar Stacked ..... F-9

    GS1 DataBar Stacked Omnidirectional ..... F-9

    GS1 DataBar Limited ..... F-9

    GS1 DataBar Expanded ..... F-10

    GS1 DataBar Expanded Stacked ..... F-10

2D Symbologies ..... F-11

    PDF417 ..... F-11

    Data Matrix ..... F-11

    GS1 Data Matrix ..... F-11

    Maxicode ..... F-12

    QR Code ..... F-12

    GS1 QR ..... F-12

    MicroQR ..... F-13

    Aztec ..... F-13

    Grid Matrix ..... F-13

    Han Xin ..... F-14

Postal Codes ..... F-14

    US Postnet ..... F-14

    UK Postal ..... F-14

    Japan Post ..... F-15

    Australian Post ..... F-15

**Appendix G: Numeric Bar Codes**

- Numeric Bar Codes ..... G-1
- Cancel ..... G-3

**Appendix H: Alphaumeric Bar Codes**

- Cancel ..... H-1
- Alphanumeric Bar Codes ..... H-2

**Appendix I: ASCII Character Sets**

**Appendix J: Communication Protocol Functionality**

- Functionality Supported via Communication (Cable) Interface ..... J-1

**Appendix K: Signature Capture Code**

- Introduction ..... K-1
- Code Structure ..... K-1
  - Signature Capture Area ..... K-1
  - CapCode Pattern Structure ..... K-2
- Start / Stop Patterns ..... K-2
- Dimensions ..... K-3
- Data Format ..... K-3
- Additional Capabilities ..... K-4
- Signature Boxes ..... K-4

**Appendix L: Non-Parameter Attributes**

- Introduction ..... L-1
- Attributes ..... L-1
  - Model Number ..... L-1
  - Serial Number ..... L-1
  - Date of Manufacture ..... L-2
  - Date of First Programming ..... L-2
  - Configuration Filename ..... L-2
  - Beeper/LED ..... L-3
  - Parameter Defaults ..... L-4
  - Beep on Next Bootup ..... L-4
  - Reboot ..... L-4
  - Host Trigger Session ..... L-4
  - Firmware Version ..... L-5
  - ImageKit Version ..... L-5
  - In Cradle Detect ..... L-5
  - Charging ..... L-5
  - Battery Charge State ..... L-6

**Appendix M: FIRMWARE UPGRADES USING iOS**

- Introduction ..... M-1
- Downloading Firmware Using the Zebra Scanner Control Application ..... M-1

**Appendix N: UPGRADING OVER BLUETOOTH WITHOUT A CRADLE**

Introduction .....	N-1
Upgrading Without a Cradle .....	N-1
Troubleshooting .....	N-2

**Index**

# ABOUT THIS GUIDE

---

## Introduction

The *DS2278 Product Reference Guide* provides general instructions for setting up, operating, maintaining, and troubleshooting the DS2278 series digital scanner.

---

## Configurations

This guide includes the DS2278 series digital scanner configurations listed in [Table A](#).

**Table A:** *Digital Scanner and Cradle Configurations*

Model Configuration	Description
DS2278-SR00006ZZWW	DS2278: Area Imager, Standard Range, Cordless, Nova White
DS2278-SR00007ZZWW	DS2278: Area Imager, Standard Range, Cordless, Twilight Black
DS2278-SR00007ZZY	DS2278: Area Imager, Standard Range, Cordless, Twilight Black - India only
CR2278-PC10004WW	DS2278: Presentation Cradle, Bluetooth, Midnight Black

## Related Product Line Configurations

The product configurations related to the DS2278 digital scanner are as follows.

- ✓ **NOTES** Check Solution Builder for additional information regarding all available accessories, and the latest available configurations.

**Table B:** *Accessories for the Digital Scanner*

Product ID	Description
BTRY-DS22EAB0E-00	Spare Battery, DS2278 Family
BTRY-DS22EAB0E-00Y	Spare Battery, DS2278 Family, India only
25-MCXUSB-01R	Micro USB Charge Only Cable

### Cables

The full list of supported cables can be found at:

[partnerportal.zebra.com/PartnerPortal/product\\_services/downloads\\_z/barcode\\_scanners/Universal-Cable-Guide-Bar-Code-Scanners.xlsx](http://partnerportal.zebra.com/PartnerPortal/product_services/downloads_z/barcode_scanners/Universal-Cable-Guide-Bar-Code-Scanners.xlsx).

## Chapter Descriptions

Topics covered in this guide are as follows:

- [Chapter 1, Getting Started](#) provides a product overview, unpacking instructions, and cable connection information.
- [Chapter 2, 123Scan and Software Tools](#) provides a brief description of the Zebra software tools available for customizing digital scanner operation.
- [Chapter 3, Data Capture](#) provides beeper and LED definitions, techniques involved in scanning bar codes, general instructions and tips about scanning, and decode ranges.
- [Chapter 4, Maintenance, Troubleshooting, & Technical Specifications](#) provides suggested digital scanner maintenance, troubleshooting, technical specifications, and signal descriptions (pin outs).
- [Chapter 6, Radio Communications](#) provides information about the modes of operation and features available for wireless communication. This chapter also includes programming bar codes to configure the digital scanner.
- [Chapter 5, User Preferences & Miscellaneous Options](#) describes each user preference feature and provides programming bar codes for selecting these features.
- [Chapter 8, USB Interface](#) describes how to set up the digital scanner with a USB host.
- [Chapter 9, SSI Interface](#) describes the system requirements of the Simple Serial Interface (SSI), which provides a communications link between Zebra decoders and a serial host.
- [Chapter 10, RS-232 Interface](#) describes how to set up the digital scanner with an RS-232 host.
- [Chapter 11, IBM 468X / 469X Interface](#) describes how to set up the digital scanner with an IBM 468X/469X host.
- [Chapter 12, Keyboard Wedge Interface](#) describes how to set up a keyboard wedge interface with the digital scanner.

- [Chapter 13, Symbologies](#) describes all symbology features and provides programming bar codes for selecting these features for the digital scanner.
- [Chapter 14, Data Formatting: ADF](#) briefly describes the Zebra features available for customizing scanner operation.
- [Appendix A, Standard Default Parameters](#) provides a table of all host devices and miscellaneous digital scanner defaults.
- [Appendix B, Country Codes](#) provides bar codes for programming the country keyboard type for the USB keyboard (HID) device and the keyboard wedge host.
- [Appendix C, Country Code Pages](#) provides bar codes for selecting code pages for the country keyboard type.
- [Appendix D, CJK Decode Control](#) describes control parameters for Unicode/CJK (Chinese, Japanese, Korean) bar code decode through USB HID Keyboard Emulation mode.
- [Appendix E, Programming Reference](#) provides a table of AIM code identifiers, ASCII character conversions, and keyboard maps.
- [Appendix F, Sample Bar Codes](#) includes sample bar codes of various code types.
- [Appendix G, Numeric Bar Codes](#) includes the numeric bar codes to scan for parameters requiring specific numeric values.
- [Appendix H, Alphaumeric Bar Codes](#) includes the alphanumeric bar codes to scan for parameters requiring specific alphanumeric values.
- [Appendix I, ASCII Character Sets](#) provides ASCII character value tables.
- [Appendix J, Communication Protocol Functionality](#) lists supported digital scanner functionality by communication protocol.
- [Appendix K, Signature Capture Code](#) describes CapCode, a special pattern that encloses a signature area on a document and allows the digital scanner to capture a signature.
- [Appendix L, Non-Parameter Attributes](#) defines non-parameter attributes.

---

## Notational Conventions

The following conventions are used in this document:

- Unless stated otherwise, **DS2278** refers to all configurations.
- *Italics* are used to highlight the following:
  - Chapters and sections in this and related documents
  - Dialog box, window and screen names
  - Drop-down list and list box names
  - Check box and radio button names
- **Bold** text is used to highlight the following:
  - Key names on a keypad
  - Button names on a screen.

- bullets (•) indicate:
  - Action items
  - Lists of alternatives
  - Lists of required steps that are not necessarily sequential
- Sequential lists (e.g., those that describe step-by-step procedures) appear as numbered lists.
- Throughout the programming bar code menus, asterisks (\*) are used to denote default parameter settings.



\* Indicates Default — \* Baud Rate 9600 — Feature/Option

---

## Related Documents

- *DS2278 Series Quick Start Guide*, p/n MN-002916-xx - provides general information for getting started with the DS2278 digital scanner, and includes basic set up and operation instructions.
- *Advanced Data Formatting Programmer Guide*, p/n 72E-69680-xx - provides information on ADF, a means of customizing data before transmission to a host.
- *Attribute Data Dictionary*, p/n 72E-149786-xx defines attribute numbers (device configuration parameters, monitored data, and born-on information) and describes management of various attribute domains for bar code scanners and OEM engines.

For the latest version of this guide and all guides, go to: [www.zebra.com/support](http://www.zebra.com/support).

---

## Service Information

If you have a problem using the equipment, contact your facility's technical or systems support. If there is a problem with the equipment, they will contact the Zebra Support & Downloads website at: [www.zebra.com/support](http://www.zebra.com/support).

When contacting support, please have the following information available:

- Serial number of the unit
- Model number or product name
- Software type and version number

Zebra responds to calls by e-mail, telephone or fax within the time limits set forth in service agreements.

If your problem cannot be solved by support, you may need to return your equipment for servicing and will be given specific directions. Zebra is not responsible for any damages incurred during shipment if the approved shipping container is not used. Shipping the units improperly can possibly void the warranty.

If you purchased your business product from a Zebra business partner, please contact that business partner for support.

---

## Provide Documentation Feedback

If you have comments, questions, or suggestions about this guide, send an email to [EVM-Techdocs@zebra.com](mailto:EVM-Techdocs@zebra.com).

# CHAPTER 1 GETTING STARTED

---

## Introduction

2D bar codes have made their way to the Point of Sale (POS), appearing on everything from customer purchased items to printed and electronic coupons and loyalty cards. 1D scanners cannot capture the new 2D codes, leading to exceptions that slow down the check-out process. The DS2278 digital imager scanner scans both 1D and 2D bar codes and does not compromise performance or features.

The DS2278 is easy to deploy, easy to use, and easy to manage - delivering affordable simplicity with its hands-free/hand-held design.

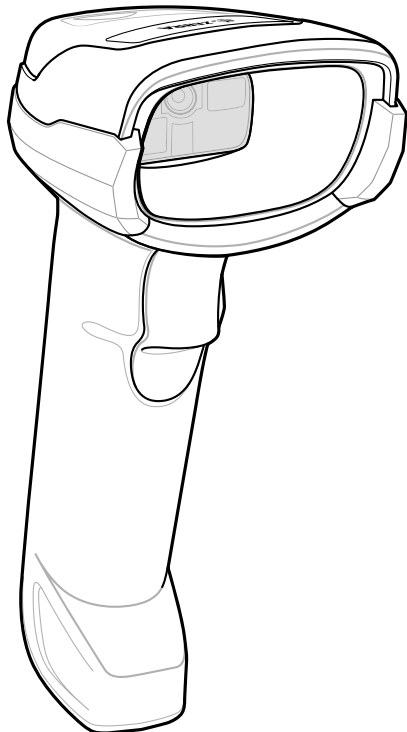

**Figure 1-1** *DS2278 Digital Scanner*



---

## Interfaces

The DS2278 digital scanner cradle supports:

- USB connection to a host. The digital scanner automatically detects the USB host interface type and uses the default setting (**USB Keyboard HID**). If the default (\*) does not meet your requirements, select another USB interface type by scanning programming bar code menus. See [Appendix B, Country Codes](#) for the interface supported international keyboards (for Windows® environment).
- Standard RS-232 connection to a host. The digital scanner automatically detects the RS-232 host interface type and uses the default setting (**Standard RS-232**). If the default (\*) does not meet your requirements, select another RS-232 interface type by scanning programming bar code menus.
- Connection to IBM 468X/469X hosts. The digital scanner automatically detects the IBM host interface type but does not select a default setting. Scan bar code menus to set up communication of the digital scanner with the IBM terminal.
- Keyboard Wedge connection to a host. The host interprets scanned data as keystrokes. The digital scanner automatically detects the Keyboard Wedge host interface type and uses the default setting (**IBM AT Notebook**). If the default (\*) does not meet your requirements, scan *IBM PC/AT & IBM PC Compatibles on page 12-4*. See [Appendix B, Country Codes](#) for the interface supported international keyboards (for Windows® environment).
- Configuration via 123Scan.

✓ **NOTE** For a list of supported digital scanner functionality by communication protocol, see [Appendix J, Communication Protocol Functionality](#).

---

## Unpacking

Remove the digital scanner from its packing and inspect it for damage. If the digital scanner was damaged in transit, contact support. See [page xxii](#) for information. **KEEP THE PACKING**. It is the approved shipping container; use this to return the equipment for servicing.

## DS2278 Features



**IMPORTANT** **DO NOT** use the CR2278-PC cradle with any scanners other than the DS2278 digital scanner. No other cradles are compatible with the DS2278.

**DO NOT** use the DS2278 digital scanner with any cradles other than the CR2278-PC cradle. No other scanners are compatible with the CR2278-PC cradle.

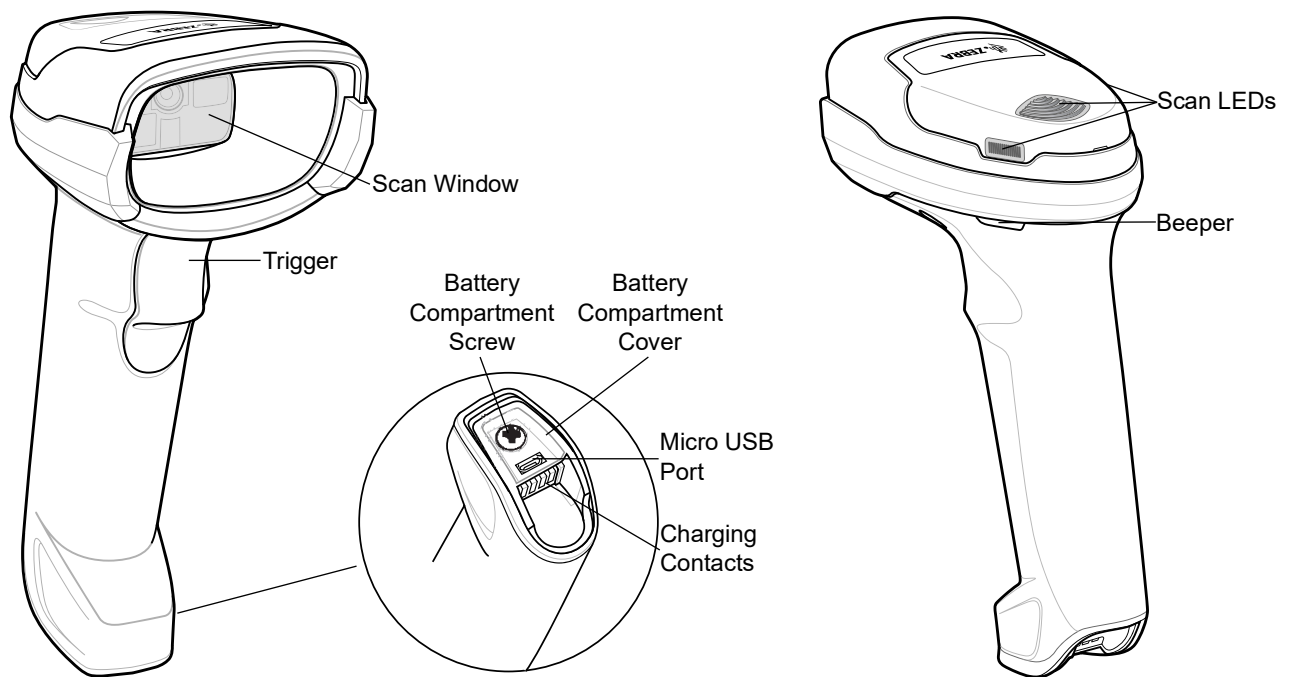

**Figure 1-2** Digital Scanner Features

For detailed LED indicator information see *Beeper and LED Indications on page 3-1*.

## Cradle Features

- ✓ **NOTE** For detailed information about connecting, using, and mounting the CR2278-PC cradle refer to the documentation included with the cradle (*CR2278-PC Presentation Cradle Quick Reference Guide*, p/n MN-002917xx).

The CR2278-PC cordless presentation cradle serves as a charger, radio communication interface, and host communication interface for the DS2278 cordless digital scanner.

The presentation cradle sits on a desktop and charges the DS2278 cordless digital scanner while allowing bar code scanning in presentation mode. This cradle also provides host communication by receiving digital scanner data via a Bluetooth radio, and sending that data to the host through an attached cable. The cable provides power to the cradle from the host or optional power supply if supported.

For more information about communication between the digital scanner, cradle, and host, see [Chapter 6, Radio Communications](#).

## Presentation Cradle

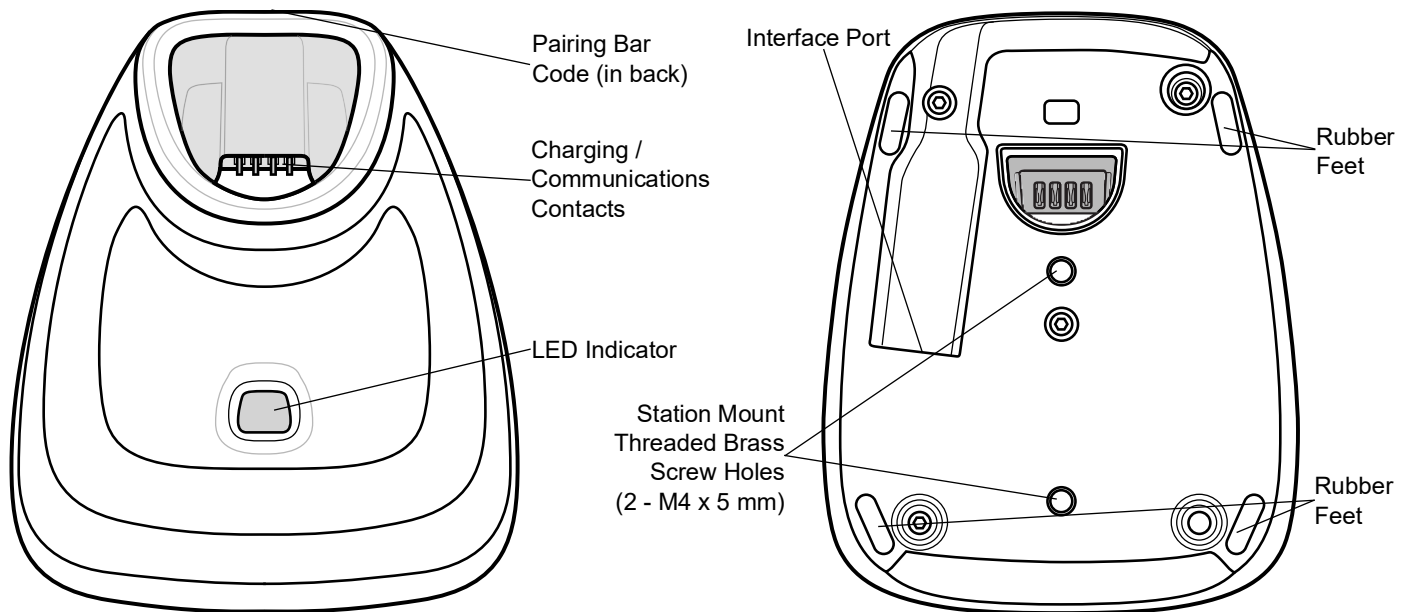

Figure 1-3 CR2278-PC (Presentation Cradle) -Top and Bottom Views

## Connecting the Cradle

### Via Host Connection (for Charging and Communication)

1. Connect the appropriate cable to the power supply and an AC power source, if necessary. This ensures detection of the host and prevents inadvertently back powering the cradle from improper detection of the host.
2. Insert the interface cable into the host port.
3. Insert the interface cable into the cradle's host port.
4. Pair the digital scanner to the cradle either by inserting it in the cradle (if Pair on Contacts is enabled) or by scanning the pairing bar code.
5. If necessary, scan the appropriate host bar code (for non-autodetected interfaces).

### Via Wall Outlet Using a Power Adapter (for Charging Only)

1. Connect the appropriate cable to the power supply and an AC power source.
2. Insert the interface cable into the cradle's host port.
3. Pair the digital scanner directly to the host device (PC, Smartphone, or Tablet).

## Changing the Host Interface

To connect to a different host, or to the same host through a different cable:

1. Unplug the interface cable from the host.
2. Unplug the power supply from the host cable, if required.
3. Connect the interface cable to the new host, or the new interface cable to the existing host.
4. Reconnect the power supply, if required.
5. If necessary, scan the appropriate host bar code (for non-autodetected interfaces).

## Using a DC Power Supply

There is no separate power jack on the cradle. The cradle can operate from host supplied power, if available. If host power is limited or not available, an external DC power supply can be used with certain host interface cables that support a power jack. An external power supply is recommended if fastest charging is required. See host interface chapters for connections.



**CAUTION** Always disconnect the DC power supply BEFORE disconnecting the cable to the host end or the cradle may not recognize the new host.

---

## Charging the DS2278 Battery

When using a new battery in the DS2278, the battery may require a charge to be enabled. See [Charging the DS2278 Battery on page 1-5](#).



### NOTES

1. It is recommended to fully charge the battery before first use.
2. Charge time depends on the host type and power source.
3. The CR2278-PC passes 5V to the digital scanner which charges the battery. The charging system on the DS2278 charges the battery with as much current as possible based on the power source of the CR2278-PC. This way the input power source is never overloaded and the charge time is made as short as possible. Charge times lengthen as scanning activity increases when a DS2278 operates in presentation mode on a CR2278-PC cradle. To optimize charge performance, ensure the digital scanner is oriented to minimize accidental scan activation.



### CAUTION

The battery does not charge when the temperature is above 40°C (104°F). When scanning in presentation mode at temperatures above 40°C (104°F), the battery drains until the temperature drops. When the battery charge is consumed the digital scanner stops scanning until the temperature drops and the battery has sufficient time to charge.

To avoid temperature related faults, charge the battery and operate the DS2278 in presentation mode on a CR2278-PC only within the recommended 0°C to 40°C (32°F to 104°F) range, and ideally within 5°C to 35°C (41°F to 95°F).

## Charging Using the Cradle

Insert the battery in the DS2278 and place the DS2278 in the CR2278-PC cradle (see [Inserting the Digital Scanner in the Cradle on page 1-9](#)). The digital scanner boots and the cradle LED begins flashing green to indicate the start of normal charging.

See [Beeper and LED Indications on page 3-1](#) for detailed LED indicator information.

## Charging Using the Micro USB Cable

The Micro USB cable is a charge only cable.

✓ **NOTE** For best performance, we recommend using Zebra accessories.

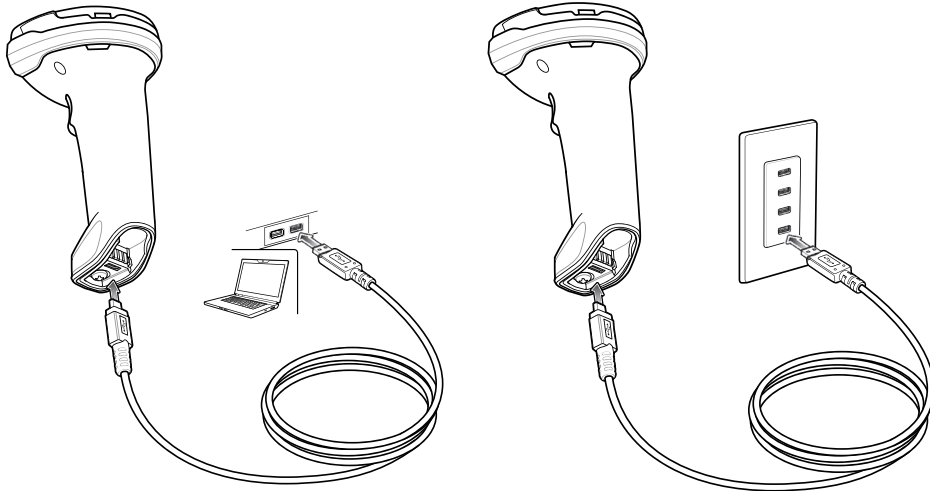

**Figure 1-4** *Micro USB Connections*

Connect the Micro USB connector to the DS2278. Connect the standard USB connector to a PC or a USB wall outlet. The digital scanner enumerates as a CDC device when the USB connector is plugged into a PC host. When charging begins, the digital scanner LED begins flashing green to indicate the start of normal charging.

### Converting a CDC Device to HID

The digital scanner enumerates over USB as a CDC device, by default. If your host does not have a CDC driver, a delay occurs between connecting the digital scanner to the host and the start of charging. To eliminate the delay scan **HID Device Conversion** below to enumerate as an HID device. This allows the scanner to begin charging sooner.

To switch the digital scanner back to a CDC device, scan **Scanner as CDC Device** below.

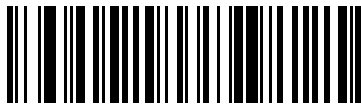

**HID Device Conversion**



**\*Scanner as CDC Device**

For instructions on downloading CDC drivers see [page 8-6](#).

---

## Shutting Off the Digital Scanner Battery

Scan the **Battery Off** bar code below to shut off the battery for long term storage or shipping. Pull the digital scanner trigger to turn on the battery.

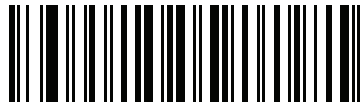

**Battery Off**

- ✓ **NOTE** Always scan the **Battery Off** bar code in hand-held mode. Also see *Battery Preservation Mode* on page 5-15 for additional battery features.

---

## Inserting the Battery

✓ **NOTES**

1. It is recommended to fully charge the battery before first use.
2. The battery is initially shipped inside the digital scanner. Inserting a battery would only be applicable for a replacement battery.

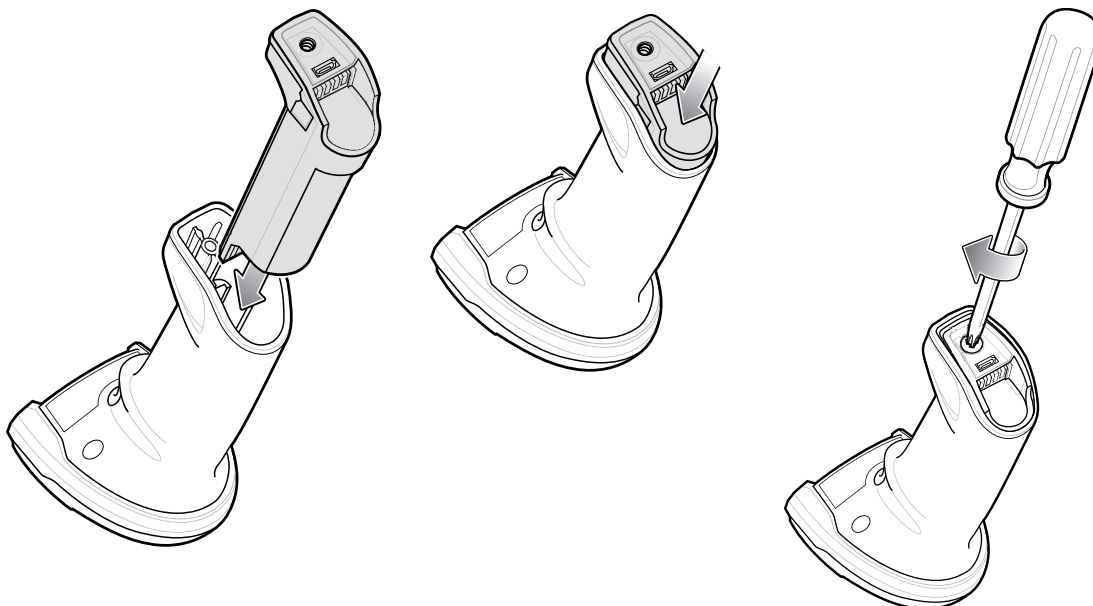

**Figure 1-5** *Inserting the Battery*

To insert the battery into the digital scanner:

1. Insert the battery into the battery compartment and push down.
2. Turn the screw on the battery compartment clockwise to tighten. Do not over torque the screw.

---

## Removing the Battery



**IMPORTANT** When replacing the battery, wait at least 5 seconds after removing the old battery before inserting the new battery.

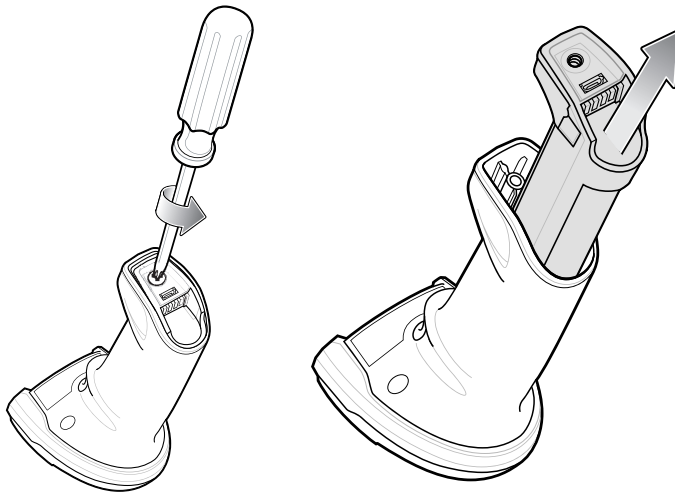

**Figure 1-6** *Removing the Battery from the Digital Scanner*

To remove the battery from the digital scanner:

1. Turn the screw on the battery compartment counterclockwise to remove the screw.
2. Remove the battery from the battery compartment.
3. To replace the battery, see [Inserting the Battery on page 1-7](#).

---

## Inserting the Digital Scanner in the Cradle

To insert the digital scanner in the CR2278-PC cradle:

1. Insert the digital scanner straight down into the cradle top.
2. The digital scanner naturally rotates forward to engage the digital scanner contacts with the cradle contacts

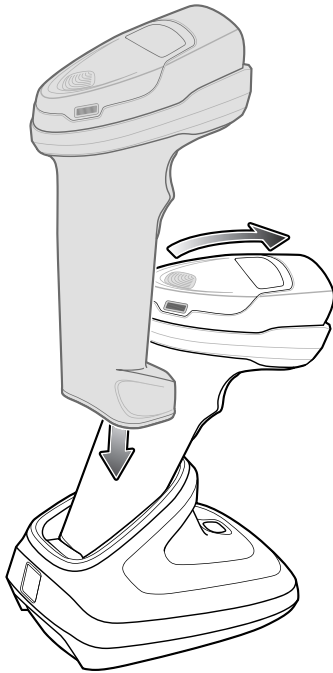

Figure 1-7 Inserting the Digital Scanner in the CR2278-PC Cradle

---

## Sending Data to the Host Computer

The cradle receives data from the digital scanner via a wireless radio connection and transmits it to the host computer via the host cable. The digital scanner and cradle must be paired for successful wireless communication.

### Pairing

Pairing registers a digital scanner to the cradle such that the digital scanner and cradle can exchange information. Pair the digital scanner to the cradle either by inserting it in the cradle (if pair on contacts is enabled), or by scanning the pairing bar code.

To pair the digital scanner with the cradle, insert the digital scanner in the cradle or scan the pairing bar code. (Pairing on insertion into the cradle is enabled by default. See *Pairing Methods on page 6-28*.)



**NOTE** The pairing bar code that connects the digital scanner to a cradle is unique to each cradle.

Do not scan data or parameters until pairing completes.



### Lost Connection to Host

If scanned data does not transmit to the cradle's host, ensure that all cables are firmly inserted and the power supply is connected to an appropriate AC outlet, if applicable. If scanned data still does not transmit to the host, reestablish a connection with the host:

1. Disconnect the power supply from the cradle.
2. Disconnect the host interface cable from the cradle.
3. Wait three seconds.
4. Reconnect the host interface cable to the cradle.
5. Reconnect the power supply to the cradle, if the host requires.
6. Reestablish pairing with the cradle by inserting the digital scanner in the cradle or scan the pairing bar code. (Pairing on insertion into the cradle is enabled by default. See *Pairing Methods on page 6-28.*)

---

## Configuring the Digital Scanner

Use the bar codes in this manual or the 123Scan configuration program to configure the digital scanner. See [Chapter 5, User Preferences & Miscellaneous Options](#) and each host chapter for information about programming the digital scanner using bar code menus. See [Chapter 2, 123Scan and Software Tools](#) to configure the digital scanner using this configuration program. 123Scan includes a help file.

---

## Radio Communications

The digital scanner can communicate with remote devices via Bluetooth, or by pairing with a cradle. For radio communication parameters, detailed information about operational modes, Bluetooth and pairing, see [Chapter 6, Radio Communications](#).

---

## Accessories

The digital scanner ships with the battery installed and the *DS2278 Quick Start Guide*. The following accessories must be ordered separately:

- Cradle: Can be used for charging the digital scanner battery and host communication (see [Presentation Cradle on page 1-4](#)).
- Micro USB cable: Can be used for charging the battery in the digital scanner, without a cradle.
- Replacement battery for the DS2278 digital scanner, if needed.
- Interface cable for the appropriate interface.
- Power supply, if the interface requires one.

See [Related Product Line Configurations on page xx](#) for the full list of accessories. Also see [Configurations on page xix](#) for product and cradle configurations. For additional items, contact a local Zebra representative or business partner.

# CHAPTER 2 123SCAN AND SOFTWARE TOOLS

---

## Introduction

This chapter briefly describes the Zebra software tools available for customizing scanner operation.

---

## 123Scan

123Scan is a software tool that simplifies scanner setup and more.

Intuitive enough for first time users, the 123Scan wizard guides users through a streamlined setup process. Settings are saved in a configuration file that can be printed as a single programming bar code for scanning, emailed to a smart phone for scanning from its screen, or downloaded to the scanner using a USB cable.

Through 123Scan a user can accomplish the following.

- Configure a scanner using a wizard.
  - Program the following scanner settings:
    - Beeper tone / volume settings.
    - Enable / disable symbologies.
    - Communication settings.
  - Modify data before transmission to a host using:
    - Advanced Data Formatting (ADF) - Scan one bar code per trigger pull.
  - Load parameter settings to a scanner via:
    - Bar code scanning.
      - Scan a paper bar code.
      - Scan a bar code from a PC screen.
      - Scan a bar code from a smart phone screen.
  - Download over a USB cable:
    - Load settings to one scanner.
    - Stage up to 10 scanners simultaneously (Powered USB Hub recommended with 0.5 amp / port).

- Validate scanner setup:
  - View scanned data within the utility's Data View screen.
  - Review settings using the Parameter Report.
  - Clone settings from an already deployed scanner from the start screen.
- Upgrade scanner firmware:
  - Stage up to 10 scanners simultaneously (Powered USB Hub recommended with 0.5 amp / port).
  - Upgrade firmware
    - Over a USB cable
    - Over a Bluetooth connection (no cradle required)
- View statistics such as:
  - Asset tracking information.
  - Time and usage information.
  - Bar codes scanned by symbology.
- Generate the following reports:
  - Bar Code Report - Programming bar code, included parameter settings, and supported scanner models.
  - Parameter Report - Lists parameters programmed within a configuration file.
  - Inventory Report - Lists scanner asset tracking information.
  - Validation Report - Printout of scanned data from the Data view.
  - Statistics Report - Lists all statistics retrieved from the scanner.

For more information go to: [www.zebra.com/123Scan](http://www.zebra.com/123Scan).

### Communication with 123Scan

Use a USB cable to connect the scanner to a Windows host computer running 123Scan.

### 123Scan Requirements

- Host computer with Windows 7, 8, or 10
- Scanner

### 123Scan Information

For more information on 123Scan, go to: [www.zebra.com/123Scan](http://www.zebra.com/123Scan).

For a 1 minute tour of 123Scan, go to: [www.zebra.com/ScannerHowToVideos](http://www.zebra.com/ScannerHowToVideos).

To see a list of all of our free software tools, go to: [www.zebra.com/scannersoftware](http://www.zebra.com/scannersoftware).

---

## Scanner SDK, Other Software Tools, and Videos

To tackle all scanner programming needs, use Zebra's diversified set of software tools. Whether staging a device or developing a fully featured application with image and data capture, as well as asset management, these tools help you every step of the way. To download any of the following free tools, go to:

[www.zebra.com/scannersoftware](http://www.zebra.com/scannersoftware).

- 123Scan configuration utility
- SDKs
  - Scanner SDK for Windows
  - Scanner SDK for Linux
  - Scanner SDK for Android
  - Scanner SDK for iOS
- Drivers
  - OPOS driver
  - JPOS driver
  - USB CDC driver
  - TWAIN driver
- Scanner Management Service (SMS) for Remote Management
  - Windows
  - Linux
- Mobile Apps
  - Scanner Control App
    - Android
    - iOS
    - Zebra AppGallery
  - Scan-To-Connect Utility
    - Android
    - Windows
- How-To-Videos

✓ **NOTE** For a list of SDK supported scanner functionality by communication protocol, see [Appendix J, Communication Protocol Functionality](#).

---

## Scanner Control App

The Scanner Control App (SCA) allows you to control a Bluetooth scanner from a phone or tablet without a cradle. Use this app to showcase Zebra Bluetooth scanner capabilities and ease of control right from your phone.

The Scanner Control App supports Scan-To-Connect technology for one-step Bluetooth pairing and allows you to control the following scanner functions:

- Program the beeper and LEDs
- Enable and disable symbologies
- Remotely trigger a scan

The app displays scanned bar code data, and can query scanner asset information and battery health statistics.

The Scanner Control App also works with USB connected scanners like the MP7000, assuming your Android tablet has a powered USB host port.

The Scanner Control app is available on the Android Play, iOS App, and Zebra AppGallery stores. Source code is available within the Zebra Scanner SDK for Android and iOS.

To watch a 1 minute tour of the Scanner Control App, go to: [www.zebra.com/scannercontrolapp](http://www.zebra.com/scannercontrolapp).

---

## Scan-To-Connect (STC) Utility

In one step, connect a Zebra Bluetooth scanner to a phone, tablet or PC by simply scanning an STC bar code. Available as a standalone utility for Windows and Android operating systems from [www.zebra.com/scantoconnect](http://www.zebra.com/scantoconnect).

Source code is also available for easy app integration.

✓ **NOTE** The STC utility allows you to pair a Bluetooth scanner to a phone, tablet or PC without using a cradle.

# CHAPTER 3 DATA CAPTURE

---

## Introduction

This chapter provides beeper and LED definitions, techniques involved in scanning bar codes, general instructions and tips about scanning, and decode ranges.

---

## Beeper and LED Indications

The digital scanner issues different beep sequences/patterns and an LED display to indicate status. [Table 3-1](#) defines beep sequences/patterns and LED displays which occur during both normal scanning and while programming the digital scanner.

### Digital Scanner Indications

**Table 3-1** *Digital Scanner Beeper and LED Indications*

Beeper Sequence	LED	Indication
<b>Standard Use</b>		
Low/medium/high beeps	Green	Power up.
<b>Scanning</b>		
None	Green solid	Presentation Mode on.
None	No LED; green LED is turned off	Presentation Mode off.
Medium beep (or as configured)	Green flash	A bar code was successfully decoded. (See <i>User Preferences/Miscellaneous Options Parameter Defaults on page 5-2</i> for programming beeper sounds.)
Low/low/low/extra low beeps	Red	Parity error.

**Table 3-1** Digital Scanner Beeper and LED Indications (Continued)

Beeper Sequence	LED	Indication
Four long low beeps	Red	A transmission error was detected in a scanned symbol. The data is ignored. This occurs if a unit is not properly configured. Check option setting.
Five long low beeps	Red	Conversion or format error.
None	Red (fast blink)) on trigger pull	Digital scanner is disabled by a host command to the digital scanner.
High	None	A <BEL> character is received over RS-232.
None	Single green flash	Scanner dock in the cradle.
<b>Wireless Operation</b>		
Low, high, low, high	Red	Out of batch storage memory, unable to store new bar code.
<b>Radio Indications</b>		
Low	None	Digital scanner inserted into a cradle (may be disabled).
Low, high	Green	Bluetooth connection established.
High, low	Red	Bluetooth disconnection event.
Long low, long high	Red	Bluetooth page timeout; remote device is out of range/not powered.
Long low, long high, long low, long high	None	Bluetooth connection attempt was rejected by remote device.
None	Green (fast blink)	Bluetooth attempting reconnection.
Five high	Green (fast blink)	Bluetooth attempting reconnection (default is disable).
None	Green (fast blink)	Digital scanner placed into limited discoverable mode.
High, Low, High, Low	Green	Pairing bar code scanned.
<b>Battery Indications</b>		
Four short high beeps	Red (stays on for 4 seconds)	Low battery indication (on trigger release).
None	Solid green	Digital scanner is charging.
None	Red (solid)	Digital scanner charging error occurred.
<b>Battery Indications - Micro USB Only</b>		
None	Green (fast continuous blink)	Digital scanner is charging.
None	Green (solid)	Digital scanner is fully charged.
None	Single green flash	Initial connection.
None	Red (solid)	Charge error.

**Table 3-1** Digital Scanner Beeper and LED Indications (Continued)

Beeper Sequence	LED	Indication
<b>Parameter Programming</b>		
Long low/long high beeps	Red	Input error, incorrect bar code or <b>Cancel</b> scanned, wrong entry, incorrect bar code programming sequence; remain in program mode.
High/low beeps	Green	Keyboard parameter selected. Enter value using bar code keypad.
High/low/high/low beeps	Green	Successful program exit with change in the parameter setting.
<b>ADF Programming</b>		
Low/high/low beeps	None	ADF transmit error.
High/low beeps	Green	Number expected. Enter another digit. Add leading zeros to the front if necessary.
Low/low beeps	Green	Alpha expected. Enter another alphabetic character or scan the <b>End of Message</b> bar code.
High/high beeps	Green blinking	ADF criteria or action is expected. Enter another criteria or action or scan the <b>Save Rule</b> bar code.
High/low/low beeps	Green	All criteria or actions cleared for current rule, continue entering rule.
High/low/high/low beeps	Green (turns off blinking)	Rule saved. Rule entry mode exited.
Long low/long high beeps	Red	Rule error. Entry error, wrong bar code scanned, or criteria/action list is too long for a rule. Re-enter criteria or action.
Low beep	Green	Deleted last saved rule. The current rule is left intact.
Low/high/high beeps	Green	All rules deleted.
Long low/long high/long low/long high beeps	Red	Out of rule memory. Erase some existing rules, then try to save rule again.
Long low/long high/long low beeps	Green (turns off blinking)	Cancel rule entry. Rule entry mode exited because of an error or the user asked to exit rule entry.
<b>Macro PDF</b>		
Two low beeps	None	File ID error. A bar code not in the current MPDF sequence was scanned.
Two long low beeps	None	File ID error. A bar code not in the current MPDF sequence was scanned.
Three long low beeps	None	Out of memory. There is not enough buffer space to store the current MPDF symbol.



**Table 3-1** Digital Scanner Beeper and LED Indications (Continued)

Beeper Sequence	LED	Indication
Four long low beeps	None	Bad symbology. Scanned a 1D or 2D bar code in a MPDF sequence, a duplicate MPDF label, a label in an incorrect order, or trying to transmit an empty or illegal MPDF field.
Five long low beeps	None	Flushing MPDF buffer.
Fast warble beep	None	Aborting MPDF sequence.
Low/high beeps	None	Flushing an already empty MPDF buffer.
<b>Host Specific</b>		
<b>USB only</b>		
Four high beeps	None	Digital scanner has not completed initialization. Wait several seconds and scan again.
<b>RS-232 only</b>		
High/high/high/low beeps	Red	RS-232 receive error.
High beep	None	A <BEL> character is received when Beep on <BEL> is enabled.
<b>Host Controlled Digital Scanner LEDs</b>		
None	Green (slow blink)	Digital scanner connected to 123Scan.
None	Red (fast blink)	File being transferred to the digital scanner (parameters and firmware).
None	Red (slow blink)	Firmware being activated on the digital scanner, loaded into memory.
None	Green (solid)	Programming completed successfully (parameters and firmware).
None	Red (blink)	Loading the SMS package to the digital scanner.
None	Red (solid)	Error state.

## Cradle LED Indications

**Table 3-2** *Cradle LED Indications*

LED	Indication
<b>Standard Use</b>	
Green (solid)	Power up.
Green (off, then on)	Bluetooth connection established.
Red (blink)	Transmission error.
<b>Charging</b>	
Amber (blink)	Charging.
Green (solid)	Fully charged.
Amber (fast blink)	Charging error.
<b>Maintenance</b>	
Red (solid)	Enter boot loader.
Red (blink)	Firmware installation.

[Table 3-3](#) lists the conditions in which the specified host controls the System Indicator LED.

**Table 3-3** *Host Controlled Cradle LED Indications*

LED	Indication
<b>123Scan</b>	
Slow Blinking Green	Digital scanner connected to 123Scan.
Fast Blinking Red	File being transferred to the digital scanner (parameters and firmware).
Slow Blinking Red	Firmware activated on the digital scanner, loaded into memory.
Solid Green	Programming completed successfully (parameters and firmware).
Solid Red	Error state.
<b>SMS</b>	
Blinking Red (Both digital scanner and cradle)	Loading the SMS package to digital scanner.

---

## Scanning

### Hand-Held Scanning

1. Place the aiming pattern over the bar code.

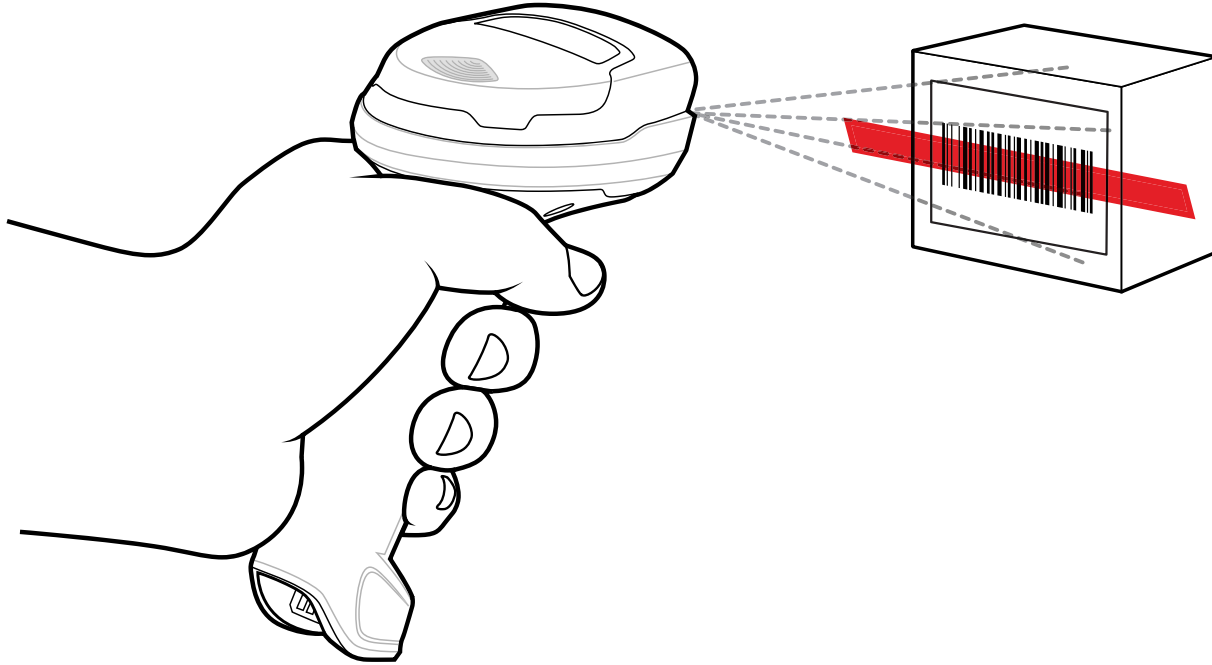

**Figure 3-1** *Aiming Pattern on Bar Code - Hand-Held Mode*

2. Press and hold the trigger until either:
  - a. The digital scanner reads the bar code. The digital scanner beeps, the LED flashes, and the scan line turns off.
  - Or
  - b. The digital scanner does not read the bar code and the scan line turns off.
3. Release the trigger.

## Hands-Free Scanning

The digital scanner is in hands-free (presentation) mode when it sits in the CR2278-PC cradle. During idle conditions the digital scanner operates in object detection mode, where it automatically wakes up to decode a bar code presented in the field of view. In object detection mode it is normal for the illumination LEDs to be dimly lit.

To scan:

1. Ensure all connections are secure (see appropriate host chapter).
2. Present the bar code in the digital scanner field of view.
3. Upon successful decode, the digital scanner beeps and the LED flashes green. (For more information about beeper and LED definitions, [Beeper and LED Indications on page 3-1](#)).

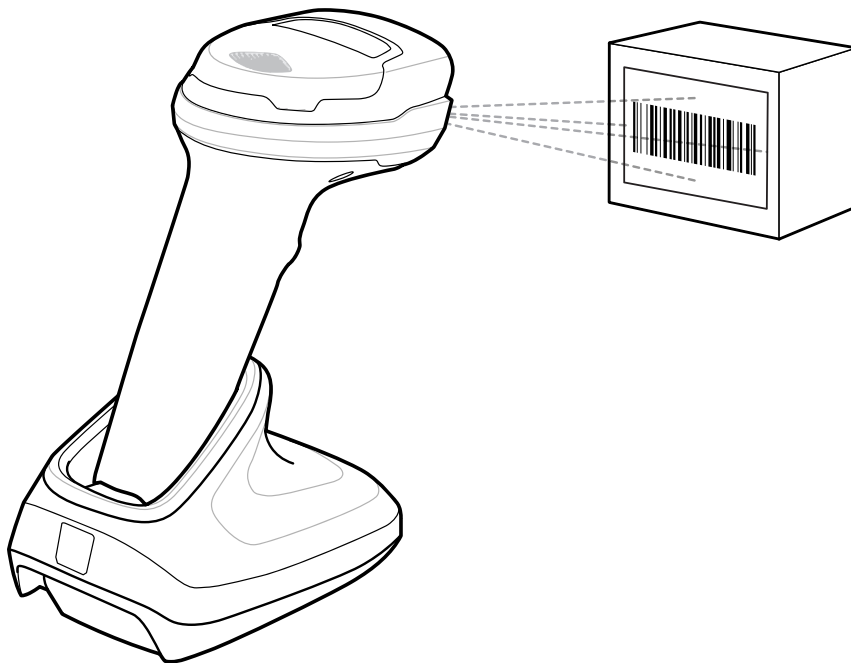

**Figure 3-2** Aiming Pattern on Bar Code - Hands-Free Mode

## Aiming with Digital Scanner

### Aiming

When scanning, the digital scanner projects a red scan line which allows positioning the bar code within its field of view, omnidirectionally. See [Decode Ranges on page 3-8](#) for the proper distance to achieve between the digital scanner and a bar code.



**Figure 3-3** Scanning Orientation with Aiming Line

The aiming line is smaller when the digital scanner is closer to the symbol and larger when it is farther from the symbol. Scan symbols with smaller bars or elements (mil size) closer to the digital scanner, and those with larger bars or elements (mil size) farther from the digital scanner.

The digital scanner beeps to indicate that it successfully decoded the bar code. For more information see [Table 3-1 on page 3-1](#).

## Decode Ranges

**Table 3-4** DS2278 Typical Decode Ranges

Bar Code Type	Symbol Density	DS2278 Typical Working Ranges	
		Near (in/cm)	Far (in/cm)
Code 39	5 mil	.2 in/.5 cm	6.0 in/15.2 cm
Code 39	10 mil	.0 in/.0 cm	13.0 in/33.0 cm
Code 128	5 mil	.6 in/1.5 cm	4.0 in/10.1 cm
Code 128	7.5 mil	.0 in/.0 cm	7.0 in/17.8 cm
PDF417	6.7 mil	.8 in/2.0 cm	5.7 in/14.5 cm
UPC	13 mil (100%)	.5 in/1.3 cm	14.5 in/36.8 cm
Data Matrix	10 mil	.3 in/.8 cm	6.2 in/15.7 cm
QR	20 mil	.0 in/.0 cm	11.0 in/27.9 cm

\* Printing resolution, contrast, and ambient light dependent.

# CHAPTER 4 MAINTENANCE, TROUBLESHOOTING, & TECHNICAL SPECIFICATIONS

---

## Introduction

This chapter provides suggested digital scanner maintenance, troubleshooting, technical specifications, and signal descriptions (pinouts).

---

## Maintenance



**IMPORTANT** Use pre-moistened wipes and do not allow liquid cleaner to pool.

### Known Harmful Ingredients

The following chemicals are known to damage the plastics on Zebra scanners and should not come in contact with the device:

- Acetone
- Ammonia solutions
- Aqueous or alcoholic alkaline solutions
- Aromatic and chlorinated hydrocarbons
- Benzene
- Carboic acid
- Compounds of amines or ammonia
- Ethanolamine
- Ethers
- Isopropyl alcohol 70% (including wipes)
- Ketones
- TB-lysoform
- Toluene
- Trichloroethylene.

### Approved Cleaners for the Digital Scanner and Cradle

- Hydrogen peroxide
- Mild dish soap.

### Cleaning the Digital Scanner

Routinely cleaning the exit window is required. A dirty window may affect scanning accuracy. Do not allow any abrasive material to touch the window.

To clean the digital scanner:

1. Dampen a soft cloth with one of the approved cleaning agents listed above or use pre-moistened wipes.
2. Gently wipe all surfaces, including the front, back, sides, top and bottom. Never apply liquid directly to the digital scanner. Be careful not to let liquid pool around the digital scanner window, trigger, cable connector or any other area on the device.
3. Be sure to clean the trigger and in between the trigger and the housing (use a cotton-tipped applicator to reach tight or inaccessible areas).
4. Do not spray water or other cleaning liquids directly into the exit window.
5. Wipe the digital scanner exit window with a lens tissue or other material suitable for cleaning optical material such as eyeglasses.
6. Immediately dry the digital scanner window after cleaning with a soft non-abrasive cloth to prevent streaking.
7. Allow the unit to air dry before use.
8. Digital scanner connectors:
  - a. Dip the cotton portion of a cotton-tipped applicator in an approved cleaner.
  - b. Rub the cotton portion of the cotton-tipped applicator back-and-forth across the connector on the Zebra digital scanner at least 3 times. Do not leave any cotton residue on the connector.
  - c. Use the cotton-tipped applicator dipped in alcohol to remove any grease and dirt near the connector area.
  - d. Use a dry cotton tipped applicator and rub the cotton portion of the cotton-tipped applicator back-and-forth across the connectors at least 3 times. Do not leave any cotton residue on the connectors.

## Troubleshooting

**Table 4-1** *Troubleshooting*

Problem	Possible Causes	Possible Solutions
The aiming pattern does not appear when pressing the trigger.	No power to the digital scanner.	If the configuration requires a power supply, re-connect the power supply.
	Incorrect host interface cable is used.	Connect the correct host interface cable.
	Interface/power cables are loose.	Re-connect cables.
	Digital scanner is disabled.	For IBM 468x and USB IBM Hand-held, IBM Table-Top, and OPOS modes, enable the digital scanner via the host interface. Otherwise, see the technical person in charge of scanning.
	If using RS-232 Nixdorf B mode, CTS is not asserted.	Assert CTS line.
	Aiming pattern is disabled.	Enable the aiming pattern. See <i>Hand-Held Decode Aiming Pattern</i> on page 5-18.
Digital scanner emits aiming pattern, but does not decode the bar code.	Digital scanner is not programmed for the correct bar code type.	Program the digital scanner to read that type of bar code. See <a href="#">Chapter 13, Symbologies</a> .
	Bar code symbol is unreadable.	Scan test symbols of the same bar code type to determine if the bar code is defaced.
	The symbol is not completely inside aiming pattern.	Move the symbol completely within the aiming pattern.  Move the symbol completely within the field of view (AIM pattern does NOT define FOV)
	Distance between digital scanner and bar code is incorrect.	Move the digital scanner closer to or further from the bar code. See <a href="#">Decode Ranges</a> on page 3-8.



**Table 4-1** *Troubleshooting (Continued)*

<b>Problem</b>	<b>Possible Causes</b>	<b>Possible Solutions</b>
Digital scanner decodes bar code, but does not transmit the data to the host.	Digital scanner is not programmed for the correct host type.	Scan the appropriate host type programming bar code. See the chapter corresponding to the host type.
	Interface cable is loose.	Re-connect the cable.
	Cradle is not programmed for the correct host type.	Check digital scanner host parameters or edit options.
	Digital scanner is not paired to host connected interface.	Pair digital scanner to the cradle by scanning the <b>PAIR</b> bar code on the cradle.
	Cradle has lost connection to the host.	In this exact order: disconnect power supply; disconnect host cable; wait three seconds; reconnect host cable; reconnect power supply; reestablish pairing.
	If the digital scanner emits four long low beeps, a transmission error occurred.  This occurs if a unit is not properly configured or connected to the wrong host type.	Set the digital scanner's communication parameters to match the host's setting.
	If the digital scanner emits five low beeps, a conversion or format error occurred.	Configure the digital scanner's conversion parameters properly.
If the digital scanner emits low/high/low beeps, it detected an invalid ADF rule.	Program the correct ADF rules. Refer to the <i>Advanced Data Formatting Programmer Guide</i> .	
Host displays scanned data incorrectly.	Digital scanner is not programmed to work with the host.	Scan the appropriate host type programming bar code.
		For RS-232, set the digital scanner's communication parameters to match the host's settings.
		For a Keyboard Wedge configuration, program the system for the correct keyboard type, and turn off the CAPS LOCK key.
		Program the proper editing options (e.g., UPC-E to UPC-A Conversion).
Digital scanner emits short low/short medium/short high beep sequence (power-up beep sequence) more than once.	The USB bus may put the digital scanner in a state where power to the digital scanner is cycled on and off more than once.	Normal during host reset.

**Table 4-1** Troubleshooting (Continued)

Problem	Possible Causes	Possible Solutions
Digital scanner emits four short high beeps during decode attempt.	Digital scanner has not completed USB initialization.	Wait several seconds and scan again.
Digital scanner emits Low/low/low/extra low beeps when not in use.	RS-232 receive error.	Normal during host reset. Otherwise, set the digital scanner's RS-232 parity to match the host setting.
Digital scanner emits low/high beeps during programming.	Input error, incorrect bar code or <b>Cancel</b> bar code was scanned.	Scan the correct numeric bar codes within range for the parameter programmed.
Digital scanner emits low/high/low/high beeps during programming.	Out of host parameter storage space.	Scan <i>Default Parameters on page 5-5</i> .
	Out of memory for ADF rules.	Reduce the number of ADF rules or the number of steps in the ADF rules.
	During programming, indicates out of ADF parameter storage space.	Erase all rules and re-program with shorter rules.
Digital scanner emits low/high/low beeps.	ADF transmit error.	Refer to the Advanced Data Formatting Guide for information.
	Invalid ADF rule is detected.	Refer to the Advanced Data Formatting Guide for information.
Digital scanner emits a power-up beep after changing USB host type.	The USB bus re-established power to the digital scanner.	Normal when changing USB host type.
Digital scanner emits one high beep when not in use.	In RS-232 mode, a <BEL> character was received and Beep on <BEL> option is enabled.	Normal when <b>Beep on &lt;BEL&gt;</b> is enabled and the digital scanner is in RS-232 mode.
Digital scanner emits frequent beeps.	No power to the digital scanner.	Check the system power. If the configuration requires a power supply, re-connect the power supply.
	Incorrect host interface cable is used.	Verify that the correct host interface cable is used. If not, connect the correct host interface cable.
	Interface/power cables are loose.	Check for loose cable connections and re-connect cables.

**Table 4-1** *Troubleshooting (Continued)*

<b>Problem</b>	<b>Possible Causes</b>	<b>Possible Solutions</b>
Digital scanner emits five long low beeps after a bar code is decoded.	Conversion or format error was detected. The digital scanner's conversion parameters are not properly configured.	Ensure the digital scanner's conversion parameters are properly configured.
	Conversion or format error was detected. An ADF rule was set up with characters that can't be sent for the host selected.	Change the ADF rule, or change to a host that can support the ADF rule.
	Conversion or format error was detected. A bar code was scanned with characters that can't be sent for that host.	Change the bar code, or change to a host that can support the bar code.
The digital scanner does not connect to the tablet/PC/phone using a Bluetooth Serial connection (SPP) or while emulating a Bluetooth keyboard (HID).	N/A	1. Turn off and then turn back on the Bluetooth radio on the tablet/PC/phone. A reboot of the tablet/PC/phone may be required.  or 2. Remove the device from the PC. Scan <i>Set Factory Defaults</i> on page 5-5 and reconfigure the digital scanner from scratch.
When trying to pair the digital scanner and cradle by scanning the pairing bar code on the CR2278, the digital scanner emits a rejection beep.	Pairing attempt occurs after scanning <b>Set Factory Defaults</b> .	After scanning <b>Set Factory Defaults</b> either insert the digital scanner in the cradle to pair or wait five seconds before scanning the pairing bar code on the cradle.
Digital scanner LED blinks even if the pairing request was canceled from remote iOS/Android device.	If pass key entry is canceled from the tablet/phone, the digital scanner remains in the pass key entry mode for 30 seconds before timing out.	To exit pass key entry mode scan <i>Cancel</i> on page H-1 or scan any other bar code.
There is a delay before illumination and aim turn on after a trigger pull.	N/A	Increase <i>Time Delay to Low Power Mode</i> on page 5-12 to help with radio wake up. <b>Note:</b> This could impact overall battery life.
There are firmware update failures (the firmware download does not go through).	N/A	Increase <i>Time Delay to Low Power Mode</i> on page 5-12 to help with radio wake up.



**NOTE** If after performing these checks the digital scanner still experiences problems, contact the distributor or call support.

## Report Software Version Bar Code

When contacting support, a support representative may ask you to scan the bar code below to determine the version of software installed in the digital scanner.



**Report Software Version**

## Technical Specifications

**Table 4-2** *Technical Specifications*

Item	Description
<b>Physical Characteristics</b>	
Dimensions	
Digital scanner	6.9 in. H x 2.6 in. W x 3.5 in. D 17.5 cm. H x 6.6 cm. W x 9.0 cm. D
Presentation Cradle	2.8 in. H x 3.7 in. W x 4.8 in. D 7.2 cm. H x 9.4 cm. W x 12.2 cm. D
Weight	
Digital scanner	7.5 oz. / 214 g
Presentation Cradle	5.2 oz. / 151 g
Input Voltage Range (DS2278 and Cradle)	4.5 to 5.5 VDC Host Powered; 4.5 to 5.5 VDC External Power Supply
Current (Presentation Cradle and Micro USB Cable)	500 mA (typical) Standard USB; 1100 mA (typical) BC 1.2 USB
Color	Nova White, Twilight Black
Supported Host Interfaces	USB, RS-232, Keyboard Wedge, TGCS (IBM) 46XX over RS-485
USB Certification	DS2278 is USB2.0 Full Speed Compliant, visit <a href="http://USB.org">USB.org</a> for more details.
Keyboard Support	Supports over 90 international keyboards
User Indicators	Direct Decode Indicator, Good Decode LEDs, Rear View LEDs, Beeper (adjustable tone and volume)
<b>Performance Characteristics</b>	
Motion Tolerance (Hand-Held)	Up to 5 in./13 cm. per second for 13 mil UPC
Swipe Speed (Hands-Free)	Up to 30.0 in./76.2 cm. per second for 13 mil UPC
Aiming Pattern	Linear 624nm Amber LED
Illumination	Two 645nm Super-Red LEDs
Imager Field of View	32.8° H x 24.8° V Nominal
Image Sensor	640 x 480 pixels
Minimum Print Contrast	25% minimum reflective difference
Skew Tolerance	+/- 65°
Pitch Tolerance	+/- 65°
Roll Tolerance	0° - 360°

**Table 4-2** *Technical Specifications (Continued)*

Item	Description	
<b>User Environment</b>		
Operating Temperature	Digital scanner	32.0° to 122.0° F/0.0° to 50.0° C
	Presentation Cradle	32.0° to 104.0° F/0.0° to 40.0° C
Storage Temperature		-40.0° to 158.0° F/-40.0° to 70.0° C
Humidity		5% to 95% RH, non-condensing
Drop Specification		Designed to withstand multiple drops at 5.0 ft./1.5 m to concrete
Tumble Specification		Designed to withstand 250 tumbles in 1.5 ft./1.5 m tumbler Note: 1 tumble = 0.5 cycle
Environmental Sealing		IP52
Electrostatic Discharge (ESD)		DS2278 and Presentation Cradle: ESD per EN61000-4-2, +/-15 KV Air, +/-8 KV Direct, +/-8 KV Indirect
Ambient Light Immunity		0 to 10,000 Foot Candles / 0 to 107,600 Lux
<b>Radio Specifications</b>		
Bluetooth Radio	<b>Standard Bluetooth Version 4.0 with BLE:</b> Direct line of sight in open air: Class 2: Minimum 30 ft. (10.0 m) and up to 300 ft. (100.0 m) when paired with CR2278 cradle. Environmental factors may impact results. Serial Port and HID Profiles; output power adjustable down from 2.0 dBm in 8 steps.	
<b>Battery</b>		
Battery Capacity/Battery Type	2,400 mAh Li-Ion Battery	
Scans Per Battery Charge	110,000 scans at 60 scans per minute or 50,000 scans at 10 scans per minute <b>Note:</b> Simulated Checkout profile of 10 scans in 10 seconds with a 50 second rest.	
Operating Time Per Full Charge	84.0 hours <b>Note:</b> Simulated Checkout profile of 10 scans in 10 seconds with a 50 second rest.	
Charge Time (from Empty)	14 Hour Shift Hours	Full Charge Hours
	Standard USB	4
	BC1.2 USB	1
	External 5V Source	1
	Micro USB	1.5
	BC1.2 Micro USB	1
		17
		5
		5
		7
		4

## 4 - 10 DS2278 Digital Scanner Product Reference Guide

**Table 4-2** *Technical Specifications (Continued)*

Item	Description
<b>Symbol Decode Capability</b>	
1D	Code 39, Code 128, Code 93, Codabar/NW7, Code 11, MSI Plessey, UPC/EAN, Interleaved 2 of 5, Korean 3 of 5, GS1 DataBar, Base 32 (Italian Pharma)
2D	PDF417, Composite Codes, TLC-39, Aztec, DataMatrix, MaxiCode, QR Code, Micro QR, Han Xin (Chinese Sensible), Postal Codes
<b>Minimum Element Resolution</b>	
Code 39	4.0 mil
Code 128	4.0 mil
Data Matrix	6.0 mil
QR Code	6.7 mil
<b>Utilities and Management</b>	
123Scan	Programs digital scanner parameters, upgrades firmware, provides scanned bar code data and prints reports (see <a href="#">Chapter 2, 123Scan and Software Tools</a> ).
Symbol Scanner SDK	Generates a fully-featured scanner application, including documentation, drivers, test utilities and sample source code ( <a href="http://www.zebra.com/ScannerSDKforWindows">www.zebra.com/ScannerSDKforWindows</a> )
Scanner Management Service (SMS)	Remotely manages your Zebra scanner and queries its asset information ( <a href="http://www.zebra.com/sms">www.zebra.com/sms</a> ).

## Cradle Signal Descriptions

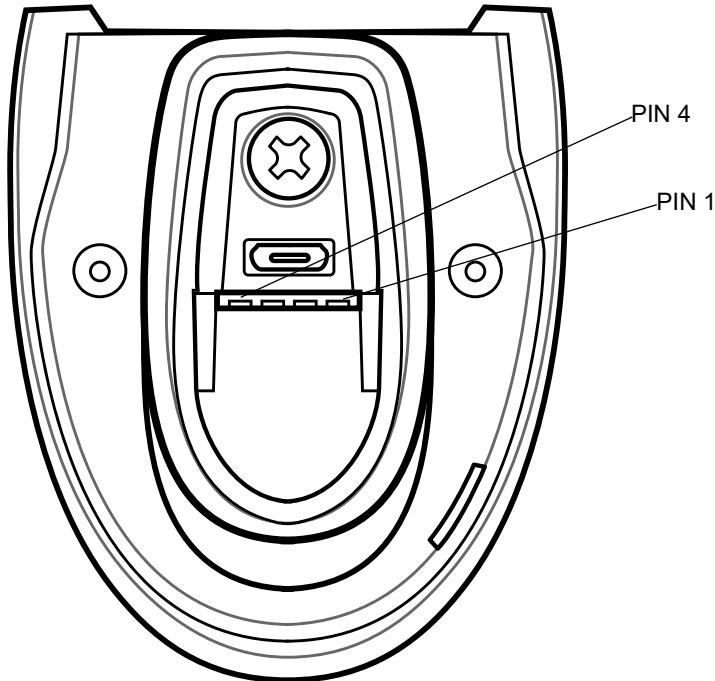

**Figure 4-1** Cradle Pinouts

The signal descriptions in [Table 4-3](#) apply to the contacts on the digital scanner and are for reference only.

**Table 4-3** Signal Pinouts

Pin	Function
1	5VDC
2	USB_D-
3	USB_D+
4	Ground

The signal descriptions in [Table 4-4](#) apply to the connectors on the DS2278 digital scanner and are for reference only.

**Table 4-4** DS2278 Digital Scanner Signal Pin-outs

Pin	USB	RS-232	Keyboard Wedge	IBM
1	Short to Pin 6	Reserved	1M Resistor to Pin 8	2M Resistor to Pin 8
2	Power	Power	Power	Power
3	Ground	Ground	Ground	Ground
4	Reserved	TXD	KBD_CLK	IBM_TXD
5	D +	RXD	TERM_DATA	IBM_RXD



## 4 - 12 DS2278 Digital Scanner Product Reference Guide

**Table 4-4** DS2278 Digital Scanner Signal Pin-outs (Continued)

Pin	USB	RS-232	Keyboard Wedge	IBM
<b>6</b>	Short to Pin 1	RTS	KBD_DATA	IBM_DIR
<b>7</b>	D -	CTS	TERM_CLK	Reserved
<b>8</b>	Reserved	Reserved	1M Resistor to Pin 1	2M Resistor to Pin 1
<b>9</b>	Reserved	Reserved	Reserved	Reserved
<b>10</b>	Reserved	Reserved	Reserved	Reserved
<b>SHELL</b>	Shield	Shield	Shield	Shield

# CHAPTER 5 USER PREFERENCES & MISCELLANEOUS OPTIONS

---

## Introduction

You can program the scanner to perform various functions, or activate different features. This chapter describes user preference features and provides programming bar codes for selecting these features.

The scanner ships with the settings shown in [Table 5-1 on page 5-2](#) (also see [Appendix A, Standard Default Parameters](#) for all defaults). If the default values suit requirements, programming is not necessary.

---

## Setting Parameters

To set feature values, scan a single bar code or a short bar code sequence. The settings are stored in non-volatile memory and are preserved even when the scanner powers down.

- ✓ **NOTE** Most computer monitors allow scanning bar codes directly on the screen. When scanning from the screen, be sure to set the document magnification to a level where you can see the bar code clearly, and bars and/or spaces do not merge.

If not using the default host, select the host type (see each host chapter for specific host information) after the power-up beeps sound. This is only necessary upon the first power-up when connected to a new host.

To return all features to default values, see [Default Parameters on page 5-5](#). Throughout the programming bar code menus, asterisks indicate (\*) default values.



\* Indicates default — \*Enable Parameter — Feature/option  
(1) — Option value

## Scanning Sequence Examples

In most cases, scanning one bar code sets the parameter value. For example, to set the beeper tone to high, scan the **High Frequency** (beeper tone) bar code listed under [Beeper Tone on page 5-8](#). The scanner issues a fast warble beep and the LED turns green, signifying a successful parameter entry.

Other parameters, such as **Serial Response Timeout** or **Data Transmission Formats**, require scanning several bar codes. See the parameter descriptions for this procedure.

## Errors While Scanning

Unless otherwise specified, to correct an error during a scanning sequence, just re-scan the correct parameter.

## User Preferences/Miscellaneous Options Parameter Defaults

[Table 5-1](#) lists defaults for user preferences parameters. Change these values in one of two ways:

- Scan the appropriate bar codes in this chapter. The new value replaces the standard default value in memory. To recall default parameter values, see [Default Parameters on page 5-5](#).
- Configure the scanner using the 123Scan configuration program. See [Chapter 2, 123Scan and Software Tools](#).

✓ **NOTE** See [Appendix A, Standard Default Parameters](#) for all user preference, host, symbology, and miscellaneous default parameters.

**Table 5-1** *User Preferences Parameter Defaults*

Parameter	Parameter Number <sup>1</sup>	SSI Number <sup>2</sup>	Default	Page Number
<b>User Preferences</b>				
Set Default Parameter	N/A	N/A	N/A	<a href="#">5-5</a>
Parameter Bar Code Scanning	236	ECh	Enable	<a href="#">5-6</a>
Beep After Good Decode	56	38h	Enable	<a href="#">5-6</a>
Beeper Volume	140	8Ch	High	<a href="#">5-7</a>
Beeper Tone	145	91h	Medium	<a href="#">5-8</a>
Beeper Duration	628	F1h 74h	Medium	<a href="#">5-9</a>
Suppress Power Up Beeps	721	F1h D1h	Do Not Suppress	<a href="#">5-9</a>
LED on Good Decode	744	F1h E8h	Enable	<a href="#">5-10</a>
Direct Decode Indicator	859	F2h 5Bh	Disable	<a href="#">5-10</a>
Low Power Mode	128	80h	Enable	<a href="#">5-11</a>
Time Delay to Low Power Mode	146	92h	100 msec	<a href="#">5-12</a>

1. Parameter number decimal values are used for programming via RSM commands.
2. SSI number hex values are used for programming via SSI commands.

**Table 5-1** *User Preferences Parameter Defaults (Continued)*

Parameter	Parameter Number <sup>1</sup>	SSI Number <sup>2</sup>	Default	Page Number
Timeout to Low Power Mode from Auto Aim	729	F1h D9h	15 sec	<a href="#">5-14</a>
Battery Preservation Mode	1765	F8h 06h E5h	Enable	<a href="#">5-15</a>
Trigger Mode (or Hand-Held Trigger Mode)	138	8Ah	Standard (Level)	<a href="#">5-16</a>
Hands-Free Mode	630	F1h 76h	Enable	<a href="#">5-17</a>
Hand-Held Decode Aiming Pattern	306	F0h 32h	Enable	<a href="#">5-18</a>
Hands-Free (Presentation) Decode Aiming Pattern	590	F1h 4Eh	Enable Hands-Free (Presentation) Decode Aiming Pattern on PDF	<a href="#">5-19</a>
Picklist Mode	402	F0h 92h	Disable Picklist Mode Always	<a href="#">5-20</a>
Continuous Bar Code Read	649	F1h 89h	Disable	<a href="#">5-21</a>
Unique Bar Code Reporting	723	F1h D3h	Enable	<a href="#">5-21</a>
Decode Session Timeout	136	88h	9.9 Seconds	<a href="#">5-22</a>
Hands-Free Decode Session Timeout	400	F0 90	15	<a href="#">5-22</a>
Timeout Between Decodes, Same Symbol	137	89h	0.5 Seconds	<a href="#">5-23</a>
Timeout Between Decodes, Different Symbols	144	90h	0.1 Seconds	<a href="#">5-23</a>
Decode Mirror Images (Data Matrix Only)	537	F1h 19h	Auto	<a href="#">5-24</a>
Mobile Phone/Display Mode	N/A	N/A	N/A	<a href="#">5-24</a>
PDF Prioritization	719	F1h CFh	Disable	<a href="#">5-25</a>
PDF Prioritization Timeout	720	F1h D0h	200 ms	<a href="#">5-25</a>
Decoding Illumination	298	F0h 2Ah	Enable	<a href="#">5-26</a>
Illumination Brightness	669	F1h 9Dh	High	<a href="#">5-26</a>
Low Light Scene Detection	810	F2h 2Ah	Dim Illumination Low Light Assist Scene Detection	<a href="#">5-27</a>
Motion Tolerance (Hand-Held Trigger Mode Only)	858	F2h 5Ah	Less	<a href="#">5-28</a>
Product ID (PID) Type	1281	F8h 05h 01h	Host Type Unique	<a href="#">5-29</a>
Product ID (PID) Value	1725	F8h 06h BDh	0	<a href="#">5-29</a>
ECLevel	1710	F8h 06h AEh	0	<a href="#">5-30</a>

**1. Parameter number decimal values are used for programming via RSM commands.  
2. SSI number hex values are used for programming via SSI commands.**

**Table 5-1** *User Preferences Parameter Defaults (Continued)*

Parameter	Parameter Number <sup>1</sup>	SSI Number <sup>2</sup>	Default	Page Number
<b>Miscellaneous Options</b>				
Enter Key	N/A	N/A	N/A	<a href="#">5-31</a>
Tab Key	N/A	N/A	N/A	<a href="#">5-31</a>
Transmit Code ID Character	45	2Dh	None	<a href="#">5-32</a>
Prefix Value	99, 105	63h, 69h	7013 <CR><LF>	<a href="#">5-33</a>
Suffix 1 Value Suffix 2 Value	98, 104 100, 106	62h, 68h 64h, 6Ah	7013 <CR><LF>	<a href="#">5-33</a>
Scan Data Transmission Format	235	EBh	Data As Is	<a href="#">5-34</a>
FN1 Substitution Values	103, 109	67h, 6Dh	7013 <CR><LF>	<a href="#">5-36</a>
Transmit "No Read" Message	94	5E	Disable	<a href="#">5-37</a>
Unsolicited Heartbeat Interval	1118	F8h 04h 5Eh	Disable	<a href="#">5-38</a>
<b>Send Versions</b>				
Software Version	N/A	N/A	N/A	<a href="#">5-39</a>
Serial Number	N/A	N/A	N/A	<a href="#">5-39</a>
Manufacturing Information	N/A	N/A	N/A	<a href="#">5-39</a>

1. Parameter number decimal values are used for programming via RSM commands.
2. SSI number hex values are used for programming via SSI commands.

---

## User Preferences

### Default Parameters

- ✓ **NOTE** To pair the scanner and cradle after scanning **Set Factory Defaults** either insert the scanner in the cradle to pair or wait five seconds before scanning the pairing bar code on the cradle.

Scan one of the following bar codes to reset the scanner to its default settings as follows:

- **Restore Defaults** resets all default parameters as follows:
  - If you configured custom default parameter values via the **Write to Custom Defaults** bar code, scanning the **Restore Defaults** bar code restores these custom values.
  - If you did not configure custom default parameter values, scanning the **Restore Defaults** bar code restores the factory default values. See [Appendix A, Standard Default Parameters](#) for these values.
- **Set Factory Defaults** clears all custom default values and sets the factory default values. See [Appendix A, Standard Default Parameters](#) for these values.

### Write to Custom Defaults

To create a set of custom defaults, select the desired parameter values in this guide, and then scan **Write to Custom Defaults**.

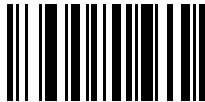

**Restore Defaults**



**Set Factory Defaults**



**Write to Custom Defaults**

## Parameter Bar Code Scanning

Parameter # 236

SSI # ECh

Scan one of the following bar codes to select whether to enable or disable the decoding of parameter bar codes, including the **Set Defaults** bar codes.



**\*Enable Parameter Bar Code Scanning**  
(1)



**Disable Parameter Bar Code Scanning**  
(0)

## Beep After Good Decode

Parameter # 56

SSI # 38h

Scan one of the following bar codes to select whether or not the scanner beeps after a good decode. If you select **Disable Beep After Good Decode**, the beeper still operates during parameter menu scanning and to indicate error conditions.



**\*Enable Beep After Good Decode**  
(1)



**Disable Beep After Good Decode**  
(0)

## Beeper Volume

Parameter # 140

SSI # 8Ch

Scan one of the following bar codes to select a beeper volume.



**Low Volume**  
(2)



**Medium Volume**  
(1)



**\*High Volume**  
(0)



## Beeper Tone

Parameter # 145

SSI # 91h

Scan one of the following bar codes to select a beeper tone for the good decode beep.

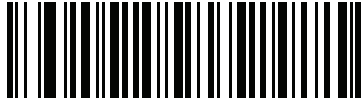

**Disable Tone**  
**(3)**



**Low Tone**  
**(2)**

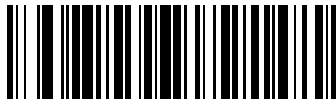

**\*Medium Tone**  
**(1)**



**High Tone**  
**(0)**



**Medium to High Tone (2-tone)**  
**(4)**

## Beeper Duration

Parameter # 628

SSI # F1h 74h

Scan one of the following bar codes to select the duration for the good decode beep.

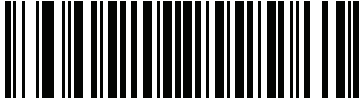

Short Duration  
(0)



\*Medium Duration  
(1)

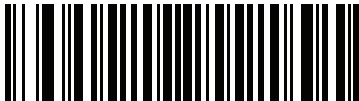

Long Duration  
(2)

## Suppress Power Up Beeps

Parameter # 721

SSI # F1h D1h

Scan one of the following bar codes to select whether or not to suppress the scanner's power-up beeps.



\*Do Not Suppress Power Up Beeps  
(0)



Suppress Power Up Beeps  
(1)

## LED on Good Decode

Parameter # 744

SSI # F1h E8h

Scan one of the following bar codes to select whether or not the LED blinks on a good decode.



\*Enable LED on Good Decode  
(2)



Disable LED on Good Decode  
(0)

## Direct Decode Indicator

Parameter # 859

SSI # F2h 5Bh

This parameter is only supported in Auto Aim and Standard (Level) *Trigger Mode*. Scan one of the following bar codes to select optional blinking of the illumination on a successful decode. You must continue to hold the trigger upon decode to see the illumination blink. If you release the trigger upon decode, the blinking does not occur. If you release the trigger upon decode, the blinking does not occur. This allows you to choose additional feedback for a successful decode by holding the trigger, or to continue to scan as normal.

- **\*Disable Direct Decode Indicator** - Illumination does not blink on a successful decode.
- **1 Blink** - Illumination blinks once upon a successful decode.
- **2 Blinks** - Illumination blinks twice upon a successful decode.



\*Disable Direct Decode Indicator  
(0)



1 Blink  
(1)



2 Blinks  
(2)

## Low Power Mode

Parameter # 128

SSI # 80h

✓ **NOTE** The Low Power Mode parameter only applies for non-USB and non-RS485 host interfaces, and when [Trigger Mode on page 5-16](#) is set to **Level (Standard)**.

Scan one of the following bar codes to select whether or not the scanner enters low power mode after a decode attempt or host communication. This applies to serial and keyboard wedge connections. If disabled, power remains on after each decode attempt.

If you enable this, see [Time Delay to Low Power Mode](#) to set the inactivity time period.



**\*Enable Low Power Mode  
(1)**



**Disable Low Power Mode  
(0)**

## Time Delay to Low Power Mode

Parameter # 146

SSI # 92h

✓ **NOTE** This parameter only applies when Low Power Mode is enabled.

This parameter sets the time the digital scanner remains active before entering low power mode. The digital scanner wakes upon trigger pull or when the host attempts to communicate with the digital scanner.



\*100 msec  
(65)



500 msec  
(69)

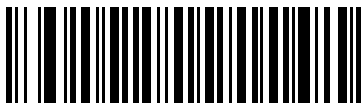

1 Second  
(17)



2 sec  
(18)



3 sec  
(19)



4 sec  
(20)

**Time Delay to Low Power Mode (continued)**



**5 sec  
(21)**



**10 sec  
(26)**



**15 sec  
(27)**

## Timeout to Low Power Mode from Auto Aim

Parameter # 729

SSI # F1 D9

This parameter sets the time the scanner remains in auto aim before entering Low Power Mode.

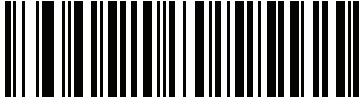

Disabled  
(0)

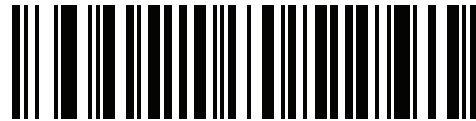

5 sec  
(5)



\* 15 sec  
(11)



30 sec  
(13)



1 minute  
(17)

## Battery Preservation Mode

Parameter # 1765

SSI # F8h 06h E5h

Battery Preservation Mode preserves the battery charge when the digital scanner is not being used for an extended period of time.

- Scan **Enable Battery Preservation Mode** to internally disconnect the battery from the digital scanner when the digital scanner is unused and not being charged for nine hours<sup>1</sup>. In this mode the scanner completely turns off. This preserves the battery charge as there is no current drain on the battery and significantly extends battery shelf life. To exit Battery Preservation Mode<sup>2</sup> and return to normal operation either press the digital scanner trigger or return to charging. The digital scanner cannot scan until the wake up process is complete<sup>3</sup>. This takes a few seconds. The amount of time before the battery disconnects from the scanner can be set via **Battery Preservation Timeout Value** below.

- ✓ **NOTES**
- <sup>1</sup> Nine hours is the default timeout value but can be changed via Battery Preservation Timeout Value.
  - <sup>2</sup> Low Power Mode ([5-11](#)) must be enabled for Battery Preservation Mode to take effect.
  - <sup>3</sup> When asleep in Battery Preservation Mode, the digital scanner cannot be accessed for remote management.

- Scan **Disable Battery Preservation Mode** to keep the battery connected to the digital scanner at all times. This prevents the battery from being disconnected from the scanner after hours of sitting idle (no scanning) and not charging. When Battery Preservation Mode is disabled, substantial battery shelf life improvements are not gained as compared to when Battery Preservation Mode is enabled.
- Scan **Battery Preservation Timeout** followed by 3 digits in [Appendix G, Numeric Bar Codes](#) to select a different battery preservation timeout value (the default for battery preservation timeout is nine hours). For example, if the preservation timeout value should be 12 hours, scan **Battery Preservation Timeout** below, then scan **0**, **1**, and **2** in [Appendix G, Numeric Bar Codes](#). To correct an error or change the selection, scan *Cancel on page G-3*.



\*Enable Battery Preservation Mode  
(9)



Disable Battery Preservation Mode  
(0)



Battery Preservation Timeout Value



## Trigger Mode

Parameter # 138

SSI # 8Ah

Scan one of the following bar codes to select a trigger mode for the scanner:

- **Standard (Level)** - A trigger press activates decode processing. Decode processing continues until the bar code decodes, you release the trigger, or the *Decode Session Timeout on page 5-22* occurs.
- **Presentation (Blink)** - The scanner activates decode processing when it detects a bar code in its field of view. After a period of non-use, the scanner illumination and aimer settings change due to the default *Low Light Scene Detection* setting. The scanner re-activates decode processing when the scanner senses motion.
- **Auto Aim** - The scanner projects the aiming pattern when lifted. A trigger press activates decode processing. After two seconds of inactivity the aiming pattern shuts off.

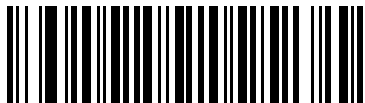

**\*Standard (Level)**  
(0)



**Presentation (Blink)**  
(7)

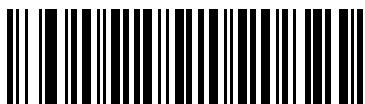

**Auto Aim**  
(9)

## Hands-Free Mode

Parameter # 630

SSI # F1h 76h

Scan one of the following bar codes to enable or disable hands-free mode:

- **Enable Hands-Free Mode** - When you place the scanner in a stand, it automatically triggers when presented with a bar code. Lifting the scanner or pulling the trigger causes it to behave according to the setting of the [Trigger Mode on page 5-16](#).
- **Disable Hands-Free Mode** - The scanner behaves according to the setting of the [Trigger Mode on page 5-16](#) regardless of whether it is hand-held or in stand.



**\*Enable Hands-Free Mode  
(1)**

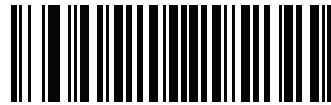

**Disable Hands-Free Mode  
(0)**

## Hand-Held Decode Aiming Pattern

Parameter # 306

SSI # F0h 32h

Scan one of the following bar codes to select when to project the aiming pattern in hand-held mode:

- **Enable Hand-Held Decode Aiming Pattern** - This projects the aiming pattern during bar code capture.
- **Disable Hand-Held Decode Aiming Pattern** - This turns the aiming pattern off.
- **Enable Hand-Held Decode Aiming Pattern on PDF** - This projects the aiming pattern when the scanner detects a PDF bar code.

✓ **NOTE** With [Picklist Mode on page 5-20](#) enabled, the decode aiming pattern flashes even if you disable the **Hand-Held Decode Aiming Pattern**.

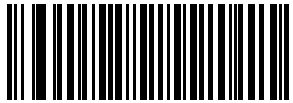

**\*Enable Hand-Held Decode Aiming Pattern**  
(2)

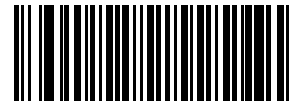

**Disable Hand-Held Decode Aiming Pattern**  
(0)

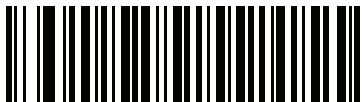

**Enable Hand-Held Decode Aiming Pattern on PDF**  
(3)

## Hands-Free (Presentation) Decode Aiming Pattern

Parameter # 590

SSI # F1h 4Eh

Scan one of the following bar codes to select when to project the aiming pattern in hands-free mode:

- **Enable Hands-Free (Presentation) Decode Aiming Pattern** - This projects the aiming pattern during bar code capture.
- **Disable Hands-Free (Presentation) Decode Aiming Pattern** - This turns the aiming pattern off.
- **Enable Hands-Free (Presentation) Decode Aiming Pattern on PDF** - This projects the aiming pattern when the scanner detects a PDF bar code.

✓ **NOTE** With [Picklist Mode on page 5-20](#) enabled, the decode aiming pattern flashes even when you disable the Hands-Free Decode Aiming Pattern.



**Enable Hands-Free (Presentation)  
Decode Aiming Pattern  
(1)**



**Disable Hands-Free (Presentation)  
Decode Aiming Pattern  
(0)**



**\*Enable Hands-Free (Presentation)  
Decode Aiming Pattern on PDF  
(2)**

## Picklist Mode

### Parameter # 402

### SSI # F0h 92h

Scan one of the following bar codes to select a Picklist Mode. In this mode, you can pick out and decode a bar code from a group of bar codes that are printed close together by placing the aiming pattern on the bar code you want to decode.

✓ **NOTE** Enabling Picklist Mode overrides the Disable Decode Aiming Pattern options. You can not disable the decode aiming pattern when Picklist Mode is enabled.

Enabling Picklist Mode can slow decode speed and hinder the ability to decode longer bar codes.

- **Enable Picklist Mode Always** - Picklist Mode is always enabled.
- **Enable Picklist Mode in Hand-Held Mode** - Picklist Mode is enabled when the scanner is out of hands-free mode and disabled when the scanner is in presentation mode.
- **Enable Picklist Mode in Hands-Free Mode** - Picklist Mode is enabled when the scanner is in hands-free mode only.
- **Disable Picklist Mode Always** - Picklist Mode is always disabled.

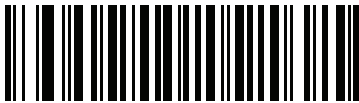

**Enable Picklist Mode Always**  
(2)



**Enable Picklist Mode in Hand-Held Mode**  
(1)

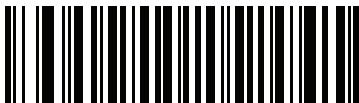

**Enable Picklist Mode in Hands-Free Mode**  
(3)



**\*Disable Picklist Mode Always**  
(0)

## Continuous Bar Code Read

Parameter # 649

SSI # F1h 89h

Scan **Enable Continuous Bar Code Read** to report every bar code while the trigger is pressed.



**NOTE** We strongly recommend enabling [Picklist Mode on page 5-20](#) with this parameter. Disabling Picklist Mode can cause accidental decodes when more than one bar code is in the scanner's field of view.



**Enable Continuous Bar Code Read**  
(1)

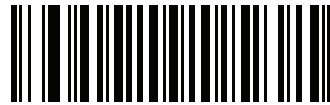

**\*Disable Continuous Bar Code Read**  
(0)

## Unique Bar Code Reporting

Parameter # 723

SSI # F1h D3h

Scan **Enable Continuous Bar Code Read Uniqueness** to report only unique bar codes while the trigger is pressed. This option only applies when [Continuous Bar Code Read](#) is enabled.



**\*Enable Unique Bar Code Reporting**  
(1)



**Disable Unique Bar Code Reporting**  
(0)

## Decode Session Timeout

**Parameter # 136**

**SSI # 88h**

This parameter sets the maximum time decode processing continues during a scan attempt. It is programmable in 0.1 second increments from 0.5 to 9.9 seconds. The default timeout is 9.9 seconds.

To set a Decode Session Timeout, scan the following bar code, and then scan two bar codes from [Appendix G, Numeric Bar Codes](#) that correspond to the desired on time. Enter a leading zero for single digit numbers. For example, to set a Decode Session Timeout of 0.5 seconds, scan this bar code, and then scan the **0** and **5** bar codes. To correct an error or change the selection, scan *Cancel on page G-3*.



**Decode Session Timeout**

## Hands-Free Decode Session Timeout

**Parameter # 400**

**SSI # F0 90**

This parameter is the hands-free compliment to the Decode Session Timeout. It configures the minimum and maximum decode processing time during a hands-free scan attempt. It only applies to the hands-free trigger mode or when a scanner is place in the gooseneck stand. The default is 15; range = 2 - 255.

The minimum decode processing time is defined as the time in which the scanner stops decoding when an object is removed or left stationary in the imaging field of view.

The maximum decode processing time is defined as the time in which the scanner stops decoding when an object is left in or is moving in the field of view.

Both the maximum and minimum times are configured using a single setting. The relationship of this setting is as follows:

Setting Value <sup>1</sup>	Minimum Time	Maximum Time
X < 25	250 ms	2.5 Seconds
X >= 25	X * 10 ms	X * 100 ms

<sup>1</sup>Setting value must be three digits.

For example, a setting value of 100 results in the scanner turning off approximately 1 second after an object is removed from the field of view or 10 seconds while an object is in the field of view moving.

The default value of the setting is 15 which results in a minimum time of 250 ms and maximum time of 2.5 seconds.

Adjust this setting based on your requirements. For example, when doing PDF prioritization, this parameter should be set to a value where the maximum time is above the PDF prioritization timeout.

To set a three digit value scan the following bar code, and then scan three bar codes from [Appendix G, Numeric Bar Codes](#). Enter a leading zero for single digit numbers. To correct an error or change a selection, scan *Cancel on page G-3*.

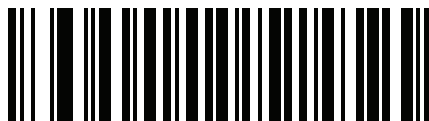

**Hands-Free Decode Session Timeout**

## Timeout Between Decodes, Same Symbol

**Parameter # 137**

**SSI # 89h**

Use this option in presentation mode or *Continuous Bar Code Read* mode to prevent the scanner from continuously decoding the same bar code when it is left in the scanner's field of view. The bar code must be out of the field of view for the timeout period before the scanner reads the same consecutive symbol. It is programmable in 0.1 second increments from 0.0 to 9.9 seconds. The default interval is 0.5 seconds.

To select the timeout between decodes for the same symbol, scan the following bar code, and then scan two bar codes from [Appendix G, Numeric Bar Codes](#) that correspond to the desired interval, in 0.1 second increments.



**Timeout Between Decodes, Same Symbol**

## Timeout Between Decodes, Different Symbols

**Parameter # 144**

**SSI # 90h**

Use this option in presentation mode or *Continuous Bar Code Read* to control the time the scanner waits before decoding a different symbol. It is programmable in 0.1 second increments from 0.1 to 9.9 seconds. The default is 0.1 seconds.

To select the timeout between decodes for different symbols, scan the following bar code, and then scan two bar codes from [Appendix G, Numeric Bar Codes](#) that correspond to the desired interval, in 0.1 second increments..

- ✓ **NOTE** Timeout Between Decodes, Different Symbols cannot be greater than or equal to the *Decode Session Timeout*.



**Timeout Between Decodes, Different Symbols**



## Decode Mirror Images (Data Matrix Only)

Parameter # 537

SSI # F1h 19h

Select an option for decoding mirror image Data Matrix bar codes:

- Always - decode only Data Matrix bar codes that are mirror images
- Never - do not decode Data Matrix bar codes that are mirror images
- Auto - decode both mirrored and unmirrored Data Matrix bar codes.

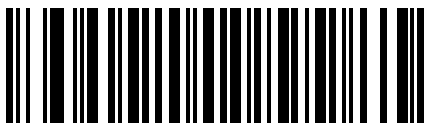

**Never**  
(0)

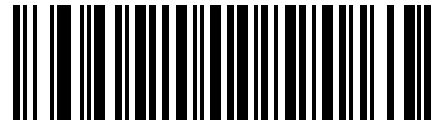

**Always**  
(1)

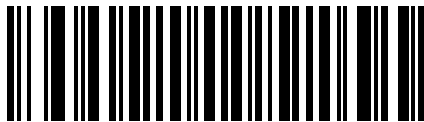

**\*Auto**  
(2)

## Mobile Phone/Display Mode



**NOTE** Reading bar codes on mobile phones does not require a special mode of operation.

## PDF Prioritization

### Parameter # 719

#### SSI # F1h CFh

Scan **Enable PDF Prioritization** to delay decoding certain 1D bar codes (see *Note* below) by the value specified in [PDF Prioritization Timeout](#). During that time the scanner attempts to decode a PDF417 symbol (e.g., on a US driver's license), and if successful, reports this only. If it does not decode (can not find) a PDF417 symbol, it reports the 1D symbol after the timeout. The 1D symbol must be in the device's field of view for the scanner to report it. This parameter does not affect decoding other symbologies.



#### NOTE

The 1D Code 128 bar code lengths include the following:

- 7 to 10 characters
- 14 to 22 characters
- 27 to 28 characters

In addition, a Code 39 bar code with the following lengths are considered to potentially be part of a US driver's license:

- 8 characters
- 12 characters



**Enable PDF Prioritization  
(1)**



**\*Disable PDF Prioritization  
(0)**

## PDF Prioritization Timeout

### Parameter # 720

#### SSI # F1h D0h

If you enabled [PDF Prioritization](#), set this timeout to indicate how long the scanner attempts to decode a PDF417 symbol before reporting the 1D bar code in the field of view.

Scan the following bar code, and then scan four bar codes from [Appendix G, Numeric Bar Codes](#) that specify the timeout in milliseconds. For example, to enter 400 ms, scan the following bar code, and then scan 0400. The range is 0 to 5000 ms, and the default is 200 ms.

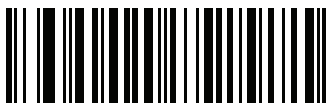

**PDF Prioritization Timeout**

## Decoding Illumination

**Parameter # 298**

**SSI # F0h 2Ah**

Scan one of the following bar codes to determine whether the scanner turns on illumination to aid decoding. Enabling illumination usually results in superior images and better decode performance. The effectiveness of the illumination decreases as the distance to the target increases.



**\*Enable Decoding Illumination  
(1)**



**Disable Decoding Illumination  
(0)**

## Illumination Brightness

**Parameter # 669**

**SSI # F1h 9Dh**

Scan one of the following bar codes to set the illumination brightness used during an active decode session. This only applies in hand-held mode (not in presentation mode).

✓ **NOTE** Selecting a lower brightness level can affect decode performance.



**Low Illumination Brightness  
(2)**



**Medium Illumination Brightness  
(4)**



**\*High Illumination Brightness  
(8)**

## Low Light Scene Detection

Parameter # 810

SSI # F2h 2Ah

Scan one of the following bar codes to allow the scanner to detect motion in dim to dark illumination environments when in presentation mode:

- **No Low Light Scene Detection** - The scanner attempts to detect motion as best it can with the aim pattern and illumination turned off when the scanner is idle.
- **Aiming Pattern Low Light Assist Scene Detection** - Illumination is off, but the aim pattern is on when the scanner is idle to assist in scene detection.
- **Dim Illumination Low Light Assist Scene Detection** - The aim pattern is off, but illumination is on at a dim level to assist in scene detection.



**No Low Light Assist Scene Detection**  
(0)



**Aiming Pattern Low Light Assist Scene Detection**  
(1)



**\*Dim Illumination Low Light Assist Scene Detection**  
(2)

## Motion Tolerance (Hand-Held Trigger Modes Only)

Parameter # 858

SSI # F2h 5Ah

Scan one of the following bar codes to select a motion tolerance option:

- **Less Motion Tolerance** - This provides optimal decoding performance on 1D bar codes.
- **More Motion Tolerance** - This increases motion tolerance and speeds decoding when scanning a series of 1D bar codes in rapid progression.



**\*Less Motion Tolerance  
(0)**

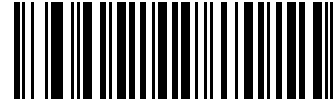

**More Motion Tolerance  
(1)**

## Product ID (PID) Type

Parameter # 1281

SSI # F8h 05h 01h

Scan one of the following bar codes to define the PID value reported in USB enumeration.

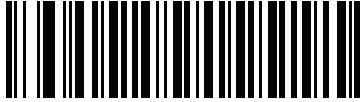

\*Host Type Unique  
(0)

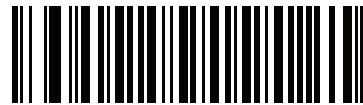

Product Unique  
(1)

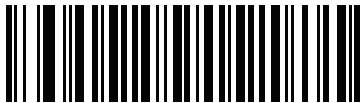

IBM Unique  
(2)

## Product ID (PID) Value

Parameter # 1725

SSI # F8h 06h BDh

To set a Product ID value, scan **Set PID Value**, and then scan four numeric bar codes in [Appendix G, Numeric Bar Codes](#) that correspond to the value. Enter a leading zero for single digit numbers. To correct an error, or change a selection, scan *Cancel on page G-3*. The range is (0,1600-1649).



**NOTE** This parameter is applicable to customers using a Firmware Flash Update per the Toshiba Global Commerce Solutions (TGCS) Universal Serial Bus OEM Point-of-Sale Device Interface.



Set PID Value

## ECLevel

**Parameter # 1710**

**SSI # F8h 06h AEh**

To set an ECLevel value, scan **Set ECLevel**, and then scan five numeric bar codes in [Appendix G, Numeric Bar Codes](#) that correspond to the desired level. Enter a leading zero for single digit numbers. To correct an error, or change a selection, scan *Cancel on page G-3*.

- ✓ **NOTE** This parameter is applicable to customers using a Firmware Flash Update per the Toshiba Global Commerce Solutions (TGCS) Universal Serial Bus OEM Point-of-Sale Device Interface. It allows a customer to define an ECLevel value in order to manage and control Flash Update operations on the 4690 operating system.

Contact the Zebra Customer Support Center online at: [www.zebra.com/support](http://www.zebra.com/support) for more information.



**Set ECLevel**

---

## Miscellaneous Scanner Parameters

### Enter Key

Scan the following bar code to add an Enter key (carriage return/line feed) after scanned data. To program other prefixes and/or suffixes, see [Prefix/Suffix Values on page 5-33](#).

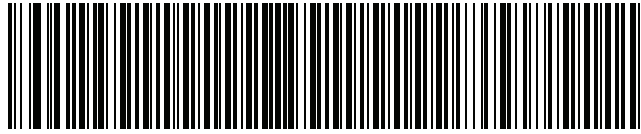

**Add Enter Key (Carriage Return/Line Feed)**

### Tab Key

Scan the following bar code to add a Tab key after scanned data.

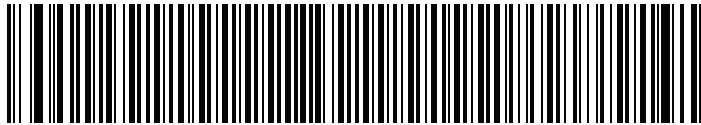

**Tab Key**



## Transmit Code ID Character

### Parameter # 45

#### SSI # 2Dh

A Code ID character identifies the code type of a scanned bar code. This is useful when decoding more than one code type. In addition to any single character prefix selected, the Code ID character is inserted between the prefix and the decoded symbol.

Select no Code ID character, a Symbol Code ID character, or an AIM Code ID character. For Code ID characters, see *Symbol Code Identifiers on page E-1* and *AIM Code Identifiers on page E-3*.

✓ **NOTE** If you enable Symbol Code ID Character or AIM Code ID Character, and enable *Transmit "No Read" Message on page 5-37*, the scanner appends the code ID for Code 39 to the NR message.



Symbol Code ID Character  
(2)



AIM Code ID Character  
(1)



\*None  
(0)

## Prefix/Suffix Values

**Key Category Parameter # P = 99, S1 = 98, S2 = 100**

**SSI # P = 63h, S1 = 62h, S2 = 64h**

**Decimal Value Parameter # P = 105, S1 = 104, S2 = 106**

**SSI # P = 69h, S1 = 68h, S2 = 6Ah**

You can append a prefix and/or one or two suffixes to scan data for use in data editing. To set a value for a prefix or suffix, scan one of the following bar codes, and then scan four bar codes from [Appendix G, Numeric Bar Codes](#) that correspond to that value. See [Appendix I, ASCII Character Sets](#) for the four-digit codes.

When using host commands to set the prefix or suffix, set the key category parameter to 1, and then set the 3-digit decimal value. See [Appendix I, ASCII Character Sets](#) for the four-digit codes.

The default prefix and suffix value is 7013 <CR><LF> (Enter key). To correct an error or change a selection, scan *Cancel on page G-3*.

✓ **NOTE** To use Prefix/Suffix values, first set the [Scan Data Transmission Format on page 5-34](#).

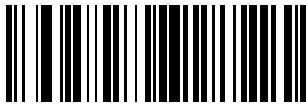

**Scan Prefix  
(7)**

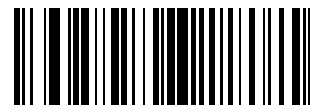

**Scan Suffix 1  
(6)**



**Scan Suffix 2  
(8)**



**Data Format Cancel**

## Scan Data Transmission Format

Parameter # 235

SSI # EBh

To change the scan data format, scan one of the following bar codes corresponding to the desired format.

✓ **NOTE** If using this parameter do not use ADF rules to set the prefix/suffix.

To set values for the prefix and/or suffix, see [Prefix/Suffix Values on page 5-33](#).



**\*Data As Is**  
(0)



**<DATA> <SUFFIX 1>**  
(1)



**<DATA> <SUFFIX 2>**  
(2)



**<DATA> <SUFFIX 1> <SUFFIX 2>**  
(3)

## Scan Data Transmission Format (continued)



<PREFIX> <DATA >  
(4)



<PREFIX> <DATA> <SUFFIX 1>  
(5)



<PREFIX> <DATA> <SUFFIX 2>  
(6)



<PREFIX> <DATA> <SUFFIX 1> <SUFFIX 2>  
(7)

## FN1 Substitution Values

**Key Category Parameter # 103**

**Key Category SSI # 67h**

**Decimal Value Parameter # 109**

**Decimal Value SSI # 6Dh**

Keyboard wedge and USB HID keyboard hosts support a FN1 substitution feature. Enabling this substitutes any FN1 character (0x1b) in an EAN128 bar code with a value. This value defaults to 7013 <CR><LF> (Enter key).

When using host commands to set the FN1 substitution value, set the key category parameter to 1, and then set the 3-digit keystroke value. See the ASCII Character Set table for the current host interface for the desired value.

To select a FN1 substitution value via bar code menus:

1. Scan the following bar code.

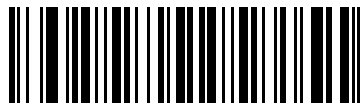

**Set FN1 Substitution Value**

2. Locate the keystroke desired for FN1 Substitution in the ASCII Character Set table for the current host interface, and enter the 4-digit ASCII value by scanning four bar codes from [Appendix G, Numeric Bar Codes](#).

To correct an error or change the selection, scan **Cancel**.

To enable FN1 substitution for USB HID keyboard, scan the **Enable FN1 Substitution** bar code on page [5-36](#).

## Transmit “No Read” Message

Parameter # 94

SSI # 5Eh

Scan one of the following bar codes to set an option for transmitting the No Read (NR) characters:

- ✓ **NOTE** If you enable **Transmit No Read**, and also enable Symbol Code ID Character or AIM Code ID Character for [Transmit Code ID Character on page 5-32](#), the scanner appends the code ID for Code 39 to the NR message.
- ✓ **NOTE** This does not apply in presentation mode.
- **Enable No Read** - This transmits the characters NR when a successful decode does not occur before trigger release or the **Decode Session Timeout** expires. See [Decode Session Timeout on page 5-22](#).
- **Disable No Read** - This sends nothing to the host if a symbol does not decode.



**Enable No Read  
(1)**



**\*Disable No Read  
(0)**

## Unsolicited Heartbeat Interval

Parameter # 1118

SSI # F8h 04h 5Eh

The scanner can send unsolicited heartbeat messages to assist in diagnostics. To enable this parameter and set the desired unsolicited heartbeat interval, scan one of the following time interval bar codes, or scan **Set Another Interval** followed by four bar codes from [Appendix G, Numeric Bar Codes](#) that correspond to the desired number of seconds. The range is 0 - 9999.

Scan **Disable Unsolicited Heartbeat Interval** to turn off the feature.

The heartbeat event is sent as decode data (with no decode beep) in the form of:

MOTEVTHB:nnn

where **nnn** is a three-digit sequence number starting at 001 and wrapping after 100.

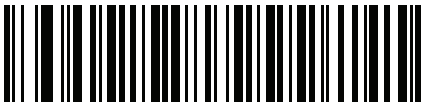

**10 Seconds**  
(10)



**1 Minute**  
(60)



**Set Another Interval**

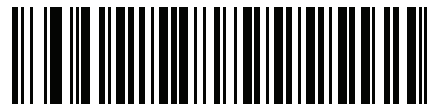

**\*Disable Unsolicited Heartbeat Interval**  
(0)

---

## Send Versions

### Software Version

Scan the following bar code to send the version of software installed in the scanner.



**Software Version**

### Serial Number

Scan the following bar code to send the scanner serial number to the host.

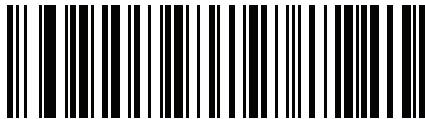

**Serial Number**

### Manufacturing Information

Scan the following bar code to send the scanner manufacturing information to the host.



**Manufacturing Information**





# CHAPTER 6 RADIO COMMUNICATIONS

---

## Introduction

This chapter provides information about the modes of operation and features available for wireless communication between the DS2278 cordless digital scanners, cradles and hosts. The chapter also includes the parameters necessary to configure the digital scanner.

The digital scanner ships with the settings shown in the [Radio Communication Default Table on page 6-2](#) (also see [Appendix A, Standard Default Parameters](#) for all defaults). If the default values suit requirements, programming is not necessary.

---

## Setting Parameters

To set feature values, scan a single bar code or a short bar code sequence. The settings are stored in non-volatile memory and are preserved even when the digital scanner powers down.

✓ **NOTE** Most computer monitors allow scanning bar codes directly on the screen. When scanning from the screen, be sure to set the document magnification to a level where you can see the bar code clearly, and bars and/or spaces do not merge.

If not using the default host, select the host type (see each host chapter for specific host information) after the power-up beeps sound. This is only necessary upon the first power-up when connected to a new host.

To return all features to default values, scan a bar code in [Default Parameters on page 5-5](#). Throughout the programming bar code menus, asterisks (\*) indicate default values.



\* Indicates default — \*Enable Parameter — Feature/option  
(1) — Option value

## Scanning Sequence Examples

In most cases, scanning one bar code sets the parameter value. For example, to enable HID Function Key Mapping, scan the **Enable HID Function Key Mapping** bar code listed under [HID Function Key Mapping on page 6-21](#). The digital scanner issues a fast warble beep and the LED turns green, signifying a successful parameter entry.

Other parameters, such as **Bluetooth Friendly Name**, require scanning several bar codes. See the parameter descriptions for this procedure.

## Errors While Scanning

Unless otherwise specified, to correct an error during a scanning sequence, just re-scan the correct parameter.

## Radio Communications Parameter Defaults

[Table 6-1](#) lists the defaults for radio communication parameters. Change these values in one of two ways:

- Scan the appropriate bar codes in this chapter. The new value replaces the standard default value in memory. To recall default parameter values, see [Default Parameters on page 5-5](#).
- Configure the digital scanner using the 123Scan configuration program. See [Chapter 2, 123Scan and Software Tools](#).

✓ **NOTE** See [Appendix A, Standard Default Parameters](#) for all user preference, host, symbology, and miscellaneous default parameters.

**Table 6-1** Radio Communication Default Table

Parameter	Parameter Number	SSI Number	Default	Page Number
Radio Communications Host Types	N/A	N/A	Cradle Bluetooth Classic (Cradle Host)	<a href="#">6-5</a>
Bluetooth Friendly Name	607	F1h 5Fh	N/A	<a href="#">6-10</a>
Discoverable Mode	610	F1h 62h	General	<a href="#">6-11</a>
Wi-Fi Friendly Mode	1299	F8h 05h 77h	Disable	<a href="#">6-12</a>
Wi-Fi Friendly Channel Exclusion	N/A	N/A	Use All Channels	<a href="#">6-13</a>
Radio Output Power	1324	F8h 05h 2Ch	Medium Power Setting	<a href="#">6-14</a>
Link Supervision Timeout	1698	F8h 06h A2h	5 sec	<a href="#">6-15</a>
Bluetooth Radio State	1354	F8h 05h 4Ah	On	<a href="#">6-16</a>
Apple iOS Virtual Keyboard Toggle	1114	F8h 04h 5Ah	Disable	<a href="#">6-17</a>
HID Keyboard Keystroke Delay	N/A	N/A	No Delay (0 msec)	<a href="#">6-18</a>
HID CAPS Lock Override	N/A	N/A	Disable	<a href="#">6-18</a>
HID Ignore Unknown Characters	N/A	N/A	Enable	<a href="#">6-19</a>

**Table 6-1** Radio Communication Default Table (Continued)

Parameter	Parameter Number	SSI Number	Default	Page Number
Emulate Keypad	N/A	N/A	Enable	6-19
Fast HID Keyboard	1361	F8h 05h 51h	Enable	6-20
Quick Keypad Emulation	1362	F8h 05h 52h	Enable	6-20
HID Keyboard FN1 Substitution	N/A	N/A	Disable	6-21
HID Function Key Mapping	N/A	N/A	Disable	6-21
Simulated Caps Lock	N/A	N/A	Disable	6-22
Convert Case	N/A	N/A	No Case Conversion	6-22
Reconnect Attempt Beep Feedback	559	F1h 2Fh	Disable	6-23
Reconnect Attempt Interval	558	F1h 2Eh	30 sec	6-24
Auto-Reconnect	604	F1h 5Ch	Auto-Reconnect Immediately	6-25
Beep on Insertion	288	20h	Enable	6-26
Beep on <BEL>	150	96	Enable	6-26
Pairing Modes	542	F1h 1Eh	Unlocked	6-27
Pairing on Contacts	545	F1h 21h	Enable	6-28
Toggle Pairing	1322	F8h 05h 2Ah	Disable	6-29
Connection Maintenance Interval	N/A	N/A	15 Minutes	6-30
Batch Mode	544	F1h 20h	Normal (Do Not Batch Data)	6-33
Persistent Batch Storage	1399	F8h 05h 77h	Disable	6-34
Bluetooth Security Levels	1393	F8h 05h 71h	Low	6-35
Save Bluetooth Connection Information	1743	F8h 06h CFh	Enable	6-39
Virtual Tether Alarm on the Scanner	2053	F8h 08h 05h	Disable	6-40
Audio Virtual Tether Alarm on Scanner	2246	F8h 08h C6h	Enable Audio Virtual Tether Alarm Except in Night Mode	6-41
LED Virtual Tether Alarm on Scanner	2247	F8h 08h C7h	Enable	6-41
Illumination Virtual Tether Alarm on Scanner	2248	8h 08h C8h	Enable	6-41
Virtual Tether Alarm Configuration on the Cradle	2124	F8h 08h 4Ch	Disable	6-43
Delay Before Virtual Tether Alarm Activates	2054	F8h 08h 06h	30 Seconds	6-43

**Table 6-1** *Radio Communication Default Table (Continued)*

<b>Parameter</b>	<b>Parameter Number</b>	<b>SSI Number</b>	<b>Default</b>	<b>Page Number</b>
Virtual Tether Alarm Duration	2055	F8h 08h 07h	5 Minutes	<a href="#">6-44</a>
Defeat Virtual Tether Alarm	2119	F8h 08h 47h	Pause Alarm on trigger on the scanner	<a href="#">6-45</a>
Pause Virtual Tether Alarm Duration	2120	F8h 08h 48h	30 Seconds	<a href="#">6-45</a>

---

## Wireless Beeper Definitions

When the digital scanner scans the pairing bar code it issues various beep sequences indicating successful or unsuccessful operations. See [Beeper and LED Indications on page 3-1](#) for all beep sequences and LED displays including those which occur during pairing operations.

---

## Radio Communication Host Types

To set up the digital scanner for communication with a cradle, or to use standard Bluetooth profiles, scan the appropriate host type bar code below.

### Bluetooth Classic vs. Low Energy Bluetooth

Low Energy (LE) Bluetooth has a smaller RF footprint which significantly improves Wi-Fi co-existence. However, LE Bluetooth is up to 7 times slower than Classic Bluetooth (0.27 Mbps versus 0.7-2.1 Mbps), so data intensive activities such as firmware update can take significantly longer.

### Cradle

Select this host type when connecting the digital scanner to the CR2278-PC communication cradle.

✓ **NOTE** The cradle pairs point-to-point (one digital scanner only).

The digital scanner automatically tries to reconnect to a remote device when a disconnection occurs that is due to the radio losing communication. See [Auto-Reconnect Feature on page 6-23](#) for more information.

To establish a connection (for initial setup only):

1. Scan the **Cradle-Bluetooth Classic** or **Cradle-Low Energy** bar code.
2. Scan the pairing bar code on the cradle or place the digital scanner in the cradle.

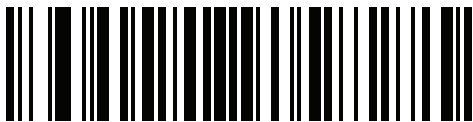

\*Cradle Bluetooth Classic

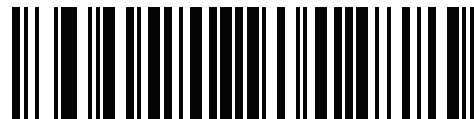

Cradle Bluetooth Low Energy

## Human Interface Device (HID) Keyboard Emulation

Select this host type when connecting to a PC/tablet/phone emulating a Bluetooth keyboard.

- **HID Bluetooth Classic** - Enables the host and digital scanner to communicate using the HID Keyboard Profile over Bluetooth Classic radio. The digital scanner(s) is discoverable (Peripheral Mode) and also supports Central Mode.

To establish a connection (initial setup only):

1. Scan the **HID Bluetooth Classic** bar code.
2. Connect to Central Mode or Peripheral Mode.
  - Central Mode - Scan a pairing bar code with the host device's MAC address.
  - Peripheral Mode - From the host, discover Bluetooth devices and select your digital scanner from the discovered device list.
- **HID Bluetooth Low Energy (Discoverable)** - Enables the host to establish a HID Keyboard Profile connection with the digital scanner over Bluetooth Low Energy radio. The digital scanner(s) is discoverable (Peripheral Mode).

To establish a connection (initial setup only):

1. Scan the **HID Bluetooth Low Energy (Discoverable)** bar code.
2. From the host discover Bluetooth devices and select your digital scanner from the discovered device list.

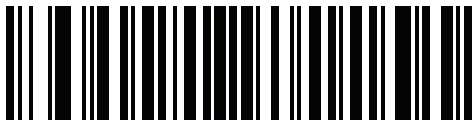

**HID Bluetooth Classic**

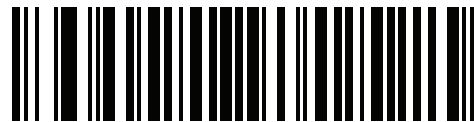

**HID Bluetooth Low Energy (Discoverable)**

## Simple Serial Interface (SSI)

Select this host type when connecting to a Zebra mobile device or PC/tablet/phone running a Zebra scanner SDK app.

- **SSI Bluetooth Classic (Non-discoverable)** - Enables communication with Zebra mobile computers. It enables the digital scanner(s) to establish a connection with the host over Bluetooth Classic radio. The digital scanner is in non-discoverable mode.

✓ **NOTE** See [Chapter 2, 123Scan and Software Tools](#) for information about the Scanner Control App to download firmware.

To establish a connection (initial setup only):

1. Scan the **SSI Bluetooth Classic (Non-discoverable)** bar code.
2. Scan a pairing bar code with the host device's MAC address.

✓ **NOTE** Additional steps may be necessary depending on host's Bluetooth stack.

- **SSI Bluetooth Classic (Discoverable)** - Enables communication with Scanner SDK for Android generated apps. It enables the host to establish a connection with the digital scanner over Bluetooth Classic radio. The digital scanner is in discoverable.

To establish a connection (initial setup only):

1. Scan the **SSI Bluetooth Classic (Discoverable)** bar code.
2. From the host, discover Bluetooth devices and select your digital scanner from your discovered device list.

- **SSI Bluetooth LE** - Enables communication and firmware downloads with apps generated using Zebra Scanner SDKs for iOS and Android. It enables the host to establish a connection with the digital scanner over a Bluetooth Low Energy radio. The digital scanner is in discoverable (Peripheral Mode) and also supports Central Mode.

- Free Demonstration App - Download Scanner Control App for iOS from the App Store.
- Free Demonstration App - Download Scanner Control App for Android from the Google Play Store.

✓ **NOTE** Go to: [www.zebra.com/scannersdk](http://www.zebra.com/scannersdk) for additional options to develop applications that can be used for communication and firmware downloads.



## Simple Serial Interface (continued)



**SSI Bluetooth Classic (Non-Discoverable)**

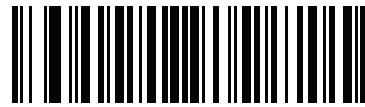

**SSI Bluetooth Classic (Discoverable)**

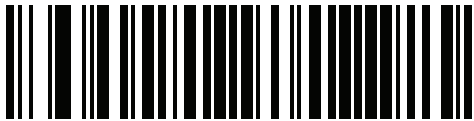

**SSI Bluetooth LE**

## Serial Port Profile (SPP)

Select this host type when connecting to a PC/tablet/phone using a Bluetooth serial connection.

- **SPP Bluetooth Classic (Non-Discoverable)** - Enables the digital scanner to establish a Serial Port Profile (SPP) connection with the host over Bluetooth Classic radio. The digital scanner is NOT discoverable (Central Mode).

To establish a connection (initial setup only):

1. Scan the **SPP Bluetooth Classic (Non-discoverable)** bar code.
2. Scan a pairing bar code with the MAC address of the host device.

- **SPP Bluetooth Classic (Discoverable)** - Enables the host to establish a Serial Port Profile (SPP) connection with the digital scanner over Bluetooth Classic radio. The digital scanner is discoverable (Peripheral Mode).

To establish a connection (initial setup only):

1. Scan the **SPP Bluetooth Classic (Discoverable)** bar code.
2. From the host, discover Bluetooth devices and select your digital scanner from the discovered device list.

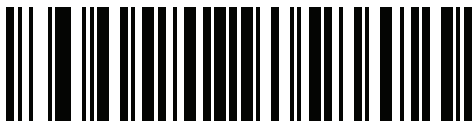

**SPP Bluetooth Classic (Non-Discoverable)**

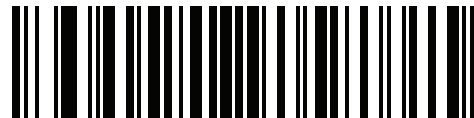

**SPP Bluetooth Classic (Discoverable)**

## Bluetooth Technology Profile Support

With Bluetooth Technology Profile Support, the cradle is not required for wireless communication. The digital scanner communicates directly to the host using Bluetooth technology. The digital scanner supports the standard Bluetooth Serial Port Profile (SPP) and HID Profiles which enable the digital scanner to communicate with other Bluetooth devices that support these profiles.

- SPP - the digital scanner connects to the PC/host via Bluetooth and performs like there is a serial connection.
- HID - the digital scanner connects to the PC/host via Bluetooth and performs like a keyboard.

## Central/Peripheral Set Up

The digital scanner can be set up as a Central or Peripheral. When the digital scanner is set up as a Peripheral, it is discoverable and connectible to other devices. When the digital scanner is set up as a Central, the Bluetooth address of the remote device to which a connection is requested is required. A pairing bar code with the remote device address must be created and scanned to attempt a connection to the remote device. See the [Pairing Using the Scan-To-Connect \(STC\) Utility on page 6-31](#) for information about creating a pairing bar code.

### Central

When the digital scanner is set up as a Central (SPP), it initiates the radio connection to a Peripheral device. Initiating the connection is done by scanning a pairing bar code for the remote device (see [Pairing Using the Scan-To-Connect \(STC\) Utility on page 6-31](#)).

### Peripheral

When the digital scanner is set up as a Peripheral device (SPP), the digital scanner accepts an incoming connection request from a remote device.

✓ **NOTE** The number of digital scanners is dependent on the host capability.

---

## Bluetooth Friendly Name

### Parameter # 607

### SSI # F1h 5Fh

You can set a meaningful name for the digital scanner that appears in the application during device discovery. The default name is the digital scanner name followed by its serial number, e.g., **DS2278 123456789ABCDEF**. Scanning **Set Defaults** reverts the digital scanner to this name; use custom defaults to maintain the user-programmed name through a **Set Defaults** operation.

To set a new Bluetooth Friendly Name, scan the following bar code, then scan up to 23 characters from [Appendix H, Alphaumeric Bar Codes](#). If the name contains less than 23 characters, Then scan **End of Message** in the [Advanced Data Formatting Guide](#).

✓ **NOTE** If your application allows you to set a device name, this takes precedence over the Bluetooth Friendly Name.

✓ **NOTE** If the scanner was discovered previously by a PC, tablet, or phone, it may take a while for the new name to show up as the PC/tablet/phone needs to update its list. Try turning the radio off and then on, or reboot the PC/tablet/phone.



Bluetooth Friendly Name

## Discoverable Mode

**Parameter # 610**

**SSI # F1h 62h**

Select a discoverable mode based on the device initiating discovery:

- Select **General Discoverable Mode** when initiating connection from a PC.
- Select **Limited Discoverable Mode** when initiating connection from a mobile device (e.g., Q), and the device does not appear in General Discoverable Mode. Note that it can take longer to discover the device in this mode.

The device remains in Limited Discoverable Mode for 30 seconds, and green LEDs flash while in this mode. It is then non-discoverable. To re-active Limited Discoverable Mode, press the trigger.



**\*General Discoverable Mode  
(0)**

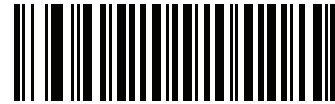

**Limited Discoverable Mode  
(1)**

### Wi-Fi Friendly Mode

Digital scanners configured for Wi-Fi friendly mode behave as follows:

- The digital scanner remains in sniff mode, and exits sniff mode only during firmware update.
- If any Wi-Fi channel is excluded from the hopping sequence, Adaptive Frequency Hopping (AFH) turns off.
- Digital scanner (and cradle) avoid the selected Wi-Fi channels after establishing connection.

#### Notes

- If using this feature, configure all digital scanners in the area for Wi-Fi friendly mode.
- By default, no Wi-Fi channels are excluded.
- Since Bluetooth requires a minimum of 20 channels when Wi-Fi channels 1, 6, and 11 are excluded, a smaller number of channels are cut from the hopping sequence.
- Updating Wi-Fi friendly settings before Bluetooth connection is recommended.

Scan a bar code below to enable or disable **Wi-Fi Friendly Mode**, then see [Wi-Fi Friendly Channel Exclusion](#) to select any channels to exclude.



**\*Disable Wi-Fi Friendly Mode**

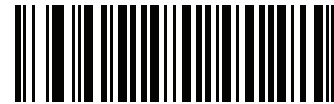

**Enable Wi-Fi Friendly Mode**

### Wi-Fi Friendly Channel Exclusion

#### Wi-Fi Channel Exclusion

Select the channels to exclude:

- **Exclude Wi-Fi channel 1:** Bluetooth channels 0-21 are excluded from hopping sequence (2402-2423 MHz).
- **Exclude Wi-Fi channel 6:** Bluetooth channels 25-46 are excluded from hopping sequence (2427 - 2448 MHz).
- **Exclude Wi-Fi channel 11:** Bluetooth channels 50-71 are excluded from hopping sequence (2452 - 2473 MHz).
- **Exclude Wi-Fi channel 1, 6 and 11:** Bluetooth channels 2-19 (2404-2421 MHz), 26-45 (2428 - 2447 MHz) and 51-69 (2453 - 2471 MHz) are excluded from hopping sequence.
- **Exclude Wi-Fi channels 1 and 6:** Bluetooth channels 0-21 (2402-2423 MHz) and 25-46 (2427 - 2448 MHz) are excluded from hopping sequence.
- **Exclude Wi-Fi channels 1 and 11:** Bluetooth channels 0-21 (2402-2423 MHz) and 50-71 (2452 - 2473 MHz) are excluded from hopping sequence.
- **Exclude Wi-Fi channel 6 and 11:** Bluetooth channels 25-46 (2427 - 2448 MHz) and 50-71 (2452 - 2473 MHz) are excluded from hopping sequence.

### Wi-Fi Friendly Channel Exclusion (continued)



**\*Use All Channels (Standard AFH)**



**Exclude Wi-Fi Channel 1**

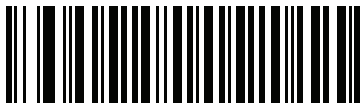

**Exclude Wi-Fi Channel 6**

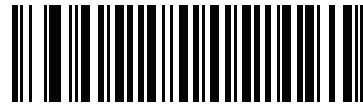

**Exclude Wi-Fi Channel 11**



**Exclude Wi-Fi Channels 1, 6, and 11**

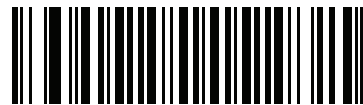

**Exclude Wi-Fi Channels 1 and 6**



**Exclude Wi-Fi Channels 1 and 11**



**Exclude Wi-Fi Channels 6 and 11**

---

## Radio Output Power

**Parameter # 1324**

**SSI # F8h 05h 2Ch**

The DS2278 uses a Class 2 Bluetooth radio (see [Technical Specifications on page 4-8](#) for detailed radio information). The radio power can be reduced to restrict the transmission range and reduce the effect of the radio on neighboring wireless systems.

✓ **NOTE** Bluetooth stack resets on power change and the device loses connection.

Scan a bar code to select the desired power mode.

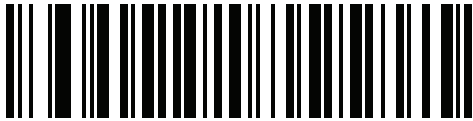

**\* Medium Power Setting  
(0)**

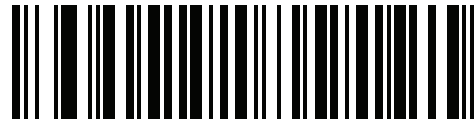

**Low Power Setting  
(1)**

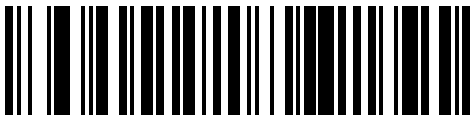

**Very Low Power Setting  
(2)**



**Ultra Low Power Setting  
(3)**

## Link Supervision Timeout

Parameter # 1698

SSI # F8h 06h A2h

Link supervision timeout controls how quickly the digital scanner senses that the Bluetooth radio lost connection to the remote device. A lower value helps prevent data loss at the edge of the operating range while a larger value helps prevent disconnects due to the remote device not responding in time. If you are experiencing occasional disconnects and the digital scanner is able to reconnect, increase the link supervision timeout value.

✓ **NOTE** The digital scanner only controls Link Supervision Timeout in Central Mode.

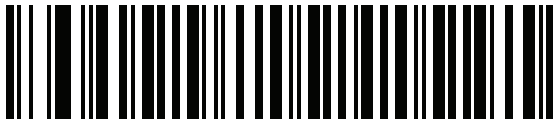

.5 Seconds

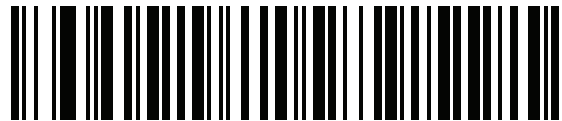

2 Seconds

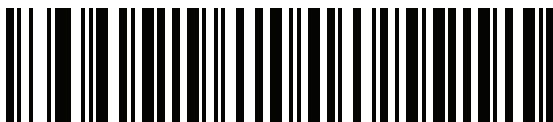

\* 5 Seconds

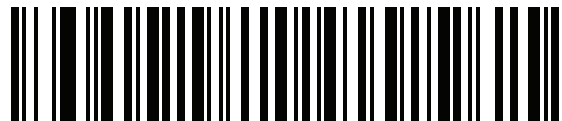

10 Seconds

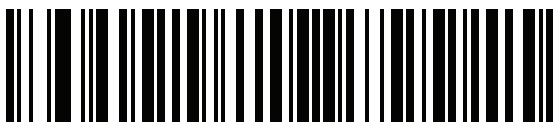

20 Seconds



---

## Bluetooth Radio State

**Parameter # 1354**

**SSI # F8h 05h 4Ah**



**NOTE** The radio on/off parameters are for both the scanner and cradle. If the scanner is NOT connected to the cradle, the scanner's radio will turn off. If the scanner is connected to the cradle, both the scanner and cradle radios will be turned off.

If the cradle radio is turned off, the only options to turn the cradle radio back on is via host command or using Parameter Batch Mode.

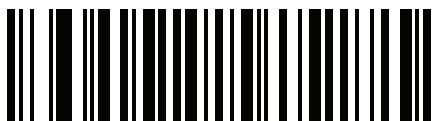

**Bluetooth Radio Off**



**\*Bluetooth Radio On**

---

## HID Host Parameters

The digital scanner supports virtual keyboard emulation for the Apple iOS, and keyboard emulation over the Bluetooth HID profile. In this mode the digital scanner can interact with Bluetooth enabled hosts supporting the HID profile as a Bluetooth keyboard. Scanned data is transmitted to the host as keystrokes.

### Apple iOS Virtual Keyboard Toggle

**Parameter # 1114**

**SSI # F8h 04h 5Ah**

This option works with Apple iOS devices to enable the opening and closing of the iOS virtual keyboard by double-pressing the trigger.



**NOTE** When this feature is enabled, the digital scanner may be incompatible with non-Apple iOS devices.



**\*Disable**  
**(0)**

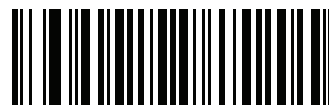

**Enable**  
**(1)**

## HID Keyboard Keystroke Delay

This parameter sets the delay, in milliseconds, between emulated keystrokes. Scan a bar code below to increase the delay when the HID host requires a slower transmission of data.

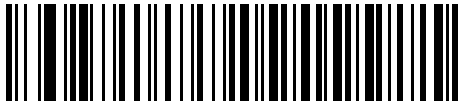

**\*No Delay (0 msec)**

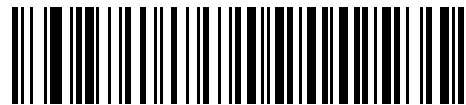

**Medium Delay (20 msec)**



**Long Delay (40 msec)**

## HID CAPS Lock Override

When enabled, the case of the data is preserved regardless of the state of the caps lock key. This setting is always enabled for the “Japanese, Windows (ASCII)” keyboard type and can not be disabled.

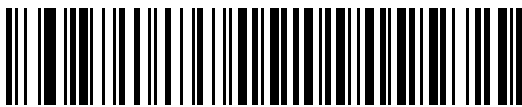

**\*Do Not Override Caps Lock Key  
(Disable)**

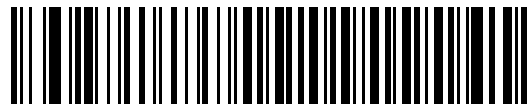

**Override Caps Lock Key  
(Enable)**

## HID Ignore Unknown Characters

This option applies only to the HID Keyboard Emulation device and IBM device. Unknown characters are characters the host does not recognize. When **Send Bar Codes With Unknown Characters** is selected, all bar code data is sent except for unknown characters, and no error beeps sound. When **Do Not Send Bar Codes With Unknown Characters** is selected, bar code data is sent up to the first unknown character, then the digital scanner issues an error beep.

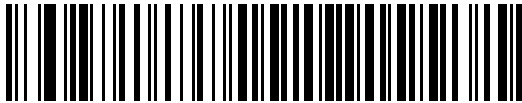

**\*Send Bar Codes With Unknown Characters  
(Enable)**

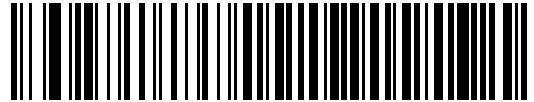

**Do Not Send Bar Codes With Unknown Characters  
(Disable)**

## Emulate Keypad

When enabled, all characters are sent as ASCII sequences over the numeric keypad. For example, ASCII A is sent as "ALT Make" 0 6 5 "ALT Break."

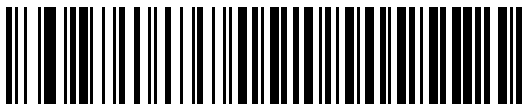

**Disable Keypad Emulation**



**\* Enable Keypad Emulation**

## Fast HID Keyboard

Parameter # 1361

SSI # F8h 05h 51h

This option transmits Bluetooth HID keyboard data at a faster rate.

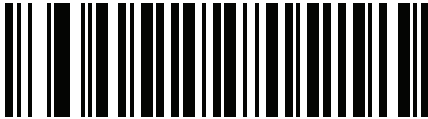

Fast HID Disable

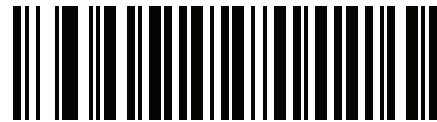

\*Fast HID Enable

## Quick Keypad Emulation

Parameter # 1362

SSI # F8h 05h 52h

✓ **NOTE** This option applies only to a HID Keyboard Emulation Device which has **Emulate Keypad** enabled (see [Emulate Keypad on page 6-19](#)).

This parameter enables a quicker method of keypad emulation where ASCII sequences are only sent for ASCII characters not found on the keyboard.

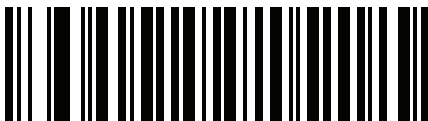

Quick Keypad Emulation Disable

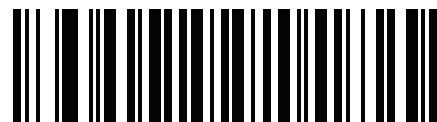

\*Quick Keypad Emulation Enable

## HID Keyboard FN1 Substitution

When enabled, this parameter allows replacement of any FN1 character in an EAN128 bar code with a Key Category and value chosen by the user. See [FN1 Substitution Values on page 5-36](#) to set the Key Category and Key Value.

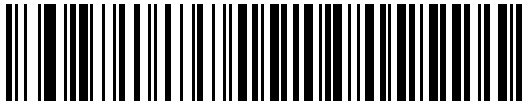

**\*Disable Keyboard FN1 Substitution**



**Enable Keyboard FN1 Substitution**

## HID Function Key Mapping

ASCII values under 32 are normally sent as control-key sequences. When this parameter is enabled, the keys in bold are sent in place of the standard key mapping (see [Table I-1 on page I-1](#)).

Table entries that do not have a bold entry remain the same whether or not this parameter is enabled.



**\*Disable Function Key Mapping**

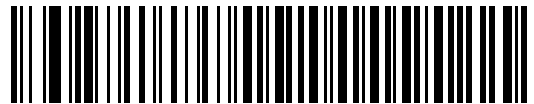

**Enable Function Key Mapping**

## Simulated Caps Lock

When enabled, the digital scanner inverts upper and lower case characters on the digital scanner bar code as if the Caps Lock state is enabled on the keyboard. This inversion is done regardless of the current state of the keyboard Caps Lock state.

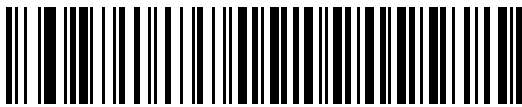

**\*Disable Simulated Caps Lock**

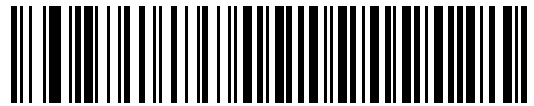

**Enable Simulated Caps Lock**

## Convert Case

When enabled, the digital scanner converts all bar code data to the selected case.

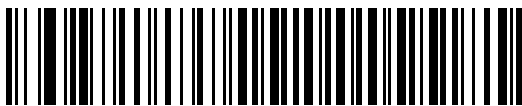

**\*No Case Conversion**

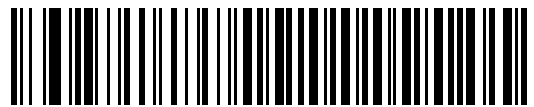

**Convert All to Upper Case**

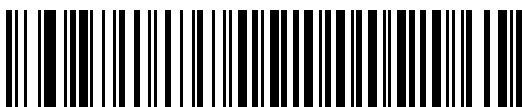

**Convert All to LowerCase**

## Auto-Reconnect Feature

When in SPP Central, Bluetooth Keyboard Emulation or when connected to the cradle (Cradle Host Mode), the digital scanner automatically tries to reconnect to a remote device when a disconnection occurs that is due to the radio losing communication. This can happen if the digital scanner goes out of range with the remote device, or if the remote device powers down. The digital scanner tries to reconnect for the period of time specified by the Reconnect Attempt Interval setting. During that time the green LED continues to blink.

If the auto-reconnect process fails due to page timeouts, the digital scanner sounds a page timeout beep (long low/long high) and enters low power mode. The auto-reconnect process can be re-started by pulling the digital scanner trigger.

If the auto-reconnect process fails because the remote device rejects the connection attempt, the digital scanner sounds a connection reject beep sequence (see [Wireless Beeper Definitions on page 6-5](#)) and deletes the remote pairing address. If this happens, a pairing bar code must be scanned to attempt a new connection to the remote device.

- ✓ **NOTE** If a bar code is scanned while the auto-reconnect sequence is in process, a transmission error beep sequence sounds and the data is not transmitted to the host. After a connection is reestablished, normal scanning operation returns. For error beep sequence definitions, see [Beeper and LED Indications on page 3-1](#).

The digital scanner has memory available for storing a remote Bluetooth address for each Central Mode (SPP, Cradle). When switching between these modes, the digital scanner automatically tries to reconnect to the last device it was connected to in that mode.

- ✓ **NOTE** Switching between Bluetooth host types by scanning a host type bar code ([page 6-5](#)) causes the radio to be reset. Scanning is disabled during this time. It takes several seconds for the digital scanner to re-initialize the radio at which time scanning is enabled.

## Reconnect Attempt Beep Feedback

### Parameter # 559

#### SSI # F1h 2Fh

When a digital scanner disconnects as it goes out of range, it immediately attempts to reconnect. While the digital scanner attempts to reconnect, the green LED continues to blink. If the auto-reconnect process fails, the digital scanner emits a page timeout beep (long low/long high) and stops blinking the LED. The process can be restarted by pulling the trigger.

The Beep on Reconnect Attempt feature is disabled by default. When enabled, the digital scanner emits 5 short high beeps every 5 seconds while the re-connection attempt is in progress. Scan a bar code below to enable or disable Beep on Reconnect Attempt.



\*Disable Beep on Reconnect Attempt  
(0)



Enable Beep on Reconnect Attempt  
(1)



## Reconnect Attempt Interval

**Parameter # 558**

**SSI # F1h 2Eh**

When a digital scanner disconnects as it goes out of range, it immediately attempts to reconnect for the default time interval of 30 seconds. This time interval can be changed to one of the options below.

To set the Reconnect Attempt Interval, scan one of the bar codes below.

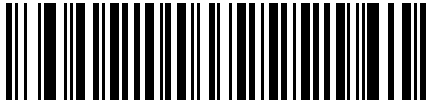

**\*Attempt to Reconnect for 30 Seconds  
(6)**



**Attempt to Reconnect for 1 Minute  
(12)**



**Attempt to Reconnect for 5 Minutes  
(60)**



**Attempt to Reconnect for 30 Minutes  
(360)**



**Attempt to Reconnect for 1 Hour  
(720)**



**Attempt to Reconnect Indefinitely  
(0)**

## Auto-Reconnect

### Parameter # 604

#### SSI # F1h 5Ch

In Bluetooth Keyboard Emulation (HID) mode, SPP Central, and when connected to the cradle (Cradle Host Mode), select a re-connect option for when the digital scanner loses its connection with a remote device:

- **Auto-Reconnect on Bar Code Data:** The digital scanner auto-reconnects when you scan a bar code. With this option, a delay can occur when transmitting the first characters. The digital scanner sounds a decode beep upon bar code scan, followed by a connection, a page timeout, a rejection beep, or a transmission error beep. Select this option to optimize battery life on the digital scanner and mobile device. Note that auto-reconnect does not occur on rejection and cable unplug commands.
- **Auto-Reconnect Immediately:** When the digital scanner loses connection, it attempts to reconnect. If a page timeout occurs, the digital scanner attempts reconnect on a trigger pull. Select this option if the digital scanner battery life is not an issue and you do not want a delay to occur when the first bar code is transmitted. Note that auto-reconnect does not occur on rejection and cable unplug commands.
- **Disable Auto-Reconnect:** When the digital scanner loses connection, you must re-establish it manually.

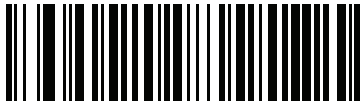

**Auto-Reconnect on Bar Code Data**  
(1)

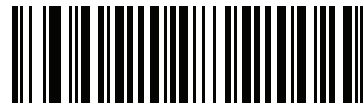

**\*Auto-Reconnect Immediately**  
(2)

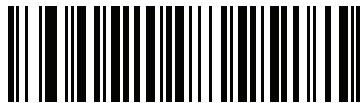

**Disable Auto-Reconnect**  
(0)

---

## Out of Range Indicator

An out of range indicator can be set by scanning [Enable Beep on Reconnect Attempt \(1\) on page 6-23](#) and extending the time using the [Reconnect Attempt Interval on page 6-24](#).

For example, with Beep on Reconnect Attempt disabled while the digital scanner loses radio connection when it is taken out of range, the digital scanner attempts to reconnect silently during the time interval set by scanning a Reconnect Attempt Interval.

When Beep on Reconnect Attempt is enabled, the digital scanner emits 5 high beeps every 5 seconds while the re-connection attempt is in progress. If the Reconnect Attempt Interval is adjusted to a longer period of time, such as 30 minutes, the digital scanner emits 5 high beeps every 5 seconds for 30 minutes providing an out of range indicator.

---

## Beep on Insertion

**Parameter # 288**

**SSI # 20h**

When a digital scanner is inserted into a cradle and detects power, it emits a short low beep. This feature is enabled by default.

To enable or disable beeping on insertion, scan the appropriate bar code below.



**\*Enable Beep on Insertion  
(1)**



**Disable Beep on Insertion  
(0)**

---

## Beep on <BEL>

**Parameter # 150**

**SSI # 96h**

When this parameter is enabled, the digital scanner issues a beep when a <BEL> character is detected on the serial line. <BEL> is issued to gain a user's attention to an illegal entry or other important events.

✓ **NOTE** This parameter only applies to SPP (Serial Port Profile). The RS-232 interface on the cradle has this feature when Beep on <BEL> is enabled.

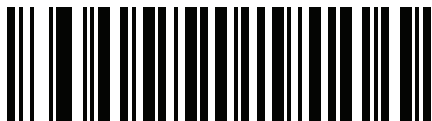

**\*Beep on <BEL> Enable**



**Beep on <BEL> Disable**

## Digital Scanner To Cradle Support

### Pairing

Pairing is the process by which a digital scanner initiates communication with a cradle.

To pair the digital scanner with the cradle, scan the pairing bar code. A high/low/high/low beep sequence indicates that the pairing bar code was decoded. When a connection between the cradle and digital scanner is established, a low/high beep sounds.



**NOTE 1.** The pairing bar code that connects the digital scanner to a cradle is unique to each cradle.

**2.** Do not scan data or parameters until pairing completes.

**3.** Only when the digital scanner is paired to the cradle, it automatically tries to reconnect to a remote device when a disconnection occurs that is due to the radio losing communication. For more information see [Auto-Reconnect Feature on page 6-23](#).

### Pairing Modes

#### Parameter # 542

#### SSI # F1h 1Eh

When operating with the cradle, two modes of pairing are supported:

- **Locked Point-to-Point Pairing Mode** - When a cradle is paired (connected) to the digital scanner, any attempt to connect a different digital scanner, by either scanning the **PAIR** bar code on the cradle or by inserting it into the cradle with the pairing on contacts feature enabled ([page 6-28](#)), is rejected. The currently connected digital scanner maintains connection. In this mode, you must set a [Connection Maintenance Interval on page 6-29](#).
- **Unlocked Point-to-Point Pairing Mode** - Pair (connect) a new digital scanner to a cradle at any time by either scanning the **PAIR** bar code on the cradle or by inserting it into the cradle with the pairing on contacts feature enabled. This unpairs the previous digital scanner from the cradle.

To set the cradle pairing mode, scan the appropriate bar code below.

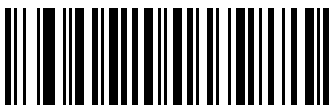

\*Unlocked Pairing Mode  
(0)



Locked Pairing Mode  
(1)

### Lock Override

**Lock Override** overrides a locked digital scanner base pairing and connects a new digital scanner. To use **Lock Override**, scan the bar code below, followed by the pairing bar code on the cradle.



Lock Override

## Pairing Methods

**Parameter # 545**

**SSI # F1h 21h**

There are two methods available to pair (connect) the scanner to the cradle:

- Scan the pairing bar code on the cradle
- or
- Pair on contacts by inserting the scanner into the cradle.

When the Bluetooth connection beeps sound, the scanner and cradle connect. See [Wireless Beeper Definitions on page 6-5](#) for other beep sequences.

Enable or disable **Pair on Contacts** by scanning the appropriate bar code below.



**NOTE** When **Pair on Contacts** is enabled you may still scan the pairing bar code on the cradle.



**\*Enable Pair On Contacts  
(1)**



**Disable Pair on Contacts  
(0)**

## Pull Trigger Twice to Re-connect



**IMPORTANT** This feature only applies to hosts capable of a commanded connection; SPP peripheral and HID BLE hosts do not support this feature.

Upon a double trigger press, the scanner attempts to connect to the last known address. This feature differs from auto-reconnect (see [Auto-Reconnect Feature on page 6-23](#)) in that the scanner attempts connection only once and keeps the address even on commanded disconnect. The last known address is only cleared upon a reject or with a new successful connection. The address persists over scanner reboot.



**NOTE** This feature does not interfere with a double trigger press to open/close an iOS keypad in HID mode.

## Unpairing

- ✓ **NOTE** When unpairing the digital scanner In Bluetooth Low Energy mode the host may issue a connection back to the digital scanner after digital scanner disconnects.

Unpair the digital scanner from the cradle or PC/host to make the cradle available for pairing with another digital scanner. Scan the bar code below to disconnect the digital scanner from its cradle/PC host.

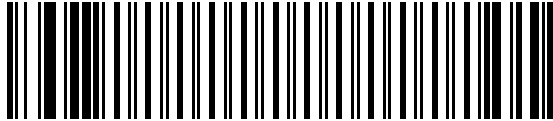

Unpairing

## Toggle Pairing

Parameter # 1322

SSI # F8h 05h 2Ah

If the digital scanner is configured for Toggle Pairing, scanning the Pairing bar code a second time unpairs the scanner.

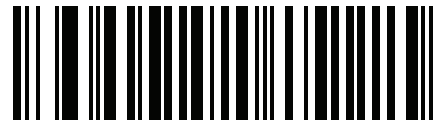

\*Toggle Pairing Disable

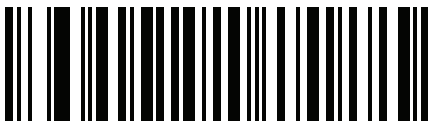

Toggle Pairing Enable

## Connection Maintenance Interval

- ✓ **NOTE** The Connection Maintenance Interval only applies in locked pairing mode (see [page 6-27](#)).

When a digital scanner disconnects from a cradle due to a Link Supervision Timeout, the digital scanner immediately attempts to reconnect to the cradle for 30 seconds. If the auto-reconnect process fails, it can be restarted by pulling the digital scanner trigger.

To guarantee that a disconnected digital scanner can reconnect when it comes back in range, the cradle reserves the connection for that digital scanner for a period of time defined by the Connection Maintenance Interval. To connect another digital scanner: either wait until the connection maintenance interval expires then scan the **PAIR** bar code on the cradle with the new digital scanner; or, scan **Lock Override** ([page 6-27](#)) with the new digital scanner then scan the **PAIR** bar code on the cradle.

- ✓ **NOTE** The cradle stores the remote pairing address of each digital scanner in memory regardless of the digital scanner condition (e.g., discharged battery). When you want to change the digital scanners paired to the cradle, unpair each digital scanner currently connected to the cradle by scanning the **Unpairing** bar code prior and reconnect each appropriate digital scanner by scanning the **PAIR** bar code on the cradle.

## Considerations

The system administrator determines the Connection Maintenance Interval. A shorter interval allows new users to gain access to abandoned connections more quickly, but causes problems if users leave the work area for extended periods. A longer interval allows existing users to leave the work area for longer periods of time, but ties up the system for new users.

To avoid this conflict, users who are going off-shift can scan the unpair bar code on [page 6-29](#) to ignore the Connection Maintenance Interval and make the connection immediately available.

To set the Connection Maintenance Interval, scan one of the bar codes below.

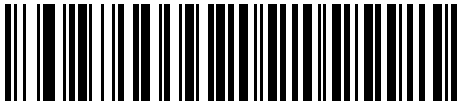

**\*Set Interval to 15 Minutes  
(0)**

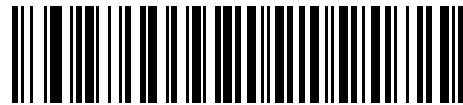

**Set Interval to 30 Minutes  
(1)**



**Set Interval to 60 Minutes  
(2)**

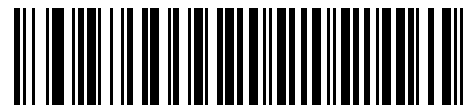

**Set Interval to 2 Hours  
(3)**



**Set Interval to 4 Hours  
(4)**

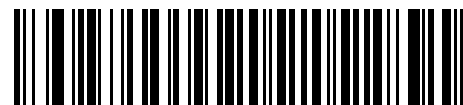

**Set Interval to 8 Hours  
(5)**

## Connection Maintenance Interval (continued)

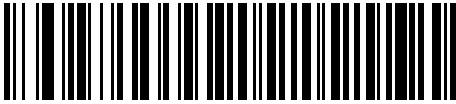

Set Interval to 24 Hours  
(6)



Set Interval to Forever  
(7)

---

## Pairing Using the Scan-To-Connect (STC) Utility

- ✓ **NOTE** Pairing using the STC utility is not supported when using a serial port interface connection. When using a serial port connection, pair with [Pairing Bar Code Format for Serial Port Connections](#).

Use the STC utility to pair in one step by connecting the Zebra Bluetooth scanner to a phone, tablet, or PC by scanning an STC bar code.

- Windows: Go to [www.zebra.com/support](http://www.zebra.com/support); search for Scan-To-Connect; select the Scan-To-Connect link; select the Scan-To-Connect for Windows Download and Support link.
- Android: Go to the Google Play Store at [play.google.com/store](http://play.google.com/store) and download the Zebra Scan-To-Connect (STC) utility.

The STC utility is available as a standalone utility. Supported operating systems include Windows and Android.

For more information, go to [www.zebra.com/scantoconnect](http://www.zebra.com/scantoconnect). Source code is also available for easy app integration.

---

## Pairing Bar Code Format for Serial Port Connections

When using a serial port connection and the digital scanner is configured as an SPP Central, you must create a pairing bar code for the remote Bluetooth device to which the digital scanner can connect. The Bluetooth address of the remote device must be known. Pairing bar codes are Code 128 bar codes and are formatted as follows:

<Fnc 3>Bxxxxxxxxxxx

where:

- **B** (or **LNKB**) is the prefix
- xxxxxxxxxxxx represents the 12-character Bluetooth address.

### Pairing Bar Code Example

If the remote device to which the digital scanner can connect has a Bluetooth address of 11:22:33:44:55:66, then the pairing bar code is:



Pairing Bar Code Content: **B112233445566**  
 'B' + Bluetooth Address



## Batch Mode

### Parameter # 544

### SSI # F1h 20h



**IMPORTANT** Batch mode does not apply to SPP Peripheral Mode.

The digital scanner supports five versions of batch mode. When the digital scanner is configured for any of the batch modes, it attempts to store bar code data (not parameter bar codes) until transmission is initialized, or the maximum number of bar codes are stored. When a bar code is saved successfully, a good decode beep sounds and the LED flashes green. If the digital scanner is unable to store a new bar code, a low/high/low/high out of memory beep sounds. (See page 3-1 for all beeper and LED definitions.)

In all modes, calculate the amount of data (number of bar codes) the digital scanner can store as follows:

Number of storable bar codes = 30,720 bytes of memory / (number of characters in the bar code + 3).

- ✓ **NOTE** If the batch mode selection is changed while there is batched data, the new batch mode takes effect only after all the previously batched data is sent.

## Modes of Operation

- **Normal (default)** - Do not batch data. The digital scanner attempts to transmit every scanned bar code.
- **Out of Range Batch Mode** - The digital scanner starts storing bar code data when it loses its connection to a remote device (for example, when a user holding the digital scanner walks out of range). Data transmission is triggered by reestablishing the connection with the remote device (for example, when a user holding the digital scanner walks back into range).
  - ✓ **NOTE** Do not use **Out of Range Batch Mode** together with the **Auto-Reconnect on Bar Code Data** (see [Auto-Reconnect on page 6-25](#)). If used together, the decoded scanned data is batched and does not allow the scanner to reconnect.
- **Standard Batch Mode** - The digital scanner starts storing bar code data after **Enter Batch Mode** is scanned. Data transmission is triggered by scanning **Send Batch Data**.
  - ✓ **NOTE** Transmission is halted if the connection to the remote device is lost.
- **Cradle Contact Batch Mode** - The digital scanner starts storing bar code data when **Enter Batch Mode** is scanned. Data transmission is triggered by insertion of the digital scanner into the cradle.
  - ✓ **NOTE** If the digital scanner is removed from the cradle during batch data transfer, transmission halts until the digital scanner is re-inserted in the cradle.
- **Batch Only Mode** - The digital scanner radio is turned off and the digital scanner stores all bar code data. Data transmission is triggered by insertion of the digital scanner into the cradle.
  - ✓ **NOTE** If the digital scanner is removed from the cradle during batch data transfer, transmission halts until the digital scanner is re-inserted in the cradle.

The radio may be turned off as batch data is transmitted over the cradle contacts.

This mode can only be exited by scanning **Normal** (default) mode.

## Modes of Operation (continued)

- **Parameter Batch Mode** - When Parameter Batch Mode is enabled, the digital scanner stores parameter bar code data intended for the cradle. When the digital scanner is inserted into a cradle, the batched parameter data is sent over the cradle contacts, and the mode is disabled. This may be needed when the cradle and/or digital scanner is configured with its radio turned off.

If a bar code is scanned while batch data is transmitted it is appended to the end of the batched data; parameter bar codes are not stored.

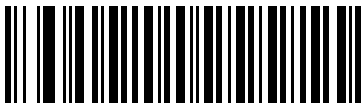

**\*Normal**  
**(00h)**

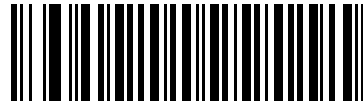

**Out of Range Batch Mode**  
**(01h)**

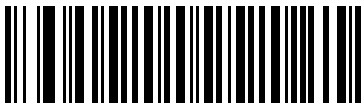

**Standard Batch Mode**  
**(02h)**

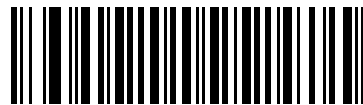

**Cradle Contact Batch Mode**  
**(03h)**

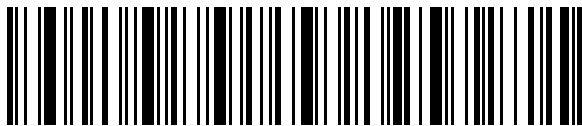

**Enter Batch Mode**

## Modes of Operation (continued)



Send Batch Data

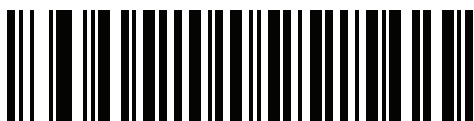

Batch Only Mode



Enter Parameter Batch Mode



Exit Parameter Batch Mode

---

## Persistent Batch Storage

Parameter #1399

SSI # F8h 05h 77h

When the digital scanner is configured for Persistent Batch Storage, batch data is stored in non-volatile memory and preserved even when the digital scanner is powered down. This parameter is Disabled by default.

✓ **NOTE** Frequently storing batch data with this setting *Enabled* will shorten the life of the non-volatile memory.

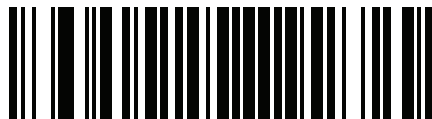

\* Persistent Batch Disable  
(0)



Persistent Batch Enable  
(1)

---

## Bluetooth Security

- ✓ **NOTE** It is recommended that security settings are configured before connection is established. When changing security settings ensure to delete the scanner from the remote host.

The digital scanner supports Bluetooth Authentication. Authentication can be requested by either the remote device or the digital scanner.

- ✓ **NOTE** A remote device can still request Authentication.

### Bluetooth Security Levels

**Parameter # 1393**

**SSI # F8h 05h 71h**

For more information on Bluetooth security, see Chapter 3 of the Guide to Bluetooth Security:

[nvlpubs.nist.gov/nistpubs/SpecialPublications/NIST.SP.800-121r2.pdf](http://nvlpubs.nist.gov/nistpubs/SpecialPublications/NIST.SP.800-121r2.pdf)

- ✓ **NOTE** Data sent over Bluetooth is encrypted in all security modes.
- **Low Bluetooth Security (default)** - The low security setting is designed for ease of connection with most devices and minimal user interaction. Uses "Just Works" secure and simple pairing method with no man in the middle protection. Provides level 2 security (as per Guide to Bluetooth Security).
  - **Medium Bluetooth Security** - The medium security setting requires a passkey for the initial connection to pair scanner to remote host. Uses "Passkey Entry" secure and simple pairing method with man in the middle protection. Provides level 3 security (as per Guide to Bluetooth Security).
  - **High Bluetooth Security** - The high security setting requires "Secure Connections" (AES-128) between scanner and remote host. Scanning in of a passkey is required. Scanner only supports high security when configured for Bluetooth Low Energy host. Provides level 4 security (as per Guide to Bluetooth Security).
- ✓ **NOTE** If connecting to a cradle when using a medium or high-security setting, place the scanner in the cradle for initial pairing.

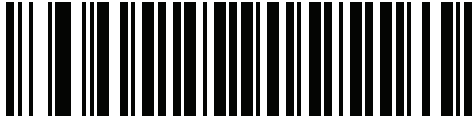

**\*Low Bluetooth Security**

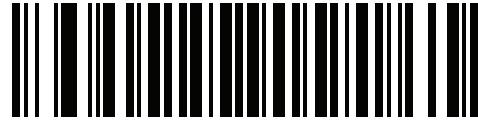

**Medium Bluetooth Security**

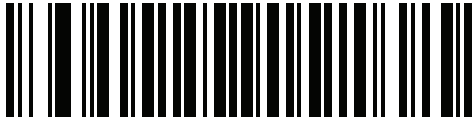

**High Bluetooth Security**

---

## Bluetooth Radio, Linking, and Batch Operation

The DS2278 digital scanner has a Bluetooth Class 2 radio which achieves a range of at least 10.0 m/33 ft (open air, line of sight). The actual range you achieve is influenced by the presence of other radios, shelving and wall materials as well as which cradle is tested. The environments vary widely and often influence radio ranges.

When the digital scanner goes out of communications range to the base, it can be configured for Batch Mode (see [Batch Mode on page 6-32](#)). The digital scanner has sufficient onboard memory to store 500 bar codes of typical size (UPC/EAN).

### Setting Up an iOS or Android Product To Work With The Digital Scanner

Perform the following steps on each device to establish a link.

#### HID Keyboard Emulation

1. On the DS2278, scan [Human Interface Device \(HID\) Keyboard Emulation on page 6-6](#).
2. On an iOS/iPad/iPhone, select *Settings > General > Bluetooth* and turn Bluetooth On. Choose the DS2278 digital scanner from the list of discovered devices. A link should be established allowing scanning into any application with keyboard entry.
3. On an Android/ET1/Droid, select *Settings > Wireless & networks > Bluetooth* (to turn Bluetooth on, if not already on). Select *Bluetooth Settings* and choose the DS2278 digital scanner from the list of discovered devices. (The DS2278 digital scanner normally displays as DS2278 - xxxxxx, where xxxxxx is the serial number.)

## Setting Up a Windows Product To Work With The Digital Scanner

Perform the following steps on each device to establish a link.

### Serial Port Bluetooth Classic (Non-discoverable)

1. Select the **Bluetooth** icon in the PC task tray to open the **Bluetooth Settings** window.
2. Make sure Bluetooth settings are discoverable and connectible on the PC.
3. If settings were changed, reboot the PC.
4. Set up an incoming COM port. You can use an existing incoming port if one is already setup.
5. Open the incoming COM port with a serial application, such as Hyperterm.
6. Scan [SPP Bluetooth Classic \(Non-Discoverable\) on page 6-9](#).
7. Make sure CoreScanner is not running.  
To stop CoreScanner service:
  - a. Select the Windows **Start** icon in the bottom left corner of the screen and type Services in the **Search** text box.
  - b. Press Enter.
  - c. Select CoreScanner in the list and select **Stop the service**.
8. Scan the pairing bar code (see [Pairing Bar Code Format for Serial Port Connections on page 6-31](#)).
9. Accept the connection request which displays in the bottom right corner of the window.
10. Wait for the connection beep to sound from the scanner.

---

## Save Bluetooth Connection Information

**Parameter # 1743**

**SSI # F8h 06h CFh**

Scan a bar code below to enable or disable the digital scanner's ability to save Bluetooth connection information.

- **Enable Bluetooth Connection Information:** The digital scanner saves the last connection and attempts to reconnect after a battery swap (power cycle) if it is set to auto-reconnect. See the [Auto-Reconnect Feature on page 6-23](#) for more information.
- **Disable Bluetooth Connection Information:** The digital scanner does not save the last connection to permanent memory and does NOT reconnect after a battery swap (power cycle). Note that depending on auto-reconnect settings the digital scanner still reconnects on going out of range and other conditions where connection is lost but auto-reconnect is desired.

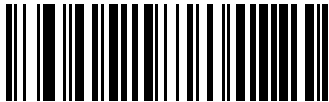

**\*Enable Bluetooth Connection Information**



**Disable Bluetooth Connection Information**



---

## Virtual Tether

Virtual Tether feature allows the scanner, cradle or host application to alert users when Bluetooth connection is lost. It works by independently controlling the scanner's illumination, audio, and LEDs.

To adjust the range of the scanner and cradle connection, change the radio power. See [Radio Output Power on page 6-14](#) for more information.

### Virtual Tether Alarm on the Scanner

#### Parameter # 2053 (SSI # F8h 08h 05h)

The Virtual Tether alarm on the scanner:

- The alarm includes audio, LED, and illumination.
- Each Alarm Type (Audio, LED, Illumination) can be enabled or disabled using the bar codes in this section. This allows for creation of custom alarms.
- This feature is disabled by default.



**\*Disable Virtual Tether Alarm on the Scanner  
(0)**



**Enable Virtual Tether Alarm on the Scanner  
(1)**

**Audio Virtual Tether Alarm on Scanner****Parameter #2246 (SSI # F8h 08h C6h)**

Scan the bar codes below to disable or enable the Audio Virtual Tether Alarm on the scanner. When the Virtual Tether is enabled, the audio beeper sounds at high volume.



**Disable Audio Virtual Tether Alarm  
(0)**

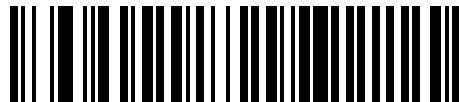

**\*Enable Audio Virtual Tether Alarm  
(1)**

**LED Virtual Tether Alarm on Scanner****Parameter #2247 (SSI # F8h 08h C7h)**

Scan the bar codes below to disable or enable the LED Virtual Tether Alarm on the scanner. When enabled, the scanner LEDs blink green and red.



**Disable LED Virtual Tether Alarm  
(0)**



**\*Enable LED Virtual Tether Alarm  
(1)**

**Illumination Virtual Tether Alarm on Scanner****Parameter #2248 (SSI # F8h 08h C8h)**

Scan the bar codes below to disable or enable the Illumination Virtual Tether Alarm on the scanner.

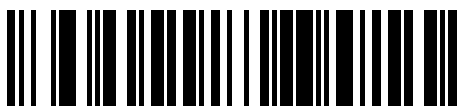

**Disable Illumination Virtual Tether Alarm**  
**(0)**

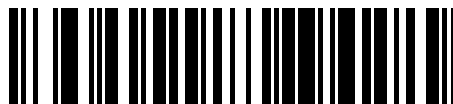

**\*Enable Illumination Virtual Tether Alarm**  
**(1)**

## Virtual Tether Alarm on the Cradle

### Parameter #2124 (SSI # F8h 08h 4Ch)

Scan the bar codes below to disable or enable the Virtual Tether Alarm on the cradle. When enabled, the cradle LEDs blink green and red.



\*Disable Virtual Tether Alarm on the Cradle  
(0)



Enable Visual Virtual Tether Alarm on the Cradle  
(2)

## Delay Before Virtual Alarm Activates

### Parameter #2054 (SSI # F8h 08h 06h)

When the device is out of range, it holds off on sounding the Virtual Tether alarm to provide an opportunity to re-establish a connection (5 - 99 seconds). The default is 30 seconds.

- ✓ **NOTE** Ensure that this setting is not too short in order to avoid the following:
- If the cradle resets, it causes the scanner to activate the Virtual Tether alarm.
  - Noisy RF environments can lead to frequent, momentary disconnect/reconnect sequences.

To set a timeout:

1. Scan the **Delay Before Alarm Activates** bar code.
2. Scan two bar codes from [Appendix G, Numeric Bar Codes](#) that correspond to the desired timeout duration. Enter a leading zero for single digit numbers (for example, for an alarm to start after 5 seconds, scan the 0 bar code and then the 5 bar code).

To correct an error or change the selection, scan *Cancel on page H-1*.



Delay Before Alarm Activates

## Virtual Tether Alarm Duration

### Parameter #2055 (SSI # F8h 08h 07h)

Set up the amount of time for the Alarm to play in minutes (1 - 99 minutes). The default is 5 minutes.

To set a timeout:

1. Scan the **Alarm Duration** bar code.
2. Scan two bar codes from [Appendix G, Numeric Bar Codes](#) that correspond to the desired alarm duration. Enter a leading zero for single digit numbers (for example, for an alarm to start after 5 minutes, scan the 0 bar code and then the 5 bar code). The value of zero sets the duration to **Infinite**.

To correct an error or change the selection, scan [Cancel on page H-1](#).



**Alarm Duration**

### Stopping the alarm

The alarm stops once the connection is established, the timeout period expires, or the scanner's battery is drained.

- ✓ **NOTE** Any connection stops the alarm. The scanner does not need to connect to the same cradle.

## Defeat Virtual Tether Alarm

### Parameter #2119 (SSI # F8h 08h 47h)

Pressing the trigger on the scanner can be configured to defeat or pause the alarm.



Do Not Defeat Alarm  
(0)

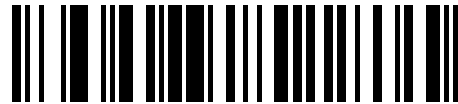

\*Pause Alarm on Trigger Pull  
(1)



Stop Alarm on Trigger Pull  
(2)

## Pause Virtual Tether Alarm Duration

### Parameter #2120 (SSI # F8h 08h 48h)

Pressing the trigger on the scanner pauses the alarm for a programmable number of seconds (1 - 99 seconds). The default is **30 seconds**.

To set a timeout:

1. Scan the **Pause Virtual Tether Alarm Duration** bar code.
2. Scan two bar codes from [Appendix G, Numeric Bar Codes](#) that correspond to the desired alarm duration. Enter a leading zero for single digit numbers (for example, for an alarm to start after 5 seconds, scan the 0 bar code and then the 5 bar code).

To correct an error or change the selection, scan *Cancel on page H-1*.



Pause Virtual Tether Alarm Duration

### Virtual Tether Alarm Considerations

- Causes for the alarm to activate include:
  - Device going out of range. Depending on configuration, both scanner and cradle can alarm if connection between them is broken due to one of the devices going out of range.
  - If cradle is unpowered, the scanner sounds the alarm. Includes USB suspend of the cradle.
  - Removing battery from the scanner will cause the cradle to sound the alarm.
- Causes for the alarm to not activate:
  - Scanner and cradle need to have an existing connection before alarm activates. No alarm on power up.
  - If the scanner is charging in or paired to another cradle/host by insertion or by scanning the pairing bar code, since it is presumed that in this case the scanner is not lost.
  - If another scanner connects to the cradle and causes the original scanner to disconnect.
  - If any of the batch modes are enabled or if auto-reconnect is NOT set to reconnect immediately.
  - Virtual Tether does not apply to the hosts that do not support auto-reconnect feature such as HID Bluetooth Low Energy (Discoverable) and SPP BT Classic (Discoverable).
  - Alarm is not activated if the disconnection occurs due to firmware update or configuration via 123Scan or SMS.
  - If scanner is connected to another cradle/host by insertion or by scanning the pairing barcode.
- Battery Preservation Mode:
  - If the scanner disconnects from the cradle due to the activation of the Battery Preservation Mode and the Virtual Tether Alarm on the cradle is enabled, only the LEDs on the cradle blink green and red.

# CHAPTER 7 SIGNATURE CAPTURE PREFERENCES

---

## Introduction

You can program the digital scanner to perform various functions, or activate different features. This chapter describes signature capture preference features and provides programming bar codes for selecting these features.

The digital scanner ships with the settings shown in [Table 7-1 on page 7-2](#) (also see [Appendix A, Standard Default Parameters](#) for all defaults). If the default values suit requirements, programming is not necessary.

- ✓ **NOTE** Although the DS2278 digital scanner supports signature capture, the quality of the image is not guaranteed. If the image does not meet your needs it is recommended that you upgrade to a DS8178 scanner.

---

## Setting Parameters

To set feature values, scan a single bar code or a short bar code sequence. The settings are stored in non-volatile memory and are preserved even when the imager powers down.

- ✓ **NOTE** Most computer monitors allow scanning bar codes directly on the screen. When scanning from the screen, be sure to set the document magnification to a level where you can see the bar code clearly, and bars and/or spaces do not merge.

To return all features to default values, scan the [Set Factory Defaults on page 5-5](#). Throughout the programming bar code menus, asterisks (\*) indicate default values.

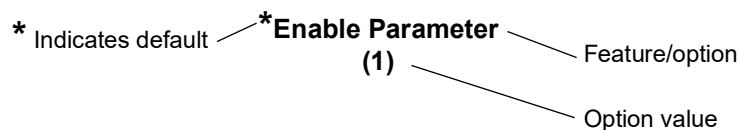
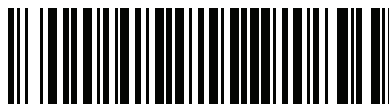



## Scanning Sequence Examples

In most cases scanning one bar code sets the parameter value. For example, to enable signature capture, scan the **Enable Signature Capture** bar code under [Signature Capture on page 7-3](#). The digital scanner issues a fast warble beep and the LED turns green, signifying a successful parameter entry.

Other parameters require scanning several bar codes. See the parameter descriptions for this procedure.

## Errors While Scanning

Unless otherwise specified, to correct an error during a scanning sequence, just re-scan the correct parameter.

## Signature Capture Preferences Parameter Defaults

[Table 7-1](#) lists defaults for image capture preference parameters. Change these values in one of two ways:

- Scan the appropriate bar codes in this chapter. The new value replaces the standard default value in memory. To recall default parameter values, see [Default Parameters on page 5-5](#).
- Configure the scanner using the 123Scan configuration program. See [Chapter 2, 123Scan and Software Tools](#).

✓ **NOTE** See [Appendix A, Standard Default Parameters](#) for all user preference, host, symbology, and miscellaneous default parameters.

See [Appendix K, Signature Capture Code](#) for signature capture code information.

**Table 7-1** Signature Capture Preferences Parameter Defaults

Parameter	Parameter Number <sup>1</sup>	SSI Number <sup>2</sup>	Default	Page Number
<b>Signature Capture Preferences</b>				
Signature Capture	93	5Dh	Disable	<a href="#">7-3</a>
Signature Capture File Format Selector	313	F0h 39h	JPEG	<a href="#">7-4</a>
Signature Capture Bits per Pixel (BPP)	314	F0h 3Ah	8 BPP	<a href="#">7-5</a>
Signature Capture Width	366	F4h F0h 6Eh	400	<a href="#">7-6</a>
Signature Capture Height	367	F4h F0h 6Fh	100	<a href="#">7-6</a>
Signature Capture JPEG Quality	421	F0h A5h	65	<a href="#">7-6</a>

1. Parameter number decimal values are used for programming via RSM commands.
2. SSI number hex values are used for programming via SSI commands.

---

## Signature Capture Preferences

The parameters in this chapter control signature capture characteristics.

### Signature Capture

#### Parameter # 93

#### SSI # 5Dh

A signature capture bar code is a special-purpose symbology which delineates a signature capture area in a document with a machine-readable format. The recognition pattern is variable so it can optionally provide an index to various signatures. The region inside the bar code pattern is considered the signature capture area. See [Appendix K, Signature Capture Code](#) for more information.

Scan one of the following bar codes to enable or disable Signature Capture.

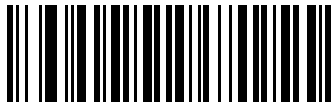

**Enable Signature Capture  
(1)**

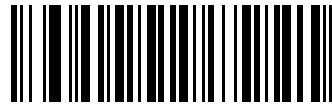

**\*Disable Signature Capture  
(0)**

## Signature Capture File Format Selector

### Parameter # 313

### SSI # F0h 39h

Scan one of the following bar codes to select a signature file format appropriate for the system (BMP, TIFF, or JPEG). The imager stores captured signatures in the selected format.

### Output File Format

Decoding a signature capture bar code de-skews the signature image and converts the image to a BMP, JPEG, or TIFF file format. The output data includes the file descriptor followed by the formatted signature image.

**Table 7-2** *Output File Format*

File Descriptor			Signature Image
Output Format (1 byte)	Signature Type (1 byte)	Signature Image Size (4 bytes) (BIG Endian)	
JPEG - 1 BMP - 3 TIFF - 4	1-8	0x00000400	0x00010203....

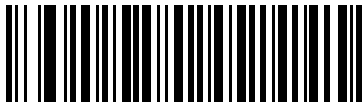

**BMP Signature Format**  
(3)

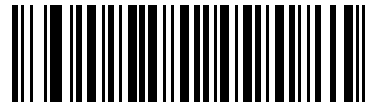

**\*JPEG Signature Format**  
(1)

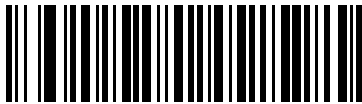

**TIFF Signature Format**  
(4)

## Signature Capture Bits Per Pixel

Parameter # 314

SSI # F0h 3Ah

Scan one of the following bar codes to select the number of significant bits per pixel (BPP) to use when capturing a signature:

- **1 BPP** - For a black and white image.
- **4 BPP** - Assigns 1 of 16 levels of grey to each pixel.
- **8 BPP** - Assigns 1 of 256 levels of grey to each pixel.

✓ **NOTE** The imager ignores these settings for JPEG file formats, which only support **8 BPP**.

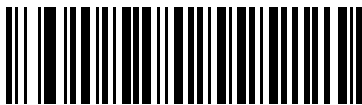

**1 BPP**  
**(0)**



**4 BPP**  
**(1)**

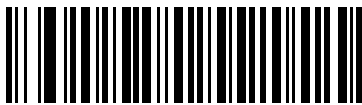

**\*8 BPP**  
**(2)**

## Signature Capture Width

Parameter # 366

SSI # F4h F0h 6Eh

The aspect ratio of the Signature Capture Width and Signature Capture Height parameters must match that of the signature capture area. For example, a 4 x 1 inch signature capture area requires a 4 to 1 aspect ratio of width to height.

To set the width of the signature capture box, scan the **Signature Capture Width** bar code, and then scan four bar codes from [Appendix G, Numeric Bar Codes](#) corresponding to a value in the range of 001 to 640 decimal.



**Signature Capture Width (Default: 400)**  
(001 - 640 Decimal)

## Signature Capture Height

Parameter # 367

SSI # F4h F0h 6Fh

To set the height of the signature capture box, scan the **Signature Capture Height** bar code, and then scan three bar codes from [Appendix G, Numeric Bar Codes](#) corresponding to a value in the range of 001 to 480 decimal.



**Signature Capture Height (Default: 100)**  
(001 - 480 Decimal)

## Signature Capture JPEG Quality

Parameter # 421

SSI # F0h A5h

Scan the **JPEG Quality Value** bar code, and then scan three bar codes from [Appendix G, Numeric Bar Codes](#) corresponding to a value from 005 to 100, where 100 represents the highest quality image.



**JPEG Quality Value (Default: 065)**  
(5 - 100 Decimal)

# CHAPTER 8 USB INTERFACE

---

## Introduction

This chapter describes how to set up the cradle with a USB host. The cradle connects directly to a USB host, or a powered USB hub, which powers it. No additional power supply is required.

The scanner ships with the settings shown in [Table 8-1 on page 8-3](#) (also see [Appendix A, Standard Default Parameters](#) for all defaults). If the default values suit requirements, programming is not necessary.

---

## Setting Parameters

To set feature values, scan a single bar code or a short bar code sequence. The settings are stored in non-volatile memory and are preserved even when the scanner powers down.

✓ **NOTE** Most computer monitors allow scanning bar codes directly on the screen. When scanning from the screen, be sure to set the document magnification to a level where you can see the bar code clearly, and bars and/or spaces do not merge.

To return all features to default values, scan [Set Factory Defaults on page 5-5](#). Throughout the programming bar code menus, asterisks (\*) indicate default values.

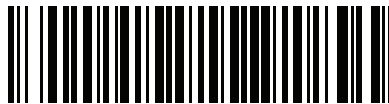

\* Indicates default — **\*Enable Parameter** — Feature/option

## Scanning Sequence Examples

In most cases scanning one bar code sets the parameter value. For example, to set the USB keystroke delay to medium, scan the **Medium Delay (20 msec)** bar code under [USB Keystroke Delay on page 8-8](#). The scanner issues a fast warble beep and the LED turns green, signifying a successful parameter entry.

Other parameters require scanning several bar codes. See the parameter descriptions for this procedure.

## Errors While Scanning

Unless otherwise specified, to correct an error during a scanning sequence, just re-scan the correct parameter.

## Connecting a USB Interface

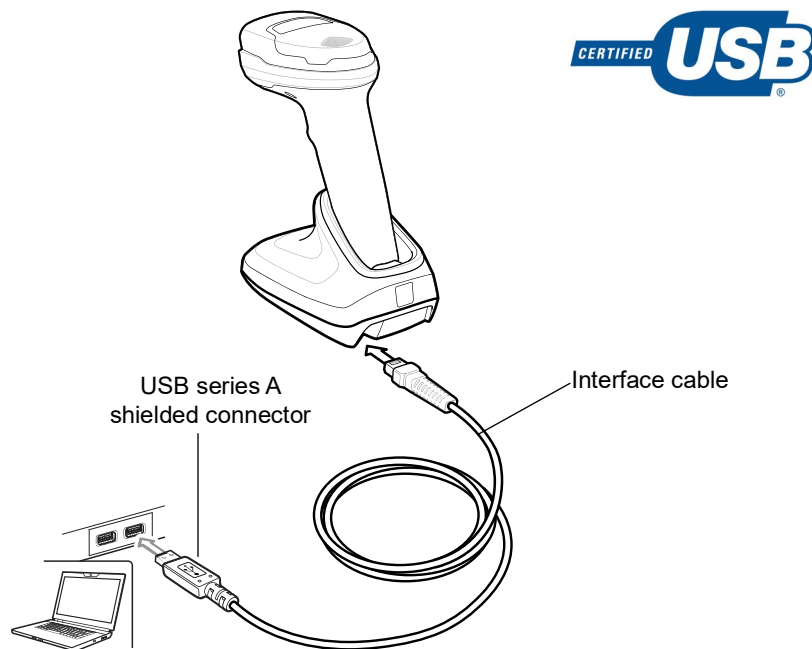

**Figure 8-1** *USB Connection.*

- ✓ **NOTE** If you already have existing non shielded cables from legacy products (such as the LS2208) they can be reused. However, be aware that the shielded cables provide improved ESD performance. For information about cables and cable compatibility, go to the Zebra Partner Portal at: [partnerportal.zebra.com/PartnerPortal/product\\_services/downloads\\_z/barcode\\_scanners/Universal-Cable-Guide-Bar-Code-Scanners.xlsx](https://partnerportal.zebra.com/PartnerPortal/product_services/downloads_z/barcode_scanners/Universal-Cable-Guide-Bar-Code-Scanners.xlsx).

The scanner connects to USB-capable hosts including:

- TGCS (IBM) terminals
- Apple™ desktop and notebooks
- Other network computers that support more than one keyboard.

The following operating systems support the scanner through USB:

- Windows® XP, 7, 8, 10
- MacOS 8.5 - MacOS 10.6
- IBM 4690 OS.

The scanner also interfaces with other USB hosts that support USB Human Interface Devices (HID).

To set up the digital scanner:

✓ **NOTE** Interface cables vary depending on configuration. The connectors illustrated in [Figure 8-1](#) are examples only. The connectors may be different than those illustrated, but the steps to connect the digital scanner are the same.

1. Connect the modular connector of the USB interface cable to the cable interface port on the cradle.
2. Plug the series A connector in the USB host or hub, or plug the Plus Power connector in an available port of the IBM SurePOS terminal.
3. The digital scanner automatically detects the host interface type and uses the default setting. If the default (\*) does not meet your requirements, select another USB device type by scanning the appropriate bar code from [USB Device Type on page 8-5](#).
4. On first installation when using Windows, the software prompts to select or install the Human Interface Device driver. To install this driver, provided by Windows, click **Next** through all the choices and click **Finished** on the last choice. The digital scanner powers up during this installation.
5. To modify any other parameter options, scan the appropriate bar codes in this chapter.

If problems occur with the system, see [Troubleshooting on page 4-3](#).

## USB Parameter Defaults

[Table 8-1](#) lists the defaults for USB host parameters. Change these values in one of two ways:

- Scan the appropriate bar codes in this chapter. The new value replaces the standard default value in memory. To recall default parameter values, see [Default Parameters on page 5-5](#).
- Configure the scanner using the 123Scan configuration program. See [Chapter 2, 123Scan and Software Tools](#).

✓ **NOTE** See [Appendix A, Standard Default Parameters](#) for all user preferences, symbologies, and miscellaneous default parameters.

**Table 8-1** *USB Interface Parameter Defaults*

Parameter	Default	Page Number
<b>USB Host Parameters</b>		
USB Device Type	USB Keyboard HID	<a href="#">8-5</a>
Symbol Native API (SNAPI) Status Handshaking	Enable	<a href="#">8-7</a>
Native Firmware Update	Disable	<a href="#">8-7</a>
USB Keystroke Delay	No Delay	<a href="#">8-8</a>
USB CAPS Lock Override	Disable	<a href="#">8-8</a>
Bar Codes With Unknown Characters	Enable	<a href="#">8-9</a>
USB Convert Unknown to Code 39	Disable	<a href="#">8-9</a>
USB Fast HID	Enable	<a href="#">8-10</a>



**Table 8-1** *USB Interface Parameter Defaults (Continued)*

<b>Parameter</b>	<b>Default</b>	<b>Page Number</b>
USB Polling Interval	3 msec	<a href="#">8-11</a>
Keypad Emulation	Enable	<a href="#">8-13</a>
Quick Keypad Emulation	Enable	<a href="#">8-13</a>
Keypad Emulation with Leading Zero	Enable	<a href="#">8-14</a>
USB Keyboard FN1 Substitution	Disable	<a href="#">8-14</a>
Function Key Mapping	Disable	<a href="#">8-15</a>
Simulated Caps Lock	Disable	<a href="#">8-15</a>
Convert Case	None	<a href="#">8-16</a>
USB Static CDC	Enable	<a href="#">8-16</a>
CDC Beep on <BEL>	Enable	<a href="#">8-17</a>
USB CDC Host Variant	CDC Standard	<a href="#">8-17</a>
TGCS (IBM) USB Direct I/O Beep	Honor	<a href="#">8-19</a>
TGCS (IBM) USB Beep Directive	Ignore	<a href="#">8-20</a>
TGCS (IBM) USB Bar Code Configuration Directive	Ignore	<a href="#">8-20</a>
TGCS (IBM) USB Specification Version	Version 2.2	<a href="#">8-21</a>

---

## USB Host Parameters

### USB Device Type

Scan one of the following bar codes to select the USB device type. To select a country keyboard type for the **USB Keyboard HID** host, see [Appendix B, Country Codes](#).



#### NOTES

1. When changing USB Device Types, the scanner resets and issues the standard startup beep sequences.
2. When connecting two scanners to a host, IBM does not allow selecting two of the same device type. If you require two connections, select IBM Table-Top USB for one scanner and IBM Hand-Held USB for the second scanner.
3. Select **IBM Hand-Held USB** to disable data transmission when an IBM register issues a Scan Disable command. Aim, illumination, and decoding is still permitted. Select **OPOS (IBM Hand-Held with Full Disable)** to completely shut off the scanner when an IBM register issues a Scan Disable command, including aim, illumination, decoding, and data transmission.

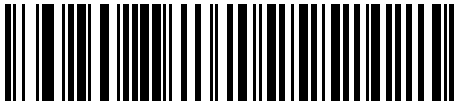

\*USB Keyboard HID



IBM Table-Top USB

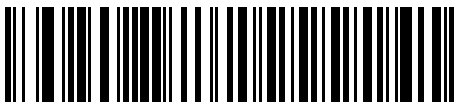

IBM Hand-Held USB



OPOS  
(IBM Hand-Held with Full Disable)

## USB Device Type (continued)



### NOTES

1. Before scanning *USB CDC Host on page 8-6*, install the appropriate USB CDC Driver on the host to ensure the scanner does not stall during power up (due to a failure to enumerate USB). Go to [www.zebra.com/support](http://www.zebra.com/support), Support & Downloads > Barcode Scanners > USB CDC Driver, select the appropriate Windows platform, and download either Zebra\_CDC\_ACM\_Driver\_(x64)v2.15.0004.exe (64 bit) or Zebra\_CDC\_ACM\_Driver(x86)\_v2.15.0004.exe (32 bit).  
To recover a stalled scanner:  
Install the USB CDC Driver  
or  
Unplug the USB cable and then reconnect it to add power back to the scanner. Scan HID Keyboard or another host.  
After power-up, hold the trigger for 10 seconds, which allows the digital scanner to power up using an alternate USB configuration. Upon power-up, scan another **USB Device Type**.
2. To select the Toshiba TEC device type, refer to the *Toshiba TEC Programmer's Guide*.
3. Select USB HID POS to communicate over a USB cable with Universal Windows Platform (UWP) applications running on Windows 10 devices.

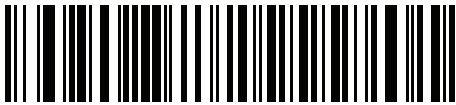

USB CDC Host



SSI over USB CDC

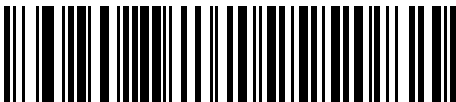

Symbol Native API (SNAPI) with Imaging Interface



Symbol Native API (SNAPI) without Imaging Interface

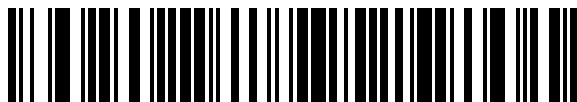

USB HID POS  
(for Windows 10 devices only)

## Symbol Native API (SNAPI) Status Handshaking

After selecting a SNAPI interface as the USB device type, scan one of the following bar codes to select whether to enable or disable status handshaking.



**\*Enable SNAPI Status Handshaking**



**Disable SNAPI Status Handshaking**

## Native Firmware Update

**Parameter # 1727**

**SSI # F8h 06h BFh**

Some scanners that support an auxiliary scanner reboot after setting the secondary USB interface for a native firmware update in the auxiliary scanner. To support previous firmware versions residing in flatbed scanners, this parameter disables the native firmware interface. Changing this parameter requires modifying the USB descriptor, and therefore reboots the device.

Scan **Enable Native Firmware Update** to enable the IBM flash interface.



**Enable Native Firmware Update**



**\*Disable Native Firmware Update**

## USB Keystroke Delay

Scan one of the following bar codes to set the delay, in milliseconds, between emulated keystrokes. Select a longer delay for hosts that require slower data transmission.

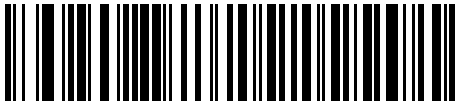

\*No Delay



Medium Delay (20 msec)

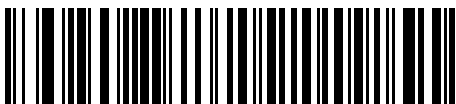

Long Delay (40 msec)

## USB CAPS Lock Override

This option applies only to the USB Keyboard HID device. Scan **Override Caps Lock Key** to preserve the case of the data regardless of the state of the **Caps Lock** key. This setting is always enabled for the Japanese Windows (ASCII) keyboard type and can not be disabled.



Override Caps Lock Key  
(Enable)

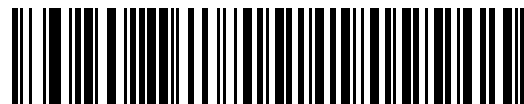

\*Do Not Override Caps Lock Key  
(Disable)

## Bar Codes with Unknown Characters

This option applies only to the USB Keyboard HID and IBM devices. Unknown characters are characters the host does not recognize. Scan **Send Bar Codes With Unknown Characters** to send all bar code data except for unknown characters. The scanner issues no error beeps.

Scan **Do Not Send Bar Codes With Unknown Characters** for IBM devices to prevent sending bar codes containing at least one unknown character to the host, or for USB Keyboard HID devices to send the bar code characters up to the unknown character. The scanner issues an error beep.

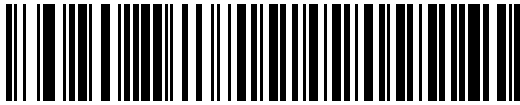

**\*Send Bar Codes with Unknown Characters**



**Do Not Send Bar Codes with Unknown Characters**

## USB Convert Unknown to Code 39

This option applies only to the IBM Hand-Held, IBM Table-Top, and OPOS devices. Scan one of the following bar codes to enable or disable converting unknown bar code type data to Code 39.

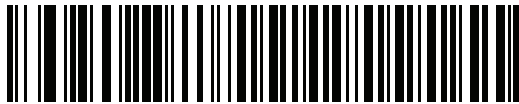

**Enable Convert Unknown to Code 39**



**\*Disable Convert Unknown to Code 39**

## USB Fast HID

Scan **Enable USB Fast HID** to transmit USB HID data at a faster rate.

✓ **NOTE** Disable this if there are problems with transmission.

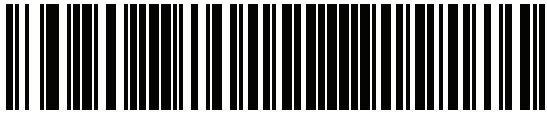

**\*Enable USB Fast HID**

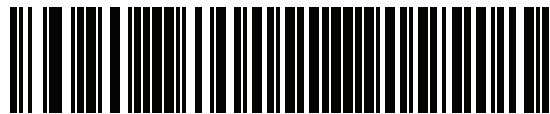

**Disable USB Fast HID**

## USB Polling Interval

Scan one of the following bar codes to set the polling interval, which is the rate at which data transmits between the scanner and host computer. A lower number indicates a faster data rate.



**NOTE** When changing the USB polling interval, the scanner restarts and issues a power-up beep sequence.



**IMPORTANT** Ensure the host supports the selected data rate.

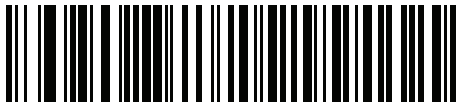

1 msec

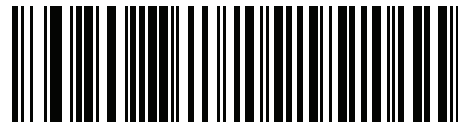

2 msec

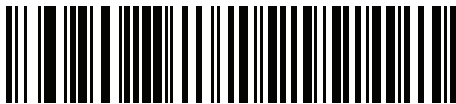

\*3 msec



4 msec

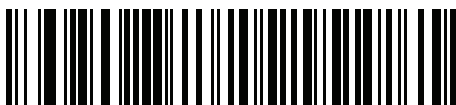

5 msec



### USB Polling Interval (continued)



6 msec



7 msec

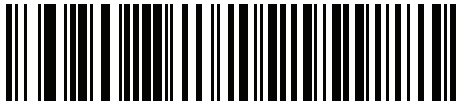

8 msec



9 msec



10 msec

## Keypad Emulation

Scan **Enable Keypad Emulation** to send all characters as ASCII sequences over the numeric keypad. For example, ASCII A transmits as “ALT Make” 0 6 5 “ALT Break”.

✓ **NOTE** If your keyboard type is not listed in the country code list (see *Country Codes on page B-1*), disable [Quick Keypad Emulation on page 8-13](#) and enable **Keypad Emulation**.

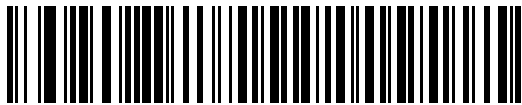

**\*Enable Keypad Emulation**

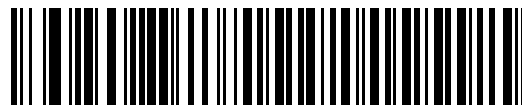

**Disable Keypad Emulation**

## Quick Keypad Emulation

This option applies only to the USB Keyboard HID device when [Keypad Emulation](#) is enabled. Scan **Enable Quick Keypad Emulation** for a quicker method of emulation using the numeric keypad where ASCII sequences are only sent for ASCII characters not found on the keyboard.



**\*Enable Quick Keypad Emulation**



**Disable Quick Keypad Emulation**

## Keypad Emulation with Leading Zero

Scan **Enable Keypad Emulation with Leading Zero** to send character sequences sent over the numeric keypad as ISO characters which have a leading zero. For example, ASCII A transmits as “ALT Make” 0 0 6 5 “ALT Break”.

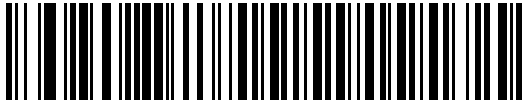

**\*Enable Keypad Emulation with Leading Zero**



**Disable Keypad Emulation with Leading Zero**

## USB Keyboard FN1 Substitution

This option applies only to the USB Keyboard HID device. Scan **Enable USB Keyboard FN1 Substitution** to replace any FN1 character in a GS1 128 bar code with a user-selected Key Category and value. See [FN1 Substitution Values on page 5-36](#) to set the Key Category and Key Value.

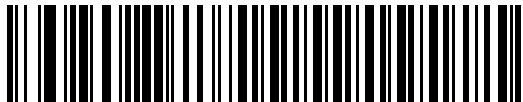

**Enable USB Keyboard FN1 Substitution**



**\*Disable USB Keyboard FN1 Substitution**

## Function Key Mapping

ASCII values under 32 are normally sent as a control-key sequence (see [Table I-1 on page I-1](#)). Scan **Enable Function Key Mapping** to send the keys in bold in place of the standard key mapping. Table entries that do not have a bold equivalent remain the same regardless of whether you enable this parameter.

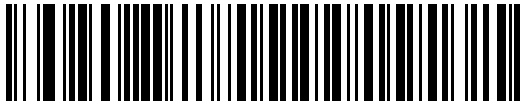

**Enable Function Key Mapping**



**\*Disable Function Key Mapping**

## Simulated Caps Lock

Scan **Enable Simulated Caps Lock** to invert upper and lower case characters on the bar code as if the Caps Lock state is enabled on the keyboard. This inversion occurs regardless of the keyboard's **Caps Lock** state.

- ✓ **NOTE** Simulated Caps Lock applies to ASCII characters only.
- ✓ **NOTE** Do not enable this if [USB CAPS Lock Override on page 8-8](#) is enabled.

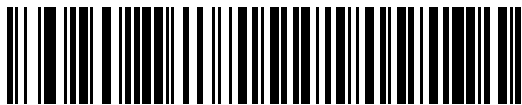

**Enable Simulated Caps Lock**

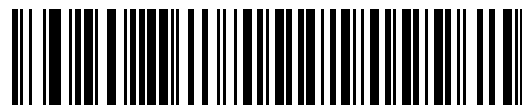

**\*Disable Simulated Caps Lock**

## Convert Case

Scan one of the following bar codes to convert all bar code data to the selected case.

✓ **NOTE** Convert Case applies to ASCII characters only.



**\*No Case Conversion**



**Convert All to Upper Case**



**Convert All to Lower Case**

## USB Static CDC

When disabled, each device connected consumes another COM port (first device = COM1, second device = COM2, third device = COM3, etc.)

When enabled, each device connects to the same COM port.



**\*Enable USB Static CDC**



**Disable USB Static CDC**

## CDC Beep on <BEL>

If you enable this parameter, the scanner issues a beep when it detects a <BEL> character in USB CDC communications. <BEL> indicates an illegal entry or other important event.



\*Enable CDC Beep on <BEL>



Disable CDC Beep on <BEL>

## USB CDC Host Variant

### Parameter # 1713

The USB Airline/Airport (CUTE/CUSS/CUPS) CDC host variant feature mimics the RS-232 host variant (CUTE) feature and is supported over USB CDC host mode. The scanner transmits data in Airline/Airport (CUTE/CUSS/CUPS) data format <Prefix><Data><Suffix>.

The USB Airline/Airport (CUTE/CUSS/CUPS) feature supports two CDC host variants; one for each Independent Software Vendor (ISV) specification (namely, ARINC). The default USB CDC host variant is Standard CDC Host Mode.



\*CDC Standard



CDC ARINC

### Lockout of Parameter Bar Code Scanning

If the scanner is configured as USB CDC Host Variant (other than CDC Standard), it disables all parameter bar code scanning. The user can unlock it by scanning **Enable Parameter Bar Code Scanning** on [page 5-6](#).

### Parameter Default

Enabling of any of the USB CDC Host Variants (other than CDC Standard) requires coercion of other parameters. The scanner updates the parameters in [Table 8-2](#) to the specified default values based on the USB CDC Host Variant selected.

**Table 8-2** Parameter Default for Airport Device Types

Parameter	ARINC Defaults
IATA 2 of 5 (D 2 of 5)	Enabled
Parameter Scanning	Disabled
IATA 2 of 5 (D 2 of 5) lengths	6 to 55
I 2 of 5	Enabled
I 2 of 5 lengths	4 to 56
Micro PDF	N/R
PDF417	Enabled
Code39	Enabled
Code128	Enabled
Triggered Same Symbol Timeout	Enabled
Transmit Code ID	Disabled

## Transmit Data Formatting

### ARINC Format

Data is transmitted in the following format: <STX><DID><DOC><BID><DATA><ETX><CRC>

Where:

<STX> - 0x02

<DID> - 0xB1 (DTYP and DNUM)

<DOC> - 0x30 (Document Identifier)

<BID> - Bar code Identifier ([Table 8-3](#))

<DATA> - Bar code decode data

<ETX> - 0x03

<CRC> - CRC-16

**Table 8-3** ARINC Bar Code Identifier

Bar Code Type	ASCII Value
Interleaved 2 of 5	1
Industrial 2 of 5 (D 2 of 5)	2
Code 39	3
Code 128	5
Code 39 with check digit*	8

\* **Note:** Bar code types with check digits are currently not supported on the scanner for ARINC.

**Table 8-3** ARINC Bar Code Identifier (Continued)

Bar Code Type	ASCII Value
Industrial 2 of 5 with check digit*	9
Interleaved 2 of 5 with check digit*	0
2D Data Matrix	4
2D QR	7
2D PDF	6
EAN 13 with check digit*	A
2D Aztec	8
All others	None

\* **Note:** Bar code types with check digits are currently not supported on the scanner for ARINC.

## TGCS (IBM) USB Direct I/O Beep

The host can send a direct I/O beep request to the scanner. If you select **Ignore Direct I/O Beep**, the scanner does not sound beeps on this command. All directives are still acknowledged to the USB host as if they were processed.

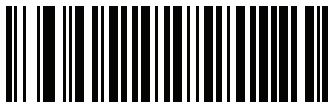

**\*Honor Direct IO Beep**

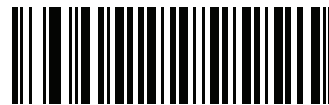

**Ignore Direct IO Beep**



## TGCS (IBM) USB Beep Directive

The host can send a beeper configuration request to the scanner. Scan **Ignore Beep Directive** to prevent the scanner from processing the host request. All directives are still acknowledged to the USB host as if they were processed.

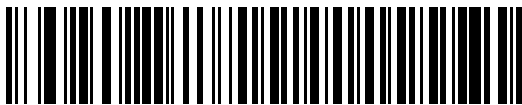

Honor Beep Directive

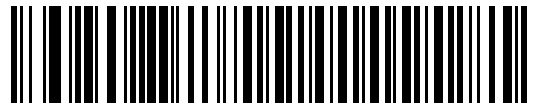

\*Ignore Beep Directive

## TGCS (IBM) USB Bar Code Configuration Directive

The host can enable and disable code types. Scan **Ignore Bar Code Configuration Directive** to prevent the scanner from processing the host request. All directives are still acknowledged to the USB host as if they were processed.



Honor Bar Code Configuration Directive



\*Ignore Bar Code Configuration Directive

## TGCS (IBM) USB Specification Version

Select **IBM Specification Level Version 0 (Original)** to send the following code types as Unknown:

- Data Matrix
- GS1 Data Matrix
- QR Code
- GS1 QR
- MicroQR Code
- Aztec

Select **IBM Specification Level Version 2.2** to send the code types with the appropriate IBM identifiers.



IBM Specification Level Version 0 (Original)



\*IBM Specification Level Version 2.2

---

## ASCII Character Sets for USB

See [Appendix I, ASCII Character Sets](#) for the following:

- ASCII Character Set ([Table I-1 on page I-1](#))
- ALT Key Character Set ([Table I-2 on page I-6](#))
- GUI Key Character Set ([Table I-3 on page I-7](#))
- F Key Character Set ([Table I-5 on page I-10](#)).



# CHAPTER 9 SSI INTERFACE

---

## Introduction

This chapter describes the system requirements of the Simple Serial Interface (SSI), which provides a communications link between Zebra decoders (e.g., scan engines, slot scanners, hand-held scanners, two-dimensional scanners, hands-free scanners, and RF base stations) and a serial host. It provides the means for the host to control the decoder or scanner.

---

## Communication

All communication between the scanner and host occurs over the hardware interface lines using the SSI protocol. Refer to the *Simple Serial Interface Programmer's Guide*, p/n 72E-40451-xx, for more information on SSI.

The host and the scanner exchange messages in packets. A packet is a collection of bytes framed by the proper SSI protocol formatting bytes. The maximum number of bytes per packet that the SSI protocol allows for any transaction is 257 (255 bytes + 2 byte checksum).

Depending on the configuration, the scanner can send decode data as ASCII data (unpacketed), or as part of a larger message (packeted).

SSI performs the following functions for the host device:

- Maintains a bi-directional interface with the scanner
- Allows the host to send commands that control the scanner
- Passes data from the scanner to a host device in SSI packet format or straight decode message.

The SSI environment consists of a scanner, a serial cable which attaches to the host device, and if required, a power supply.

SSI transmits all decode data including special formatting (e.g., AIM ID). Parameter settings can control the format of the transmitted data.

The scanner can also send parameter information, product identification information, or event codes to the host.

All commands sent between the scanner and host must use the format described in the SSI Message Formats section. [SSI Transactions on page 9-3](#) describes the required sequence of messages in specific cases.

*Table 9-1* lists all the SSI opcodes the scanner supports. The host transmits opcodes designated type H. The scanner (decoder) transmits type D opcodes, and either can transmit Host/Decoder (H/D) types.

**Table 9-1** SSI Commands

Name	Type	Opcode	Description
AIM_OFF	H	0xC4	Deactivate aim pattern.
AIM_ON	H	0xC5	Activate aim pattern.
BEEP	H	0xE6	Sound the beeper.
CAPABILITIES_REPLY	D	0xD4	Reply to CAPABILITIES_REQUEST; contains a list of the capabilities and commands the decoder supports.
CAPABILITIES_REQUEST	H	0xD3	Request capabilities report from the decoder.
CMD_ACK	H/D	0xD0	Positive acknowledgment of received packet.
CMD_NAK	H/D	0xD1	Negative acknowledgment of received packet.
DECODE_DATA	D	0xF3	Decode data in SSI packet format.
EVENT	D	0xF6	Event indicated by associated event code.
LED_OFF	H	0xE8	De-activate LED output.
LED_ON	H	0xE7	Activate LED output.
PARAM_DEFAULTS	H	0xC8	Set parameter default values.
PARAM_REQUEST	H	0xC7	Request values of certain parameters.
PARAM_SEND	H/D	0xC6	Send parameter values.
REPLY_REVISION	D	0xA4	Reply to REQUEST_REVISION, contains the decoder's software/hardware configuration.
REQUEST_REVISION	H	0xA3	Request the decoder's configuration.
SCAN_DISABLE	H	0xEA	Prevent the operator from scanning bar codes.
SCAN_ENABLE	H	0xE9	Permit bar code scanning.
SLEEP	H	0xEB	Request to place the decoder into low power.
START_DECODE	H	0xE4	Tell the decoder to attempt to decode a bar code.
STOP_DECODE	H	0xE5	Tell the decoder to abort a decode attempt.
WAKEUP	H	N/A	Wake the decoder from low power mode.

For details of the SSI protocol, refer to the *Simple Serial Interface Programmer's Guide*.

---

## SSI Transactions

### General Data Transactions

#### ACK/NAK Handshaking

If you enable ACK/NAK handshaking (the default), all packeted messages must have a CMD\_ACK or CMD\_NAK response, unless the command description states otherwise. Zebra recommends leaving this handshaking enabled to provide feedback to the host. Raw decode data and WAKEUP do not use ACK/NAK handshaking since they are not packeted data.

Following is an example of a problem which can occur if you disable ACK/NAK handshaking:

- The host sends a PARAM\_SEND message to the scanner to change the baud rate from 9600 to 19200.
- The scanner cannot interpret the message.
- The scanner does not implement the change the host requested.
- The host assumes that the parameter change occurred and acts accordingly.
- Communication is lost because the change did not occur on both sides.

If you enable ACK/NAK handshaking, the following occurs:

- The host sends a PARAM\_SEND message.
- The scanner cannot interpret the message.
- The scanner CMD\_NAKs the message.
- The host resends the message.
- The scanner receives the message successfully, responds with CMD\_ACK, and implements parameter changes.

## Decoded Data Transmission

The *Decode Data Packet Format* parameter controls how decode data is sent to the host. Set this parameter to send the data in a DECODE\_DATA packet. Clear this parameter to transmit the data as raw ASCII data.

✓ **NOTE** When transmitting decode data as raw ASCII data, ACK/NAK handshaking does not apply regardless of the state of the ACK/NAK handshaking parameter.

### ACK/NAK Enabled and Packeted Data

The scanner sends a DECODE\_DATA message after a successful decode. The scanner waits for a programmable timeout for a CMD\_ACK response. If it does not receive the response, the scanner tries to send two more times before issuing a host transmission error. If the scanner receives a CMD\_NAK from the host, it may attempt a retry depending on the cause field of the CMD\_NAK message.

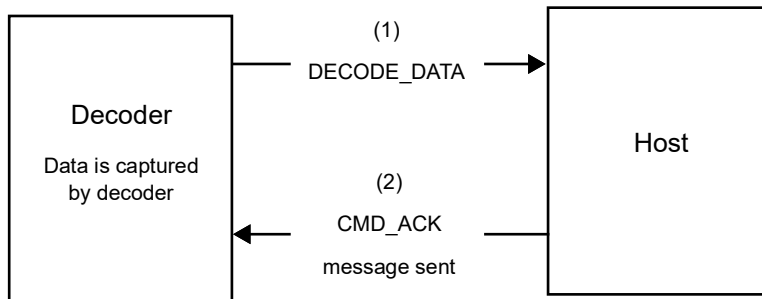

### ACK/NAK Enabled and Unpacketed ASCII Data

Even if ACK/NAK handshaking is enabled, no handshaking occurs because handshaking applies only to packeted data. In this example the packeted\_decode parameter is disabled.

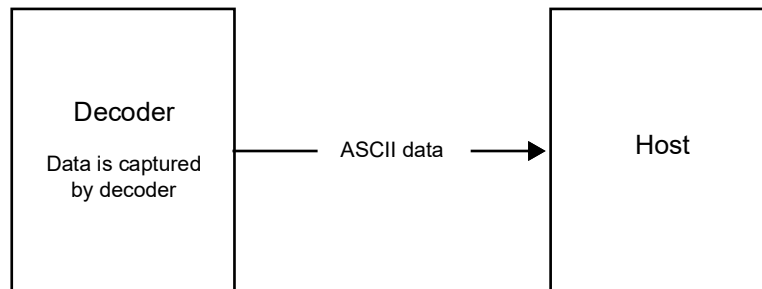

### ACK/NAK Disabled and Packeted DECODE\_DATA

In this example ACK/NAK does not occur even though packeted\_decode is enabled because the ACK/NAK handshaking parameter is disabled.

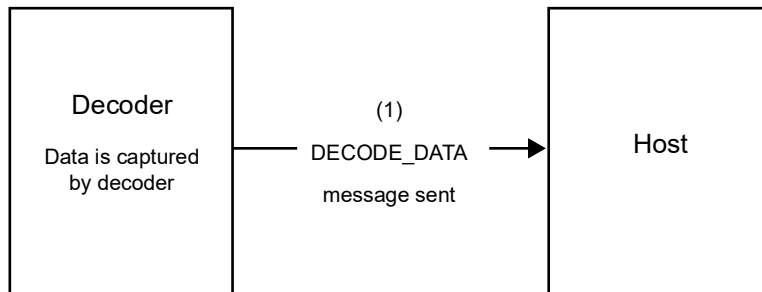

### ACK/NAK Disabled and Unpacketed ASCII Data

The decoder sends captured data to the host.

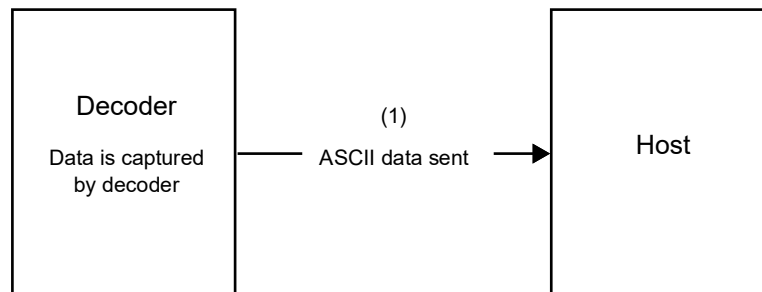



---

## Communication Summary

### RTS/CTS Lines

All communication must use RTS/CTS handshaking as described in the *Simple Serial Interface Programmer's Guide*, p/n 72E-40451-xx. If bypassing hardware handshaking, the host must send the WAKEUP command before all other communication or the first byte of a message can be lost during the scanner wakeup sequence. Zebra recommends not bypassing RTS/CTS hardware handshaking.

### ACK/NAK Option

ACK/NAK handshaking is enabled by default and Zebra recommends leaving it enabled. Disabling this can cause communication problems, as handshaking is the only acknowledgment that a message was received correctly. ACK/NAK is not used with unpacked decode data regardless of whether it is enabled.

### Number of Data Bits

All communication with the scanner must use 8-bit data.

### Serial Response Timeout

The *Host Serial Response Timeout* parameter determines how long to wait for a handshaking response before trying again or aborting further attempts. Set the same value for both the host and scanner.

- ✓ **NOTE** You can temporarily change the *Host Serial Response Timeout* when the host takes longer to process an ACK or longer data string. Zebra does not recommend frequent permanent changes due to limited write cycles of non-volatile memory.

### Retries

The host resends data twice after the initial send if the scanner does not respond with an ACK or NAK (if ACK/NAK handshaking is enabled), or response data (e.g., PARAM\_SEND, REPLY\_REVISION). If the scanner replies with a NAK RESEND, the host resends the data. All resent messages must have the resend bit set in the Status byte.

The scanner resends data two times after the initial send if the host fails to reply with an ACK or NAK (if ACK/NAK handshaking is enabled).

### Baud Rate, Stop Bits, Parity, Response Timeout, ACK/NAK Handshaking

If you use PARAM\_SEND to change these serial parameters, the ACK response to the PARAM\_SEND uses the previous values for these parameters. The new values then take effect for the next transaction.

### Errors

The scanner issues a communication error when:

- The CTS line is asserted when the scanner tries to transmit, and is still asserted on each of two successive retries
- The scanner does not receive an ACK or NAK after initial transmit and two resends.

## SSI Communication Notes

- When not using hardware handshaking, space messages sufficiently apart. The host must not communicate with the scanner if the scanner is transmitting.
- When using hardware handshaking, frame each message properly with handshaking signals. Do not try to send two commands within the same handshaking frame.
- There is a permanent/temporary bit in the PARAM\_SEND message. Removing power from the scanner discards temporary changes. Permanent changes are written to non-volatile memory. Frequent changes shorten the life of the non-volatile memory.

## Using Time Delay to Low Power Mode with SSI

[Time Delay to Low Power Mode on page 5-12](#) provides options to select a general time delay. To program a more specific delay value, use an SSI command according to [Table 9-2](#).

**Table 9-2** Values for Selecting Time Delay to Low Power

Value	Timeout	Value	Timeout	Value	Timeout	Value	Timeout
0x00	15 Min	0x10	1 Sec	0x20	1 Min	0x30	1 Hour
0x01	30 Min	0x11	1 Sec	0x21	1 Min	0x31	1 Hour
0x02	60 Min	0x12	2 Sec	0x22	2 Min	0x32	2 Hours
0x03	90 Min	0x13	3 Sec	0x23	3 Min	0x33	3 Hours
N/A	N/A	0x14	4 Sec	0x24	4 Min	0x34	4 Hours
N/A	N/A	0x15	5 Sec	0x25	5 Min	0x35	5 Hours
N/A	N/A	0x16	6 Sec	0x26	6 Min	0x36	6 Hours
N/A	N/A	0x17	7 Sec	0x27	7 Min	0x37	7 Hours
N/A	N/A	0x18	8 Sec	0x28	8 Min	0x38	8 Hours
N/A	N/A	0x19	9 Sec	0x29	9 Min	0x39	9 Hours
N/A	N/A	0x1A	10 Sec	0x2A	10 Min	0x3A	10 Hours
N/A	N/A	0x1B	15 Sec	0x2B	15 Min	0x3B	15 Hours
N/A	N/A	0x1C	20 Sec	0x2C	20 Min	0x3C	20 Hours
N/A	N/A	0x1D	30 Sec	0x2D	30 Min	0x3D	30 Hours
N/A	N/A	0x1E	45 Sec	0x2E	45 Min	0x3E	45 Hours
N/A	N/A	0x1F	60 Sec	0x2F	60 Min	0x3F	60 Hours



**CAUTION** With hardware handshaking disabled, the scanner wakes from low power mode upon receiving a character. However, the scanner does not process this character or any others it receives during the 7 ms period following wakeup. Wait at least 7 ms after wakeup to send valid characters.

## Encapsulation of RSM Commands/Responses over SSI

The SSI protocol allows the host to send a command that is variable in length up to 255 bytes. Although there is a provision in the protocol to multi-packet commands from the host, the scanner does not support this. The host must fragment packets using the provisions in the RSM protocol.

### Command Structure

Byte	7	6	5	4	3	2	1	0
0	Length (not including the checksum)							
1	SSI_MGMT_COMMAND (0x80)							
2	Message Source (4 - Host)							
3	Reserved (0)			Reserved (0)		Reserved (0)	Cont'd packet	Retransmit
4	Payload data (see the following example)							
...								
Length -1								
Length	2's complement checksum (MSB)							
Length +1	2's complement checksum (LSB)							

The expected positive response is SSI\_MGMT\_COMMAND which can be a multi-packet response. Devices that do not support this command respond with the standard SSI\_NAK.

### Response Structure

Byte	7	6	5	4	3	2	1	0
0	Length (not including the checksum)							
1	SSI_MGMT_COMMAND (0x80)							
2	Message Source (0 - Decoder)							
3	Reserved (0)			Reserved (0)		Reserved (0)	Cont'd packet	Retransmit
4	Payload data (see the following example)							
...								
Length -1								
Length	2's complement checksum (MSB)							
Length +1	2's complement checksum (LSB)							

## Example Transaction

The following example illustrates how to retrieve diagnostic information (Diagnostic Testing and Reporting (Attribute #10061) decimal) from the scanner using encapsulation of RSM commands over SSI. Before sending an RSM command, the host must send the RSM Get Packet Size command to query the packet size supported by the device.

### Command from Host to Query Packet Size Supported by Device

```
0A 80 04 00 00 06 20 00 FF FF FD 4E
```

Where:

- 0A 80 04 00 is encapsulation of RSM commands over SSI command header
- 00 06 20 00 FF FF is RSM Get Packet Size command
- FD 4E is SSI command checksum

### Response from Device with Packet Size Information

```
0C 80 00 00 00 08 20 00 00 F0 00 F0 FD 6C
```

Where:

- 0C 80 00 00 is encapsulation of RSM command over SSI command header
- 00 08 20 00 00 F0 00 F0 is RSM Get Packet Size response
- FD 6C is SSI response checksum

### Command from Host to Retrieve Diagnostic Information

```
0C 80 04 00 00 08 02 00 27 4D 42 00 FE B0
```

Where:

- 0C 80 04 00 is encapsulation of RSM commands over SSI command header
- 00 08 02 00 27 4D 42 00 is attribute Get command requesting attribute 10061 decimal
- FE B0 is SSI command checksum

### Response from Device with Diagnostic Information

```
21 80 00 00 00 1D 02 00 27 4D 41 01 42 00 0E 00 00 00 00 01 03 02 03 03 03 04 03 05 03 06 03 FF FF FC 15
```

Where:

- 21 80 00 00 00 1D 02 00 27 4D 41 01 42 00 0E 00 00 is encapsulation of RSM responses over SSI command header
- 00 00 01 03 02 03 03 03 04 03 05 03 06 03 is attribute Get response which includes diagnostic report value
- FF FF is attribute Get response, packet termination
- FC 15 is SSI response checksum

## Setting Parameters

This section describes how to set up the scanner with an SSI host. When using SSI, program the scanner via bar code menu or SSI hosts commands.

The scanner ships with the settings shown in [Table 9-3 on page 9-11](#) (also see [Appendix A, Standard Default Parameters](#) for all defaults). If the default values suit requirements, programming is not necessary.

To set feature values, scan a single bar code or a short bar code sequence. The settings are stored in non-volatile memory and are preserved even when the scanner powers down.

✓ **NOTE** Most computer monitors allow scanning bar codes directly on the screen. When scanning from the screen, be sure to set the document magnification to a level where you can see the bar code clearly, and bars and/or spaces do not merge.

To return all features to default values, scan [Set Factory Defaults on page 5-5](#). Throughout the programming bar code menus, asterisks (\*) indicate default values.

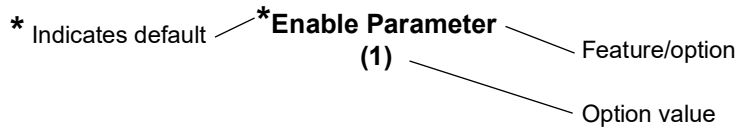

## Scanning Sequence Examples

In most cases scanning one bar code sets the parameter value. For example, to set the baud rate to 19,200, scan the **Baud Rate 19,200** bar code under [Baud Rate on page 9-12](#). The scanner issues a fast warble beep and the LED turns green, signifying a successful parameter entry.

Other parameters require scanning several bar codes. See the parameter descriptions for this procedure.

## Errors While Scanning

Unless otherwise specified, to correct an error during a scanning sequence, just re-scan the correct parameter.

## Simple Serial Interface Parameter Defaults

[Table 9-1](#) lists defaults for SSI host parameters. Change these values in one of two ways:

- Scan the appropriate bar codes in this chapter. The new value replaces the standard default value in memory. To recall default parameter values, see [Default Parameters on page 5-5](#).
- Download data through the device's serial port using SSI. Hexadecimal parameter numbers appear in this chapter below the parameter title, and option values appear in parenthesis beneath the accompanying bar codes. Refer to the *Simple Serial Interface (SSI) Programmer's Guide* for detailed instructions for changing parameters using this method.

✓ **NOTE** See [Appendix A, Standard Default Parameters](#) for all user preference, host, symbology, and miscellaneous default parameters.

**Table 9-3** SSI Interface Default Table

Parameter	Parameter Number	SSI Number	Default	Page Number
<b>SSI Host Parameters</b>				
Select SSI Host	N/A	N/A	N/A	<a href="#">9-12</a>
Baud Rate	156	9Ch	9600	<a href="#">9-12</a>
Parity	158	9Eh	None	<a href="#">9-14</a>
Check Parity	151	97h	Disable	<a href="#">9-15</a>
Stop Bits	157	9Dh	1	<a href="#">9-15</a>
Software Handshaking	159	9Fh	ACK/NAK	<a href="#">9-16</a>
Host RTS Line State	154	9Ah	Low	<a href="#">9-17</a>
Decode Data Packet Format	238	EEh	Send Raw Decode Data	<a href="#">9-17</a>
Host Serial Response Timeout	155	9Bh	2 Seconds	<a href="#">9-18</a>
Host Character Timeout	239	EFh	200 msec	<a href="#">9-19</a>
Multipacket Option	334	F0h 4Eh	Option 1	<a href="#">9-20</a>
Interpacket Delay	335	F0h 4Fh	0 msec	<a href="#">9-21</a>
<b>Event Reporting</b>				
Decode Event	256	F0h 00h	Disable	<a href="#">9-22</a>
Boot Up Event	258	F0h 02h	Disable	<a href="#">9-23</a>
Parameter Event	259	F0h 03h	Disable	<a href="#">9-23</a>

✓ **NOTE** SSI interprets Prefix, Suffix1, and Suffix2 values listed in [Table I-1 on page I-1](#) differently than other interfaces. SSI does not recognize key categories, only the 3-digit decimal value. The default value of 7013 is interpreted as CR only.

---

## SSI Host Parameters

### Select SSI Host

To select SSI as the host interface, scan the following bar code.

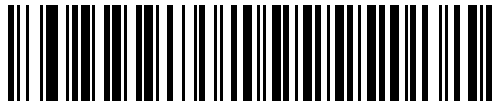

**SSI Host**

### Baud Rate

#### Parameter # 156

#### SSI # 9Ch

Baud rate is the number of bits of data transmitted per second. Scan one of the following bar codes to set the scanner's baud rate to match the baud rate setting of the host device. Otherwise, data may not reach the host device or may reach it in distorted form.

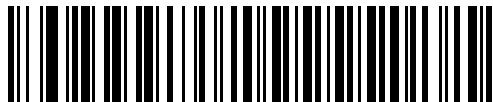

**\*Baud Rate 9600  
(6)**



**Baud Rate 19,200  
(7)**



**Baud Rate 38,400  
(8)**



**Baud Rate 57,600  
(10)**

**Baud Rate (continued)**



**Baud Rate 115,200  
(11)**

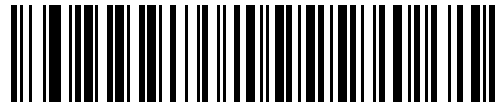

**Baud Rate 230,400  
(13)**

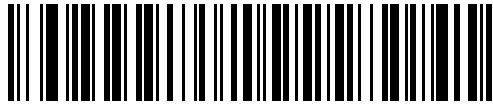

**Baud Rate 460,800  
(14)**

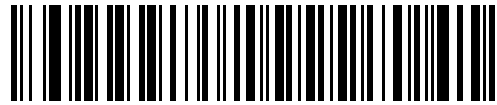

**Baud Rate 921,600  
(15)**



## Parity

### Parameter # 158

### SSI # 9Eh

A parity check bit is the most significant bit of each ASCII coded character. Scan one of the following bar codes to select the parity type according to host device requirements:

- **Odd** - This sets the parity bit value to 0 or 1, based on data, to ensure that the coded character contains an odd number of 1 bits.
- **Even** - This sets the parity bit value to 0 or 1, based on data, to ensure that the coded character contains an even number of 1 bits.
- **None** - No parity bit is required.

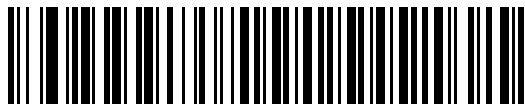

**Odd  
(2)**

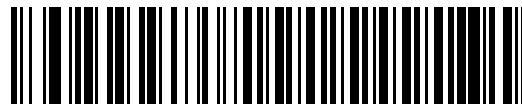

**Even  
(1)**

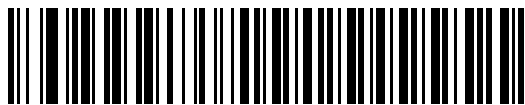

**\*None  
(0)**

## Check Parity

Parameter # 151

SSI # 97h

Scan one of the following bar codes to select whether to check the parity of received characters. See [Parity](#) to select the type of parity.

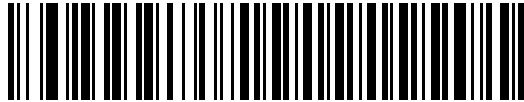

**\*Do Not Check Parity  
(0)**

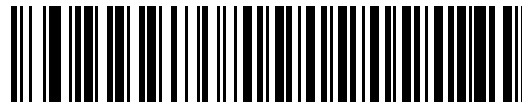

**Check Parity  
(1)**

## Stop Bits

Parameter # 157

SSI # 9Dh

The stop bit(s) at the end of each transmitted character marks the end of transmission of one character and prepares the receiving device for the next character in the serial data stream. Scan one of the following bar codes to set the number of stop bits (one or two) based on the number the receiving host can accommodate.

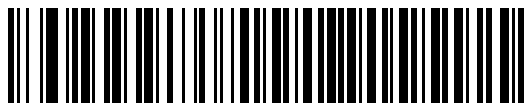

**\*1 Stop Bit  
(1)**

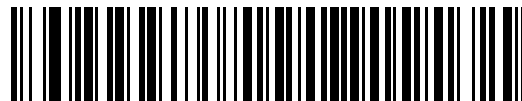

**2 Stop Bits  
(2)**

## Software Handshaking

**Parameter # 159**

**SSI # 9Fh**

This parameter offers control of data transmission in addition to the control hardware handshaking offers. Hardware handshaking is always enabled; you cannot disable it.

Options:

- **Disable ACK/NAK Handshaking** - The scanner neither generates nor expects ACK/NAK handshaking packets.
- **Enable ACK/NAK Handshaking** - After transmitting data, the scanner expects either an ACK or NAK response from the host. The scanner also ACKs or NAKs messages from the host.

The scanner waits up to the programmable *Host Serial Response Timeout* to receive an ACK or NAK. If the scanner does not get a response in this time, it resends its data up to two times before discarding the data and declaring a transmission error.

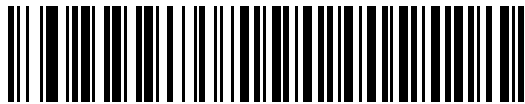

**Disable ACK/NAK**  
**(0)**

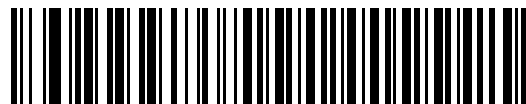

**\*Enable ACK/NAK**  
**(1)**

## Host RTS Line State

Parameter # 154

SSI # 9Ah

Scan one of the following bar codes to set the expected idle state of the Serial Host RTS line.

The SSI interface is used with host applications which also implement the SSI protocol. However, you can use the scanner in a "scan-and-transmit" mode to communicate with any standard serial communication software on a host PC (see [Decode Data Packet Format on page 9-17](#)). If transmission errors occur in this mode, the host PC may be asserting hardware handshaking lines which interfere with the SSI protocol. Scan the **High** bar code to address this problem.

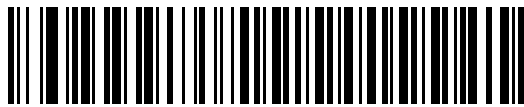

\*Low  
(0)



High  
(1)

## Decode Data Packet Format

Parameter # 238

SSI # EEh

Scan one of the following bar codes to select whether to transmit decoded data in raw format (unpacketed), or with the packet format defined by the serial protocol.

Selecting the raw format disables ACK/NAK handshaking for decode data.

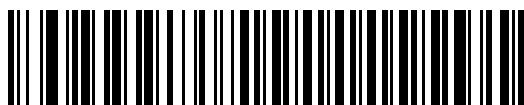

\*Send Raw Decode Data  
(0)



Send Packeted Decode Data  
(1)

## Host Serial Response Timeout

Parameter # 155

SSI # 9Bh

Scan one of the following bar codes to specify how long the scanner waits for an ACK or NAK before resending. Also, if the scanner wants to send, and the host has already been granted permission to send, the scanner waits for the designated timeout before declaring an error.

✓ **NOTE** Other values are available via SSI command.

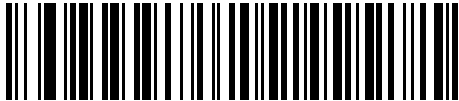

**\*Low - 2 Seconds  
(20)**

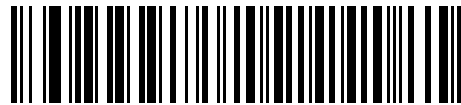

**Medium - 5 Seconds  
(50)**



**High - 7.5 Seconds  
(75)**

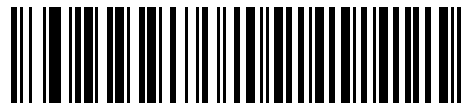

**Maximum - 9.9 Seconds  
(99)**

## Host Character Timeout

### Parameter # 239

#### SSI # EFh

Scan one of the following bar codes to specify the maximum time the scanner waits between characters transmitted by the host before discarding the received data and declaring an error.

✓ **NOTE** Other values are available via SSI command.



**\*Low - 200 msec  
(20)**



**Medium - 500 msec  
(50)**

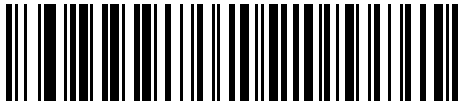

**High - 750 msec  
(75)**

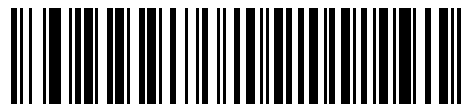

**Maximum - 990 msec  
(99)**

## Multipacket Option

Parameter # 334

SSI # F0h 4Eh

Scan one of the following bar codes to control ACK/NAK handshaking for multi-packet transmissions:

- **Multi-Packet Option 1** - The host sends an ACK/NAK for each data packet during a multi-packet transmission.
- **Multi-Packet Option 2** - The scanner sends data packets continuously, with no ACK/NAK handshaking to pace the transmission. The host, if overrun, can use hardware handshaking to temporarily delay scanner transmissions. At the end of transmission, the scanner waits for a CMD\_ACK or CMD\_NAK.
- **Multi-Packet Option 3** - This is the same as option 2 with the addition of a programmable interpacket delay. See [Interpacket Delay on page 9-21](#) to set this delay.



**\*Multipacket Option 1  
(0)**

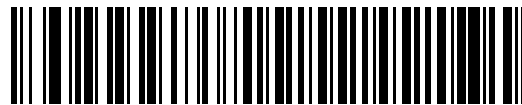

**Multipacket Option 2  
(1)**



**Multipacket Option 3  
(2)**

## Interpacket Delay

Parameter # 335

SSI # F0h 4Fh

Scan one of the following bar codes to specify the interpacket delay if you selected **Multipacket Option 3**.

✓ **NOTE** Other values are available via SSI command.

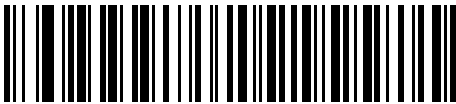

\*Minimum - 0 msec  
(0)



Low - 25 msec  
(25)

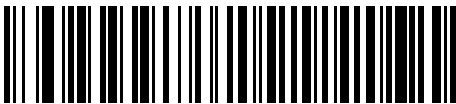

Medium - 50 msec  
(50)

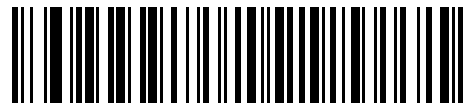

High - 75 msec  
(75)

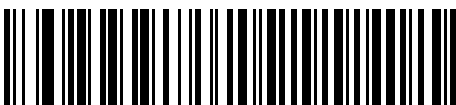

Maximum - 99 msec  
(99)



## Event Reporting

The host can request the scanner to provide certain information (events) relative to scanner behavior. Scan the following bar codes to enable or disable the events listed in [Table 9-4](#) and on the following pages.

**Table 9-4** *Event Codes*

Event Class	Event	Code Reported
Decode Event	Non-parameter decode	0x01
Boot Up Event	System power-up	0x03
Parameter Event	Parameter entry error	0x07
	Parameter stored	0x08
	Defaults set (and parameter event is enabled by default)	0x0A
	Number expected	0x0F

### Decode Event

**Parameter # 256**

**SSI # F0h 00h**

Scan one of the following bar codes to enable or disable Decode Event.

- **Enable Decode Event** - The scanner generates a message to the host upon a successful bar code decode.
- **Disable Decode Event** - No notification is sent.

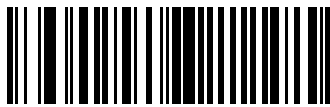

**Enable Decode Event  
(1)**

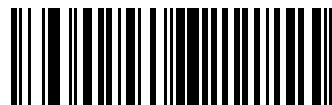

**\*Disable Decode Event  
(0)**

## Boot Up Event

Parameter # 258

SSI # F0h 02h

Scan one of the following bar codes to enable or disable Boot Up Event:

- **Enable Boot Up Event** - The scanner generates a message to the host whenever power is applied.
- **Disable Boot Up Event** - No notification is sent.

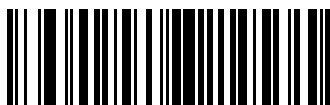

Enable Boot Up Event  
(1)



\*Disable Boot Up Event  
(0)

## Parameter Event

Parameter # 259

SSI # F0h 03h

Scan one of the following bar codes to enable or disable Parameter Event:

- **Enable Parameter Event** - The scanner generates a message to the host when one of the events specified in [Table 9-4 on page 9-22](#) occurs.
- **Disable Parameter Event** - No notification is sent.

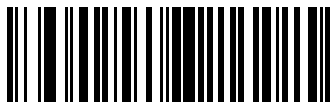

Enable Parameter Event  
(1)



\*Disable Parameter Event  
(0)



# CHAPTER 10 RS-232 INTERFACE

---

## Introduction

This chapter describes how to set up the cradle with an RS-232 host. The cradle can use the RS-232 interface to connect to point-of-sale devices, host computers, or other devices with an available RS-232 port (e.g., com port).

The scanner ships with the settings shown in [Table 10-1 on page 10-3](#) (also see [Appendix A, Standard Default Parameters](#) for all defaults). If the default values suit requirements, programming is not necessary.

If your host does not appear in [Table 10-2](#), refer to the documentation for the host device to set communication parameters to match the host.

- ✓ **NOTE** The scanner uses TTL RS-232 signal levels, which interface with most system architectures. For system architectures requiring RS-232C signal levels, Zebra offers different cables providing TTL-to-RS-232C conversion. Contact the Zebra Support & Downloads website for more information.

---

## Setting Parameters

To set feature values, scan a single bar code or a short bar code sequence. The settings are stored in non-volatile memory and are preserved even when the scanner powers down.

- ✓ **NOTE** Most computer monitors allow scanning bar codes directly on the screen. When scanning from the screen, be sure to set the document magnification to a level where you can see the bar code clearly, and bars and/or spaces do not merge.

To return all features to default values, scan [Set Factory Defaults on page 5-5](#). Throughout the programming bar code menus, asterisks (\*) indicate default values.



\* Indicates default      \*Enable Parameter      Feature/option

## Scanning Sequence Examples

In most cases scanning one bar code sets the parameter value. For example, to set the baud rate to 19,200, scan the **Baud Rate 19,200** bar code under *Baud Rate on page 10-8*. The scanner issues a fast warble beep and the LED turns green, signifying a successful parameter entry.

Other parameters require scanning several bar codes. See the parameter descriptions for this procedure.

## Errors While Scanning

Unless otherwise specified, to correct an error during a scanning sequence, just re-scan the correct parameter.

---

## Connecting an RS-232 Interface

Connect the scanner directly to the host computer.

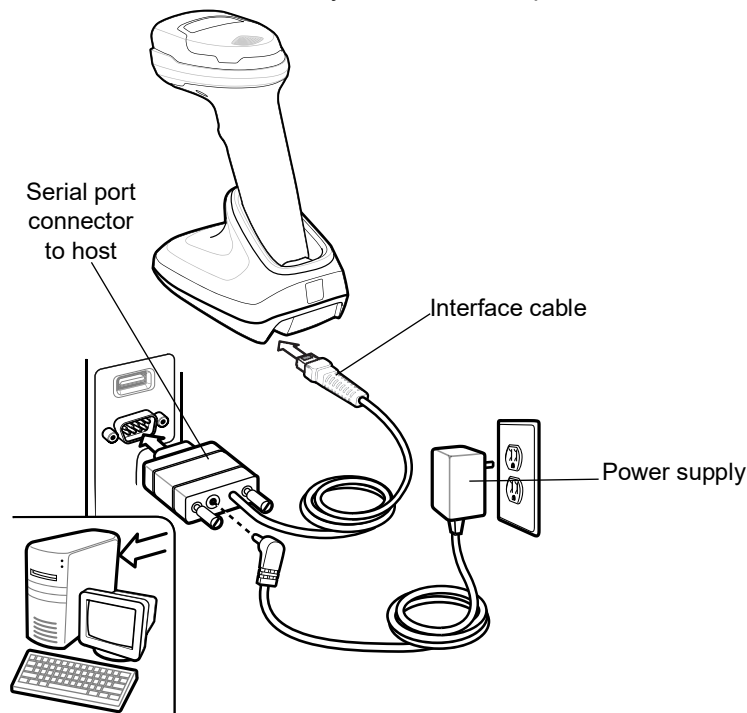

**Figure 10-1** *RS-232 Connection*

✓ **NOTE** Interface cables vary depending on configuration. The connectors can be different than those illustrated in *Figure 10-1*, but the steps to connect the scanner are the same.

1. Attach the modular connector of the RS-232 interface cable to the cable interface port on the cradle.
2. Connect the other end of the RS-232 interface cable to the serial port on the host.
3. If required, connect the power supply to the serial connector end of the RS-232 interface cable. Plug the power supply into an appropriate outlet.

4. The scanner automatically detects the host interface type and uses the default setting. If the default (\*) does not meet your requirements, select another RS-232 host type by scanning the appropriate bar code from [RS-232 Host Types on page 10-6](#).
5. To modify any other parameter options, scan the appropriate bar codes in this chapter.

If problems occur with the system, see [Troubleshooting on page 4-3](#).

## RS-232 Parameter Defaults

[Table 10-1](#) lists defaults for RS-232 host parameters. Change these values in one of two ways:

- Scan the appropriate bar codes in this chapter. The new value replaces the standard default value in memory. To recall default parameter values, see [Default Parameters on page 5-5](#).
- Configure the scanner using the 123Scan configuration program. See [Chapter 2, 123Scan and Software Tools](#).

✓ **NOTE** See [Appendix A, Standard Default Parameters](#) for all user preference, host, symbology, and miscellaneous default parameters.

**Table 10-1** RS-232 Interface Parameter Defaults

Parameter	Default	Page Number
<b>RS-232 Host Parameters</b>		
RS-232 Host Types	Standard	<a href="#">10-6</a>
Baud Rate	9600	<a href="#">10-8</a>
Parity	None	<a href="#">10-9</a>
Stop Bits	1 Stop Bit	<a href="#">10-9</a>
Data Bits	8-bit	<a href="#">10-10</a>
Check Receive Errors	Enable	<a href="#">10-10</a>
Hardware Handshaking	None	<a href="#">10-11</a>
Software Handshaking	None	<a href="#">10-13</a>
Host Serial Response Timeout	2 Sec	<a href="#">10-15</a>
RTS Line State	Low RTS	<a href="#">10-16</a>
Beep on <BEL>	Disable	<a href="#">10-16</a>
Intercharacter Delay	0 msec	<a href="#">10-17</a>
Nixdorf Beep/LED Options	Normal Operation	<a href="#">10-18</a>
Bar Codes with Unknown Characters	Send Bar Code With Unknown Characters	<a href="#">10-18</a>

## RS-232 Host Parameters

Various RS-232 hosts use their own parameter default settings. Selecting standard, ICL, Fujitsu, Wincor-Nixdorf Mode A, Wincor-Nixdorf Mode B, OPOS/JPOS, Olivetti, Omron, or Common Use Terminal Equipment (CUTE-LP/LG bar code readers) sets the defaults listed in [Table 10-2](#).

**Table 10-2** Terminal Specific RS-232

Parameter	ICL	Fujitsu	Wincor-Nixdorf Mode A	Wincor-Nixdorf Mode B/OPOS/JPOS	Olivetti	Omron	CUTE
Transmit Code ID	Yes	Yes	Yes	Yes	Yes	Yes	Yes
Data Transmission Format	Data/Suffix	Data/Suffix	Data/Suffix	Data/Suffix	Prefix/Data/Suffix	Data/Suffix	Prefix/Data/Suffix
Suffix	CR (1013)	CR (1013)	CR (1013)	CR (1013)	ETX (1002)	CR (1013)	CR (1013) ETX (1003)
Baud Rate	9600	9600	9600	9600	9600	9600	9600
Parity	Even	None	Odd	Odd	Even	None	Even
Hardware Handshaking	RTS/CTS Option 3	None	RTS/CTS Option 3	RTS/CTS Option 3	None	None	None
Software Handshaking	None	None	None	None	ACK/NAK	None	None
Serial Response Timeout	9.9 Sec.	2 Sec.	None	None	9.9 Sec.	9.9 Sec.	9.9 Sec.
Stop Bit Select	One	One	One	One	One	One	One
ASCII Format	8-Bit	8-Bit	8-Bit	8-Bit	7-Bit	8-Bit	7-Bit
Beep On <BEL>	Disable	Disable	Disable	Disable	Disable	Disable	Disable
RTS Line State	High	Low	Low	Low = No data to send	Low	High	High
Prefix	None	None	None	None	STX (1003)	None	STX (1002)

**In the Wincor-Nixdorf Mode A/B, if CTS is low, scanning is disabled. When CTS is high, scanning is enabled. If you scan Wincor-Nixdorf RS-232 Mode A/B without connecting the scanner to the proper host, it may appear unable to scan. If this happens, scan a different RS-232 host type within 5 seconds of cycling power to the scanner.**

**The CUTE host disables all parameter scanning, including Set Defaults. If you inadvertently select CUTE, scan \*Enable Parameter Bar Code Scanning (1) on page 5-6, then change the host selection.**

## RS-232 Host Parameters (continued)

Selecting ICL, Fujitsu, Wincor-Nixdorf Mode A, Wincor-Nixdorf Mode B, OPOS/JPOS, Olivetti, Omron, or CUTE-LP/LG bar code readers transmits the code ID characters listed in [Table 10-3](#). These code ID characters are not programmable and are separate from the Transmit Code ID feature. Do not enable the Transmit Code ID feature for these terminals.

**Table 10-3** Terminal Specific Code ID Characters

Code Type	ICL	Fujitsu	Wincor-Nixdorf Mode A	Wincor-Nixdorf Mode B/ OPOS/JPOS	Olivetti	Omron	CUTE
UPC-A	A	A	A	A	A	A	A
UPC-E	E	E	C	C	C	E	None
EAN-8/JAN-8	FF	FF	B	B	B	FF	None
EAN-13/JAN-13	F	F	A	A	A	F	A
Code 39	C <len>	None	M	M	M <len>	C <len>	3
Code 39 Full ASCII	None	None	M	M	None	None	3
Codabar	N <len>	None	N	N	N <len>	N <len>	None
Code 128	L <len>	None	K	K	K <len>	L <len>	5
I 2 of 5	I <len>	None	I	I	I <len>	I <len>	1
Code 93	None	None	L	L	L <len>	None	None
D 2 of 5	H <len>	None	H	H	H <len>	H <len>	2
GS1-128	L <len>	None	P	P	P <len>	L <len>	5
MSI	None	None	O	O	O <len>	None	None
Bookland EAN	F	F	A	A	A	F	None
Trioptic	None	None	None	None	None	None	None
Code 11	None	None	None	None	None	None	None
IATA	H<len>	None	H	H	H<len>	H<len>	2
Code 32	None	None	None	None	None	None	None
GS1 DataBar Variants	None	None	E	E	None	None	None
PDF417	None	None	Q	Q	None	None	6
Data Matrix	None	None	R	R	None	None	4
GS1 Data Matrix	None	None	W	W	None	None	None
QR Codes	None	None	U	U	None	None	7
GS1 QR	None	None	X	X	None	None	None



**Table 10-3** Terminal Specific Code ID Characters (Continued)

Code Type	ICL	Fujitsu	Wincor-Nixdorf Mode A	Wincor-Nixdorf Mode B/ OPOS/JPOS	Olivetti	Omron	CUTE
Aztec/Aztec Rune	None	None	V	V	None	None	8
Maxicode	None	None	T	T	None	None	None
MicroPDF	None	None	S	S	None	None	6

## RS-232 Host Types

To select an RS-232 host interface, scan one of the following bar codes.

- ✓ **NOTE** For a list of supported scanner functionality by communication protocol, see [Appendix J, Communication Protocol Functionality](#).

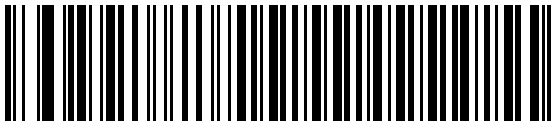

\*Standard RS-232<sup>1</sup>

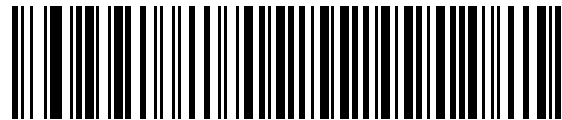

ICL RS-232

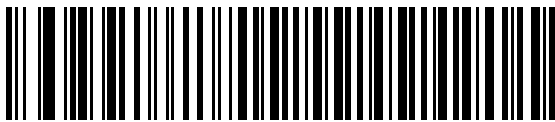

Wincor-Nixdorf RS-232 Mode A

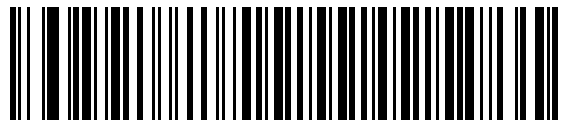

Wincor-Nixdorf RS-232 Mode B

<sup>1</sup>Scanning Standard RS-232 activates the RS-232 driver, but does not change port settings (e.g., parity, data bits, handshaking). Selecting another RS-232 host type bar code changes these settings.

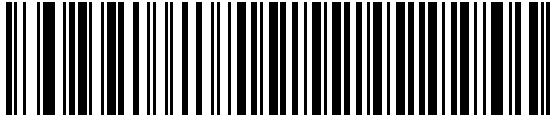
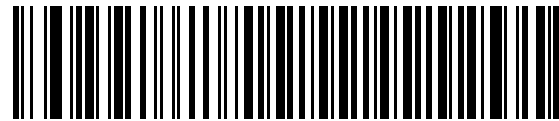
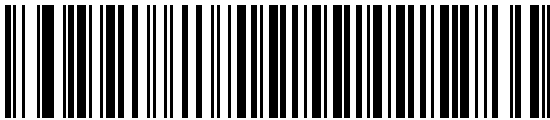
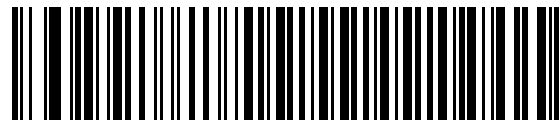
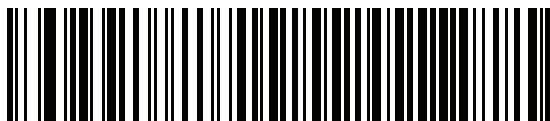
**RS-232 Host Types (continued)****Olivetti ORS450****Omron****OPOS/JPOS****Fujitsu RS-232****CUTE<sup>2</sup>**

<sup>2</sup>The CUTE host disables all parameter scanning, including Set Defaults. If you inadvertently select CUTE, scan [\\*Enable Parameter Bar Code Scanning \(1\) on page 5-6](#), and then change the host selection.

## Baud Rate

Baud rate is the number of bits of data transmitted per second. Scan one of the following bar codes to set the scanner's baud rate to match the baud rate setting of the host device. Otherwise, data may not reach the host device or may reach it in distorted form.

✓ **NOTE** The scanner does not support baud rates below 9600.

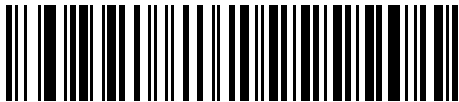

**\*Baud Rate 9600**



**Baud Rate 19,200**

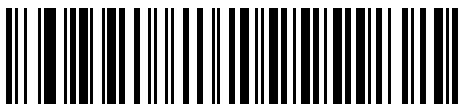

**Baud Rate 38,400**

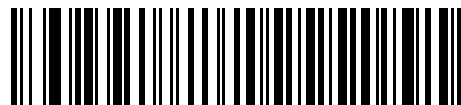

**Baud Rate 57,600**

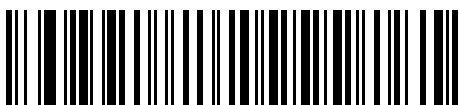

**Baud Rate 115,200**

## Parity

A parity check bit is the most significant bit of each ASCII coded character. Scan one of the following bar codes to select the parity type according to host device requirements:

- **Odd** - This sets the parity bit value to 0 or 1, based on data, to ensure that the coded character contains an odd number of 1 bits.
- **Even** - This sets the parity bit value to 0 or 1, based on data, to ensure that the coded character contains an even number of 1 bits.
- **None** - No parity bit is required.

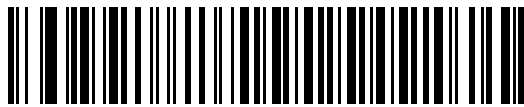

Odd

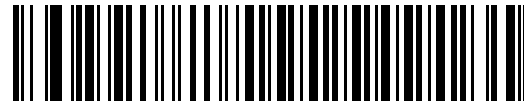

Even

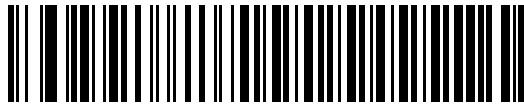

\*None

## Stop Bits

The stop bit(s) at the end of each transmitted character marks the end of transmission of one character and prepares the receiving device for the next character in the serial data stream. Scan one of the following bar codes to set the number of stop bits (one or two) based on the number the receiving host can accommodate.

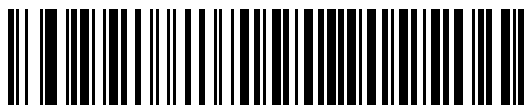

\*1 Stop Bit



2 Stop Bits

## Data Bits

This parameter allows the scanner to interface with devices requiring a 7-bit or 8-bit ASCII protocol.

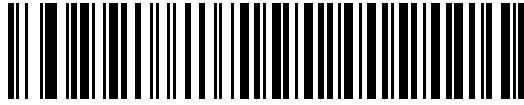

7-bit

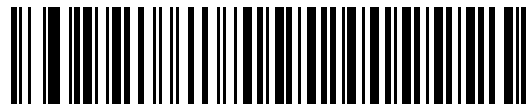

\*8-bit

## Check Receive Errors

Scan one of the following bar codes to set whether to check the parity, framing, and overrun of received characters. The parity value of received characters is verified against the value set for [Parity on page 10-9](#).

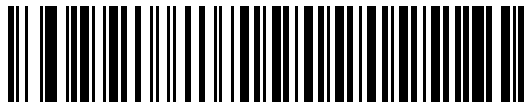

\*Check For Received Errors



Do Not Check For Received Errors

## Hardware Handshaking

The data interface consists of an RS-232 port designed to operate either with or without the hardware handshaking lines Request to Send (RTS) and Clear to Send (CTS).

If hardware handshaking and software handshaking are both enabled, hardware handshaking takes precedence.

✓ **NOTE** The DTR signal is jumpered to the active state.

Options:

- **None** - This disables hardware handshaking and transmits scan data as it becomes available.
- **Standard RTS/CTS** - This sets standard RTS/CTS hardware handshaking and transmits scanned data according to the following sequence:
  - a. The scanner reads the CTS line for activity:
    - If the CTS line is de-asserted, the scanner asserts the RTS line and waits up to *Host Serial Response Timeout on page 10-15* for the host to assert CTS, and then transmits data when asserted. If, after the timeout, the CTS line is not asserted, the scanner sounds a transmit error and discards the data.
    - If CTS is asserted, the scanner waits up to *Host Serial Response Timeout* for the host to de-assert CTS. If after this timeout the CTS line is still asserted, the scanner sounds a transmit error and discards the scanned data.
  - b. The scanner de-asserts RTS after sending the last character of data.
  - c. The host negates CTS. The scanner checks for a de-asserted CTS upon the next data transmission. During data transmission, if CTS is deasserted for more than 50 ms between characters, the scanner sounds a transmit error and discards the data. The data must be re-scanned.
- **RTS/CTS Option 1** - The scanner asserts RTS before transmitting and ignores the state of CTS. The scanner de-asserts RTS when transmission completes.
- **RTS/CTS Option 2** - RTS is always high or low (user-programmed logic level). However, the scanner waits for the host to assert CTS before transmitting data. If CTS is not asserted within the *Host Serial Response Timeout*, the scanner sounds a transmit error and discards the data. During data transmission, if CTS is de-asserted for more than 50 ms between characters, the scanner sounds a transmit error and discards the data.
- **RTS/CTS Option 3** - This transmits scanned data according to the following sequence:
  - a. The scanner asserts RTS before data transmission, regardless of the state of CTS.
  - b. The scanner waits up to the *Host Serial Response Timeout* for the host to assert CTS, and then transmits data when asserted. If, after the timeout, the CTS line is not asserted, the scanner sounds a transmit error and discards the data.
  - c. The scanner de-asserts RTS after sending the last character of data.
  - d. The host negates CTS. The scanner checks for a de-asserted CTS upon the next data transmission. During data transmission, if CTS is deasserted for more than 50 ms between characters, the scanner sounds a transmit error and discards the data. The data must be re-scanned.

## Hardware Handshaking (continued)



**\*None**

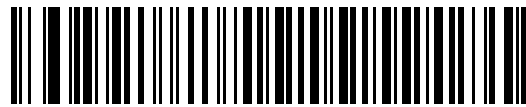

**Standard RTS/CTS**

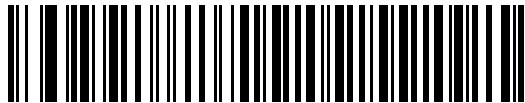

**RTS/CTS Option 1**



**RTS/CTS Option 2**

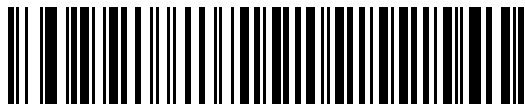

**RTS/CTS Option 3**

## Software Handshaking

This parameter offers control of data transmission in addition to, or instead of, that offered by hardware handshaking. If software handshaking and hardware handshaking are both enabled, hardware handshaking takes precedence.

Options:

- **None** - This transmits data immediately. The scanner expects no response from the host.
- **ACK/NAK** - After transmitting data, the scanner waits for an ACK or NAK response from the host. If it receives a NAK, the scanner transmits the data again and waits for an ACK or NAK. After three unsuccessful attempts to send data after receiving NAKs, the scanner sounds a transmit error and discards the data.

The scanner waits up to the programmable *Host Serial Response Timeout* to receive an ACK or NAK. If the scanner does not get a response in this time, it sounds a transmit error and discards the data. There are no reattempts.

- **ENQ** - The scanner waits for an ENQ character from the host before transmitting data. If it does not receive an ENQ within the *Host Serial Response Timeout*, the scanner sounds a transmit error and discards the data. The host must transmit an ENQ character at least every *Host Serial Response Timeout* to prevent transmission errors.
- **ACK/NAK with ENQ** - This combines the two previous options. An additional ENQ is not required to re-transmit data due to a NAK from the host.
- **XON/XOFF** - An XOFF character stops data transmission until the scanner receives an XON character. There are two situations for XON/XOFF:
  - The scanner receives an XOFF before it has data to send. When the scanner has data, it waits up to the *Host Serial Response Timeout* for an XON character before transmitting. If it does not receive the XON within this time, the scanner sounds a transmit error and discards the data.
  - The scanner receives an XOFF during data transmission and stops transmission after sending the current byte. When the scanner receives an XON character, it sends the rest of the data. The scanner waits indefinitely for the XON.



## Software Handshaking (continued)

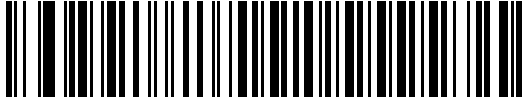

**\*None**

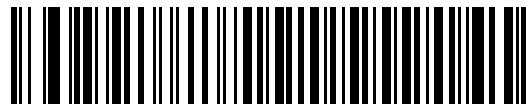

**ACK/NAK**

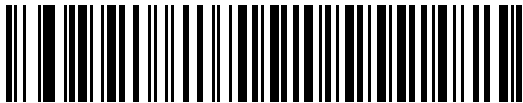

**ENQ**

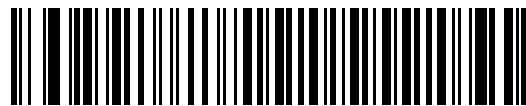

**ACK/NAK with ENQ**



**XON/XOFF**

## Host Serial Response Timeout

Scan one of the following bar codes to specify how long the scanner waits for an ACK, NAK, or CTS before determining that a transmission error occurred. This only applies when in one of the ACK/NAK software handshaking modes, or RTS/CTS hardware handshaking mode.



**\*Minimum: 2 Seconds**



**Low: 2.5 Seconds**

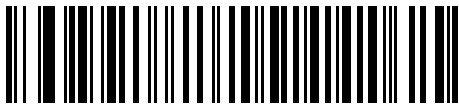

**Medium: 5 Seconds**



**High: 7.5 Seconds**

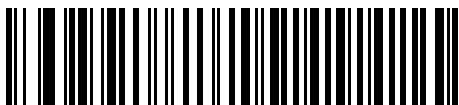

**Maximum: 9.9 Seconds**

## RTS Line State

Scan one of the following bar codes to set the idle state of the serial host RTS line to **Low RTS** or **High RTS**.



**\*Host: Low RTS**



**Host: High RTS**

## Beep on <BEL>

Scan one of the following bar codes to set whether the scanner issues a beep when it detects a <BEL> character on the RS-232 serial line. <BEL> indicates an illegal entry or other important event.

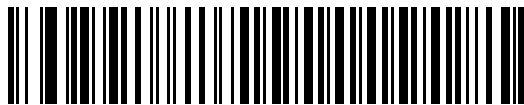

**Beep On <BEL> Character  
(Enable)**



**\*Do Not Beep On <BEL> Character  
(Disable)**

## Intercharacter Delay

Scan one of the following bar codes to specify the intercharacter delay inserted between character transmissions.

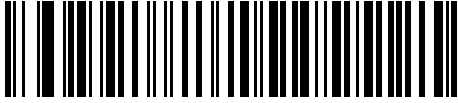

**\*Minimum: 0 msec**



**Low: 25 msec**

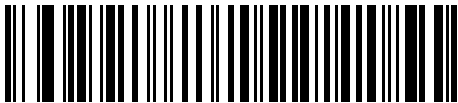

**Medium: 50 msec**



**High: 75 msec**

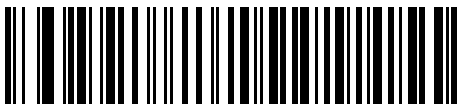

**Maximum: 99 msec**

## Nixdorf Beep/LED Options

If you selected Nixdorf Mode B, scan one of the following bar codes to indicate when the scanner beeps and turns on its LED after a decode.



**\*Normal Operation**  
**(Beep/LED Immediately After Decode)**



**Beep/LED After Transmission**

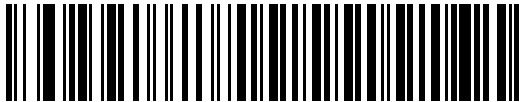

**Beep/LED After CTS Pulse**

## Bar Codes with Unknown Characters

Unknown characters are characters the host does not recognize. Scan **Send Bar Codes With Unknown Characters** to send all bar code data except for unknown characters. The scanner issues no error beeps.

Scan **Do Not Send Bar Codes With Unknown Characters** to send bar code data up to the first unknown character. The scanner issues an error beep.

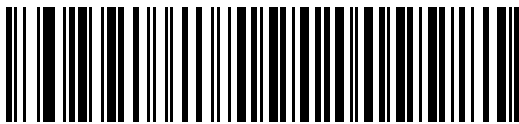

**\*Send Bar Codes With Unknown Characters**

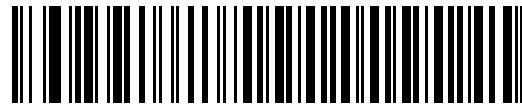

**Do Not Send Bar Codes With Unknown Characters**

---

## ASCII Character Set for RS-232

See [Appendix I, ASCII Character Sets](#) for Prefix/Suffix values. The values in [Table I-1](#) can be assigned as prefixes or suffixes for ASCII character data transmission.

# CHAPTER 11 IBM 468X / 469X INTERFACE

---

## Introduction

This chapter describes how to set up the cradle with an IBM 468X/469X host.

The scanner ships with the settings shown in [Table 11-1 on page 11-3](#) (also see [Appendix A, Standard Default Parameters](#) for all defaults). If the default values suit requirements, programming is not necessary.

---

## Setting Parameters

To set feature values, scan a single bar code or a short bar code sequence. The settings are stored in non-volatile memory and are preserved even when the scanner powers down.

✓ **NOTE** Most computer monitors allow scanning bar codes directly on the screen. When scanning from the screen, be sure to set the document magnification to a level where you can see the bar code clearly, and bars and/or spaces do not merge.

To return all features to default values, scan [Set Factory Defaults on page 5-5](#). Throughout the programming bar code menus, asterisks (\*) indicate default values.



\* Indicates default      \*Enable Parameter      Feature/option

## Scanning Sequence Examples

In most cases scanning one bar code sets the parameter value. For example, to select the Port 9B address, scan the **Hand-Held Scanner Emulation (Port 9B)** bar code under [Port Address on page 11-4](#). The scanner issues a fast warble beep and the LED turns green, signifying a successful parameter entry.

Other parameters require scanning several bar codes. See the parameter descriptions for this procedure.

## Errors While Scanning

Unless otherwise specified, to correct an error during a scanning sequence, just re-scan the correct parameter.

---

## Connecting an IBM 468X/469X Host

Connect the scanner directly to the host computer.

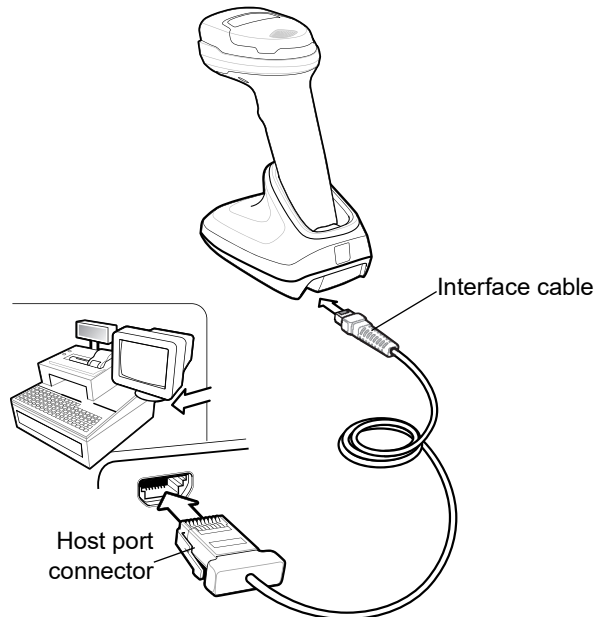

**Figure 11-1** IBM Connection

✓ **NOTE** Interface cables vary depending on configuration. The connectors can be different than those illustrated in [Figure 11-1](#), but the steps to connect the scanner are the same.

1. Attach the modular connector of the IBM 46XX interface cable to the cable interface port on the cradle.
2. Connect the other end of the IBM 46XX interface cable to the appropriate port on the host (typically Port 9).
3. The scanner automatically detects the host interface type, but there is no default setting. Scan the appropriate bar code from [Port Address on page 11-4](#) to select the port address.
4. To modify any other parameter options, scan the appropriate bar codes in this chapter.

✓ **NOTE** The only required configuration is the port address. The IBM system typically controls other scanner parameters.

If problems occur with the system, see [Troubleshooting on page 4-3](#).

## IBM Parameter Defaults

[Table 11-1](#) lists defaults for IBM host parameters. Change these values in one of two ways:

- Scan the appropriate bar codes in this chapter. The new value replaces the standard default value in memory. To recall default parameter values, see [Default Parameters on page 5-5](#).
- Configure the scanner using the 123Scan configuration program. See [Chapter 2, 123Scan and Software Tools](#).

✓ **NOTE** See [Appendix A, Standard Default Parameters](#) for all user preference, host, symbology, and miscellaneous default parameters.

**Table 11-1** *IBM Parameter Defaults*

Parameter	Default	Page Number
<b>IBM 468X/469X Host Parameters</b>		
Port Address	None	<a href="#">11-4</a>
Convert Unknown to Code 39	Disable	<a href="#">11-5</a>
RS-485 Beep Directive	Ignore	<a href="#">11-5</a>
RS-485 Bar Code Configuration Directive	Ignore	<a href="#">11-6</a>
IBM-485 Specification Version	Original Specification	<a href="#">11-6</a>



---

## IBM Host Parameters

### Port Address

Scan one of the following bar codes to select the IBM 468X/469X port.

- ✓ **NOTE** Scanning a Port Address bar code enables the RS-485 interface on the scanner.
- ✓ **NOTE** For a list of supported scanner functionality by communication protocol, see [Appendix J, Communication Protocol Functionality](#).

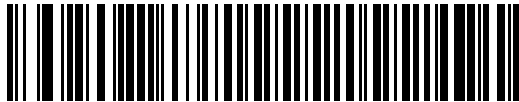

\*None



Hand-Held Scanner Emulation (Port 9B)

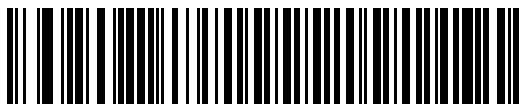

Non-IBM Scanner Emulation (Port 5B)

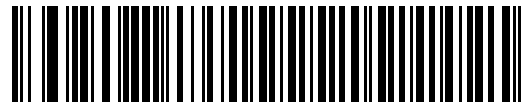

Table-Top Scanner Emulation (Port 17)

## Convert Unknown to Code 39

Scan one of the following bar codes to enable or disable converting unknown bar code type data to Code 39.



**Enable Convert Unknown to Code 39**



**\*Disable Convert Unknown to Code 39**

## RS-485 Beep Directive

The IBM RS-485 host can send a beeper configuration request to the scanner. Scan **Ignore Beep Directive** to prevent the scanner from processing the host request. All directives are still acknowledged to the host as if they were processed.



**Honor Beep Directive**



**\*Ignore Beep Directive**

## RS-485 Bar Code Configuration Directive

The IBM RS-485 host can enable and disable code types. Scan **Ignore Bar Code Configuration Directive** to prevent the scanner from processing the host request. All directives are still acknowledged to the IBM RS-485 host as if they were processed.



**Honor Bar Code Configuration Directive**



**\*Ignore Bar Code Configuration Directive**

## IBM-485 Specification Version

### Parameter # 1729 (SSI # F8h 06h C1h)

The IBM interface specification version selected defines how code types are reported over the IBM interface.

When you scan **Original Specification**, only Symbologies that were historically supported on each individual port are reported as known. When you scan Version 2.2, all Symbologies covered in the newer IBM specification are reported as known with their respective code types.

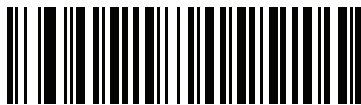

**\*Original Specification  
(0)**



**Version 2.2  
(1)**

# CHAPTER 12 KEYBOARD WEDGE INTERFACE

---

## Introduction

This chapter describes how to set up a keyboard wedge interface with the cradle. The cradle connects between the keyboard and host computer and translates bar code data into keystrokes, which the host accepts as if they originated from the keyboard. This mode adds bar code reading functionality to a system designed for manual keyboard input. Keyboard keystrokes are simply passed through.

The scanner ships with the settings shown in [Table 12-1 on page 12-3](#) (also see [Appendix A, Standard Default Parameters](#) for all defaults). If the default values suit requirements, programming is not necessary.

---

## Setting Parameters

To set feature values, scan a single bar code or a short bar code sequence. The settings are stored in non-volatile memory and are preserved even when the scanner powers down.

✓ **NOTE** Most computer monitors allow scanning bar codes directly on the screen. When scanning from the screen, be sure to set the document magnification to a level where you can see the bar code clearly, and bars and/or spaces do not merge.

To return all features to default values, scan a bar code in [Default Parameters on page 5-5](#). Throughout the programming bar code menus, asterisks (\*) indicate default values.

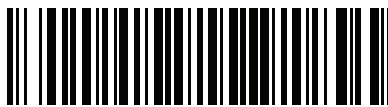

\* Indicates default      \*Enable Parameter      Feature/option

## Scanning Sequence Examples

In most cases, scanning one bar code sets the parameter value. For example, to select a medium keystroke delay, scan the **Medium Delay (20 msec)** bar code under [Keystroke Delay on page 12-5](#). The scanner issues a fast warble beep and the LED turns green, signifying a successful parameter entry.

Other parameters require scanning several bar codes. See the parameter descriptions for this procedure.

## Errors While Scanning

Unless otherwise specified, to correct an error during a scanning sequence, just re-scan the correct parameter.

## Connecting a Keyboard Wedge Interface

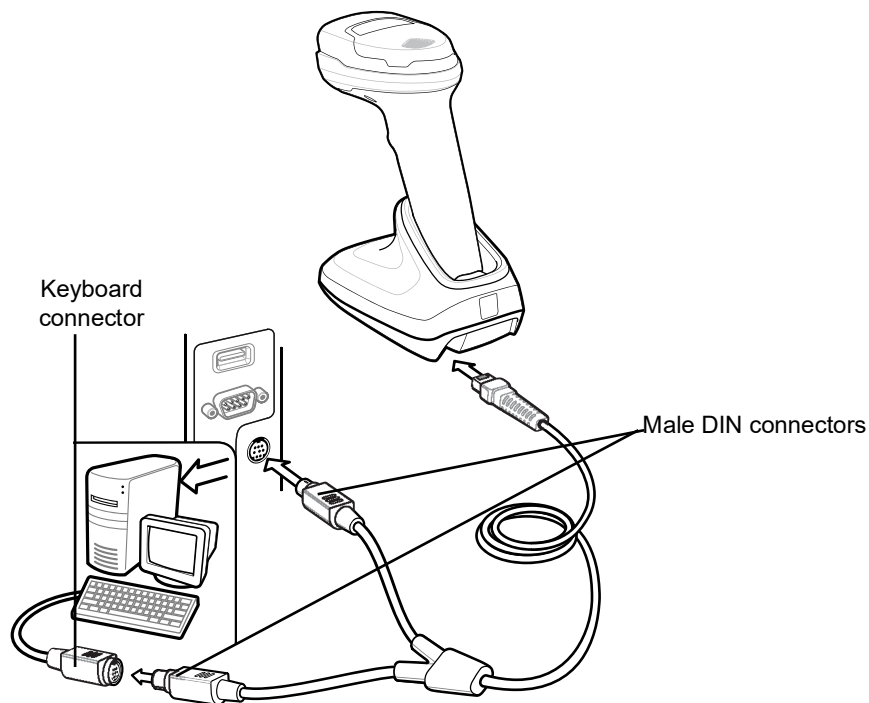

Figure 12-1 Keyboard Wedge Connection

✓ **NOTE** Interface cables vary depending on configuration. The connectors can be different than those illustrated in [Figure 12-1](#), but the steps to connect the scanner are the same.

1. Turn off the host and unplug the keyboard connector.
2. Attach the modular connector of the Y-cable to the cable interface port on the cradle.
3. Connect the round male DIN host connector of the Y-cable to the keyboard port on the host device.
4. Connect the round female DIN keyboard connector of the Y-cable to the keyboard connector.
5. If required, attach the optional power supply to the connector in the middle of the Y-cable.
6. Ensure that all connections are secure.
7. Turn on the host system.
8. The digital scanner automatically detects the host interface type and uses the default setting. If the default (\*) does not meet your requirements, scan [IBM PC/AT & IBM PC Compatibles on page 12-4](#).
9. To modify any other parameter options, scan the appropriate bar codes in this guide.

If problems occur with the system, see [Troubleshooting on page 4-3](#).

## Keyboard Wedge Parameter Defaults

*Table 12-1* lists the defaults for Keyboard Wedge host parameters. To change any option, scan the appropriate bar code(s) in *Keyboard Wedge Host Parameters on page 12-4*.



**NOTE** See [Appendix B, Country Codes](#) for Keyboard Wedge Country Keyboard Types (Country Codes).

See [Appendix A, Standard Default Parameters](#) for all user preferences, hosts, symbologies, and miscellaneous default parameters.

**Table 12-1** *Keyboard Wedge Host Default Table*

Parameter	Default	Page Number
<b>Keyboard Wedge Host Parameters</b>		
Keyboard Wedge Host Type	IBM AT Notebook	<a href="#">12-4</a>
Bar Codes with Unknown Characters	Send Bar Codes with Unknown Characters	<a href="#">12-4</a>
Keystroke Delay	No Delay	<a href="#">12-5</a>
Intra-keystroke Delay	Disable	<a href="#">12-5</a>
Alternate Numeric Keypad Emulation	Enable	<a href="#">12-6</a>
Quick Keypad Emulation	Enable	<a href="#">12-6</a>
Simulated Caps Lock	Disable	<a href="#">12-7</a>
Caps Lock Override	Disable	<a href="#">12-7</a>
Convert Case	Do Not Convert	<a href="#">12-8</a>
Function Key Mapping	Disable	<a href="#">12-8</a>
FN1 Substitution	Disable	<a href="#">12-9</a>
Send Make and Break	Send	<a href="#">12-9</a>

---

## Keyboard Wedge Host Parameters

### Keyboard Wedge Host Types

Select the Keyboard Wedge host by scanning one of the bar codes below.



**NOTE** For a list of supported scanner functionality by communication protocol, see [Appendix J, Communication Protocol Functionality](#).



**IBM PC/AT & IBM PC Compatibles**

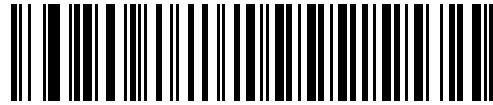

**\*IBM AT Notebook**

### Bar Codes with Unknown Characters

Unknown characters are characters the host does not recognize. Scan **Send Bar Codes With Unknown Characters** to send all bar code data except for unknown characters. The scanner issues no error beeps.

Scan **Do Not Send Bar Codes With Unknown Characters** to send bar code data up to the first unknown character. The scanner issues an error beep.



**\*Send Bar Codes with Unknown Characters**

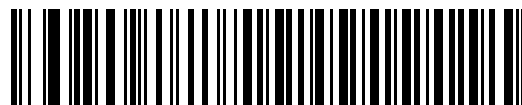

**Do Not Send Bar Codes with Unknown Characters**

## Keystroke Delay

This is the delay in milliseconds between emulated keystrokes. Scan one of the following bar codes to increase the delay when hosts require a slower data transmission.



\*No Delay



Medium Delay (20 msec)

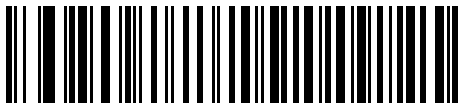

Long Delay (40 msec)

## Intra-keystroke Delay

Scan **Enable Intra-keystroke Delay** to insert an additional delay between each emulated key press and release. This also sets *Keystroke Delay* to a minimum of 5 msec.



Enable Intra-keystroke Delay



\*Disable Intra-keystroke Delay



## Alternate Numeric Keypad Emulation

This allows emulation of most other country keyboard types not listed in [Appendix B, Country Codes](#) in a Microsoft® operating system environment.

- ✓ **NOTE** If your keyboard type is not listed in the country code list (see *USB and Keyboard Wedge Country Keyboard Types (Country Codes)* on page B-2), disable [Quick Keypad Emulation on page 12-6](#) and ensure [Alternate Numeric Keypad Emulation on page 12-6](#) is enabled.

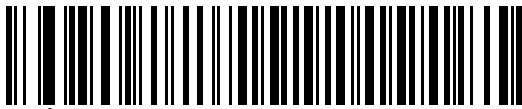

\*Enable Alternate Numeric Keypad

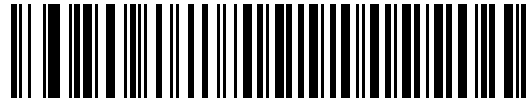

Disable Alternate Numeric Keypad

## Quick Keypad Emulation

This enables faster keypad emulation where character value sequences are only sent for characters not found on the keyboard.

- ✓ **NOTE** This option applies only when [Alternate Numeric Keypad Emulation](#) is enabled.



\*Enable Quick Keypad Emulation

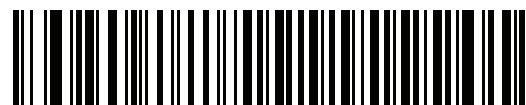

Disable Quick Keypad Emulation

## Simulated Caps Lock

Scan **Enable Caps Lock** to invert upper and lower case characters on the bar code as if the Caps Lock state is enabled on the keyboard. This inversion occurs regardless of the keyboard's Caps Lock state. Note that Simulated Caps Lock applies to ASCII alpha characters only.

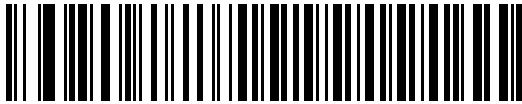

**Enable Caps Lock**



**\*Disable Caps Lock**

## Caps Lock Override

Scan **Enable Caps Lock Override** for AT or AT Notebook hosts to preserve the case of the data regardless of the state of the Caps Lock key. Therefore, an 'A' in the bar code transmits as an 'A' regardless of the setting of the keyboard's Caps Lock key.

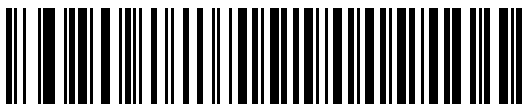

**Enable Caps Lock Override**



**\*Disable Caps Lock Override**



**NOTE** If both Simulated Caps Lock and Caps Lock Override are enabled, Caps Lock Override takes precedence.

## Convert Case

Scan one of the following bar codes to convert all bar code data to the selected case.

✓ **NOTE** Convert Case applies to ASCII characters only.



**Convert to Upper Case**



**Convert to Lower Case**



**\*Do Not Convert**

## Function Key Mapping

ASCII values under 32 are normally sent as control key sequences (see [Table I-1 on page I-1](#)). Scan **Enable Function Key Mapping** to send the keys in bold in place of the standard key mapping. Table entries that do not have a bold entry remain the same whether or not you enable this parameter.



**Enable Function Key Mapping**

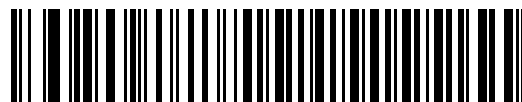

**\*Disable Function Key Mapping**

## FN1 Substitution

Scan **Enable FN1 Substitution** to replace FN1 characters in an EAN128 bar code with a user-selected keystroke (see [FN1 Substitution Values on page 5-36](#)).



**Enable FN1 Substitution**

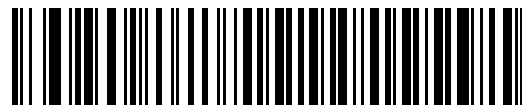

**\*Disable FN1 Substitution**

## Send Make and Break

Scan **Send Make and Break Scan Codes** to prevent sending the scan codes for releasing a key.



**\*Send Make and Break Scan Codes**



**Send Make Scan Code Only**



**NOTE** Windows-based systems must use **Send Make and Break Scan Codes**.

## Keyboard Map

The following keyboard map is a reference for prefix/suffix keystroke parameters. To program the prefix/suffix values, see the bar codes on [page 5-33](#).

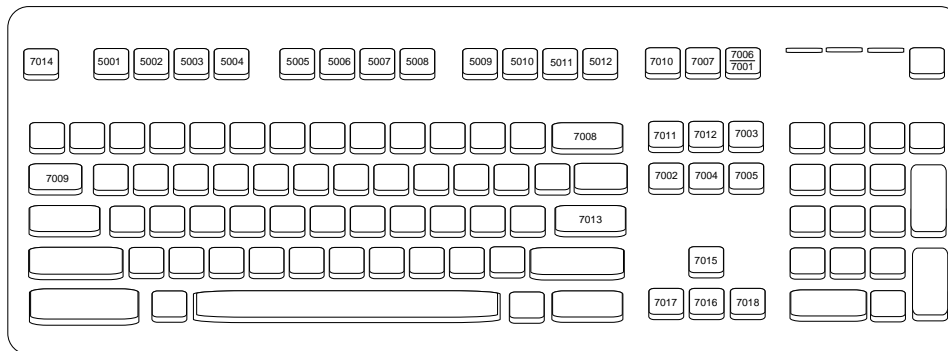

Figure 12-2 IBM PS2 Type Keyboard

## ASCII Character Set for Keyboard Wedge

✓ **NOTE** Code 39 Full ASCII interprets the bar code special character (\$ + % /) preceding a Code 39 character and assigns an ASCII character value to the pair. For example, if you enable Code 39 Full ASCII and scan **+B**, it transmits as **b**, **%J** as **?**, and **%V** as **@**. Scanning **ABC%I** outputs the keystroke equivalent of **ABC >**.

See [Appendix I, ASCII Character Sets](#) for the following:

- ASCII Character Set ([Table I-1 on page I-1](#))
- ALT Key Character Set ([Table I-2 on page I-6](#))
- GUI Key Character Set ([Table I-3 on page I-7](#))
- F Key Character Set ([Table I-5 on page I-10](#))
- Numeric Key Character Set ([Table I-6 on page I-11](#))
- Extended Key Character Set ([Table I-7 on page I-12](#)).

# CHAPTER 13 SYMBOLOGIES

---

## Introduction

You can program the scanner to perform various functions, or activate different features. This chapter describes symbology features and provides programming bar codes for selecting these features.

The scanner ships with the settings shown in [Table 13-1 on page 13-2](#) (also see [Appendix A, Standard Default Parameters](#) for all defaults). If the default values suit requirements, programming is not necessary.

---

## Setting Parameters

To set feature values, scan a single bar code or a short bar code sequence. The settings are stored in non-volatile memory and are preserved even when the scanner powers down.

- ✓ **NOTE** Most computer monitors allow scanning bar codes directly on the screen. When scanning from the screen, be sure to set the document magnification to a level where you can see the bar code clearly, and bars and/or spaces do not merge.

If not using a USB cable, select a host type (see each host chapter for specific host information) after the power-up beeps sound. This is only necessary upon the first power-up when connected to a new host.

To return all features to default values, see [Default Parameters on page 5-5](#). Throughout the programming bar code menus, asterisks (\*) indicate default values.

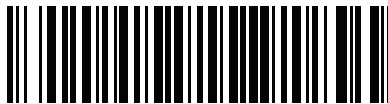

\* Indicates default — **\*Enable Parameter** — Feature/option

## Scanning Sequence Examples

In most cases, scanning one bar code sets the parameter value. For example, to transmit bar code data without the UPC-A check digit, scan the **Do Not Transmit UPC-A Check Digit** bar code under [Transmit UPC-A Check Digit on page 13-18](#). The scanner issues a fast warble beep and the LED turns green, signifying a successful parameter entry.

Other parameters, such as **Set Lengths for D 2 of 5**, require scanning several bar codes. See the parameter descriptions for this procedure.

## Errors While Scanning

Unless otherwise specified, to correct an error during a scanning sequence, just re-scan the correct parameter.

## Symbology Parameter Defaults

[Table 13-1](#) lists defaults for all symbology parameters. Change these values in one of two ways:

- Scan the appropriate bar codes in this chapter. The new value replaces the standard default value in memory. To recall the default parameter values, see [Default Parameters on page 5-5](#).
- Configure the scanner using the 123Scan configuration program. See [Chapter 13, Symbologies](#).

✓ **NOTE** See [Appendix A, Standard Default Parameters](#) for all user preference, host, symbology, and miscellaneous default parameters.

**Table 13-1** Symbology Parameter Defaults

Parameter	Parameter Number <sup>1</sup>	SSI Number <sup>2</sup>	Default	Page Number
<b>Enable/Disable All Code Types</b>				<a href="#">13-8</a>
<b>1D Symbologies</b>				
<b>UPC/EAN/JAN</b>				
UPC-A	1	01h	Enable	<a href="#">13-9</a>
UPC-E	2	02h	Enable	<a href="#">13-9</a>
UPC-E1	12	0Ch	Disable	<a href="#">13-10</a>
EAN-8/JAN 8	4	04h	Enable	<a href="#">13-10</a>
EAN-13/JAN 13	3	03h	Enable	<a href="#">13-11</a>
Bookland EAN	83	53h	Disable	<a href="#">13-11</a>
Bookland ISBN Format	576	F1h 40h	ISBN-10	<a href="#">13-12</a>
ISSN EAN	617	F1h 69h	Disable	<a href="#">13-12</a>

1. Parameter number decimal values are used for programming via RSM commands.

2. SSI number hex values are used for programming via SSI commands.

**Table 13-1** Symbology Parameter Defaults (Continued)

Parameter	Parameter Number <sup>1</sup>	SSI Number <sup>2</sup>	Default	Page Number
Decode UPC/EAN/JAN Supplementals (2 and 5 digits)	16	10h	Ignore	13-13
User-Programmable Supplementals			000	13-16
Supplemental 1:	579	F1h 43h		
Supplemental 2:	580	F1h 44h		
UPC/EAN/JAN Supplemental Redundancy	80	50h	10	13-16
Decode UPC/EAN/JAN Supplemental AIM ID Format	672	F1h A0h	Combined	13-17
Transmit UPC-A Check Digit	40	28h	Enable	13-18
Transmit UPC-E Check Digit	41	29h	Enable	13-18
Transmit UPC-E1 Check Digit	42	2Ah	Enable	13-19
Transmit Ean-8 Check Digit	1881	F8 07 59h	Enable	13-19
Transmit Ean-13 Check Digit	1882	F8 07 5Ah	Enable	13-20
UPC-A Preamble	34	22h	System Character	13-21
UPC-E Preamble	35	23h	System Character	13-22
UPC-E1 Preamble	36	24h	System Character	13-23
Convert UPC-E to UPC-A	37	25h	Disable	13-24
Convert UPC-E1 to UPC-A	38	26h	Disable	13-24
EAN/JAN Zero Extend	39	27h	Disable	13-25
UCC Coupon Extended Code	85	55h	Disable	13-25
Coupon Report	730	F1h DAh	New Coupon Format	13-26
UPC Reduced Quiet Zone	1289	F8h 05h 09h	Disable	13-26
<b>Code 128</b>				
Code 128	8	08h	Enable	13-27
Set Lengths for Code 128	209, 210	D1h, D2h	1 - 55	13-27
GS1-128 (formerly UCC/EAN-128)	14	0Eh	Enable	13-28
ISBT 128	84	54h	Disable	13-29
ISBT Concatenation	577	F1h 41h	Disable	13-30
Check ISBT Table	578	F1h 42h	Enable	13-31

1. Parameter number decimal values are used for programming via RSM commands.

2. SSI number hex values are used for programming via SSI commands.



**Table 13-1** Symbology Parameter Defaults (Continued)

Parameter	Parameter Number <sup>1</sup>	SSI Number <sup>2</sup>	Default	Page Number
ISBT Concatenation Redundancy	223	DFh	10	<a href="#">13-31</a>
Code 128 <FNC4>	1254	F8h 04h E6h	Honor	<a href="#">13-32</a>
Code 128 Security Level	751	F1h EFh	Security Level 1	<a href="#">13-32</a>
Code 128 Reduced Quiet Zone	1208	F8h 04h B8h	Disable	<a href="#">13-33</a>
<b>Code 39</b>				
Code 39	0	00h	Enable	<a href="#">13-34</a>
Trioptic Code 39	13	0Dh	Disable	<a href="#">13-34</a>
Convert Code 39 to Code 32 (Italian Pharmacy Code)	86	56h	Disable	<a href="#">13-35</a>
Code 32 Prefix	231	E7h	Disable	<a href="#">13-35</a>
Set Lengths for Code 39	18, 19	12h, 13h	1 - 55	<a href="#">13-36</a>
Code 39 Check Digit Verification	48	30h	Disable	<a href="#">13-37</a>
Transmit Code 39 Check Digit	43	2Bh	Disable	<a href="#">13-38</a>
Code 39 Full ASCII Conversion	17	11h	Disable	<a href="#">13-38</a>
Code 39 Security Level	750	F1h EEh	Security Level 1	<a href="#">13-39</a>
Code 39 Reduced Quiet Zone	1209	F8h 04h B9h	Disable	<a href="#">13-41</a>
<b>Code 93</b>				
Code 93	9	09h	Enable	<a href="#">13-41</a>
Set Lengths for Code 93	26, 27	1Ah, 1Bh	1 - 55	<a href="#">13-42</a>
<b>Code 11</b>				
Code 11	10	0Ah	Disable	<a href="#">13-44</a>
Set Lengths for Code 11	28, 29	1Ch, 1Dh	4 to 55	<a href="#">13-44</a>
Code 11 Check Digit Verification	52	34h	Disable	<a href="#">13-46</a>
Transmit Code 11 Check Digit(s)	47	2Fh	Disable	<a href="#">13-47</a>
<b>Interleaved 2 of 5 (ITF/I 2 of 5)</b>				
Interleaved 2 of 5	6	06h	Enable	<a href="#">13-47</a>
Set Lengths for Interleaved 2 of 5	22, 23	16h, 17h	6 to 55	<a href="#">13-48</a>
Interleaved 2 of 5 Check Digit Verification	49	31h	Disable	<a href="#">13-50</a>
Transmit Interleaved 2 of 5 Check Digit	44	2Ch	Disable	<a href="#">13-51</a>

1. Parameter number decimal values are used for programming via RSM commands.
2. SSI number hex values are used for programming via SSI commands.

**Table 13-1** Symbology Parameter Defaults (Continued)

Parameter	Parameter Number <sup>1</sup>	SSI Number <sup>2</sup>	Default	Page Number
Convert Interleaved 2 of 5 to EAN-13	82	52h	Disable	<a href="#">13-51</a>
Febraban	1750	F8h 06h D6h	Disable	<a href="#">13-52</a>
Interleaved 2 of 5 Security Level	1121	F8h 04h 61h	Security Level 1	<a href="#">13-53</a>
Interleaved 2 of 5 Reduced Quiet Zone	1210	F8h 04h BAh	Disable	<a href="#">13-54</a>
<b>Discrete 2 of 5 (DTF/D 2 of 5)</b>				
Discrete 2 of 5	5	05h	Disable	<a href="#">13-54</a>
Set Lengths for Discrete 2 of 5	20, 21	14h 15h	1 to 55	<a href="#">13-55</a>
<b>Codabar (NW - 7)</b>				
Codabar	7	07h	Enable	<a href="#">13-57</a>
Set Lengths for Codabar	24, 25	18h, 19h	4 to 55	<a href="#">13-57</a>
CLSI Editing	54	36h	Disable	<a href="#">13-59</a>
NOTIS Editing	55	37h	Disable	<a href="#">13-59</a>
Codabar Upper or Lower Case Start/ Stop Characters Detection	855	F2h 57h	Upper Case	<a href="#">13-60</a>
Codabar Mod 16 Check Digit	1784	F8h 06h F8h	Disable	<a href="#">13-60</a>
Transmit Codabar Check Digit	704	F1h C0h	Disable	<a href="#">13-61</a>
<b>MSI</b>				
MSI	11	0Bh	Disable	<a href="#">13-61</a>
Set Lengths for MSI	30, 31	1Eh, 1Fh	4 to 55	<a href="#">13-62</a>
MSI Check Digits	50	32h	One	<a href="#">13-64</a>
Transmit MSI Check Digit	46	2Eh	Disable	<a href="#">13-64</a>
MSI Check Digit Algorithm	51	33h	Mod 10/Mod 10	<a href="#">13-65</a>
MSI Reduced Quiet Zone	1392	F8h 05h 70h	Disable	<a href="#">13-65</a>
<b>Chinese 2 of 5</b>				
Chinese 2 of 5	408	F0h 98h	Disable	<a href="#">13-66</a>
<b>Matrix 2 of 5</b>				
Matrix 2 of 5	618	F1h 6Ah	Disable	<a href="#">13-66</a>
Matrix 2 of 5 Lengths	619 620	F1h 6Bh F1h 6Ch	4 to 55	<a href="#">13-67</a>

1. Parameter number decimal values are used for programming via RSM commands.
2. SSI number hex values are used for programming via SSI commands.

**Table 13-1** Symbology Parameter Defaults (Continued)

Parameter	Parameter Number <sup>1</sup>	SSI Number <sup>2</sup>	Default	Page Number
Matrix 2 of 5 Check Digit	622	F1h 6Eh	Disable	<a href="#">13-68</a>
Transmit Matrix 2 of 5 Check Digit	623	F1h 6Fh	Disable	<a href="#">13-69</a>
<b>Korean 3 of 5</b>				
Korean 3 of 5	581	F1h 45h	Disable	<a href="#">13-69</a>
<b>Inverse 1D</b>	586	F1h 4Ah	Regular	<a href="#">13-70</a>
<b>GS1 DataBar</b>				
GS1 DataBar Omnidirectional (formerly GS1 DataBar-14), GS1 DataBar Truncated, GS1 DataBar Stacked, GS1 DataBar Stacked Omnidirectional	338	F0h 52h	Enable	<a href="#">13-71</a>
GS1 DataBar Limited	339	F0h 53h	Enable	<a href="#">13-71</a>
GS1 DataBar Expanded, GS1 DataBar Expanded Stacked	340	F0h 54h	Enable	<a href="#">13-72</a>
Convert GS1 DataBar to UPC/EAN/JAN	397	F0h 8Dh	Disable	<a href="#">13-72</a>
GS1 DataBar Limited Margin Check	728	F1h D8h	Level 3	<a href="#">13-73</a>
GS1 DataBar Security Level	1706	F8h 06h AAh	Level 1	<a href="#">13-74</a>
<b>Symbology-Specific Security Features</b>				
Redundancy Level	78	4Eh	1	<a href="#">13-75</a>
Security Level	77	4Dh	1	<a href="#">13-77</a>
1D Quiet Zone Level	1288	F8h 05h 08h	1	<a href="#">13-78</a>
Intercharacter Gap Size	381	F0h 7Dh	Normal	<a href="#">13-79</a>
<b>Composite Codes</b>				
Composite CC-C	341	F0h 55h	Disable	<a href="#">13-79</a>
Composite CC-A/B	342	F0h 56h	Disable	<a href="#">13-80</a>
Composite TLC-39	371	F0h 73h	Disable	<a href="#">13-80</a>
Composite Inverse	1113	F8h 04h 59h	Regular Only	<a href="#">13-81</a>
UPC Composite Mode	344	F0h 58h	UPC Never Linked	<a href="#">13-82</a>
Composite Beep Mode	398	F0h 8Eh	Beep As Each Code Type is Decoded	<a href="#">13-83</a>

1. Parameter number decimal values are used for programming via RSM commands.
2. SSI number hex values are used for programming via SSI commands.

**Table 13-1** Symbology Parameter Defaults (Continued)

Parameter	Parameter Number <sup>1</sup>	SSI Number <sup>2</sup>	Default	Page Number
GS1-128 Emulation Mode for UCC/EAN Composite Codes	427	F0h ABh	Disable	<a href="#">13-83</a>
<b>2D Symbologies</b>				
PDF417	15	0Fh	Enable	<a href="#">13-84</a>
MicroPDF417	227	E3h	Disable	<a href="#">13-84</a>
Code 128 Emulation	123	7Bh	Disable	<a href="#">13-85</a>
Data Matrix	292	F0h 24h	Enable	<a href="#">13-86</a>
GS1 Data Matrix	1336	F8h 05h 38h	Disable	<a href="#">13-86</a>
Data Matrix Inverse	588	F1h 4Ch	Inverse Autodetect	<a href="#">13-87</a>
Decode Data Matrix Mirror Images	537	F1h 19h	Auto	<a href="#">13-88</a>
Maxicode	294	F0h 26h	Disable	<a href="#">13-89</a>
QR Code	293	F0h 25h	Enable	<a href="#">13-89</a>
GS1 QR	1343	F8h 05h 3Fh	Disable	<a href="#">13-90</a>
MicroQR	573	F1h 3Dh	Enable	<a href="#">13-90</a>
Weblink QR	1947	F8 07 9Bh	Enable	<a href="#">13-91</a>
Linked QR	1847	737h	Linked QR Only	<a href="#">13-92</a>
Aztec	574	F1h 3Eh	Enable	<a href="#">13-93</a>
Aztec Inverse	589	F1h 4Dh	Inverse Autodetect	<a href="#">13-93</a>
Han Xin	1167	F8h 04h 8Fh	Disable	<a href="#">13-94</a>
Han Xin Inverse	1168	F8h 04h 90h	Regular	<a href="#">13-94</a>
Grid Matrix	1718	F8 06 B6	Disable	<a href="#">13-95</a>
Grid Matrix Inverse	1719	F8 06 B7	Regular Only	<a href="#">13-95</a>
Grid Matrix Mirror	1736	F8 06 C8	Regular Only	<a href="#">13-96</a>
DotCode	1906	F8 07 72h	Disable	<a href="#">13-97</a>
DotCode Inverse	1907	F8 07 73h	Autodetect	<a href="#">13-98</a>
DotCode Mirrored	1908	F8 07 74h	Autodetect	<a href="#">13-99</a>
DotCode Prioritize	1937	F8 07 91h	Enable	<a href="#">13-100</a>
DotCode Erasure Limit	2063	F8 08 0F	10	<a href="#">13-100</a>

1. Parameter number decimal values are used for programming via RSM commands.
2. SSI number hex values are used for programming via SSI commands.

**Table 13-1** Symbology Parameter Defaults (Continued)

Parameter	Parameter Number <sup>1</sup>	SSI Number <sup>2</sup>	Default	Page Number
<b>Postal Codes</b>				
US Postnet	89	59h	Disable	<a href="#">13-102</a>
US Planet	90	5Ah	Disable	<a href="#">13-102</a>
Transmit US Postal Check Digit	95	5Fh	Enable	<a href="#">13-103</a>
UK Postal	91	5Bh	Disable	<a href="#">13-103</a>
Transmit UK Postal Check Digit	96	60h	Enable	<a href="#">13-104</a>
Japan Postal	290	F0h 22h	Disable	<a href="#">13-104</a>
Australia Post	291	F0h 23h	Disable	<a href="#">13-105</a>
Australia Post Format	718	F1h CEh	Autodiscriminate	<a href="#">13-106</a>
Netherlands KIX Code	326	F0h 46h	Disable	<a href="#">13-107</a>
USPS 4CB/One Code/Intelligent Mail	592	F1h 50h	Disable	<a href="#">13-107</a>
UPU FICS Postal	611	F1h 63h	Disable	<a href="#">13-108</a>
Mailmark	1337	F8h 05h 39h	Disable	<a href="#">13-108</a>

1. Parameter number decimal values are used for programming via RSM commands.
2. SSI number hex values are used for programming via SSI commands.

## Enable/Disable All Code Types

Scan the **Disable All Code Types** bar code to disable all symbologies. This is useful when enabling only a few code types.

Scan **Enable All Code Types** to enable all symbologies. This is useful if you need to disable only a few code types.

**Disable All Code Types****Enable All Code Types**

---

## UPC/EAN/JAN

### UPC-A

#### Parameter # 1

#### SSI # 01h

Scan one of the following bar codes to enable or disable UPC-A.

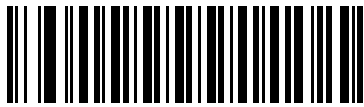

**\*Enable UPC-A  
(1)**

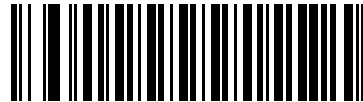

**Disable UPC-A  
(0)**

### UPC-E

#### Parameter # 2

#### SSI # 02h

Scan one of the following bar codes to enable or disable UPC-E.

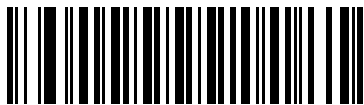

**\*Enable UPC-E  
(1)**



**Disable UPC-E  
(0)**

## UPC-E1

### Parameter # 12

### SSI # 0Ch

Scan one of the following bar codes to enable or disable UPC-E1.

✓ **NOTE** UPC-E1 is not a UCC (Uniform Code Council) approved symbology.

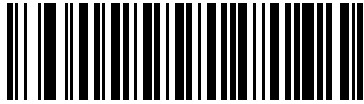

**Enable UPC-E1**  
(1)

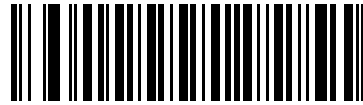

**\*Disable UPC-E1**  
(0)

## EAN-8/JAN-8

### Parameter # 4

### SSI # 04h

Scan one of the following bar codes to enable or disable EAN-8/JAN-8.

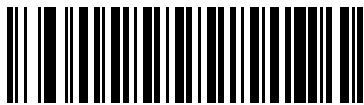

**\*Enable EAN-8/JAN-8**  
(1)



**Disable EAN-8/JAN-8**  
(0)

## EAN-13/JAN-13

### Parameter # 3

### SSI # 03h

Scan one of the following bar codes to enable or disable EAN-13/JAN-13.

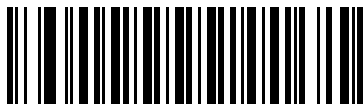

**\*Enable EAN-13/JAN-13**  
(1)



**Disable EAN-13/JAN-13**  
(0)

## Bookland EAN

### Parameter # 83

### SSI # 53h

Scan one of the following bar codes to enable or disable Bookland EAN.

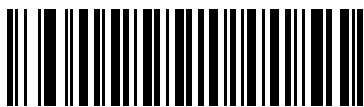

**Enable Bookland EAN**  
(1)

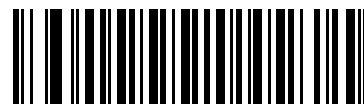

**\*Disable Bookland EAN**  
(0)



**NOTE** If you enable Bookland EAN, select a [Bookland ISBN Format](#). Also set [Decode UPC/EAN/JAN Supplementals](#) on page 13-13 to either Decode UPC/EAN/JAN with Supplementals Only, Autodiscriminate UPC/EAN/JAN With Supplementals, or Enable 978/979 Supplemental Mode.



## Bookland ISBN Format

### Parameter # 576

### SSI # F1h 40h

If you enabled Bookland EAN using [Bookland EAN on page 13-11](#), select one of the following formats for Bookland data:

- **Bookland ISBN-10** - The scanner reports Bookland data starting with 978 in traditional 10-digit format with the special Bookland check digit for backward-compatibility. Data starting with 979 is not considered Bookland in this mode.
- **Bookland ISBN-13** - The scanner reports Bookland data (starting with either 978 or 979) as EAN-13 in 13-digit format to meet the 2007 ISBN-13 protocol.



\*Bookland ISBN-10  
(0)

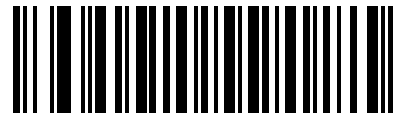

Bookland ISBN-13  
(1)

- ✓ **NOTE** For Bookland EAN to function properly, first enable Bookland EAN using [Bookland EAN on page 13-11](#), and then set [Decode UPC/EAN/JAN Supplementals on page 13-13](#) to either Decode UPC/EAN/JAN with Supplementals Only, Autodiscriminate UPC/EAN/JAN With Supplementals, or Enable 978/979 Supplemental Mode.

## ISSN EAN

### Parameter # 617

### SSI # F1h 69h

Scan one of the following bar codes to enable or disable ISSN EAN.



Enable ISSN EAN  
(1)



\*Disable ISSN EAN  
(0)

## Decode UPC/EAN/JAN Supplementals

### Parameter # 16

#### SSI # 10h

Supplementals are bar codes appended according to specific format conventions (e.g., UPC A+2, UPC E+2, EAN-13+2). The following options are available:

- **Decode UPC/EAN/JAN with Supplementals Only** - The scanner only decodes UPC/EAN/JAN symbols with supplemental characters, and ignores symbols without supplementals.
- **Ignore UPC/EAN/JAN Supplementals** - When presented with a UPC/EAN/JAN plus supplemental symbol, the scanner decodes UPC/EAN/JAN and ignores the supplemental characters.
- **Autodiscriminate UPC/EAN/JAN with Supplementals** - The scanner decodes UPC/EAN/JAN symbols with supplemental characters immediately. If the symbol does not have a supplemental, the scanner must decode the bar code the number of times set via [UPC/EAN/JAN Supplemental Redundancy on page 13-16](#) before transmitting its data to confirm that there is no supplemental.

Select one of the following **Supplemental Mode** options to immediately transmit EAN-13 bar codes starting with that prefix that have supplemental characters. If the symbol does not have a supplemental, the scanner must decode the bar code the number of times set via [UPC/EAN/JAN Supplemental Redundancy on page 13-16](#) before transmitting the data to confirm that there is no supplemental. The scanner transmits UPC/EAN/JAN bar codes that do not have that prefix immediately.

- **Enable 378/379 Supplemental Mode**
- **Enable 978/979 Supplemental Mode**

✓ **NOTE** If you select 978/979 Supplemental Mode and are scanning Bookland EAN bar codes, see [Bookland EAN on page 13-11](#) to enable Bookland EAN, and select a format using [Bookland ISBN Format on page 13-12](#).

- **Enable 977 Supplemental Mode**
- **Enable 414/419/434/439 Supplemental Mode**
- **Enable 491 Supplemental Mode**
- **Enable Smart Supplemental Mode** - This applies to EAN-13 bar codes starting with any prefix listed previously.
- **Supplemental User-Programmable Type 1** - This applies to EAN-13 bar codes starting with a 3-digit user-defined prefix. Set this using [User-Programmable Supplementals on page 13-16](#).
- **Supplemental User-Programmable Type 1 and 2** - This applies to EAN-13 bar codes starting with either of two 3-digit user-defined prefixes. Set the prefixes using [User-Programmable Supplementals on page 13-16](#).
- **Smart Supplemental Plus User-Programmable 1** - This applies to EAN-13 bar codes starting with any prefix listed previously or the prefix set using [User-Programmable Supplementals on page 13-16](#).
- **Smart Supplemental Plus User-Programmable 1 and 2** - This applies to EAN-13 bar codes starting with any prefix listed previously or one of the two user-defined prefixes set using [User-Programmable Supplementals on page 13-16](#).

✓ **NOTE** To minimize the risk of invalid data transmission, select either to decode or ignore supplemental characters.

## Decode UPC/EAN/JAN Supplementals (continued)

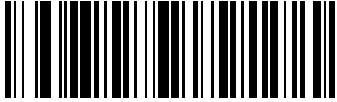

**Decode UPC/EAN/JAN With Supplementals Only**  
(1)



**\*Ignore UPC/EAN/JAN Supplementals**  
(0)

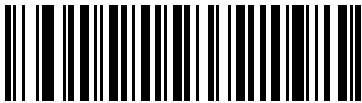

**Autodiscriminate UPC/EAN/JAN with Supplementals**  
(2)



**Enable 378/379 Supplemental Mode**  
(4)

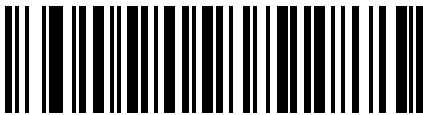

**Enable 978/979 Supplemental Mode**  
(5)

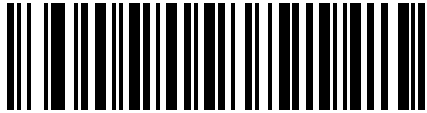

**Enable 977 Supplemental Mode**  
(7)

**Decode UPC/EAN/JAN Supplementals (continued)**

**Enable 414/419/434/439 Supplemental Mode**  
(6)

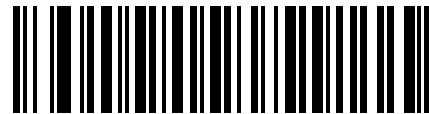

**Enable 491 Supplemental Mode**  
(8)



**Enable Smart Supplemental Mode**  
(3)



**Supplemental User-Programmable Type 1**  
(9)



**Supplemental User-Programmable Type 1 and 2**  
(10)

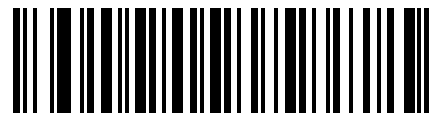

**Smart Supplemental Plus User-Programmable 1**  
(11)



**Smart Supplemental Plus User-Programmable 1 and 2**  
(12)

## User-Programmable Supplementals

### Supplemental 1: Parameter # 579

SSI # F1h 43h

### Supplemental 2: Parameter # 580

SSI # F1h 44h

If you selected a Supplemental User-Programmable option from [Decode UPC/EAN/JAN Supplementals on page 13-13](#), scan **User-Programmable Supplemental 1**, and then scan three bar codes from [Appendix G, Numeric Bar Codes](#) to set the 3-digit prefix. To set a second 3-digit prefix, scan **User-Programmable Supplemental 2**, and then scan three bar codes from [Appendix G, Numeric Bar Codes](#). The default is 000 (zeroes).

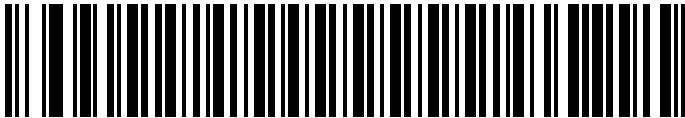

User-Programmable Supplemental 1

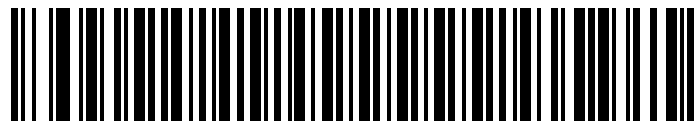

User-Programmable Supplemental 2

## UPC/EAN/JAN Supplemental Redundancy

### Parameter # 80

SSI # 50h

If you selected **Autodiscriminate UPC/EAN/JAN with Supplementals**, this option sets the number of times to decode a symbol without supplementals before transmission. The range is from two to 30. Five or above is recommended when decoding a mix of UPC/EAN/JAN symbols with and without supplementals. The default is 10.

To set a redundancy value, scan the following bar code, and then scan two bar codes from [Appendix G, Numeric Bar Codes](#). Enter a leading zero for single digit numbers. To correct an error or change a selection, scan [Cancel on page G-3](#).

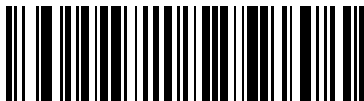

UPC/EAN/JAN Supplemental Redundancy

## UPC/EAN/JAN Supplemental AIM ID Format

### Parameter # 672

### SSI # F1h A0h

If [Transmit Code ID Character on page 5-32](#) is set to **AIM Code ID Character**, scan one of the following bar codes to select an output format when reporting UPC/EAN/JAN bar codes with supplementals:

- **Separate** - Transmit UPC/EAN/JAN with supplementals with separate AIM IDs but one transmission, i.e.,  
]E<0 or 4><data>]E<1 or 2>[supplemental data]
- **Combined** – Transmit UPC/EAN/JAN with supplementals with one AIM ID and one transmission, i.e.,  
]E3<data+supplemental data>
- **Separate Transmissions** - Transmit UPC/EAN/JAN with supplementals with separate AIM IDs and separate transmissions, i.e.,  
]E<0 or 4><data>  
]E<1 or 2>[supplemental data]

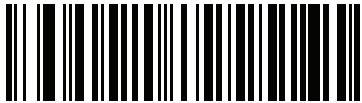

**Separate  
(0)**



**\*Combined  
(1)**



**Separate Transmissions  
(2)**

## Transmit UPC-A Check Digit

### Parameter # 40

#### SSI # 28h

The check digit is the last character of the symbol used to verify the integrity of the data. Scan one of the following bar codes to transmit the bar code data with or without the UPC-A check digit. It is always verified to guarantee the integrity of the data.



**\*Transmit UPC-A Check Digit  
(1)**

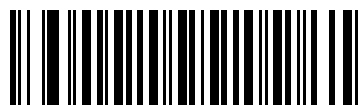

**Do Not Transmit UPC-A Check Digit  
(0)**

## Transmit UPC-E Check Digit

### Parameter # 41

#### SSI # 29h

The check digit is the last character of the symbol used to verify the integrity of the data. Scan one of the following bar codes to transmit the bar code data with or without the UPC-E check digit. It is always verified to guarantee the integrity of the data.



**\*Transmit UPC-E Check Digit  
(1)**

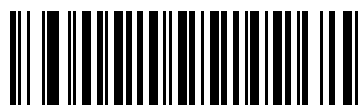

**Do Not Transmit UPC-E Check Digit  
(0)**

## Transmit UPC-E1 Check Digit

Parameter # 42

SSI # 2Ah

The check digit is the last character of the symbol used to verify the integrity of the data. Scan one of the following bar codes to transmit the bar code data with or without the UPC-E1 check digit. It is always verified to guarantee the integrity of the data.

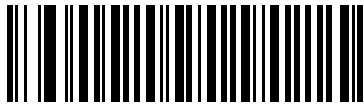

**\*Transmit UPC-E1 Check Digit  
(1)**

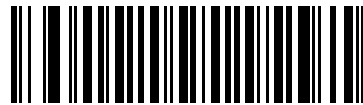

**Do Not Transmit UPC-E1 Check Digit  
(0)**

## Transmit EAN-8 Check Digit

Parameter # 1881

SSI # F8 07 59h

The check digit is the last character of the symbol used to verify the integrity of the data. Scan one of the following barcodes to transmit the barcode data with or without the EAN-8 check digit. It is always verified to guarantee the integrity of the data.



**\*Transmit EAN-8 Check Digit  
(1)**



**Do Not Transmit EAN-8 Check Digit  
(0)**



## Transmit EAN-13 Check Digit

**Parameter # 1882**

**SSI # F8 07 5Ah**

The check digit is the last character of the symbol used to verify the integrity of the data. Scan one of the following barcodes to transmit the barcode data with or without the EAN-13 check digit. It is always verified to guarantee the integrity of the data.

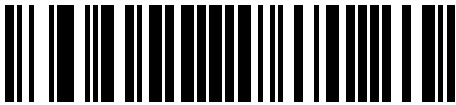

**\*Transmit EAN-13 Check Digit  
(1)**



**Do Not Transmit EAN-13 Check Digit  
(0)**

## UPC-A Preamble

### Parameter # 34

#### SSI # 22h

Preamble characters are part of the UPC symbol, and include Country Code and System Character. Select the appropriate option for transmitting a UPC-A preamble to match the host system:

- Transmit System Character only
- Transmit System Character and Country Code ("0" for USA)
- Transmit no preamble.

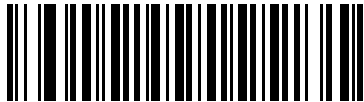

**No Preamble (<DATA>)**  
(0)



**\*System Character**  
**(<SYSTEM CHARACTER> <DATA>)**  
(1)

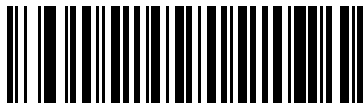

**System Character & Country Code**  
**(< COUNTRY CODE> <SYSTEM CHARACTER> <DATA>)**  
(2)

## UPC-E Preamble

### Parameter # 35

#### SSI # 23h

Preamble characters are part of the UPC symbol, and include Country Code and System Character. Select the appropriate option for transmitting a UPC-E preamble to match the host system:

- Transmit System Character only
- Transmit System Character and Country Code ("0" for USA)
- Transmit no preamble.

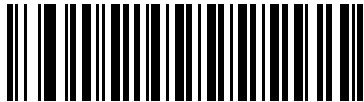

**No Preamble (<DATA>)**  
(0)



**\*System Character**  
**(<SYSTEM CHARACTER> <DATA>)**  
(1)

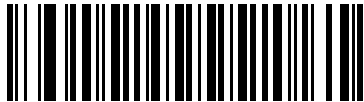

**System Character & Country Code**  
**(< COUNTRY CODE> <SYSTEM CHARACTER> <DATA>)**  
(2)

## UPC-E1 Preamble

### Parameter # 36

### SSI # 24h

Preamble characters are part of the UPC symbol, and include Country Code and System Character. Select the appropriate option for transmitting a UPC-E1 preamble to match the host system:

- Transmit System Character only
- Transmit System Character and Country Code ("0" for USA)
- Transmit no preamble.

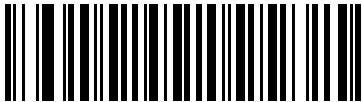

**No Preamble (<DATA>)**  
(0)



**\*System Character**  
**(<SYSTEM CHARACTER> <DATA>)**  
(1)

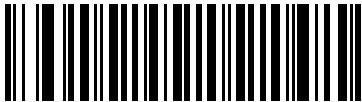

**System Character & Country Code**  
**(< COUNTRY CODE> <SYSTEM CHARACTER> <DATA>)**  
(2)

## Convert UPC-E to UPC-A

### Parameter # 37

#### SSI # 25h

Enable this to convert UPC-E (zero suppressed) decoded data to UPC-A format before transmission. After conversion, the data follows UPC-A format and is affected by UPC-A programming selections (e.g., Preamble, Check Digit).

Disable this to transmit UPC-E decoded data as UPC-E data, without conversion.

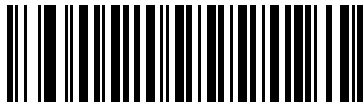

Convert UPC-E to UPC-A (Enable)  
(1)

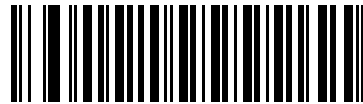

\*Do Not Convert UPC-E to UPC-A (Disable)  
(0)

## Convert UPC-E1 to UPC-A

### Parameter # 38

#### SSI # 26h

Scan **Convert UPC-E1 to UPC-A (Enable)** to convert UPC-E1 decoded data to UPC-A format before transmission. After conversion, the data follows UPC-A format and is affected by UPC-A programming selections (e.g., Preamble, Check Digit).

Scan **Do Not Convert UPC-E1 to UPC-A (Disable)** to transmit UPC-E1 decoded data as UPC-E1 data, without conversion.



Convert UPC-E1 to UPC-A (Enable)  
(1)



\*Do Not Convert UPC-E1 to UPC-A (Disable)  
(0)

## EAN/JAN Zero Extend

### Parameter # 39

### SSI # 27h

Scan **Enable EAN/JAN Zero Extend** to add five leading zeros to decoded EAN-8 symbols to make them compatible in length to EAN-13 symbols. Scan **Disable EAN/JAN Zero Extend** to transmit EAN-8 symbols as is.

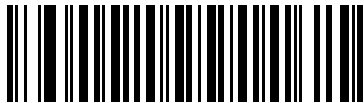

Enable EAN/JAN Zero Extend  
(1)

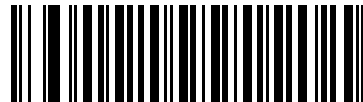

\*Disable EAN/JAN Zero Extend  
(0)

## UCC Coupon Extended Code

### Parameter # 85

### SSI # 55h

Scan **Enable UCC Coupon Extended Code** to decode UPC-A bar codes starting with digit '5', EAN-13 bar codes starting with digit '99', and UPC-A/GS1-128 coupon codes. UPC-A, EAN-13, and GS1-128 must be enabled to use this feature.



Enable UCC Coupon Extended Code  
(1)



\*Disable UCC Coupon Extended Code  
(0)



**NOTE** See [UPC/EAN/JAN Supplemental Redundancy on page 13-16](#) to control autodiscrimination of the GS1-128 portion (right half) of a coupon code.

## Coupon Report

### Parameter # 730

#### SSI # F1h DAh

Scan one of the following bar codes to select the type of coupon format to support.

- **Old Coupon Format** - Support UPC-A/GS1-128 and EAN-13/GS1-128.
- **New Coupon Format** - An interim format to support UPC-A/GS1-DataBar and EAN-13/GS1-DataBar.
- **Autodiscriminate Format** - Support both **Old Coupon Format** and **New Coupon Format**.



Old Coupon Format  
(0)



\*New Coupon Format  
(1)



Autodiscriminate Coupon Format  
(2)

## UPC Reduced Quiet Zone

### Parameter # 1289

#### SSI # F8h 05h 09h

Scan one of the following bar codes to enable or disable decoding UPC bar codes with reduced quiet zones (the margins on either side of the bar code). If you select **Enable**, select a [1D Quiet Zone Level on page 13-78](#).



Enable UPC Reduced Quiet Zone  
(1)

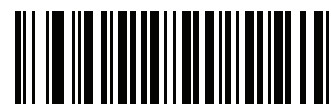

\*Disable UPC Reduced Quiet Zone  
(0)

## Code 128

**Parameter # 8**

**SSI # 08h**

Scan one of the following bar codes to enable or disable Code 128.

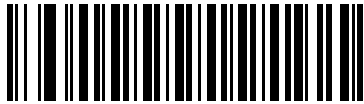

**\*Enable Code 128**  
(1)

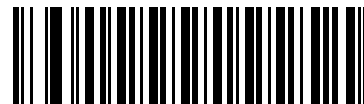

**Disable Code 128**  
(0)

### Set Lengths for Code 128

**L1 = Parameter # 209**

**SSI # D1h**

**L2 = Parameter # 210**

**SSI # D2h**

- ✓ **NOTE** The maximum number of 1D bar code characters readable with scanner depends on the type of symbology, type of characters (i.e., digits or letters), printing density, and quality. For reference, the DS2278 reads 3.1 in wide, 10mil 1D bar codes printed with 1200dpi resolution and 80% contrast.

The length of a code refers to the number of characters (i.e., human readable characters), including check digit(s) the code contains. Set lengths for Code 128 to any length, one or two discrete lengths, or lengths within a specific range. Minimum and maximum length range is from 0 - 80. The default minimum and maximum length range is from 1 - 55.

- ✓ **NOTE** When setting lengths, enter a leading zero for single digit numbers.

Scan one of the following bar codes to select a length option:

- **One Discrete Length** - Decode only Code 128 symbols containing a selected length. Select the length using the bar codes in [Appendix G, Numeric Bar Codes](#). For example, to decode only Code 128 symbols with 14 characters, scan **Code 128 - One Discrete Length**, and then scan **1, 4**. To correct an error or change the selection, scan *Cancel on page G-3*.
- **Two Discrete Lengths** - Decode only Code 128 symbols containing either of two lengths. Select lengths using the bar codes in [Appendix G, Numeric Bar Codes](#). For example, to decode only Code 128 symbols containing either 2 or 14 characters, scan **Code 128 - Two Discrete Lengths**, and then scan **0, 2, 1, 4**. To correct an error or change the selection, scan *Cancel on page G-3*.
- **Length Within Range** - Decode Code 128 symbols with a specific length range. Select lengths using the bar codes in [Appendix G, Numeric Bar Codes](#). For example, to decode Code 128 symbols containing between 4 and 12 characters, scan **Code 128 - Length Within Range**, and then scan **0, 4, 1, 2**. To correct an error or change the selection, scan *Cancel on page G-3*.



### Set Lengths for Code 128 (continued)

- **Any Length** - Decode Code 128 symbols containing any number of characters within the scanner's capability.

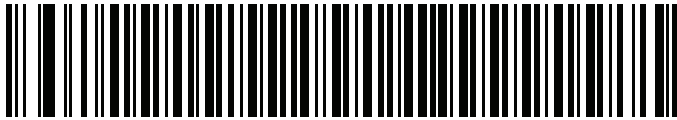

Code 128 - One Discrete Length



Code 128 - Two Discrete Lengths

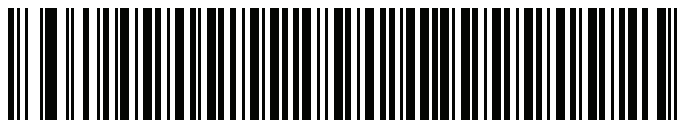

\*Code 128 - Length Within Range  
(Default: 1 - 55)

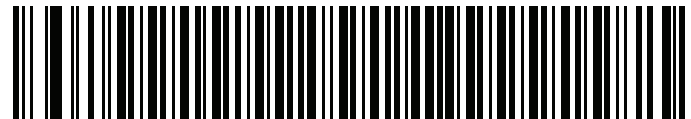

Code 128 - Any Length

### GS1-128 (formerly UCC/EAN-128)

Parameter # 14

SSI # 0Eh

Scan one of the following bar codes to enable or disable GS1-128.

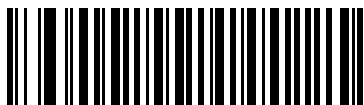

\*Enable GS1-128  
(1)



Disable GS1-128  
(0)

**ISBT 128****Parameter # 84****SSI # 54h**

ISBT 128 is a variant of Code 128 used in the blood bank industry. Scan one of the following bar codes to enable or disable ISBT 128.



**Enable ISBT 128**  
**(1)**



**\*Disable ISBT 128**  
**(0)**

## ISBT Concatenation

### Parameter # 577

#### SSI # F1h 41h

Select an option for concatenating pairs of ISBT code types:

- **Enable ISBT Concatenation** - There must be two ISBT codes in order for the scanner to decode and perform concatenation. The scanner does not decode single ISBT symbols.
- **Disable ISBT Concatenation** - The scanner does not concatenate pairs of ISBT codes it encounters.
- **Autodiscriminate ISBT Concatenation** - The scanner decodes and concatenates pairs of ISBT codes immediately. If only a single ISBT symbol is present, the scanner must decode the symbol the number of times set via [ISBT Concatenation Redundancy on page 13-31](#) before transmitting its data to confirm that there is no additional ISBT symbol.



**Enable ISBT Concatenation  
(1)**

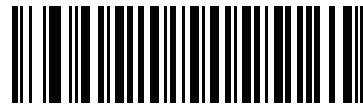

**\*Disable ISBT Concatenation  
(0)**



**Autodiscriminate ISBT Concatenation  
(2)**

## Check ISBT Table

### Parameter # 578

#### SSI # F1h 42h

The ISBT specification includes a table that lists several types of ISBT bar codes that are commonly used in pairs. If you set **ISBT Concatenation** to **Enable**, enable **Check ISBT Table** to concatenate only those pairs found in this table. Other types of ISBT codes are not concatenated.



\*Enable Check ISBT Table  
(1)



Disable Check ISBT Table  
(0)

## ISBT Concatenation Redundancy

### Parameter # 223

#### SSI # DFh

If [ISBT Concatenation on page 13-30](#) is set to **Autodiscriminate ISBT Concatenation**, you can set the number of times the scanner must decode an ISBT symbol before determining that there is no additional symbol. To do so, scan **ISBT Concatenation Redundancy** below and then scan bar codes in [Appendix G, Numeric Bar Codes](#) to set a value between 2 and 20. Enter a leading zero for single digit numbers. To correct an error or change a selection, scan *Cancel on page G-3*. The default is 10.



ISBT Concatenation Redundancy

## Code 128 <FNC4>

### Parameter # 1254

### SSI # F8h 04h E6h

This feature applies to Code 128 bar codes with an embedded <FNC4> character. Select **Ignore Code 128 <FNC4>** to strip the <FNC4> character from the decode data. The remaining characters are sent to the host unchanged. When disabled, the <FNC4> character is processed normally as per Code 128 standard.



\*Honor Code 128 <FNC4>  
(0)



Ignore Code 128 <FNC4>  
(1)

## Code 128 Security Level

### Parameter # 751

### SSI # F1h EFh

Code 128 bar codes are vulnerable to misdecodes, particularly when Code 128 Lengths is set to **Any Length**. The scanner offers four levels of decode security for Code 128 bar codes. There is an inverse relationship between security and scanner aggressiveness. Increasing the level of security can reduce scanning aggressiveness, so select only the level of security necessary.

- **Code 128 Security Level 0** - The scanner operates in its most aggressive state, while providing sufficient security in decoding most in-spec bar codes.
- **Code 128 Security Level 1** - This option eliminates most misdecodes while maintaining reasonable aggressiveness.
- **Code 128 Security Level 2** - This option applies greater bar code security requirements if **Security Level 1** fails to eliminate misdecodes.
- **Code 128 Security Level 3** - If you selected **Security Level 2**, and misdecodes still occur, select this security level to apply the highest safety requirements.

✓ **NOTE** Selecting this option is an extreme measure against mis-decoding severely out-of-spec bar codes, and significantly impairs the decoding ability of the scanner. If this level of security is required, try to improve the quality of the bar codes.

## Code 128 Security Level (continued)



Code 128 Security Level 0  
(0)

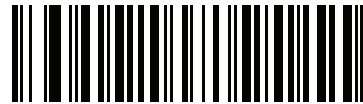

\*Code 128 Security Level 1  
(1)



Code 128 Security Level 2  
(2)



Code 128 Security Level 3  
(3)

## Code 128 Reduced Quiet Zone

Parameter # 1208

SSI # F8h 04h B8h

Scan one of the following bar codes to enable or disable decoding Code 128 bar codes with reduced quiet zones (the margins on either side of the bar code). If you select **Enable**, select a [1D Quiet Zone Level on page 13-78](#).



Enable Code 128 Reduced Quiet Zone  
(1)



\*Disable Code 128 Reduced Quiet Zone  
(0)

---

## Code 39

**Parameter # 0**

**SSI # 00h**

Scan one of the following bar codes to enable or disable Code 39.

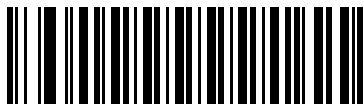

**\*Enable Code 39  
(1)**



**Disable Code 39  
(0)**

## Trioptic Code 39

**Parameter # 13**

**SSI # 0Dh**

Trioptic Code 39 is a variant of Code 39 used in the marking of computer tape cartridges. Trioptic Code 39 symbols always contain six characters. Scan one of the following bar codes to enable or disable Trioptic Code 39.

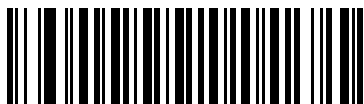

**Enable Trioptic Code 39  
(1)**



**\*Disable Trioptic Code 39  
(0)**

✓ **NOTE** You cannot enable Trioptic Code 39 and Code 39 Full ASCII simultaneously.

## Convert Code 39 to Code 32

### Parameter # 86

### SSI # 56h

Code 32 is a variant of Code 39 used by the Italian pharmaceutical industry. Scan one of the following bar codes to enable or disable converting Code 39 to Code 32.

✓ **NOTE** Code 39 must be enabled for this parameter to function.



**Enable Convert Code 39 to Code 32**  
(1)

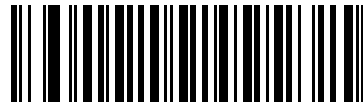

**\*Disable Convert Code 39 to Code 32**  
(0)

## Code 32 Prefix

### Parameter # 231

### SSI # E7h

Scan one of the following bar codes to enable or disable adding the prefix character “A” to all Code 32 bar codes.

✓ **NOTE** Convert Code 39 to Code 32 must be enabled for this parameter to function.

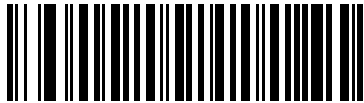

**Enable Code 32 Prefix**  
(1)



**\*Disable Code 32 Prefix**  
(0)



## Set Lengths for Code 39

**L1 = Parameter # 18**

**SSI # 12h**

**L2 = Parameter # 19**

**SSI # 13h**

- ✓ **NOTE** The maximum number of 1D bar code characters readable with scanner depends on the type of symbology, type of characters (i.e., digits or letters), printing density, and quality. For reference, the DS2278 reads 3.1 in wide, 10mil 1D bar codes printed with 1200dpi resolution and 80% contrast.

The length of a code refers to the number of characters (i.e., human readable characters), including check digit(s) the code contains. Set lengths for Code 39 to any length, one or two discrete lengths, or lengths within a specific range. If Code 39 Full ASCII is enabled, **Length Within Range** or **Any Length** are the preferred options. Minimum and maximum length range is from 0 - 80. The default minimum and maximum length range is from 1 - 55.

- ✓ **NOTE** When setting lengths, enter a leading zero for single digit numbers.

Scan one of the following bar codes to select a length option:

- **One Discrete Length** - Decode only Code 39 symbols containing a selected length. Select the length using the bar codes in [Appendix G, Numeric Bar Codes](#). For example, to decode only Code 39 symbols with 14 characters, scan **Code 39 - One Discrete Length**, and then scan **1, 4**. To correct an error or change the selection, scan *Cancel on page G-3*.
- **Two Discrete Lengths** - Decode only Code 39 symbols containing either of two lengths. Select lengths using the bar codes in [Appendix G, Numeric Bar Codes](#). For example, to decode only Code 39 symbols containing either 2 or 14 characters, scan **Code 39 - Two Discrete Lengths**, and then scan **0, 2, 1, 4**. To correct an error or change the selection, scan *Cancel on page G-3*.
- **Length Within Range** - Decode Code 39 symbols with a specific length range. Select lengths using the bar codes in [Appendix G, Numeric Bar Codes](#). For example, to decode Code 39 symbols containing between 4 and 12 characters, scan **Code 39 - Length Within Range**, and then scan **0, 4, 1, 2**. To correct an error or change the selection, scan *Cancel on page G-3*.
- **Any Length** - Decode Code 39 symbols containing any number of characters within the scanner's capability.

## Set Lengths for Code 39 (continued)



Code 39 - One Discrete Length

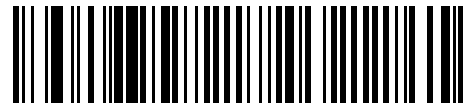

Code 39 - Two Discrete Lengths



\*Code 39 - Length Within Range  
(Default: 1 - 55)



Code 39 - Any Length

## Code 39 Check Digit Verification

### Parameter # 48

### SSI # 30h

Scan **Enable Code 39 Check Digit** to check the integrity of all Code 39 symbols to verify that the data complies with specified check digit algorithm. Only Code 39 symbols which include a modulo 43 check digit are decoded. Enable this feature if the Code 39 symbols contain a Modulo 43 check digit.

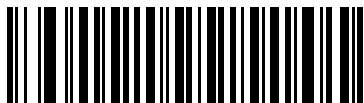

Enable Code 39 Check Digit  
(1)

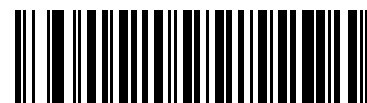

\*Disable Code 39 Check Digit  
(0)

## Transmit Code 39 Check Digit

Parameter # 43

SSI # 2Bh

Scan one of the following bar codes to transmit Code 39 data with or without the check digit.



Transmit Code 39 Check Digit (Enable)  
(1)



\*Do Not Transmit Code 39 Check Digit (Disable)  
(0)

✓ **NOTE** *Code 39 Check Digit Verification* must be enabled for this parameter to function.

## Code 39 Full ASCII Conversion

Parameter # 17

SSI # 11h

Code 39 Full ASCII is a variant of Code 39 which pairs characters to encode the full ASCII character set. Scan one of the following bar codes to enable or disable Code 39 Full ASCII.



Enable Code 39 Full ASCII  
(1)



\*Disable Code 39 Full ASCII  
(0)

✓ **NOTE** You cannot enable Trioptic Code 39 and Code 39 Full ASCII simultaneously.

Code 39 Full ASCII to Full ASCII Correlation is host-dependent, and is therefore described in the ASCII character set table for the appropriate interface. See [Table I-1 on page I-1](#).

## Code 39 Security Level

### Parameter # 750

#### SSI # F1h EEh

The scanner offers four levels of decode security for Code 39 bar codes. There is an inverse relationship between security and scanner aggressiveness. Increasing the level of security can reduce scanning aggressiveness, so select only the level of security necessary.

- **Code 39 Security Level 0:** The scanner operates in its most aggressive state, while providing sufficient security in decoding most in-spec bar codes.
- **Code 39 Security Level 1:** This default setting eliminates most misdecodes.
- **Code 39 Security Level 2:** This option applies greater bar code security requirements if **Security Level 1** fails to eliminate misdecodes.
- **Code 39 Level 3:** If you selected **Security Level 2**, and misdecodes still occur, select this security level to apply the highest safety requirements.

✓ **NOTE** Selecting this option is an extreme measure against mis-decoding severely out-of-spec bar codes, and significantly impairs the decoding ability of the scanner. If this level of security is required, try to improve the quality of the bar codes.

## Code 39 Security Level (continued)



**Code 39 Security Level 0  
(0)**



**\*Code 39 Security Level 1  
(1)**



**Code 39 Security Level 2  
(2)**



**Code 39 Security Level 3  
(3)**

## Code 39 Reduced Quiet Zone

Parameter # 1209

SSI # F8h 04h B9h

Scan one of the following bar codes to enable or disable decoding Code 39 bar codes with reduced quiet zones (the margins on either side of the bar code). If you select **Enable**, select a [1D Quiet Zone Level on page 13-78](#).



Enable Code 39 Reduced Quiet Zone  
(1)



\*Disable Code 39 Reduced Quiet Zone  
(0)

---

## Code 93

Parameter # 9

SSI # 09h

Scan one of the following bar codes to enable or disable Code 93.

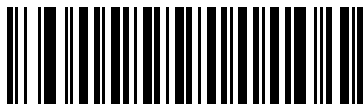

\*Enable Code 93  
(1)



Disable Code 93  
(0)

---

## Code 93 (continued)

### Set Lengths for Code 93

**L1 = Parameter # 26**

**SSI # 1Ah**

**L2 = Parameter # 27**

**SSI # 1Bh**

- ✓ **NOTE** The maximum number of 1D bar code characters readable with scanner depends on the type of symbology, type of characters (i.e., digits or letters), printing density, and quality. For reference, the DS2278 reads 3.1 in wide, 10mil 1D bar codes printed with 1200dpi resolution and 80% contrast.

The length of a code refers to the number of characters (i.e., human readable characters), including check digit(s) the code contains. Set lengths for Code 93 to any length, one or two discrete lengths, or lengths within a specific range. Minimum and maximum length range is from 0 - 55. The default minimum and maximum length range is from 1 - 55.

- ✓ **NOTE** When setting lengths, enter a leading zero for single digit numbers.

Scan one of the following bar codes to select a length option:

- **One Discrete Length** - Decode only Code 93 symbols containing a selected length. Select the length using the bar codes in [Appendix G, Numeric Bar Codes](#). For example, to decode only Code 93 symbols with 14 characters, scan **Code 93 - One Discrete Length**, and then scan **1, 4**. To correct an error or change the selection, scan *Cancel on page G-3*.
- **Two Discrete Lengths** - Decode only Code 93 symbols containing either of two lengths. Select lengths using the bar codes in [Appendix G, Numeric Bar Codes](#). For example, to decode only Code 93 symbols containing either 2 or 14 characters, scan **Code 93 - Two Discrete Lengths**, and then scan **0, 2, 1, 4**. To correct an error or change the selection, scan *Cancel on page G-3*.
- **Length Within Range** - Decode Code 93 symbols with a specific length range. Select lengths using the bar codes in [Appendix G, Numeric Bar Codes](#). For example, to decode Code 93 symbols containing between 4 and 12 characters, scan **Code 93 - Length Within Range**, and then scan **0, 4, 1, 2**. To correct an error or change the selection, scan *Cancel on page G-3*.
- **Any Length** - Decode Code 93 symbols containing any number of characters within the scanner's capability.

### Set Lengths for Code 93 (continued)



Code 93 - One Discrete Length



Code 93 - Two Discrete Lengths



\*Code 93 - Length Within Range  
(Default: 1 - 55)



Code 93 - Any Length



## Code 11

### Parameter # 10

### SSI # 0Ah

Scan one of the following bar codes to enable or disable Code 11

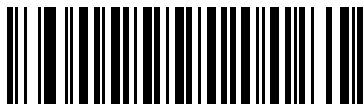

Enable Code 11  
(1)



\*Disable Code 11  
(0)

### Set Lengths for Code 11

#### L1 = Parameter # 28

#### SSI # 1Ch

#### L2 = Parameter # 29

#### SSI # 1Dh

- ✓ **NOTE** The maximum number of 1D bar code characters readable with scanner depends on the type of symbology, type of characters (i.e., digits or letters), printing density, and quality. For reference, the DS2278 reads 3.1 in wide, 10mil 1D bar codes printed with 1200dpi resolution and 80% contrast.

The length of a code refers to the number of characters (i.e., human readable characters), including check digit(s) the code contains. Set lengths for Code 11 to any length, one or two discrete lengths, or lengths within a specific range. Minimum and maximum length range is from 0 - 55. The default minimum and maximum length range is from 4 - 55.

- ✓ **NOTE** When setting lengths, enter a leading zero for single digit numbers.

Scan one of the following bar codes to select a length option:

- **One Discrete Length** - Decode only Code 11 symbols containing a selected length. Select the length using the bar codes in [Appendix G, Numeric Bar Codes](#). For example, to decode only Code 11 symbols with 14 characters, scan **Code 11 - One Discrete Length**, and then scan **1, 4**. To correct an error or change the selection, scan *Cancel on page G-3*.

## Set Lengths for Code 11 (continued)

- **Two Discrete Lengths** - Decode only Code 11 symbols containing either of two lengths. Select lengths using the bar codes in [Appendix G, Numeric Bar Codes](#). For example, to decode only Code 11 symbols containing either 2 or 14 characters, scan **Code 11 - Two Discrete Lengths**, and then scan **0, 2, 1, 4**. To correct an error or change the selection, scan *Cancel on page G-3*.
- **Length Within Range** - Decode Code 11 symbols with a specific length range. Select lengths using the bar codes in [Appendix G, Numeric Bar Codes](#). For example, to decode Code 11 symbols containing between 4 and 12 characters, scan **Code 11 - Length Within Range**, and then scan **0, 4, 1, 2**. To correct an error or change the selection, scan *Cancel on page G-3*.
- **Any Length** - Decode Code 11 symbols containing any number of characters within the scanner's capability.

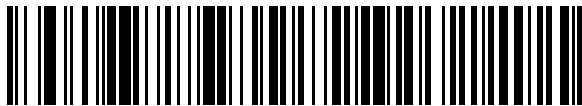

Code 11 - One Discrete Length

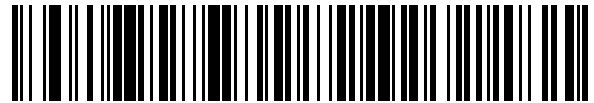

Code 11 - Two Discrete Lengths

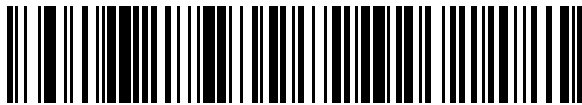

\*Code 11 - Length Within Range  
(Default: 4 - 55)

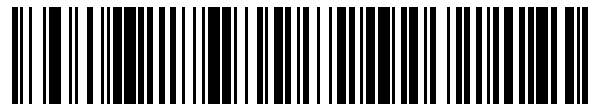

Code 11 - Any Length

## Code 11 Check Digit Verification

### Parameter # 52

#### SSI # 34h

This feature allows the scanner to check the integrity of all Code 11 symbols to verify that the data complies with the specified check digit algorithm.

Scan one of the following bar codes to specify the number of check digits encoded in the Code 11 symbols, or to disable this feature.



**\*Disable  
(0)**

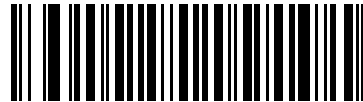

**One Check Digit  
(1)**

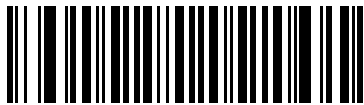

**Two Check Digits  
(2)**

## Transmit Code 11 Check Digits

### Parameter # 47

#### SSI # 2Fh

Scan one of the following bar codes to select whether or not to transmit the Code 11 check digit(s).

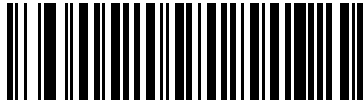

Transmit Code 11 Check Digit(s) (Enable)  
(1)

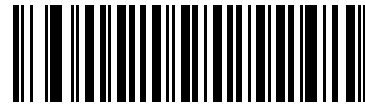

\*Do Not Transmit Code 11 Check Digit(s) (Disable)  
(0)

✓ *NOTE* Code 11 Check Digit Verification must be enabled for this parameter to function.

---

## Interleaved 2 of 5 (ITF/I 2 of 5)

### Parameter # 6

#### SSI # 06h

Scan one of the following bar codes to enable or disable I 2 of 5.

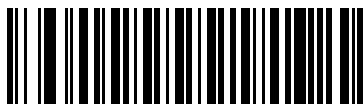

\*Enable I 2 of 5  
(1)

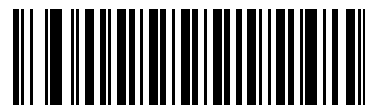

Disable I 2 of 5  
(0)

## Set Lengths for Interleaved 2 of 5

**L1 = Parameter # 22**

**SSI # 16h**

**L2 = Parameter # 23**

**SSI # 17h**

- ✓ **NOTE** The maximum number of 1D bar code characters readable with scanner depends on the type of symbology, type of characters (i.e., digits or letters), printing density, and quality. For reference, the DS2278 reads 3.1 in wide, 10mil 1D bar codes printed with 1200dpi resolution and 80% contrast.

The length of a code refers to the number of characters (i.e., human readable characters), including check digit(s) the code contains. Set lengths for I 2 of 5 to any length, one or two discrete lengths, or lengths within a specific range. Minimum and maximum length range is from 0 - 55. The default minimum and maximum length range is from 6 - 55.

- ✓ **NOTE** When setting lengths, enter a leading zero for single digit numbers.

Scan one of the following bar codes to select a length option:

- **One Discrete Length** - Decode only I 2 of 5 symbols containing a selected length. Select the length using the bar codes in [Appendix G, Numeric Bar Codes](#). For example, to decode only I 2 of 5 symbols with 14 characters, scan **I 2 of 5 - One Discrete Length**, and then scan **1, 4**. To correct an error or change the selection, scan *Cancel on page G-3*.
- **Two Discrete Lengths** - Decode only I 2 of 5 symbols containing either of two lengths. Select lengths using the bar codes in [Appendix G, Numeric Bar Codes](#). For example, to decode only I 2 of 5 symbols containing either 2 or 14 characters, scan **I 2 of 5 - Two Discrete Lengths**, and then scan **0, 2, 1, 4**. To correct an error or change the selection, scan *Cancel on page G-3*.
- **Length Within Range** - Decode I 2 of 5 symbols with a specific length range. Select lengths using the bar codes in [Appendix G, Numeric Bar Codes](#). For example, to decode I 2 of 5 symbols containing between 4 and 12 characters, scan **I 2 of 5 - Length Within Range**, and then scan **0, 4, 1, 2**. To correct an error or change the selection, scan *Cancel on page G-3*.
- **Any Length** - Decode I 2 of 5 symbols containing any number of characters within the scanner's capability.

- ✓ **NOTE** Due to the construction of the I 2 of 5 symbology, it is possible for a scan line covering only a portion of the code to transmit as a complete scan, yielding less data than is encoded in the bar code. To prevent this, select specific lengths (I 2 of 5 - One Discrete Length, Two Discrete Lengths) for I 2 of 5 applications, or increase the [I 2 of 5 Security Level on page 13-53](#).

### Set Lengths for Interleaved 2 of 5 (continued)



**I 2 of 5 - One Discrete Length**

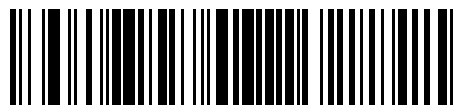

**I 2 of 5 - Two Discrete Lengths**



**\*I 2 of 5 - Length Within Range  
(Default: 6 - 55)**

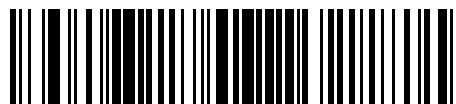

**I 2 of 5 - Any Length**

## I 2 of 5 Check Digit Verification

### Parameter # 49

#### SSI # 31h

Scan one of the following bar codes to check the integrity of all I 2 of 5 symbols to verify the data complies with either the specified Uniform Symbology Specification (USS), or the Optical Product Code Council (OPCC) check digit algorithm.



**\*Disable  
(0)**



**USS Check Digit  
(1)**



**OPCC Check Digit  
(2)**

## Transmit I 2 of 5 Check Digit

Parameter # 44

SSI # 2Ch

Scan one of the following bar codes to transmit I 2 of 5 data with or without the check digit.



Transmit I 2 of 5 Check Digit (Enable)  
(1)



\*Do Not Transmit I 2 of 5 Check Digit (Disable)  
(0)

## Convert I 2 of 5 to EAN-13

Parameter # 82

SSI # 52h

Scan **Convert I 2 of 5 to EAN-13 (Enable)** to convert 14-character I 2 of 5 codes to EAN-13, and transmit to the host as EAN-13. To accomplish this, the I 2 of 5 code must be enabled, and the code must have a leading zero and a valid EAN-13 check digit.

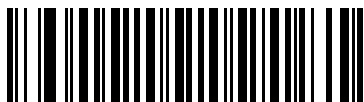

Convert I 2 of 5 to EAN-13 (Enable)  
(1)



\*Do Not Convert I 2 of 5 to EAN-13 (Disable)  
(0)



## Febraban

### Parameter # 1750

### SSI # F8h 06h D6h

Febraban is an I 2 of 5 bar code of length 44 that requires special check characters to be inserted in the transmitted data stream. When enabled, the I 2 of 5 internal check digit calculation and transmission is disabled. When disabled, all I 2 of 5 functionality works as usual.

#### *Recommendations for Length Setting*

I 2 of 5 Length 1: Larger of the fixed length and the FEBRABAN length (==44).

I 2 of 5 Length 2: Smaller of the fixed length and the FEBRABAN length (==44).



**Enable Febraban  
(1)**



**\*Disable Febraban  
(0)**

## I 2 of 5 Security Level

### Parameter # 1121

### SSI # F8h 04h 61h

I 2 of 5 bar codes are vulnerable to misdecodes, particularly when I 2 of 5 Lengths is set to **Any Length**. The scanner offers four levels of decode security for I 2 of 5 bar codes. There is an inverse relationship between security and scanner aggressiveness. Increasing the level of security can reduce scanning aggressiveness, so select only the level of security necessary.

- **I 2 of 5 Security Level 0:** The scanner operates in its most aggressive state, while providing sufficient security in decoding most in-spec bar codes.
- **I 2 of 5 Security Level 1:** A bar code must be successfully read twice, and satisfy certain safety requirements before being decoded. This default setting eliminates most misdecodes.
- **I 2 of 5 Security Level 2:** This option applies greater bar code security requirements if **Security Level 1** fails to eliminate misdecodes.
- **I 2 of 5 Security Level 3:** If you selected **Security Level 2**, and misdecodes still occur, select this security level. The highest safety requirements are applied. A bar code must be successfully read three times before being decoded.

✓ **NOTE** Selecting this option is an extreme measure against mis-decoding severely out-of-spec bar codes, and significantly impairs the decoding ability of the scanner. If this level of security is required, try to improve the quality of the bar codes.

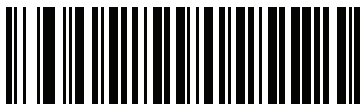

I 2 of 5 Security Level 0  
(0)

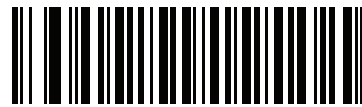

\*I 2 of 5 Security Level 1  
(1)



I 2 of 5 Security Level 2  
(2)

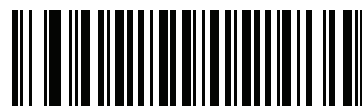

I 2 of 5 Security Level 3  
(3)

## I 2 of 5 Reduced Quiet Zone

Parameter # 1210

SSI # F8h 04h BAh

Scan one of the following bar codes to enable or disable decoding I 2 of 5 bar codes with reduced quiet zones (the margins on either side of the bar code). If you select **Enable**, select a [1D Quiet Zone Level on page 13-78](#).



Enable I 2 of 5 Reduced Quiet Zone  
(1)

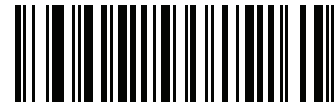

\*Disable I 2 of 5 Reduced Quiet Zone  
(0)

---

## Discrete 2 of 5 (DTF/D 2 of 5)

Parameter # 5

SSI # 05h

Scan one of the following bar codes to enable or disable D 2 of 5.

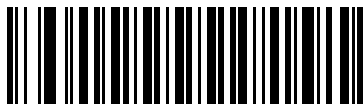

Enable D 2 of 5  
(1)



\*Disable D 2 of 5  
(0)

## Set Lengths for Discrete 2 of 5

**L1 = Parameter # 20**

**SSI # 14h**

**L2 = Parameter # 21**

**SSI # 15h**

- ✓ **NOTE** The maximum number of 1D bar code characters readable with scanner depends on the type of symbology, type of characters (i.e., digits or letters), printing density, and quality. For reference, the DS2278 reads 3.1 in wide, 10mil 1D bar codes printed with 1200dpi resolution and 80% contrast.

The length of a code refers to the number of characters (i.e., human readable characters), including check digit(s) the code contains. Set lengths for D 2 of 5 to any length, one or two discrete lengths, or lengths within a specific range. Minimum and maximum length range is from 0 - 55. The default minimum and maximum length range is from 1 - 55.

- ✓ **NOTE** When setting lengths, enter a leading zero for single digit numbers.

Scan one of the following bar codes to select a length option:

- **One Discrete Length** - Decode only D 2 of 5 symbols containing a selected length. Select the length using the bar codes in [Appendix G, Numeric Bar Codes](#). For example, to decode only D 2 of 5 symbols with 14 characters, scan **D 2 of 5 - One Discrete Length**, and then scan **1, 4**. To correct an error or change the selection, scan *Cancel on page G-3*.
- **Two Discrete Lengths** - Decode only D 2 of 5 symbols containing either of two lengths. Select lengths using the bar codes in [Appendix G, Numeric Bar Codes](#). For example, to decode only D 2 of 5 symbols containing either 2 or 14 characters, scan **D 2 of 5 - Two Discrete Lengths**, and then scan **0, 2, 1, 4**. To correct an error or change the selection, scan *Cancel on page G-3*.
- **Length Within Range** - Decode D 2 of 5 symbols with a specific length range. Select lengths using the bar codes in [Appendix G, Numeric Bar Codes](#). For example, to decode D 2 of 5 symbols containing between 4 and 12 characters, scan **D 2 of 5 - Length Within Range**, and then scan **0, 4, 1, 2**. To correct an error or change the selection, scan *Cancel on page G-3*.
- **Any Length** - Decode D 2 of 5 symbols containing any number of characters within the scanner's capability.

- ✓ **NOTE** Due to the construction of the D 2 of 5 symbology, it is possible for a scan line covering only a portion of the code to transmit as a complete scan, yielding less data than is encoded in the bar code. To prevent this, select specific lengths (D 2 of 5 - One Discrete Length, Two Discrete Lengths) for D 2 of 5 applications.

## Set Lengths for Discrete 2 of 5 (continued)



**D 2 of 5 - One Discrete Length**

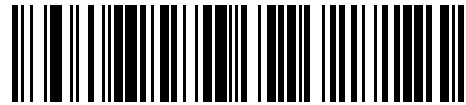

**D 2 of 5 - Two Discrete Lengths**



**\*D 2 of 5 - Length Within Range  
(Default: 1 - 55)**



**D 2 of 5 - Any Length**

---

## Codabar (NW - 7)

**Parameter # 7**

**SSI # 07h**

Scan one of the following bar codes to enable or disable Codabar.

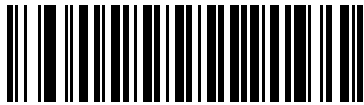

**\*Enable Codabar  
(1)**



**Disable Codabar  
(0)**

### Set Lengths for Codabar

**L1 = Parameter # 24**

**SSI # 18h**

**L2 = Parameter # 25**

**SSI # 19h**

- ✓ **NOTE** The maximum number of 1D bar code characters readable with scanner depends on the type of symbology, type of characters (i.e., digits or letters), printing density, and quality. For reference, the DS2278 reads 3.1 in wide, 10mil 1D bar codes printed with 1200dpi resolution and 80% contrast.

The length of a code refers to the number of characters (i.e., human readable characters), including check digit(s) the code contains. Set lengths for Codabar to any length, one or two discrete lengths, or lengths within a specific range. Minimum and maximum length range is from 0 - 55. The default minimum and maximum length range is from 4 - 55.

- ✓ **NOTE** When setting lengths, enter a leading zero for single digit numbers.

## Set Lengths for Codabar (continued)

Scan one of the following bar codes to select a length option:

- **One Discrete Length** - Decode only Codabar symbols containing a selected length. Select the length using the bar codes in [Appendix G, Numeric Bar Codes](#). For example, to decode only Codabar symbols with 14 characters, scan **Codabar - One Discrete Length**, and then scan **1, 4**. To correct an error or change the selection, scan *Cancel on page G-3*.
- **Two Discrete Lengths** - Decode only Codabar symbols containing either of two lengths. Select lengths using the bar codes in [Appendix G, Numeric Bar Codes](#). For example, to decode only Codabar symbols containing either 2 or 14 characters, scan **Codabar - Two Discrete Lengths**, and then scan **0, 2, 1, 4**. To correct an error or change the selection, scan *Cancel on page G-3*.
- **Length Within Range** - Decode Codabar symbols with a specific length range. Select lengths using the bar codes in [Appendix G, Numeric Bar Codes](#). For example, to decode Codabar symbols containing between 4 and 12 characters, scan **Codabar - Length Within Range**, and then scan **0, 4, 1, 2**. To correct an error or change the selection, scan *Cancel on page G-3*.
- **Any Length** - Decode Codabar symbols containing any number of characters within the scanner's capability.



**Codabar - One Discrete Length**



**Codabar - Two Discrete Lengths**



**\*Codabar - Length Within Range**  
(Default: 4 - 55)



**Codabar - Any Length**

## CLSI Editing

### Parameter # 54

#### SSI # 36h

Scan **Enable CLSI Editing** to strip the start and stop characters and insert a space after the first, fifth, and tenth characters of a 14-character Codabar symbol if the host system requires this data format.

✓ **NOTE** Symbol length does not include start and stop characters.

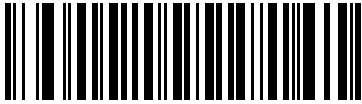

Enable CLSI Editing  
(1)

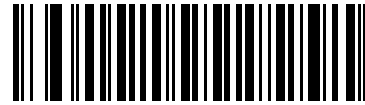

\*Disable CLSI Editing  
(0)

## NOTIS Editing

### Parameter # 55

#### SSI # 37h

Scan **Enable NOTIS Editing** to strip the start and stop characters from a decoded Codabar symbol if the host system requires this data format.

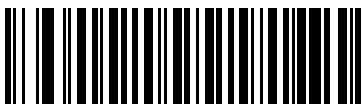

Enable NOTIS Editing  
(1)

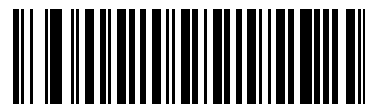

\*Disable NOTIS Editing  
(0)



## Codabar Upper or Lower Case Start/Stop Characters

**Parameter # 855**

**SSI # F2h 57h**

Scan one of the following bar codes to select whether to transmit upper case or lower case Codabar start/stop characters.



**Lower Case  
(1)**



**\*Upper Case  
(0)**

## Codabar Mod 16 Check Digit Verification

**Parameter # 1784**

**SSI # F8h 06h F8h**

Enable this feature to check the Codabar Mod 16 Check Digit to verify that the data complies with the specified check digit algorithm.

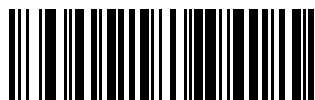

**Enable Codabar Mod 16 Check Digit  
(1)**



**\*Disable Codabar Mod 16 Check Digit  
(0)**

## Transmit Codabar Check Digit

Parameter # 704

SSI # F1h C0h

Scan one of the following barcodes to select whether or not to transmit the Codabar check digit(s).

✓ **NOTE** *Codabar Mod 16 Check Digit Verification* must be enabled for this parameter to function.

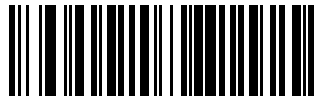

Enable Codabar Check Digit Transmission  
(1)



\*Disable Codabar Check Digit Transmission  
(0)

---

## MSI

Parameter # 11

SSI # 0Bh

Scan one of the following bar codes to enable or disable MSI.

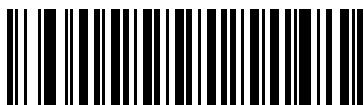

Enable MSI  
(1)



\*Disable MSI  
(0)

## Set Lengths for MSI

**L1 = Parameter # 30**  
**SSI # 1Eh**

**L2 = Parameter # 31**  
**SSI # 1Fh**

- ✓ **NOTE** The maximum number of 1D bar code characters readable with scanner depends on the type of symbology, type of characters (i.e., digits or letters), printing density, and quality. For reference, the DS2278 reads 3.1 in wide, 10mil 1D bar codes printed with 1200dpi resolution and 80% contrast.

The length of a code refers to the number of characters (i.e., human readable characters), including check digit(s) the code contains. Set lengths for MSI to any length, one or two discrete lengths, or lengths within a specific range. Minimum and maximum length range is from 0 - 55. The default minimum and maximum length range is from 4 - 55.

- ✓ **NOTE** When setting lengths, enter a leading zero for single digit numbers.

Scan one of the following bar codes to select a length option:

- **One Discrete Length** - Decode only MSI symbols containing a selected length. Select the length using the bar codes in [Appendix G, Numeric Bar Codes](#). For example, to decode only MSI symbols with 14 characters, scan **MSI - One Discrete Length**, and then scan **1, 4**. To correct an error or change the selection, scan *Cancel on page G-3*.
- **Two Discrete Lengths** - Decode only MSI symbols containing either of two lengths. Select lengths using the bar codes in [Appendix G, Numeric Bar Codes](#). For example, to decode only MSI symbols containing either 2 or 14 characters, scan **MSI - Two Discrete Lengths**, and then scan **0, 2, 1, 4**. To correct an error or change the selection, scan *Cancel on page G-3*.
- **Length Within Range** - Decode MSI symbols with a specific length range. Select lengths using the bar codes in [Appendix G, Numeric Bar Codes](#). For example, to decode MSI symbols containing between 4 and 12 characters, scan **MSI - Length Within Range**, and then scan **0, 4, 1, 2**. To correct an error or change the selection, scan *Cancel on page G-3*.
- **Any Length** - Decode MSI symbols containing any number of characters within the scanner's capability.

- ✓ **NOTE** Due to the construction of the MSI symbology, it is possible for a scan line covering only a portion of the code to transmit as a complete scan, yielding less data than is encoded in the bar code. To prevent this, select specific lengths (**MSI - One Discrete Length, Two Discrete Lengths**) for MSI applications.

## Set Lengths for MSI (continued)



**MSI - One Discrete Length**

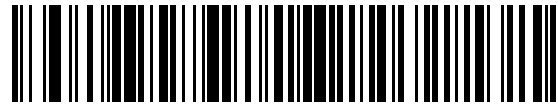

**MSI - Two Discrete Lengths**

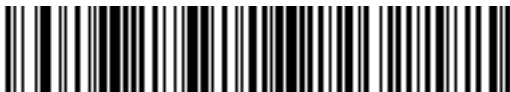

**\*MSI - Length Within Range  
(Default: 4 - 55)**



**MSI - Any Length**

## MSI Check Digits

### Parameter # 50

#### SSI # 32h

With MSI symbols, one check digit is mandatory and always verified by the reader. The second check digit is optional. If the MSI codes include two check digits, scan the **Two MSI Check Digits** bar code to enable verification of the second check digit.

See [MSI Check Digit Algorithm on page 13-65](#) to select second digit algorithms.

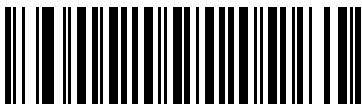

**\*One MSI Check Digit  
(0)**

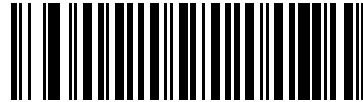

**Two MSI Check Digits  
(1)**

## Transmit MSI Check Digit(s)

### Parameter # 46

#### SSI # 2Eh

Scan one of the following bar codes to transmit MSI data with or without the check digit.

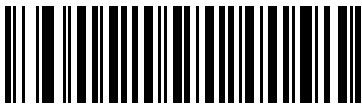

**Transmit MSI Check Digit(s) (Enable)  
(1)**



**\*Do Not Transmit MSI Check Digit(s) (Disable)  
(0)**

## MSI Check Digit Algorithm

Parameter # 51

SSI # 33h

Two algorithms are available for verifying the second MSI check digit. Scan one of the following bar codes to select the algorithm used to encode the check digit.

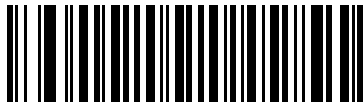

MOD 11/MOD 10  
(0)



\*MOD 10/MOD 10  
(1)

## MSI Reduced Quiet Zone

Parameter # 1392

SSI # F8h 05h 70h

Scan one of the following bar codes to enable or disable decoding MSI bar codes with reduced quiet zones. If you select **Enable MSI Reduced Quiet Zone**, select a [1D Quiet Zone Level on page 13-78](#).

✓ **NOTE** MSI does not support 1D Quiet Zone Level 3.



\*Disable MSI Reduced Quiet Zone  
(0)



Enable MSI Reduced Quiet Zone  
(1)

---

## Chinese 2 of 5

**Parameter # 408**

**SSI # F0h 98h**

Scan one of the following bar codes to enable or disable Chinese 2 of 5.



**Enable Chinese 2 of 5  
(1)**

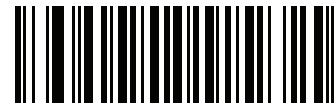

**\*Disable Chinese 2 of 5  
(0)**

---

## Matrix 2 of 5

**Parameter # 618**

**SSI # F1h 6Ah**

Scan one of the following bar codes to enable or disable Matrix 2 of 5.



**Enable Matrix 2 of 5  
(1)**



**\*Disable Matrix 2 of 5  
(0)**

## Set Lengths for Matrix 2 of 5

**L1 = Parameter # 619**

**SSI # F1h 6Bh**

**L2 = Parameter # 620**

**SSI # F1h 6Ch**

- ✓ **NOTE** The maximum number of 1D bar code characters readable with scanner depends on the type of symbology, type of characters (i.e., digits or letters), printing density, and quality. For reference, the DS2278 reads 3.1 in wide, 10mil 1D bar codes printed with 1200dpi resolution and 80% contrast.

The length of a code refers to the number of characters (i.e., human readable characters), including check digit(s) the code contains. Set lengths for Matrix 2 of 5 to any length, one or two discrete lengths, or lengths within a specific range. Minimum and maximum length range is from 0 - 55. The default minimum and maximum length range is from 4 - 55.

- ✓ **NOTE** When setting lengths, enter a leading zero for single digit numbers.

Scan one of the following bar codes to select a length option:

- **One Discrete Length** - Decode only Matrix 2 of 5 symbols containing a selected length. Select the length using the bar codes in [Appendix G, Numeric Bar Codes](#). For example, to decode only Matrix 2 of 5 symbols with 14 characters, scan **Matrix 2 of 5 - One Discrete Length**, and then scan **1, 4**. To correct an error or change the selection, scan *Cancel on page G-3*.
- **Two Discrete Lengths** - Decode only Matrix 2 of 5 symbols containing either of two lengths. Select lengths using the bar codes in [Appendix G, Numeric Bar Codes](#). For example, to decode only Matrix 2 of 5 symbols containing either 2 or 14 characters, scan **Matrix 2 of 5 - Two Discrete Lengths**, and then scan **0, 2, 1, 4**. To correct an error or change the selection, scan *Cancel on page G-3*.
- **Length Within Range** - Decode Matrix 2 of 5 symbols with a specific length range. Select lengths using the bar codes in [Appendix G, Numeric Bar Codes](#). For example, to decode Matrix 2 of 5 symbols containing between 4 and 12 characters, scan **Matrix 2 of 5 - Length Within Range**, and then scan **0, 4, 1, 2**. To correct an error or change the selection, scan *Cancel on page G-3*.
- **Any Length** - Decode Matrix 2 of 5 symbols containing any number of characters within the scanner's capability.



## Set Lengths for Matrix 2 of 5 (continued)

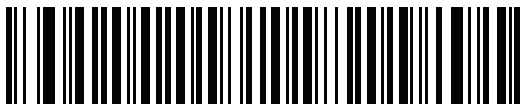

Matrix 2 of 5 - One Discrete Length



Matrix 2 of 5 - Two Discrete Lengths



\*Matrix 2 of 5 - Length Within Range  
(Default 4 - 55)



Matrix 2 of 5 - Any Length

## Matrix 2 of 5 Check Digit

Parameter # 622

SSI # F1h 6Eh

The check digit is the last character of the symbol used to verify the integrity of the data. Scan one of the following bar codes to determine whether to include the Matrix 2 of 5 check digit with the bar code data.



Enable Matrix 2 of 5 Check Digit  
(1)



\*Disable Matrix 2 of 5 Check Digit  
(0)

## Transmit Matrix 2 of 5 Check Digit

Parameter # 623

SSI # F1h 6Fh

Scan one of the following bar codes to transmit Matrix 2 of 5 data with or without the check digit.



Transmit Matrix 2 of 5 Check Digit  
(1)



\*Do Not Transmit Matrix 2 of 5 Check Digit  
(0)

---

## Korean 3 of 5

Parameter # 581

SSI # F1h 45h

Scan one of the following bar codes to enable or disable Korean 3 of 5.

✓ **NOTE** The length for Korean 3 of 5 is fixed at 6.



Enable Korean 3 of 5  
(1)



\*Disable Korean 3 of 5  
(0)

---

## Inverse 1D

### Parameter # 586

### SSI # F1h 4Ah

Scan one of the following bar codes to set the 1D inverse decoder setting:

- **Regular Only** - The scanner decodes regular 1D bar codes only.
- **Inverse Only** - The scanner decodes inverse 1D bar codes only.
- **Inverse Autodetect** - The scanner decodes both regular and inverse 1D bar codes.

✓ **NOTE** This parameter does not apply to GS1 DataBar code types.

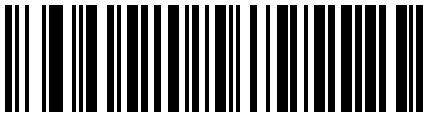

\*Regular  
(0)

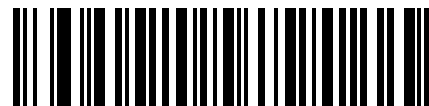

Inverse Only  
(1)



Inverse Autodetect  
(2)

---

## GS1 DataBar

The variants of GS1 DataBar are DataBar-14, DataBar Expanded, and DataBar Limited. The limited and expanded versions have stacked variants. Scan the appropriate bar codes to enable or disable each variant of GS1 DataBar.

### GS1 DataBar Omnidirectional (formerly GS1 DataBar-14), GS1 DataBar Truncated, GS1 DataBar Stacked, GS1 DataBar Stacked Omnidirectional

Parameter # 338

SSI # F0h 52h

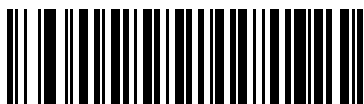

\*Enable GS1 DataBar Omnidirectional  
(1)

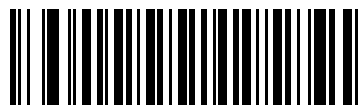

Disable GS1 DataBar Omnidirectional  
(0)

### GS1 DataBar Limited

Parameter # 339

SSI # F0h 53h

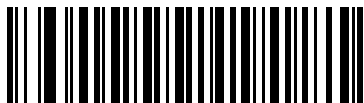

\*Enable GS1 DataBar Limited  
(1)

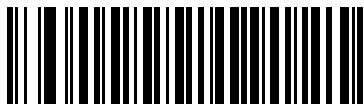

Disable GS1 DataBar Limited  
(0)

**GS1 DataBar Expanded, GS1 DataBar Expanded Stacked****Parameter # 340****SSI # F0h 54h**

**\*Enable GS1 DataBar Expanded  
(1)**



**Disable GS1 DataBar Expanded  
(0)**

**Convert GS1 DataBar to UPC/EAN/JAN****Parameter # 397****SSI # F0h, 8Dh**

This parameter only applies to GS1 DataBar Omnidirectional and GS1 DataBar Limited symbols not decoded as part of a Composite symbol. Scan **Enable Convert GS1 DataBar to UPC/EAN/JAN** to strip the leading '010' from DataBar-14 and DataBar Limited symbols encoding a single zero as the first digit, and report the bar code as EAN-13.

For bar codes beginning with between two and five zeros, this strips the leading '0100' and reports the bar code as UPC-A. The *UPC-A Preamble* option that transmits the system character and country code applies to converted bar codes. Note that neither the system character nor the check digit can be stripped.

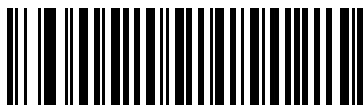

**Enable Convert GS1 DataBar to UPC/EAN/JAN  
(1)**

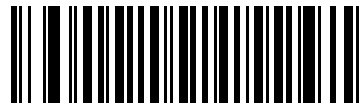

**\*Disable Convert GS1 DataBar to UPC/EAN/JAN  
(0)**

## GS1 DataBar Limited Margin Check

### Parameter # 728

### SSI # F1h D8h

The decoder offers four levels of margin check for GS1 DataBar Limited bar codes. There is an inverse relationship between level of margin check and decoder aggressiveness. Increasing the level of margin check may result in reduced aggressiveness in scanning, so only choose the level of margin check necessary.

- Level 1: No clear margin required. This complies with the original GS1 standard, yet might result in erroneous decoding of the DataBar Limited bar code when scanning some UPC symbols that start with the digits 9 and 7.
- Level 2: Automatic risk detection. This level of security may result in erroneous decoding of DataBar Limited bar codes when scanning some UPC symbols. If a misdecode is detected, the decoder operates in Level 3 or Level 1.
- Level 3: Margin check level reflects newly proposed GS1 standard that requires a 5x trailing clear margin.
- Level 4: Margin check level extends beyond the standard required by GS1. This level of security requires a 5x leading and trailing clear margin.



**GS1 DataBar Limited Margin Check Level 1**  
(1)



**GS1 DataBar Limited Margin Check Level 2**  
(2)



**\*GS1 DataBar Limited Margin Check Level 3**  
(3)



**GS1 DataBar Limited Margin Check Level 4**  
(4)

## GS1 DataBar Security Level

### Parameter # 1706

### SSI # F8h 06h AAh

The decoder offers four levels of decode security for GS1 DataBar (GS1 DataBar Omnidirectional, GS1 DataBar Limited, GS1 DataBar Expanded) bar codes.

- Security Level 0: This setting allows the digital scanner to operate in its most aggressive state, while providing sufficient security in decoding most in-spec bar codes.
- Security Level 1: This setting eliminates most misdecodes while maintaining reasonable aggressiveness (default).
- Security Level 2: This setting allows greater bar code security requirements if Security Level 1 fails to eliminate misdecodes.
- Security Level 3: This setting applies the highest safety requirements. Select if Security Level 2 was applied and misdecodes still occur.



**Security Level 0**  
(0)



**\* Security Level 1**  
(1)



**Security Level 2**  
(2)



**Security Level 3**  
(3)

---

## Symbology-Specific Security Features

### Redundancy Level

#### Parameter # 78

#### SSI # 4Eh

The scanner offers four levels of decode redundancy. Select higher redundancy levels for decreasing levels of bar code quality. As redundancy levels increase, the scanner's aggressiveness decreases.

Scan one of the following bar codes to select the redundancy level appropriate for the bar code quality:

- **Redundancy Level 1** - The scanner must read the following code types twice before decoding:
  - Codabar (8 characters or less)
  - MSI (4 characters or less)
  - D 2 of 5 (8 characters or less)
  - I 2 of 5 (8 characters or less)
- **Redundancy Level 2** - The scanner must read all code types twice before decoding.
- **Redundancy Level 3** - The scanner must read code types other than the following twice before decoding, but must read the following codes three times:
  - Codabar (8 characters or less)
  - MSI (4 characters or less)
  - D 2 of 5 (8 characters or less)
  - I 2 of 5 (8 characters or less)
- **Redundancy Level 4** - The scanner must read all code types three times before decoding.



## Redundancy Level (continued)



**\*Redundancy Level 1  
(1)**

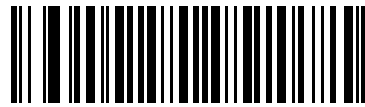

**Redundancy Level 2  
(2)**

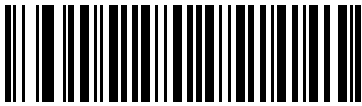

**Redundancy Level 3  
(3)**

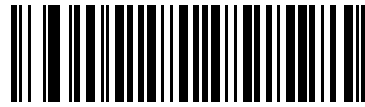

**Redundancy Level 4  
(4)**

## Security Level

### Parameter # 77

#### SSI # 4Dh

The scanner offers four levels of decode security for delta bar codes, which include the Code 128 family, UPC/EAN/JAN, and Code 93. Select increasing levels of security for decreasing levels of bar code quality. There is an inverse relationship between security and scanner aggressiveness, so choose only that level of security necessary for the application.

- **Security Level 0** - The scanner operates in its most aggressive state, while providing sufficient security decoding most “in-spec” bar codes.
- **Security Level 1** - This default setting eliminates most misdecodes.
- **Security Level 2** - Select this option if Security Level 1 fails to eliminate misdecodes.
- **Security Level 3** - If you selected Security Level 2 and misdecodes still occur, select this security level.

✓ **NOTE** Selecting this option is an extreme measure against mis-decoding severely out-of-spec bar codes, and significantly impairs the decoding ability of the scanner. If this level of security is required, try to improve the quality of the bar codes.



**Security Level 0**  
(0)



**\*Security Level 1**  
(1)

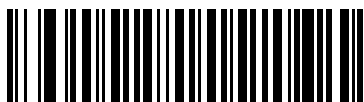

**Security Level 2**  
(2)



**Security Level 3**  
(3)

## 1D Quiet Zone Level

### Parameter # 1288

### SSI # F8h 05h 08h

This feature sets the level of aggressiveness when decoding bar codes with a reduced quiet zone (the margin on either side of a bar code), and applies to symbologies enabled by a Reduced Quiet Zone parameter. Because higher levels increase the decoding time and risk of misdecodes, Zebra strongly recommends enabling only the symbologies which require higher quiet zone levels, and leaving Reduced Quiet Zone disabled for all other symbologies. Options are:

- **1D Quiet Zone Level 0** - The scanner performs normally in terms of quiet zone.
- **1D Quiet Zone Level 1** - The scanner performs more aggressively in terms of quiet zone.
- **1D Quiet Zone Level 2** - The scanner only requires a quiet zone at the end of bar code for decoding.
- **1D Quiet Zone Level 3** - The scanner decodes anything in terms of quiet zone or end of bar code.

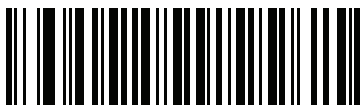

1D Quiet Zone Level 0  
(0)



\*1D Quiet Zone Level 1  
(1)



1D Quiet Zone Level 2  
(2)



1D Quiet Zone Level 3  
(3)

## Intercharacter Gap Size

### Parameter # 381

#### SSI # F0h, 7Dh

The Code 39 and Codabar symbologies have an intercharacter gap that is typically quite small. Due to various bar code printing technologies, this gap can grow larger than the maximum size allowed, preventing the scanner from decoding the symbol. If this problem occurs, scan the **Large Intercharacter Gaps** parameter to tolerate these out-of-specification bar codes.

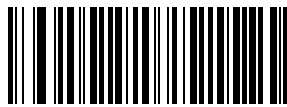

**\*Normal Intercharacter Gaps**  
(6)



**Large Intercharacter Gaps**  
(10)

---

## Composite

### Composite CC-C

#### Parameter # 341

#### SSI # F0h 55h

Scan one of the following bar codes to enable or disable Composite bar codes of type CC-C.



**Enable CC-C**  
(1)



**\*Disable CC-C**  
(0)

## Composite CC-A/B

Parameter # 342

SSI # F0h 56h

Scan one of the following bar codes to enable or disable Composite bar codes of type CC-A/B.

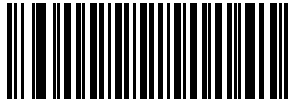

Enable CC-A/B  
(1)

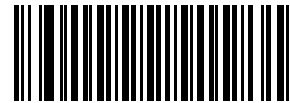

\*Disable CC-A/B  
(0)

## Composite TLC-39

Parameter # 371

SSI # F0h 73h

Scan one of the following bar codes to enable or disable Composite bar codes of type TLC-39.

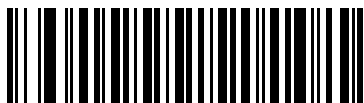

Enable TLC39  
(1)



\*Disable TLC39  
(0)

## Composite Inverse

### Parameter # 1113

### SSI # F8h 04h 59h

This parameter sets Composite for either regular decode or inverse decode. This mode only supports Inverse Composite that has DataBar combined with CCAB. No other 1D/2D combinations.

- **Regular Only:** The digital scanner decodes regular Composite bar codes only. (default).
- **Inverse Only:** The digital scanner decodes inverse Composite bar codes only. For this parameter to work as expected, [Composite CC-A/B on page 13-80](#) and corresponding 1D Inverse or 1D Inverse Autodetect ([page 13-70](#)) must be enabled.



**NOTE** To decode regular Composite, Composite Inverse must be set to **Regular Only** and Inverse 1D must be set to **Regular Only** or **Autodetect**.

To decode inverse Composite, Composite Inverse must be set to **Inverse Only** and Inverse 1D must be set to **Inverse Only** or **Autodetect**.



\* Regular Only  
(0)



Inverse Only  
(1)

## UPC Composite Mode

### Parameter # 344

### SSI # F0h 58h

Select an option for linking UPC symbols with a 2D symbol during transmission as if they were one symbol:

- **UPC Never Linked** - Transmit UPC bar codes regardless of whether a 2D symbol is detected.
- **UPC Always Linked** - Transmit UPC bar codes and the 2D portion. If 2D is not present, do not transmit the bar code.
- **Autodiscriminate UPC Composites** - The scanner determines if there is a 2D portion, then transmits the UPC, as well as the 2D portion if present.

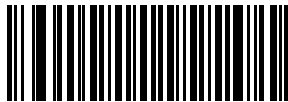

**\*UPC Never Linked**  
(0)



**UPC Always Linked**  
(1)



**Autodiscriminate UPC Composites**  
(2)

## Composite Beep Mode

### Parameter # 398

#### SSI # F0h, 8Eh

Scan one of the following bar codes to select the number of decode beeps that sound upon decoding a Composite bar code.

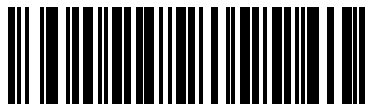

Single Beep After Both are Decoded  
(0)



\*Beep as Each Code Type is Decoded  
(1)

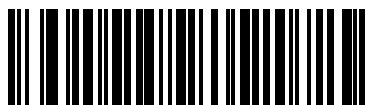

Double Beep After Both are Decoded  
(2)

## GS1-128 Emulation Mode for UCC/EAN Composite Codes

### Parameter # 427

#### SSI # F0h, ABh

Scan one of the following bar codes to enable or disable this mode.



Enable GS1-128 Emulation Mode for  
UCC/EAN Composite Codes  
(1)



\*Disable GS1-128 Emulation Mode for  
UCC/EAN Composite Codes  
(0)



---

## 2D Symbologies

### PDF417

Parameter # 15

SSI # 0Fh

Scan one of the following bar codes to enable or disable PDF417.



**\*Enable PDF417  
(1)**



**Disable PDF417  
(0)**

### MicroPDF417

Parameter # 227

SSI # E3h

Scan one of the following bar codes to enable or disable MicroPDF417.



**Enable MicroPDF417  
(1)**

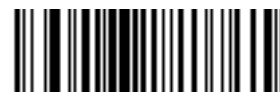

**\*Disable MicroPDF417  
(0)**

## Code 128 Emulation

### Parameter # 123

#### SSI # 7Bh

Enable this parameter to transmit data from certain MicroPDF417 symbols as Code 128. You must enable *AIM Code Identifiers* on page E-3 for this parameter to work.

Enable Code 128 Emulation to transmit these MicroPDF417 symbols with one of the following prefixes:

- ]C1 if the first codeword is 903-905
- ]C2 if the first codeword is 908 or 909
- ]C0 if the first codeword is 910 or 911

Disable Code 128 Emulation to transmit these MicroPDF417 symbols with one of the following prefixes:

- ]L3 if the first codeword is 903-905
- ]L4 if the first codeword is 908 or 909
- ]L5 if the first codeword is 910 or 911

Scan one of the following bar codes to enable or disable Code 128 Emulation.



**NOTE** Linked MicroPDF codewords 906, 907, 912, 914, and 915 are not supported. Use GS1 Composites instead.



**Enable Code 128 Emulation**  
(1)



**\*Disable Code 128 Emulation**  
(0)

## Data Matrix

Parameter # 292

SSI # F0h, 24h

Scan one of the following bar codes to enable or disable Data Matrix.



**\*Enable Data Matrix  
(1)**

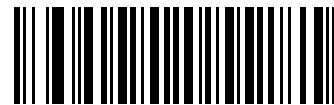

**Disable Data Matrix  
(0)**

## GS1 Data Matrix

Parameter # 1336

SSI # F8h 05h 38h

Scan one of the following bar codes to enable or disable GS1 Data Matrix.



**Enable GS1 Data Matrix  
(1)**



**\*Disable GS1 Data Matrix  
(0)**

## Data Matrix Inverse

### Parameter # 588

### SSI # F1h 4Ch

Scan one of the following bar codes to select the Data Matrix inverse decoder setting:

- **Regular Only** - The scanner decodes regular Data Matrix bar codes only.
- **Inverse Only** - The scanner decodes inverse Data Matrix bar codes only.
- **Inverse Autodetect** - The scanner decodes both regular and inverse Data Matrix bar codes.

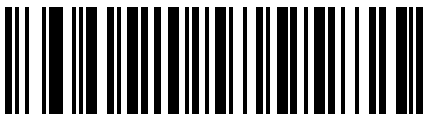

**Regular Only**  
(0)

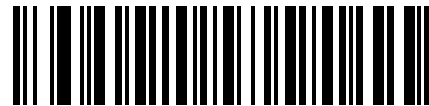

**Inverse Only**  
(1)



**\*Inverse Autodetect**  
(2)

## Decode Data Matrix Mirror Images

### Parameter # 537

#### SSI # F1h 19h

Scan one of the following bar codes to select an option for decoding mirror image Data Matrix bar codes:

- **Never** - Do not decode Data Matrix bar codes that are mirror images.
- **Always** - Decode only Data Matrix bar codes that are mirror images.
- **Auto** - Decode both mirrored and unmirrored Data Matrix bar codes.

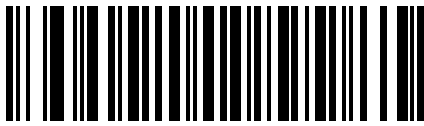

**Never**  
(0)

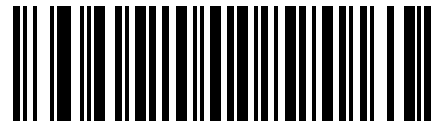

**Always**  
(1)

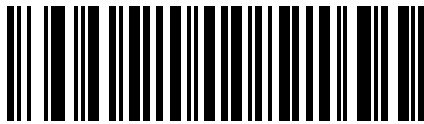

**\*Auto**  
(2)

## Maxicode

Parameter # 294

SSI # F0h, 26h

Scan one of the following bar codes to enable or disable Maxicode.



Enable Maxicode  
(1)

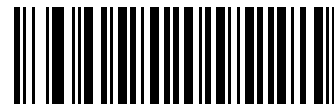

\*Disable Maxicode  
(0)

## QR Code

Parameter # 293

SSI # F0h, 25h

Scan one of the following bar codes to enable or disable QR Code.

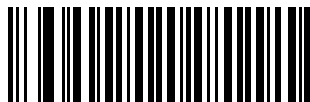

\*Enable QR Code  
(1)



Disable QR Code  
(0)

## GS1 QR

Parameter # 1343

SSI # F8h 05h 3Fh

Scan one of the following bar codes to enable or disable GS1 QR.

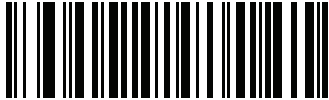

Enable GS1 QR  
(1)

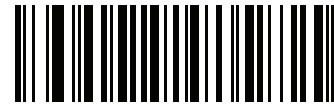

\*Disable GS1 QR  
(0)

## MicroQR

Parameter # 573

SSI # F1h 3Dh

Scan one of the following bar codes to enable or disable MicroQR.

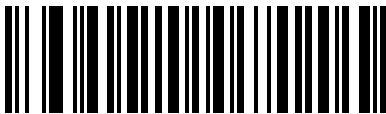

\*Enable MicroQR  
(1)

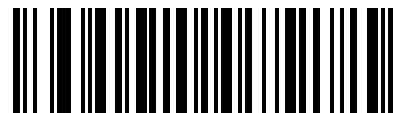

Disable MicroQR  
(0)

## **Weblink QR**

**Parameter #1947**

**SSI # F8 07 9Bh**

Scan **Decode Weblink QR Codes** to decode Weblink QR bar codes.

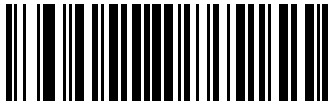

**Do Not Decode Weblink QR Codes  
(0)**

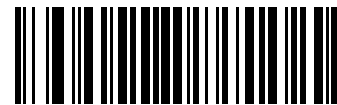

**\*Decode Weblink QR Codes  
(1)**



## Linked QR

### Parameter # 1847

### SSI # 737h

Scan one of the following barcodes to select a linked QR mode:

- **Linked QR Only** - The scanner does not decode individual QR symbols from a set of Linked QR codes.
- **Individual QR With Headers** - The scanner decodes individual QR symbols from a set of Linked QR codes and retains the header information and data.
- **Individual QR No Headers** - The scanner decodes individual QR symbols from a set of Linked QR codes and transmits the data without header information.



\*Linked QR Only  
(0)



Individual QR With Headers  
(1)

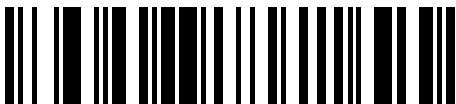

Individual QR No Headers  
(2)

## Aztec

### Parameter # 574

### SSI # F1h 3Eh

Scan one of the following bar codes to enable or disable Aztec.

✓ **NOTE** Enabling this also enables Linked Aztec.

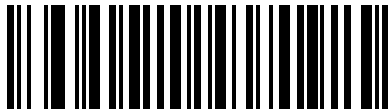

**\*Enable Aztec**  
(1)

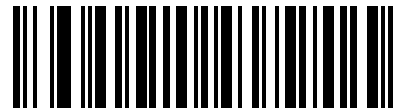

**Disable Aztec**  
(0)

## Aztec Inverse

### Parameter # 589

### SSI # F1h 4Dh

Scan one of the following bar codes to select the Aztec inverse decoder setting:

- **Regular Only** - The scanner decodes regular Aztec bar codes only.
- **Inverse Only** - The scanner decodes inverse Aztec bar codes only.
- **Inverse Autodetect** - The scanner decodes both regular and inverse Aztec bar codes.



**Regular Only**  
(0)



**Inverse Only**  
(1)



**\*Inverse Autodetect**  
(2)

## Han Xin

**Parameter # 1167**

**SSI # F8h 04h 8Fh**

Scan one of the following bar codes to enable or disable Han Xin.



**Enable Han Xin  
(1)**



**\*Disable Han Xin  
(0)**

## Han Xin Inverse

**Parameter # 1168**

**SSI # F8h 04h 90h**

Scan one of the following bar codes to select a Han Xin inverse decoder setting:

- **Regular Only** - The scanner decodes Han Xin bar codes with normal reflectance only.
- **Inverse Only** - The scanner decodes Han Xin bar codes with inverse reflectance only.
- **Inverse Autodetect** - The scanner decodes both regular and inverse Han Xin bar codes.

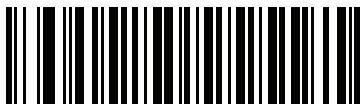

**\*Regular Only  
(0)**

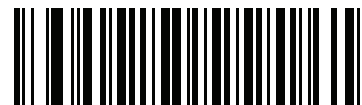

**Inverse Only  
(1)**



**Inverse Autodetect  
(2)**

## Grid Matrix

**Parameter # 1718**

**SSI # F8h 06h B6h**

Scan one of the following bar codes to enable or disable Grid Matrix.

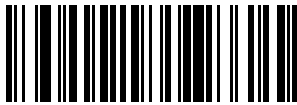

**Enable**  
(1)



**\*Disable**  
(0)

## Grid Matrix Inverse

**Parameter # 1719**

**SSI # F8h 06h B7h**

Scan one of the following bar codes to select a Grid Matrix inverse decoder setting:

- **Regular Only** - The scanner decodes regular Grid Matrix bar codes only.
- **Inverse Only** - The scanner decodes inverse Grid Matrix bar codes only.
- **Autodiscriminate** - The scanner decodes both regular and inverse Grid Matrix bar codes.

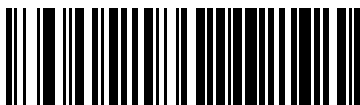

**\*Regular Only**  
(0)

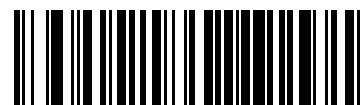

**Inverse Only**  
(1)

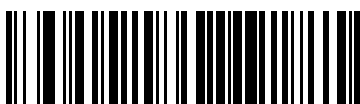

**Autodiscriminate**  
(2)

## Grid Matrix Mirror

Parameter # 1736

SSI # F8h 06h C8h

Scan one of the following bar codes to select a Grid Matrix mirror decoder setting:

- **Regular Only** - The scanner decodes regular Grid Matrix bar codes only.
- **Mirrored Only** - The scanner decodes mirrored Grid Matrix bar codes only.
- **Auto-discriminate** - The scanner decodes both regular and mirrored Grid Matrix bar codes.

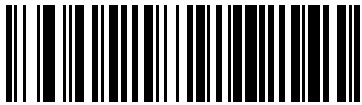

**\*Regular Only**  
(0)

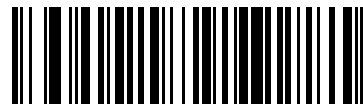

**Mirrored Only**  
(1)



**Autodiscriminate**  
(2)

**DotCode****Parameter # 1906****SSI # F8 07 72h**

Scan one of the following barcodes to enable or disable DotCode.



**\*Disable DotCode  
(0)**

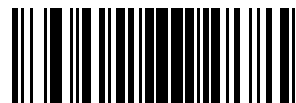

**Enable DotCode  
(1)**

## DotCode Inverse

Parameter # 1907

SSI # F8 07 73h

Scan one of the following barcodes to select a DotCode Inverse decoder setting. Setting options are:

- **Regular Only** - Decoder decodes DotCode barcodes with normal reflectance only.
- **Inverse Only** - Decoder decodes DotCode barcodes with inverse reflectance only.
- **Inverse Autodetect** - Decoder decodes both regular and inverse DotCode barcodes.

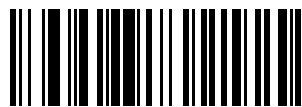

**Regular**  
**(0)**



**Inverse Only**  
**(1)**

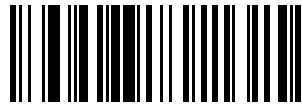

**\*Autodetect**  
**(2)**

## DotCode Mirrored

### Parameter # 1908

### SSI # F8 07 74h

Scan one of the following barcodes to select a DotCode Mirror decoder setting:

- **Non-Mirrored Only** - Digital scanner decodes non-mirrored DotCode barcodes only.
- **Mirrored Only** - Digital scanner decodes mirrored DotCode barcodes only.
- **Autodetect** - Digital scanner decodes both mirrored and non-mirrored DotCode barcodes.

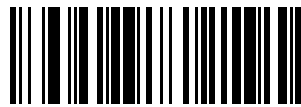

**Never**  
**(0)**

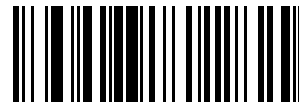

**Always**  
**(1)**



**\*Autodetect**  
**(2)**



## DotCode Prioritize

Parameter # 1937

SSI # F8 07 91h

Enable DotCode Prioritize to give priority to DotCode decoding as compared to other symbologies.

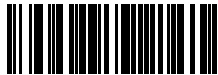

Disable  
(0)



\*Enable  
(1)

## DotCode Erasure Limit

Parameter # 2063

SSI # F8 08 0F

This parameter sets the maximum number of erasures in DotCode codewords before passing the codewords for error correction. The value range is from 4 to 20. The default value is 10.

A bigger value means that DotCode barcodes are easier to decode, but the chance of getting a misdecode is higher.

To set a DotCode Erasure Limit value, scan the following barcode, and then scan two barcodes from *Numeric Bar Codes on page G-1* that correspond to the desired value. Enter a leading zero for single digit numbers. For example, to set an erasure value of 4, scan this barcode, and then scan the **0** and **4** barcodes. To correct an error or change the selection, scan [Cancel on page G-3](#).



DotCode Erasure Limit

## Escape Characters

### Parameter # 233

#### SSI # E9h

This enables the backslash (\) character as an Escape character for systems that can process transmissions containing special data sequences. Scan one of the following bar codes to either format special data according to the GLI (Global Label Identifier) protocol, or to disable this parameter. This parameter only affects the data portion of a Macro PDF symbol transmission; the Macro PDF Control Header (if enabled) is always sent with GLI formatting.



**GLI Protocol  
(2)**



**\*None  
(0)**

### Flush Macro PDF Buffer

Scan the following bar code to flush the buffer of all decoded Macro PDF data stored to that point, transmit it to the host device, and abort from Macro PDF mode.

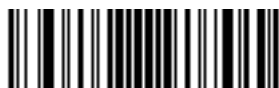

**Flush Macro PDF Buffer**

### Abort Macro PDF Entry

Scan the following bar code to clear all currently-stored Macro PDF data in the buffer without transmission and abort from Macro PDF mode.



**Abort Macro PDF Entry**

---

## Postal Codes

### US Postnet

Parameter # 89

SSI # 59h

Scan one of the following bar codes to enable or disable US Postnet.



**Enable US Postnet  
(1)**

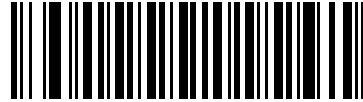

**\*Disable US Postnet  
(0)**

### US Planet

Parameter # 90

SSI # 5Ah

Scan one of the following bar codes to enable or disable US Planet.



**Enable US Planet  
(1)**



**\*Disable US Planet  
(0)**

## Transmit US Postal Check Digit

Parameter # 95

SSI # 5Fh

Scan one of the following bar codes to select whether to transmit US Postal data, which includes both US Postnet and US Planet, with or without the check digit.

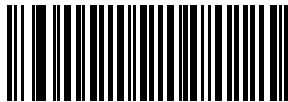

**\*Transmit US Postal Check Digit  
(1)**

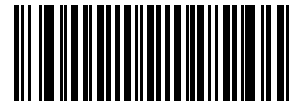

**Do Not Transmit US Postal Check Digit  
(0)**

## UK Postal

Parameter # 91

SSI # 5Bh

Scan one of the following bar codes to enable or disable UK Postal.



**Enable UK Postal  
(1)**

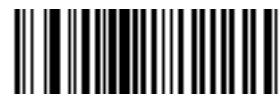

**\*Disable UK Postal  
(0)**

## Transmit UK Postal Check Digit

Parameter # 96

SSI # 60h

Scan one of the following bar codes to select whether to transmit UK Postal data with or without the check digit.

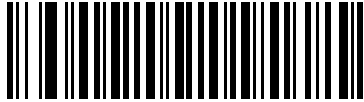

**\*Transmit UK Postal  
Check Digit  
(1)**

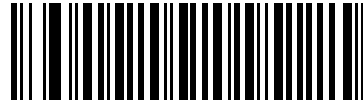

**Do Not Transmit UK Postal Check Digit  
(0)**

## Japan Postal

Parameter # 290

SSI # F0h, 22h

Scan one of the following bar codes to enable or disable Japan Postal.



**Enable Japan Postal  
(1)**

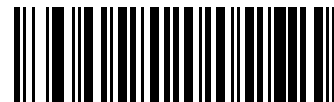

**\*Disable Japan Postal  
(0)**

## Australia Post

Parameter # 291

SSI # F0h, 23h

Scan one of the following bar codes to enable or disable Australia Post.



**Enable Australia Post  
(1)**



**\*Disable Australia Post  
(0)**

## Australia Post Format

### Parameter # 718

### SSI # F1h, CEh

Scan one of the following bar codes to select a format for Australia Post:

- **Autodiscriminate** (or Smart mode) - Decode the Customer Information Field using the N and C Encoding Tables.
- ✓ **NOTE** This option increases the risk of misdecodes because the encoded data format does not specify the Encoding Table used for encoding.
- **Raw Format** - Output raw bar patterns as a series of numbers 0 through 3.
- **Alphanumeric Encoding** - Decode the Customer Information Field using the C Encoding Table.
- **Numeric Encoding** - Decode the Customer Information Field using the N Encoding Table.

For more information on Australia Post Encoding Tables, refer to the *Australia Post Customer Barcoding Technical Specifications* available at [www.auspost.com.au](http://www.auspost.com.au).



\*Autodiscriminate  
(0)



Raw Format  
(1)



Alphanumeric Encoding  
(2)



Numeric Encoding  
(3)

**Netherlands KIX Code****Parameter # 326****SSI # F0h, 46h**

Scan one of the following bar codes to enable or disable Netherlands KIX Code.

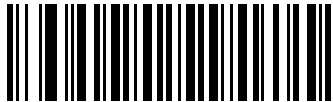

**Enable Netherlands KIX Code**  
(1)

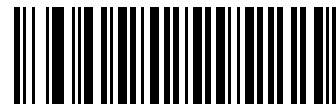

**\*Disable Netherlands KIX Code**  
(0)

**USPS 4CB/One Code/Intelligent Mail****Parameter # 592****SSI # F1h 50h**

Scan one of the following bar codes to enable or disable USPS 4CB/One Code/Intelligent Mail.



**Enable USPS 4CB/One Code/Intelligent Mail**  
(1)



**\*Disable USPS 4CB/One Code/Intelligent Mail**  
(0)



## UPU FICS Postal

Parameter # 611

SSI # F1h 63h

Scan one of the following bar codes to enable or disable UPU FICS Postal.



Enable UPU FICS Postal  
(1)



\*Disable UPU FICS Postal  
(0)

## Mailmark

Parameter # 1337

SSI # F8h 05h 39h

Scan one of the following bar codes to enable or disable Mailmark.

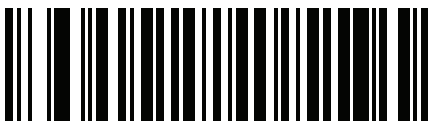

\*Disable Mailmark  
(0)

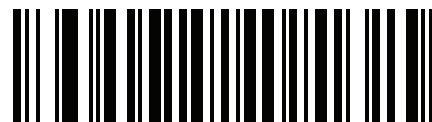

Enable Mailmark  
(1)

# CHAPTER 14 DATA FORMATTING: ADF

---

## Introduction

This chapter briefly describes the Zebra features available for customizing scanner operation.

---

## Advanced Data Formatting (ADF)

Advanced Data Formatting (ADF) is a means of customizing data from before transmission to the host device. Use ADF to edit scan data to suit your host's requirements. With ADF you scan one barcode per trigger pull. ADF is programmed using 123Scan.

To watch a video on Creating an Advanced Data Formatting (ADF) Rule using 123Scan, go to:  
<http://www.zebra.com/ScannerHowToVideos>

For additional information, refer to the *Advanced Data Formatting Programmer Guide*.



# APPENDIX A STANDARD DEFAULT PARAMETERS

**Table A-1** *Parameter Defaults*

Parameter	Parameter Number	SSI Number	Default	Page Number
HID Device Conversion	N/A	N/A	Scanner as CDC Device	<a href="#">1-6</a>
Shutting Off the Digital Scanner Battery	N/A	N/A	N/A	<a href="#">1-7</a>
Report Software Version Bar Code	N/A	N/A	N/A	<a href="#">4-7</a>
<b>User Preferences</b>				
Set Default Parameter	N/A	N/A	N/A	<a href="#">5-5</a>
Parameter Bar Code Scanning	236	ECh	Enable	<a href="#">5-6</a>
Beep After Good Decode	56	38h	Enable	<a href="#">5-6</a>
Beeper Volume	140	8Ch	High	<a href="#">5-7</a>
Beeper Tone	145	91h	Medium	<a href="#">5-8</a>
Beeper Duration	628	F1h 74h	Medium	<a href="#">5-9</a>
Suppress Power Up Beeps	721	F1h D1h	Do Not Suppress	<a href="#">5-9</a>
LED on Good Decode	744	F1h E8h	Enable	<a href="#">5-10</a>
Direct Decode Indicator	859	F2h 5Bh	Disable	<a href="#">5-10</a>
Low Power Mode	128	80h	Enable	<a href="#">5-11</a>
Time Delay to Low Power Mode	146	92h	100 msec	<a href="#">5-12</a>
Timeout to Low Power Mode from Auto Aim	729	F1h D9h	15 sec	<a href="#">5-14</a>
Battery Preservation Mode	1765	F8h 06h E5h	Enable	<a href="#">5-15</a>

**Table A-1** *Parameter Defaults (Continued)*

Parameter	Parameter Number	SSI Number	Default	Page Number
Trigger Mode (or Hand-Held Trigger Mode)	138	8Ah	Standard (Level)	<a href="#">5-16</a>
Hands-Free Mode	630	F1h 76h	Enable	<a href="#">5-17</a>
Hand-Held Decode Aiming Pattern	306	F0h 32h	Enable	<a href="#">5-18</a>
Hands-Free (Presentation) Decode Aiming Pattern	590	F1h 4Eh	Enable Hands-Free (Presentation) Decode Aiming Pattern on PDF	<a href="#">5-19</a>
Picklist Mode	402	F0h 92h	Disable Picklist Mode Always	<a href="#">5-20</a>
Continuous Bar Code Read	649	F1h 89h	Disable	<a href="#">5-21</a>
Unique Bar Code Reporting	723	F1h D3h	Enable	<a href="#">5-21</a>
Decode Session Timeout	136	88h	9.9 Seconds	<a href="#">5-22</a>
Hands-Free Decode Session Timeout	400	F0 90	15	<a href="#">5-22</a>
Timeout Between Decodes, Same Symbol	137	89h	0.5 Seconds	<a href="#">5-23</a>
Timeout Between Decodes, Different Symbols	144	90h	0.1 Seconds	<a href="#">5-23</a>
Decode Mirror Images (Data Matrix Only)	537	F1h 19h	Auto	<a href="#">5-24</a>
Mobile Phone/Display Mode	N/A	N/A	N/A	<a href="#">5-24</a>
PDF Prioritization	719	F1h CFh	Disable	<a href="#">5-25</a>
PDF Prioritization Timeout	720	F1h D0h	200 ms	<a href="#">5-25</a>
Decoding Illumination	298	F0h 2Ah	Enable	<a href="#">5-26</a>
Illumination Brightness	669	F1h 9Dh	High	<a href="#">5-26</a>
Low Light Scene Detection	810	F2h 2Ah	Dim Illumination Low Light Assist Scene Detection	<a href="#">5-27</a>
Motion Tolerance (Hand-Held Trigger Mode Only)	858	F2h 5Ah	Less	<a href="#">5-28</a>
Product ID (PID) Type	1281	F8h 05h 01h	Host Type Unique	<a href="#">5-29</a>
Product ID (PID) Value	1725	F8h 06h BDh	0	<a href="#">5-29</a>
ECLevel	1710	F8h 06h AEh	0	<a href="#">5-30</a>

**Table A-1** *Parameter Defaults (Continued)*

Parameter	Parameter Number	SSI Number	Default	Page Number
<b>Miscellaneous Options</b>				
Enter Key	N/A	N/A	N/A	<a href="#">5-31</a>
Tab Key	N/A	N/A	N/A	<a href="#">5-31</a>
Transmit Code ID Character	45	2Dh	None	<a href="#">5-32</a>
Prefix Value	99, 105	63h, 69h	7013 <CR><LF>	<a href="#">5-33</a>
Suffix 1 Value Suffix 2 Value	98, 104 100, 106	62h, 68h 64h, 6Ah	7013 <CR><LF>	<a href="#">5-33</a>
Scan Data Transmission Format	235	EBh	Data As Is	<a href="#">5-34</a>
FN1 Substitution Values	103, 109	67h, 6Dh	7013 <CR><LF>	<a href="#">5-36</a>
Transmit "No Read" Message	94	5E	Disable	<a href="#">5-37</a>
Unsolicited Heartbeat Interval	1118	F8h 04h 5Eh	Disable	<a href="#">5-38</a>
<b>Send Versions</b>				
Software Version	N/A	N/A	N/A	<a href="#">5-39</a>
Serial Number	N/A	N/A	N/A	<a href="#">5-39</a>
Manufacturing Information	N/A	N/A	N/A	<a href="#">5-39</a>
<b>Radio Communications</b>				
Radio Communications Host Types	N/A	N/A	Cradle Bluetooth Classic (Cradle Host)	<a href="#">6-5</a>
Bluetooth Friendly Name	607	F1h 5Fh	N/A	<a href="#">6-10</a>
Discoverable Mode	610	F1h 62h	General	<a href="#">6-11</a>
Wi-Fi Friendly Mode	1299	F8h 05h 77h	Disable	<a href="#">6-12</a>
Wi-Fi Friendly Channel Exclusion	N/A	N/A	Use All Channels	<a href="#">6-12</a>
Radio Output Power	1324	F8h 05h 2Ch	Medium Power Setting	<a href="#">6-14</a>
Link Supervision Timeout	1698	F8h 06h A2h	5 sec	<a href="#">6-15</a>
Bluetooth Radio State	1354	F8h 05h 4Ah	On	<a href="#">6-16</a>
Apple iOS Virtual Keyboard Toggle	1114	F8h 04h 5Ah	Disable	<a href="#">6-16</a>
HID Keyboard Keystroke Delay	N/A	N/A	No Delay (0 msec)	<a href="#">6-18</a>
HID CAPS Lock Override	N/A	N/A	Disable	<a href="#">6-18</a>
HID Ignore Unknown Characters	N/A	N/A	Enable	<a href="#">6-19</a>
Emulate Keypad	N/A	N/A	Enable	<a href="#">6-19</a>

**Table A-1** *Parameter Defaults (Continued)*

Parameter	Parameter Number	SSI Number	Default	Page Number
Fast HID Keyboard	1361	F8h 05h 51h	Enable	<a href="#">6-20</a>
Quick Keypad Emulation	1362	F8h 05h 52h	Enable	<a href="#">6-20</a>
HID Keyboard FN1 Substitution	N/A	N/A	Disable	<a href="#">6-21</a>
HID Function Key Mapping	N/A	N/A	Disable	<a href="#">6-21</a>
Simulated Caps Lock	N/A	N/A	Disable	<a href="#">6-22</a>
Convert Case	N/A	N/A	No Case Conversion	<a href="#">6-22</a>
Reconnect Attempt Beep Feedback	559	F1h 2Fh	Disable	<a href="#">6-23</a>
Reconnect Attempt Interval	558	F1h 2Eh	30 sec	<a href="#">6-24</a>
Auto-Reconnect	604	F1h 5Ch	Auto-Reconnect Immediately	<a href="#">6-25</a>
Beep on Insertion	288	20h	Enable	<a href="#">6-26</a>
Beep on <BEL>	150	96	Enable	<a href="#">6-26</a>
Pairing Modes	542	F1h 1Eh	Unlocked	<a href="#">6-27</a>
Pairing on Contacts	545	F1h 21h	Enable	<a href="#">6-28</a>
Toggle Pairing	1322	F8h 05h 2Ah	Disable	<a href="#">6-29</a>
Connection Maintenance Interval	N/A	N/A	15 Minutes	<a href="#">6-29</a>
Batch Mode	544	F1h 20h	Normal (Do Not Batch Data)	<a href="#">6-32</a>
Persistent Batch Storage	1399	F8h 05h 77h	Disable	<a href="#">6-34</a>
Bluetooth Security Levels	1393	F8h 05h 71h	Low	<a href="#">6-35</a>
Save Bluetooth Connection Information	1743	F8h 06h CFh	Enable	<a href="#">6-39</a>
<b>Signature Capture Preferences</b>				
Signature Capture	93	5Dh	Disable	<a href="#">7-3</a>
Signature Capture File Format Selector	313	F0h 39h	JPEG	<a href="#">7-4</a>
Signature Capture Bits per Pixel (BPP)	314	F0h 3Ah	8 BPP	<a href="#">7-5</a>
Signature Capture Width	366	F4h F0h 6Eh	400	<a href="#">7-6</a>
Signature Capture Height	367	F4h F0h 6Fh	100	<a href="#">7-6</a>
Signature Capture JPEG Quality	421	F0h A5h	65	<a href="#">7-6</a>

Table A-1 Parameter Defaults (Continued)

Parameter	Parameter Number	SSI Number	Default	Page Number
<b>USB Host Parameters</b>				
USB Device Type	N/A	N/A	USB Keyboard HID	8-5
Symbol Native API (SNAPI) Status Handshaking	N/A	N/A	Enable	8-7
Native Firmware Update	N/A	N/A	Disable	8-7
USB Keystroke Delay	N/A	N/A	No Delay	8-8
USB CAPS Lock Override	N/A	N/A	Disable	8-8
Bar Codes With Unknown Characters	N/A	N/A	Enable	8-9
USB Convert Unknown to Code 39	N/A	N/A	Disable	8-9
USB Fast HID	N/A	N/A	Enable	8-10
USB Polling Interval	N/A	N/A	3 msec	8-11
Keypad Emulation	N/A	N/A	Enable	8-13
Quick Keypad Emulation	N/A	N/A	Enable	8-13
Keypad Emulation with Leading Zero	N/A	N/A	Enable	8-14
USB Keyboard FN1 Substitution	N/A	N/A	Disable	8-14
Function Key Mapping	N/A	N/A	Disable	8-15
Simulated Caps Lock	N/A	N/A	Disable	8-15
Convert Case	N/A	N/A	None	8-16
USB Static CDC	N/A	N/A	Enable	8-16
CDC Beep on <BEL>	N/A	N/A	Enable	8-17
USB CDC Host Variant	1713	N/A	CDC Standard	8-17
TGCS (IBM) USB Direct I/O Beep	N/A	N/A	Honor	8-19
TGCS (IBM) USB Beep Directive	N/A	N/A	Ignore	8-20
TGCS (IBM) USB Bar Code Configuration Directive	N/A	N/A	Ignore	8-20
TGCS (IBM) USB Specification Version	N/A	N/A	Version 2.2	8-21
<b>SSI Host Parameters</b>				
Select SSI Host	N/A	N/A	N/A	9-12



**Table A-1** *Parameter Defaults (Continued)*

Parameter	Parameter Number	SSI Number	Default	Page Number
Baud Rate	156	9Ch	9600	<a href="#">9-12</a>
Parity	158	9Eh	None	<a href="#">9-14</a>
Check Parity	151	97h	Disable	<a href="#">9-15</a>
Stop Bits	157	9Dh	1	<a href="#">9-15</a>
Software Handshaking	159	9Fh	ACK/NAK	<a href="#">9-16</a>
Host RTS Line State	154	9Ah	Low	<a href="#">9-17</a>
Decode Data Packet Format	238	EEh	Send Raw Decode Data	<a href="#">9-17</a>
Host Serial Response Timeout	155	9Bh	2 Seconds	<a href="#">9-18</a>
Host Character Timeout	239	EFh	200 msec	<a href="#">9-19</a>
Multipacket Option	334	F0h 4Eh	Option 1	<a href="#">9-20</a>
Interpacket Delay	335	F0h 4Fh	0 msec	<a href="#">9-21</a>
<b>Event Reporting</b>				
Decode Event	256	F0h 00h	Disable	<a href="#">9-22</a>
Boot Up Event	258	F0h 02h	Disable	<a href="#">9-23</a>
Parameter Event	259	F0h 03h	Disable	<a href="#">9-23</a>
<b>RS-232 Host Parameters</b>				
RS-232 Host Types	N/A	N/A	Standard	<a href="#">10-6</a>
Baud Rate	N/A	N/A	9600	<a href="#">10-8</a>
Parity	N/A	N/A	None	<a href="#">10-9</a>
Stop Bits	N/A	N/A	1 Stop Bit	<a href="#">10-9</a>
Data Bits	N/A	N/A	8-bit	<a href="#">10-10</a>
Check Receive Errors	N/A	N/A	Enable	<a href="#">10-10</a>
Hardware Handshaking	N/A	N/A	None	<a href="#">10-11</a>
Software Handshaking	N/A	N/A	None	<a href="#">10-13</a>
Host Serial Response Timeout	N/A	N/A	2 Sec	<a href="#">10-15</a>
RTS Line State	N/A	N/A	Low RTS	<a href="#">10-16</a>
Beep on <BEL>	N/A	N/A	Disable	<a href="#">10-16</a>
Intercharacter Delay	N/A	N/A	0 msec	<a href="#">10-17</a>
Nixdorf Beep/LED Options	N/A	N/A	Normal Operation	<a href="#">10-18</a>

Table A-1 Parameter Defaults (Continued)

Parameter	Parameter Number	SSI Number	Default	Page Number
Bar Codes with Unknown Characters	N/A	N/A	Send Bar Code With Unknown Characters	<a href="#">10-18</a>
<b>IBM 468X/469X Host Parameters</b>				
Port Address	N/A	N/A	None	<a href="#">11-4</a>
Convert Unknown to Code 39	N/A	N/A	Disable	<a href="#">11-5</a>
RS-485 Beep Directive	N/A	N/A	Ignore	<a href="#">11-5</a>
RS-485 Bar Code Configuration Directive	N/A	N/A	Ignore	<a href="#">11-6</a>
IBM-485 Specification Version	N/A	N/A	Original Specification	<a href="#">11-6</a>
<b>Keyboard Wedge Host Parameters</b>				
Keyboard Wedge Host Type	N/A	N/A	IBM AT Notebook	<a href="#">12-4</a>
Bar Codes with Unknown Characters	N/A	N/A	Send Bar Codes with Unknown Characters	<a href="#">12-4</a>
Keystroke Delay	N/A	N/A	No Delay	<a href="#">12-5</a>
Intra-keystroke Delay	N/A	N/A	Disable	<a href="#">12-5</a>
Alternate Numeric Keypad Emulation	N/A	N/A	Enable	<a href="#">12-6</a>
Quick Keypad Emulation	N/A	N/A	Enable	<a href="#">12-6</a>
Simulated Caps Lock	N/A	N/A	Disable	<a href="#">12-7</a>
Caps Lock Override	N/A	N/A	Disable	<a href="#">12-7</a>
Convert Case	N/A	N/A	Do Not Convert	<a href="#">12-8</a>
Function Key Mapping	N/A	N/A	Disable	<a href="#">12-8</a>
FN1 Substitution	N/A	N/A	Disable	<a href="#">12-9</a>
Send Make and Break	N/A	N/A	Send	<a href="#">12-9</a>
<b>Symbologies</b>				
<b>Enable/Disable All Code Types</b>				<a href="#">13-8</a>
<b>1D Symbologies</b>				
<b>UPC/EAN/JAN</b>				
UPC-A	1	01h	Enable	<a href="#">13-9</a>
UPC-E	2	02h	Enable	<a href="#">13-9</a>
UPC-E1	12	0Ch	Disable	<a href="#">13-10</a>

**Table A-1** *Parameter Defaults (Continued)*

Parameter	Parameter Number	SSI Number	Default	Page Number
EAN-8/JAN 8	4	04h	Enable	<a href="#">13-10</a>
EAN-13/JAN 13	3	03h	Enable	<a href="#">13-11</a>
Bookland EAN	83	53h	Disable	<a href="#">13-11</a>
Bookland ISBN Format	576	F1h 40h	ISBN-10	<a href="#">13-12</a>
ISSN EAN	617	F1h 69h	Disable	<a href="#">13-12</a>
Decode UPC/EAN/JAN Supplementals (2 and 5 digits)	16	10h	Ignore	<a href="#">13-13</a>
User-Programmable Supplementals			000	<a href="#">13-16</a>
Supplemental 1:	579	F1h 43h		
Supplemental 2:	580	F1h 44h		
UPC/EAN/JAN Supplemental Redundancy	80	50h	10	<a href="#">13-16</a>
Decode UPC/EAN/JAN Supplemental AIM ID Format	672	F1h A0h	Combined	<a href="#">13-17</a>
Transmit UPC-A Check Digit	40	28h	Enable	<a href="#">13-18</a>
Transmit UPC-E Check Digit	41	29h	Enable	<a href="#">13-18</a>
Transmit UPC-E1 Check Digit	42	2Ah	Enable	<a href="#">13-19</a>
Transmit Ean-8 Check Digit	1881	F8 07 59h	Enable	<a href="#">13-19</a>
Transmit Ean-13 Check Digit	1882	F8 07 5Ah	Enable	<a href="#">13-20</a>
UPC-A Preamble	34	22h	System Character	<a href="#">13-21</a>
UPC-E Preamble	35	23h	System Character	<a href="#">13-22</a>
UPC-E1 Preamble	36	24h	System Character	<a href="#">13-23</a>
Convert UPC-E to UPC-A	37	25h	Disable	<a href="#">13-24</a>
Convert UPC-E1 to UPC-A	38	26h	Disable	<a href="#">13-24</a>
EAN/JAN Zero Extend	39	27h	Disable	<a href="#">13-25</a>
UCC Coupon Extended Code	85	55h	Disable	<a href="#">13-25</a>
Coupon Report	730	F1h DAh	New Coupon Format	<a href="#">13-26</a>
UPC Reduced Quiet Zone	1289	F8h 05h 09h	Disable	<a href="#">13-26</a>
<b>Code 128</b>				
Code 128	8	08h	Enable	<a href="#">13-27</a>

**Table A-1** *Parameter Defaults (Continued)*

Parameter	Parameter Number	SSI Number	Default	Page Number
Set Lengths for Code 128	209, 210	D1h, D2h	1 - 55	<a href="#">13-27</a>
GS1-128 (formerly UCC/EAN-128)	14	0Eh	Enable	<a href="#">13-28</a>
ISBT 128	84	54h	Disable	<a href="#">13-29</a>
ISBT Concatenation	577	F1h 41h	Disable	<a href="#">13-30</a>
Check ISBT Table	578	F1h 42h	Enable	<a href="#">13-31</a>
ISBT Concatenation Redundancy	223	DFh	10	<a href="#">13-31</a>
Code 128 <FNC4>	1254	F8h 04h E6h	Honor	<a href="#">13-32</a>
Code 128 Security Level	751	F1h EFh	Security Level 1	<a href="#">13-32</a>
Code 128 Reduced Quiet Zone	1208	F8h 04h B8h	Disable	<a href="#">13-33</a>
<b>Code 39</b>				
Code 39	0	00h	Enable	<a href="#">13-34</a>
Trioptic Code 39	13	0Dh	Disable	<a href="#">13-34</a>
Convert Code 39 to Code 32 (Italian Pharmacy Code)	86	56h	Disable	<a href="#">13-35</a>
Code 32 Prefix	231	E7h	Disable	<a href="#">13-35</a>
Set Lengths for Code 39	18, 19	12h, 13h	1 - 55	<a href="#">13-36</a>
Code 39 Check Digit Verification	48	30h	Disable	<a href="#">13-37</a>
Transmit Code 39 Check Digit	43	2Bh	Disable	<a href="#">13-38</a>
Code 39 Full ASCII Conversion	17	11h	Disable	<a href="#">13-38</a>
Code 39 Security Level	750	F1h EEh	Security Level 1	<a href="#">13-39</a>
Code 39 Reduced Quiet Zone	1209	F8h 04h B9h	Disable	<a href="#">13-41</a>
<b>Code 93</b>				
Code 93	9	09h	Enable	<a href="#">13-41</a>
Set Lengths for Code 93	26, 27	1Ah, 1Bh	1 - 55	<a href="#">13-42</a>
<b>Code 11</b>				
Code 11	10	0Ah	Disable	<a href="#">13-44</a>
Set Lengths for Code 11	28, 29	1Ch, 1Dh	4 to 55	<a href="#">13-44</a>
Code 11 Check Digit Verification	52	34h	Disable	<a href="#">13-46</a>
Transmit Code 11 Check Digit(s)	47	2Fh	Disable	<a href="#">13-47</a>

**Table A-1** *Parameter Defaults (Continued)*

Parameter	Parameter Number	SSI Number	Default	Page Number
<b>Interleaved 2 of 5 (ITF)</b>				
Interleaved 2 of 5 (ITF)	6	06h	Enable	<a href="#">13-47</a>
Set Lengths for I 2 of 5	22, 23	16h, 17h	6 to 55	<a href="#">13-48</a>
I 2 of 5 Check Digit Verification	49	31h	Disable	<a href="#">13-50</a>
Transmit I 2 of 5 Check Digit	44	2Ch	Disable	<a href="#">13-51</a>
Convert I 2 of 5 to EAN-13	82	52h	Disable	<a href="#">13-51</a>
Febraban	1750	F8h 06h D6h	Disable	<a href="#">13-52</a>
I 2 of 5 Security Level	1121	F8h 04h 61h	Security Level 1	<a href="#">13-53</a>
I 2 of 5 Reduced Quiet Zone	1210	F8h 04h BAh	Disable	<a href="#">13-54</a>
<b>Discrete 2 of 5 (DTF)</b>				
Discrete 2 of 5	5	05h	Disable	<a href="#">13-54</a>
Set Lengths for Discrete 2 of 5	20, 21	14h 15h	1 to 55	<a href="#">13-55</a>
<b>Codabar (NW - 7)</b>				
Codabar	7	07h	Enable	<a href="#">13-57</a>
Set Lengths for Codabar	24, 25	18h, 19h	4 to 55	<a href="#">13-57</a>
CLSI Editing	54	36h	Disable	<a href="#">13-59</a>
NOTIS Editing	55	37h	Disable	<a href="#">13-59</a>
Codabar Upper or Lower Case Start/ Stop Characters Detection	855	F2h 57h	Upper Case	<a href="#">13-60</a>
Codabar Mod 16 Check Digit	1784	F8h 06h F8h	Disable	<a href="#">13-60</a>
Transmit Codabar Check Digit	704	F1h C0h	Disable	<a href="#">13-61</a>
<b>MSI</b>				
MSI	11	0Bh	Disable	<a href="#">13-61</a>
Set Lengths for MSI	30, 31	1Eh, 1Fh	4 to 55	<a href="#">13-62</a>
MSI Check Digits	50	32h	One	<a href="#">13-64</a>
Transmit MSI Check Digit	46	2Eh	Disable	<a href="#">13-64</a>
MSI Check Digit Algorithm	51	33h	Mod 10/Mod 10	<a href="#">13-65</a>
MSI Reduced Quiet Zone	1392	F8h 05h 70h	Disable	<a href="#">13-65</a>

**Table A-1** *Parameter Defaults (Continued)*

Parameter	Parameter Number	SSI Number	Default	Page Number
<b>Chinese 2 of 5</b>				
Chinese 2 of 5	408	F0h 98h	Disable	<a href="#">13-66</a>
<b>Matrix 2 of 5</b>				
Matrix 2 of 5	618	F1h 6Ah	Disable	<a href="#">13-66</a>
Set Lengths for Matrix 2 of 5 Lengths	619 620	F1h 6Bh F1h 6Ch	4 to 55	<a href="#">13-67</a>
Matrix 2 of 5 Check Digit	622	F1h 6Eh	Disable	<a href="#">13-68</a>
Transmit Matrix 2 of 5 Check Digit	623	F1h 6Fh	Disable	<a href="#">13-69</a>
<b>Korean 3 of 5</b>				
Korean 3 of 5	581	F1h 45h	Disable	<a href="#">13-69</a>
<b>Inverse 1D</b>	586	F1h 4Ah	Regular	<a href="#">13-70</a>
<b>GS1 DataBar</b>				
GS1 DataBar Omnidirectional (formerly GS1 DataBar-14), GS1 DataBar Truncated, GS1 DataBar Stacked, GS1 DataBar Stacked Omnidirectional	338	F0h 52h	Enable	<a href="#">13-71</a>
GS1 DataBar Limited	339	F0h 53h	Enable	<a href="#">13-71</a>
GS1 DataBar Expanded, GS1 DataBar Expanded Stacked	340	F0h 54h	Enable	<a href="#">13-72</a>
Convert GS1 DataBar to UPC/EAN/JAN	397	F0h 8Dh	Disable	<a href="#">13-72</a>
GS1 DataBar Limited Margin Check	728	F1h D8h	Level 3	<a href="#">13-73</a>
GS1 DataBar Security Level	1706	F8h 06h AAh	Level 1	<a href="#">13-74</a>
<b>Symbology-Specific Security Features</b>				
Redundancy Level	78	4Eh	1	<a href="#">13-75</a>
Security Level	77	4Dh	1	<a href="#">13-77</a>
1D Quiet Zone Level	1288	F8h 05h 08h	1	<a href="#">13-78</a>
Intercharacter Gap Size	381	F0h 7Dh	Normal	<a href="#">13-79</a>
<b>Composite Codes</b>				
Composite CC-C	341	F0h 55h	Disable	<a href="#">13-79</a>
Composite CC-A/B	342	F0h 56h	Disable	<a href="#">13-80</a>

**Table A-1** *Parameter Defaults (Continued)*

Parameter	Parameter Number	SSI Number	Default	Page Number
Composite TLC-39	371	F0h 73h	Disable	<a href="#">13-80</a>
Composite Inverse	1113	F8h 04h 59h	Regular Only	<a href="#">13-81</a>
UPC Composite Mode	344	F0h 58h	UPC Never Linked	<a href="#">13-82</a>
Composite Beep Mode	398	F0h 8Eh	Beep As Each Code Type is Decoded	<a href="#">13-83</a>
GS1-128 Emulation Mode for UCC/EAN Composite Codes	427	F0h ABh	Disable	<a href="#">13-83</a>
<b>2D Symbolologies</b>				
PDF417	15	0Fh	Enable	<a href="#">13-84</a>
MicroPDF417	227	E3h	Disable	<a href="#">13-84</a>
Code 128 Emulation	123	7Bh	Disable	<a href="#">13-85</a>
Data Matrix	292	F0h 24h	Enable	<a href="#">13-86</a>
GS1 Data Matrix	1336	F8h 05h 38h	Disable	<a href="#">13-86</a>
Data Matrix Inverse	588	F1h 4Ch	Inverse Autodetect	<a href="#">13-87</a>
Decode Data Matrix Mirror Images	537	F1h 19h	Auto	<a href="#">13-88</a>
Maxicode	294	F0h 26h	Disable	<a href="#">13-89</a>
QR Code	293	F0h 25h	Enable	<a href="#">13-89</a>
GS1 QR	1343	F8h 05h 3Fh	Disable	<a href="#">13-90</a>
MicroQR	573	F1h 3Dh	Enable	<a href="#">13-90</a>
Weblink QR	1947	F8 07 9Bh	Enable	<a href="#">13-91</a>
Linked QR	1847	737h	Linked QR Only	<a href="#">13-92</a>
Aztec	574	F1h 3Eh	Enable	<a href="#">13-93</a>
Aztec Inverse	589	F1h 4Dh	Inverse Autodetect	<a href="#">13-93</a>
Han Xin	1167	F8h 04h 8Fh	Disable	<a href="#">13-94</a>
Han Xin Inverse	1168	F8h 04h 90h	Regular	<a href="#">13-94</a>
Grid Matrix	1718	F8 06 B6	Disable	<a href="#">13-95</a>
Grid Matrix Inverse	1719	F8 06 B7	Regular Only	<a href="#">13-95</a>
Grid Matrix Mirror	1736	F8 06 C8	Regular Only	<a href="#">13-96</a>
DotCode	1906	F8 07 72h	Disable	<a href="#">13-97</a>
DotCode Inverse	1907	F8 07 73h	Autodetect	<a href="#">13-98</a>

**Table A-1** *Parameter Defaults (Continued)*

<b>Parameter</b>	<b>Parameter Number</b>	<b>SSI Number</b>	<b>Default</b>	<b>Page Number</b>
DotCode Mirrored	1908	F8 07 74h	Autodetect	<a href="#">13-99</a>
DotCode Prioritize	1937	F8 07 91h	Enable	<a href="#">13-100</a>
DotCode Erasure Limit	2063	F8 08 0F	10	<a href="#">13-100</a>
<b>Postal Codes</b>				
US Postnet	89	59h	Disable	<a href="#">13-102</a>
US Planet	90	5Ah	Disable	<a href="#">13-102</a>
Transmit US Postal Check Digit	95	5Fh	Enable	<a href="#">13-103</a>
UK Postal	91	5Bh	Disable	<a href="#">13-103</a>
Transmit UK Postal Check Digit	96	60h	Enable	<a href="#">13-104</a>
Japan Postal	290	F0h 22h	Disable	<a href="#">13-104</a>
Australia Post	291	F0h 23h	Disable	<a href="#">13-105</a>
Australia Post Format	718	F1h CEh	Autodiscriminate	<a href="#">13-106</a>
Netherlands KIX Code	326	F0h 46h	Disable	<a href="#">13-107</a>
USPS 4CB/One Code/Intelligent Mail	592	F1h 50h	Disable	<a href="#">13-107</a>
UPU FICS Postal	611	F1h 63h	Disable	<a href="#">13-108</a>
Mailmark	1337	F8h 05h 39h	Disable	<a href="#">13-108</a>
<b>Country Codes</b>				
USB and Keyboard Wedge Country Keyboard Types	N/A	N/A	US English (North American)	<a href="#">B-2</a>
<b>CJK Decode Control</b>				
CJK Control Parameters	N/A	N/A	Universal Output	<a href="#">D-1</a>





# APPENDIX B COUNTRY CODES

---

## Introduction

This chapter provides instructions for programming the keyboard to interface with a USB or keyboard wedge host. The host powers the scanner. For host setup information, see [Chapter 8, USB Interface](#) and [Chapter 12, Keyboard Wedge Interface](#).

To select a code page for the country keyboard type, see [Appendix B, Country Codes](#).

Throughout the programming bar code menus, default values are indicated with asterisks (\*).

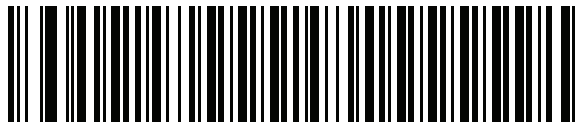

\*Indicates Default — \*US English (North American) — Feature/Option

## USB and Keyboard Wedge Country Keyboard Types (Country Codes)

Scan the bar code corresponding to the keyboard type. For a USB host, this setting applies only to the USB Keyboard (HID) device. If the keyboard type is not listed, see [Keypad Emulation on page 8-13](#) for the USB HID host. For a keyboard wedge host, see [Alternate Numeric Keypad Emulation on page 12-6](#).



**NOTE** When changing USB country keyboard types the digital scanner automatically resets and issues the standard startup beep sequences.



**NOTE** For best results when using international keyboards, enable [Quick Keypad Emulation on page 8-13](#).



- IMPORTANT**
1. Some country keyboard bar code types are specific to certain Windows Operating Systems (i.e., XP, and Win 7 or higher). Bar codes requiring a specific Windows OS are noted so in their bar code captions.
  2. Use the **French International** bar code for Belgian French keyboards.



**\*US English (North American)**

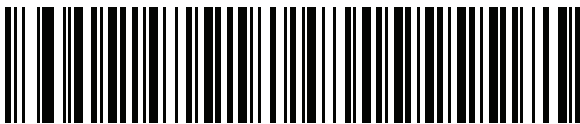

**US English (Mac)**



**Albanian**



**Arabic (101)**

### Country Codes (Continued)

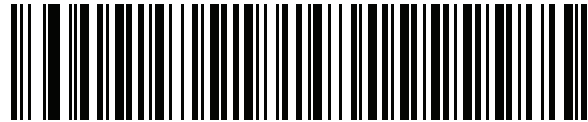

Arabic (102)

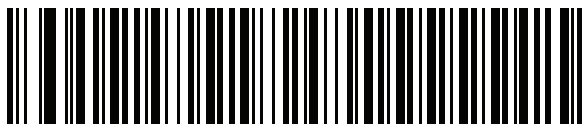

Arabic (102) AZERTY



Azeri (Latin)

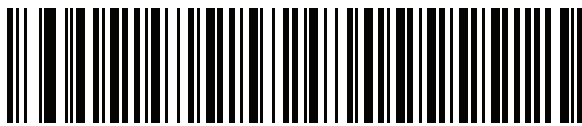

Azeri (Cyrillic)

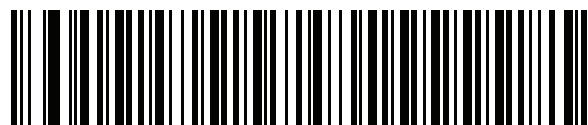

Belarusian

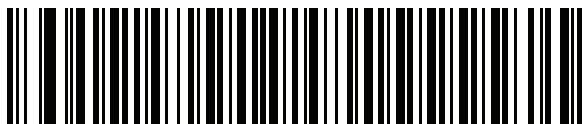

Bosnian (Latin)



Bosnian (Cyrillic)

### Country Codes (Continued)

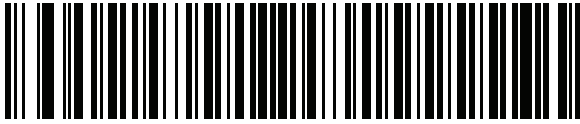

**Bulgarian (Latin)**

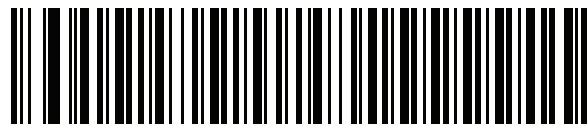

**Bulgarian Cyrillic (Typewriter)  
(Bulgarian -Windows XP  
Typewriter - Win 7 or higher)**

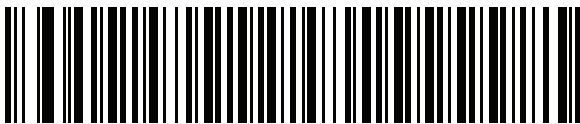

**Canadian French Win7**



**Canadian French (Legacy)**



**Canadian Multilingual Standard**



**Chinese (ASCII)**

## Country Codes (Continued)



**Chinese (Simplified)\***

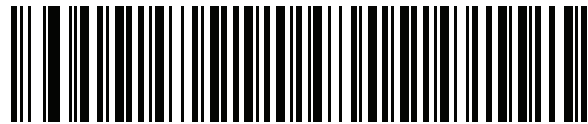

**Chinese (Traditional)\***

\*For CJK keyboard types, see [Appendix D, CJK Decode Control](#).

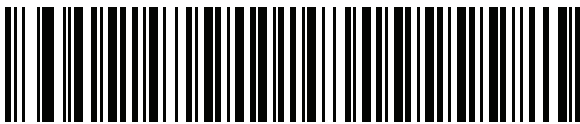

**Croatian**



**Czech**



**Czech (Programmer)**



**Czech (QWERTY)**



**Danish**

### Country Codes (Continued)



Dutch (Netherlands)

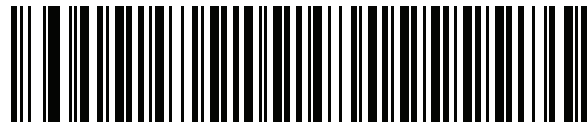

Estonian

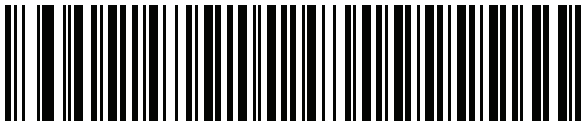

Faeroese

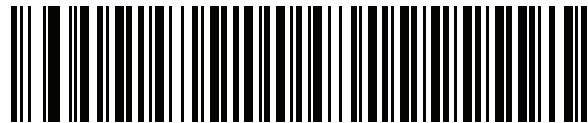

Finnish



French (France)



French International  
(Belgian French)

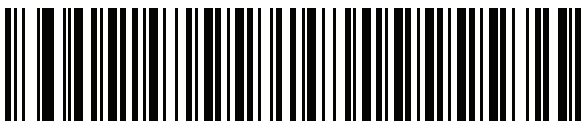

French (Canada) 95/98

## Country Codes (Continued)

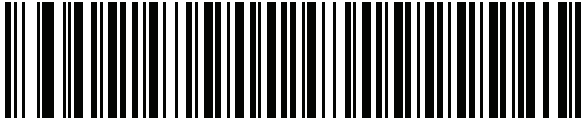

**French (Canada) 2000/XP\***

\*Note that there is also a country code bar code for [Canadian Multilingual Standard on page B-4](#). Be sure to select the appropriate bar code for your host system.

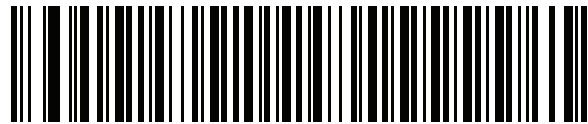

**Galician**



**German**



**Greek Latin**



**Greek (220) Latin**



**Greek (319) Latin**

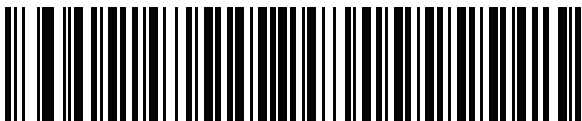

**Greek**



## Country Codes (Continued)

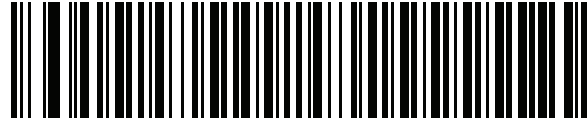

Greek (220)

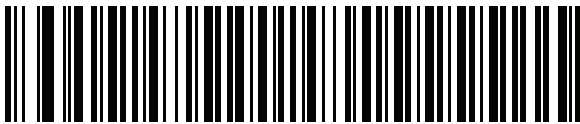

Greek (319)

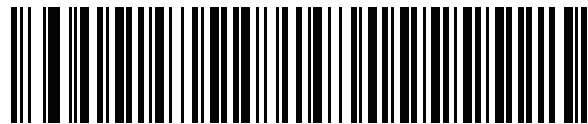

Greek Polytonic

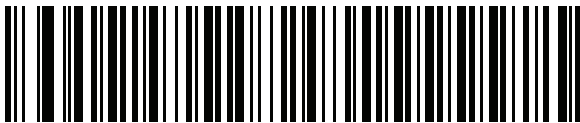

Hebrew Israel

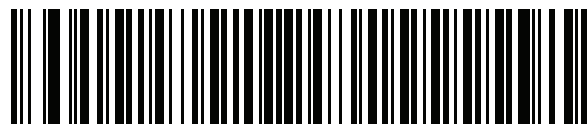

Hungarian

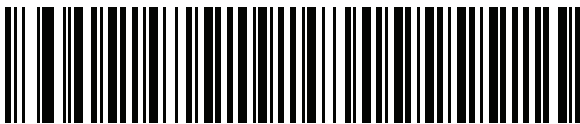

Hungarian\_101KEY



Icelandic

## Country Codes (Continued)

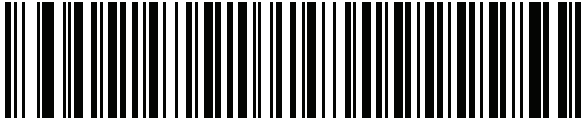

Irish

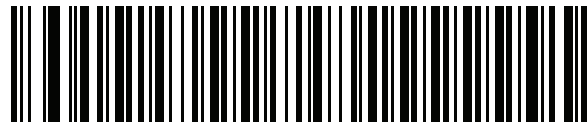

Italian



Italian (142)



Japanese (ASCII)



Japanese (SHIFT-JIS)\*

\*For CJK keyboard types, see [Appendix D, CJK Decode Control](#).



Kazakh



Korean (ASCII)

## Country Codes (Continued)

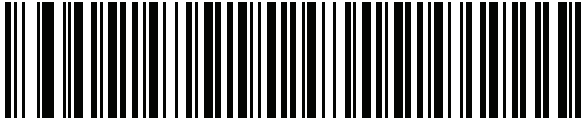

**Korean (Hangul)\***

\*For CJK keyboard types, see [Appendix D, CJK Decode Control](#).

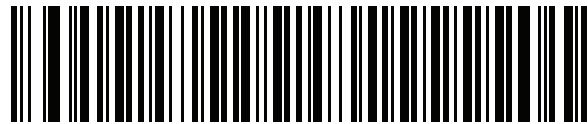

**Kyrgyz**

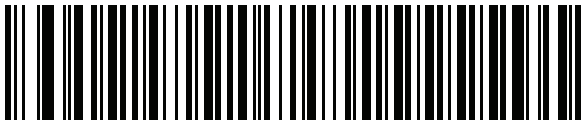

**Latin American**



**Latvian**

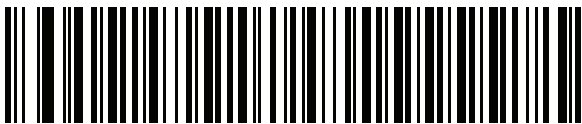

**Latvian (QWERTY)**



**Lithuanian**



**Lithuanian (IBM)**

## Country Codes (Continued)



**Macedonian (FYROM)**

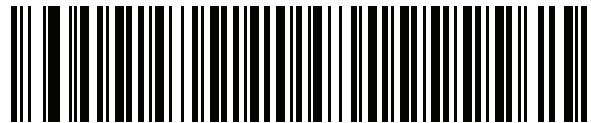

**Maltese\_47KEY**



**Mongolian**



**Norwegian**



**Polish (214)**



**Polish (Programmer)**



**Portuguese (Brazil)  
(Windows XP)**

## Country Codes (Continued)

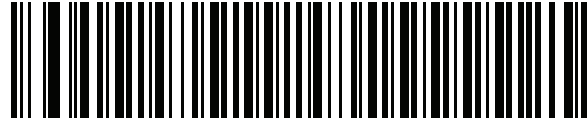

Portuguese (Brazilian ABNT)

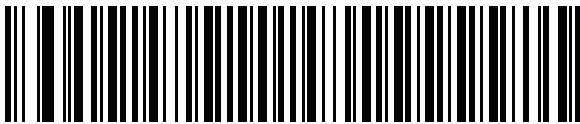

Portuguese (Brazilian ABNT2)

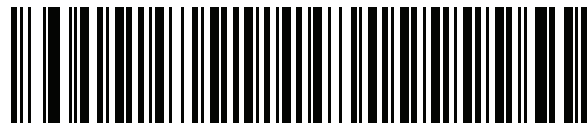

Portuguese (Portugal)



Romanian  
(Windows XP)

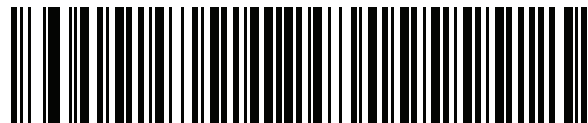

Romanian (Legacy)  
(Win 7 or higher)



Romanian (Standard)  
(Win 7 or higher)

## Country Codes (Continued)

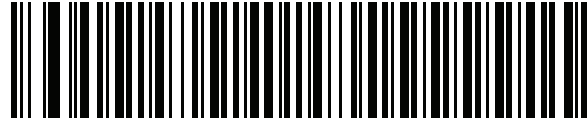

**Romanian (Programmer)  
(Win 7 or higher)**

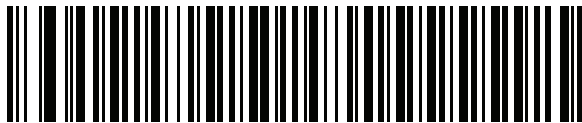

**Russian**



**Russian (Typewriter)**



**Serbian (Latin)**

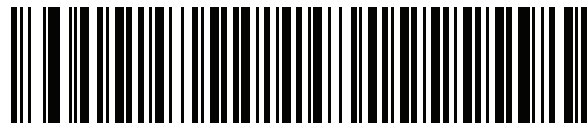

**Serbian (Cyrillic)**



**Slovak**

## Country Codes (Continued)

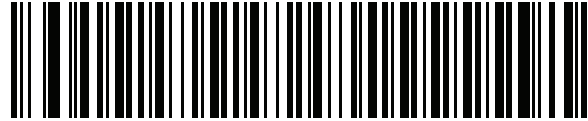

Slovak (QWERTY)

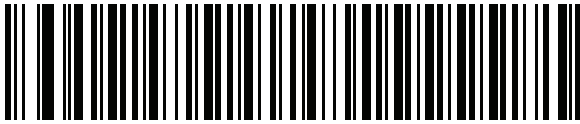

Slovenian

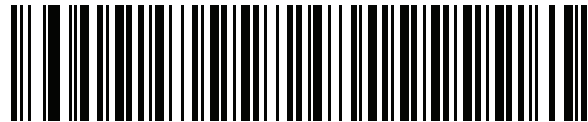

Spanish

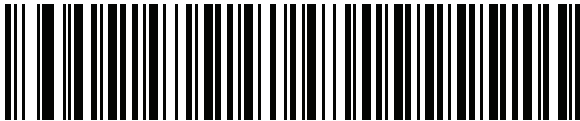

Spanish (Variation)

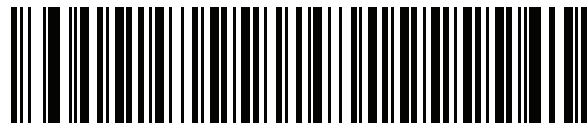

Swedish

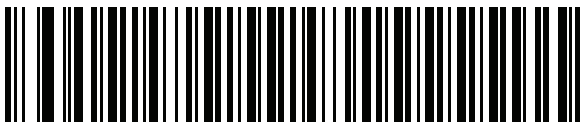

Swiss French

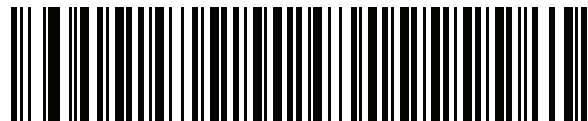

Swiss German

### Country Codes (Continued)



Tatar

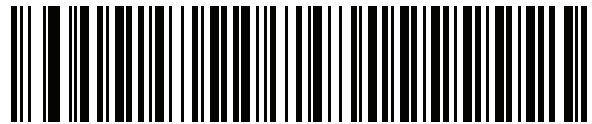

Thai (Kedmanee)



Turkish F



Turkish Q



UK English



Ukrainian



US Dvorak



**Country Codes (Continued)**

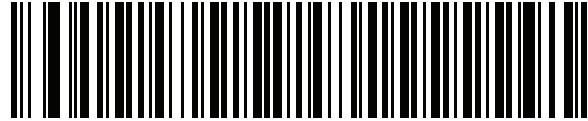

**US Dvorak Left**

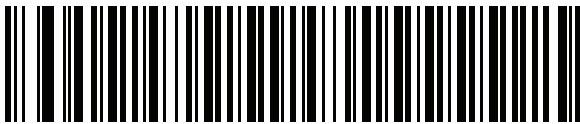

**US Dvorak Right**

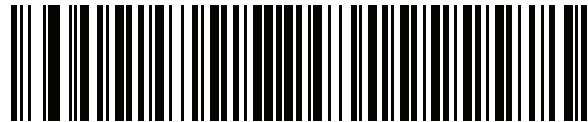

**US International**

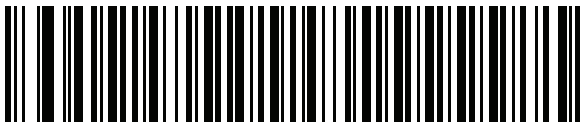

**Uzbek**

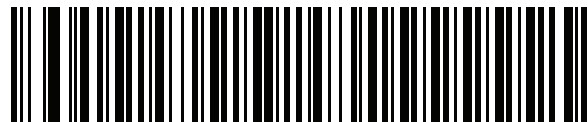

**Vietnamese**

# APPENDIX C COUNTRY CODE PAGES

---

## Introduction

This chapter provides bar codes for selecting code pages for the country keyboard type selected in [Appendix C, Country Code Pages](#). If the default code page in [Table C-1](#) is appropriate for your selected country keyboard type, you do not need to scan a country code page bar code.

✓ **NOTE** ADF rules can also specify a code page based on the symbology and other ADF criteria. Refer to the *Advanced Data Formatting Programmer Guide*.

---

## Country Code Page Defaults

[Table C-1](#) lists the code page default for each country keyboard.

**Table C-1** *Country Code Page Defaults*

Country Keyboard	Code Page Default
US English (North American)	Windows 1252
US English (Mac)	Mac CP10000
Albanian	Windows 1250
Arabic 101	Windows 1256
Arabic 102	Windows 1256
Arabic 102 AZERTY	Windows 1256
Azeri Latin	Windows 1254
Azeri Cyrillic	Windows 1251
Belarusian	Windows 1251
Bosnian Latin	Windows 1250

**Table C-1** Country Code Page Defaults (Continued)

Country Keyboard	Code Page Default
Bosnian Cyrillic	Windows 1251
Bulgarian Latin	Windows 1250
Bulgarian Cyrillic	Windows 1251
Canadian French Win7	Windows 1252
Canadian French (Legacy)	Windows 1252
Canadian Multilingual	Windows 1252
Croatian	Windows 1250
Chinese ASCII	Windows 1252
Chinese (Simplified)	Windows 936, GBK
Chinese (Traditional)	Windows 950, Big5
Czech	Windows 1250
Czech Programmers	Windows 1250
Czech QWERTY	Windows 1250
Danish	Windows 1252
Dutch Netherland	Windows 1252
Estonian	Windows 1257
Faeroese	Windows 1252
Finnish	Windows 1252
French (France)	Windows 1252
French (Canada) 95/98	Windows 1252
French (Canada) 2000/XP	Windows 1252
French International (Belgian French)	Windows 1252
Galician	Windows 1252
German	Windows 1252
Greek Latin	Windows 1252
Greek220 Latin	Windows 1253
Greek319 Latin	Windows 1252
Greek	Windows 1253
Greek220	Windows 1253
Greek319	Windows 1253

**Table C-1** Country Code Page Defaults (Continued)

Country Keyboard	Code Page Default
Greek Polytonic	Windows 1253
Hebrew Israel	Windows 1255
Hungarian	Windows 1250
Hungarian_101KEY	Windows 1250
Icelandic	Windows 1252
Irish	Windows 1252
Italian	Windows 1252
Italian_142	Windows 1252
Japanese ASCII	Windows 1252
Japanese (Shift-JIS)	Windows 932, Shift-JIS
Kazakh	Windows 1251
Korean ASCII	Windows 1252
Korean (Hangul)	Windows 949, Hangul
Kyrgyz Cyrillic	Windows 1251
Latin America	Windows 1252
Latvian	Windows 1257
Latvian QWERTY	Windows 1257
Lithuanian	Windows 1257
Lithuanian_IBM	Windows 1257
Macedonian -FYROM	Windows 1251
Maltese_47KEY	Windows 1252
Mongolian-Cyrillic	Windows 1251
Norwegian	Windows 1252
Polish_214	Windows 1250
Polish Programmer	Windows 1250
Portuguese Brazil	Windows 1252
Portuguese Brazilian ABNT	Windows 1252
Portuguese Brazilian ABNT2	Windows 1252
Portuguese Portugal	Windows 1252
Romanian	Windows 1250

**Table C-1** Country Code Page Defaults (Continued)

Country Keyboard	Code Page Default
Romanian Legacy	Windows 1250
Romanian Standard	Windows 1250
Romanian Programmer	Windows 1250
Russian	Windows 1251
Russian Typewriter	Windows 1251
Serbian Latin	Windows 1250
Serbian Cyrillic	Windows 1251
Slovak	Windows 1250
Slovak QWERTY	Windows 1250
Slovenian	Windows 1250
Spanish	Windows 1252
Spanish Variation	Windows 1252
Swedish	Windows 1252
Swiss French	Windows 1252
Swiss German	Windows 1252
Tatar	Windows 1251
Thai-Kedmanee	Windows 874
Turkish F	Windows 1254
Turkish Q	Windows 1254
Ukrainian	Windows 1251
United Kingdom	Windows 1252
United States	Windows 1252
US Dvorak	Windows 1252
US Dvorak Left Hand	Windows 1252
US Dvorak Right Hand	Windows 1252
US International	Windows 1252
Uzbek Cyrillic	Windows 1251
Vietnamese	Windows 1258

---

## Country Code Page Bar Codes

Scan the bar code corresponding to the country keyboard code page.



**Windows 1250**  
Latin 2, Central European

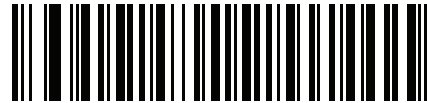

**Windows 1251**  
Cyrillic, Slavic

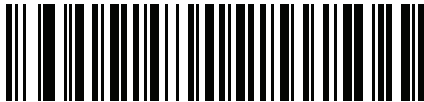

**Windows 1252**  
Latin 1, Western European

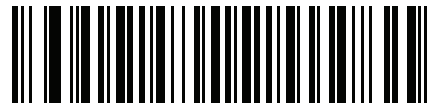

**Windows 1253**  
Greek



**Windows 1254**  
Latin 5, Turkish

## Country Code Pages (Continued)



**Windows 1255  
Hebrew**

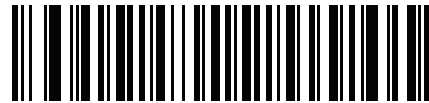

**Windows 1256  
Arabic**

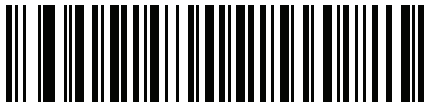

**Windows 1257  
Baltic**

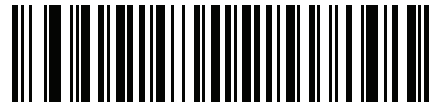

**Windows 1258  
Vietnamese**



**Windows 874  
Thai**

## Country Code Pages (Continued)

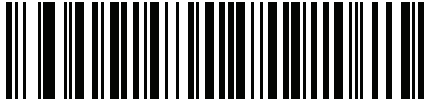

**Windows 20866  
Cyrillic KOI8-R**

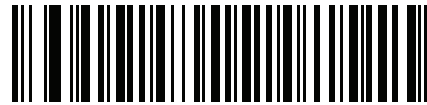

**Windows 932  
Japanese Shift-JIS**



**Windows 936  
Simplified Chinese GBK**

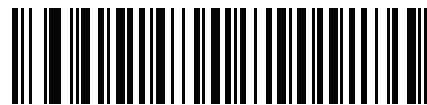

**Windows 54936  
Simplified Chinese GB18030**



**Windows 949  
Korean Hangul**

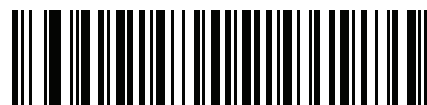

**Windows 950  
Traditional Chinese Big5**



**Country Code Pages (Continued)**



**MS-DOS 437  
Latin US**

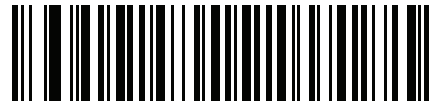

**MS-DOS 737  
Greek**

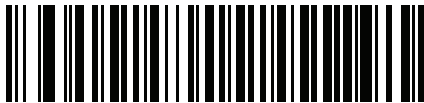

**MS-DOS 775  
Baltic**

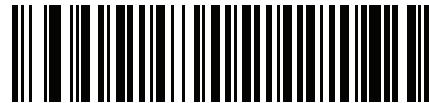

**MS-DOS 850  
Latin 1**

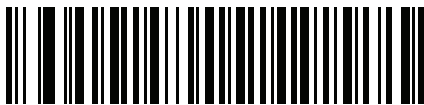

**MS-DOS 852  
Latin 2**

## Country Code Pages (Continued)



**MS-DOS 855**  
**Cyrillic**

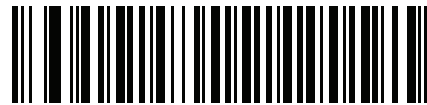

**MS-DOS 857**  
**Turkish**

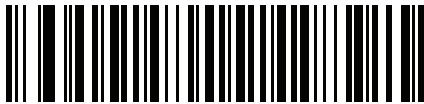

**MS-DOS 860**  
**Portuguese**

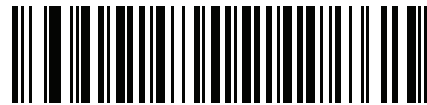

**MS-DOS 861**  
**Icelandic**

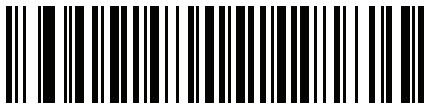

**MS-DOS 862**  
**Hebrew**

**Country Code Pages (Continued)**



**MS-DOS 863  
French Canada**

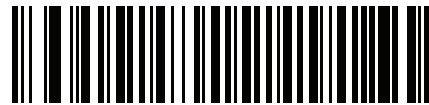

**MS-DOS 865  
Nordic**

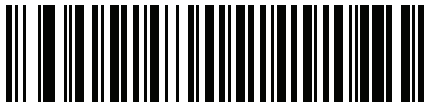

**MS-DOS 866  
Cyrillic**

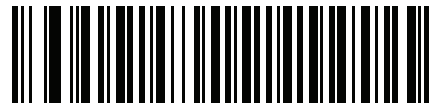

**MS-DOS 869  
Greek 2**

## Country Code Pages (Continued)

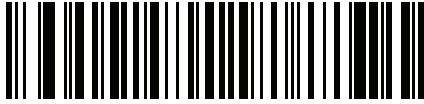

**ISO 8859-1**  
**Latin 1, Western European**

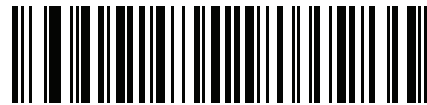

**ISO 8859-2**  
**Latin 2, Central European**

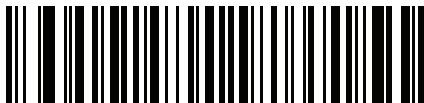

**ISO 8859-3**  
**Latin 3, South European**

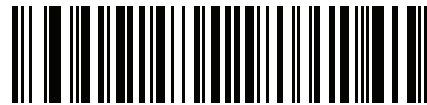

**ISO 8859-4**  
**Latin 4, North European**



**ISO 8859-5**  
**Cyrillic**

## Country Code Pages (Continued)

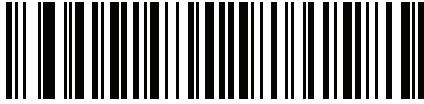

**ISO 8859-6**  
**Arabic**

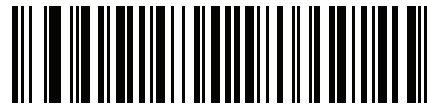

**ISO 8859-7**  
**Greek**

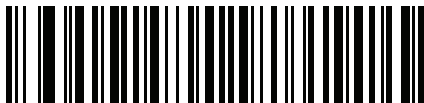

**ISO 8859-8**  
**Hebrew**



**ISO 8859-9**  
**Latin 5, Turkish**



**ISO 8859-10**  
**Latin 6, Nordic**

**Country Code Pages (Continued)**

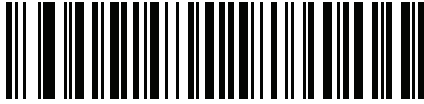

**ISO 8859-11  
Thai**

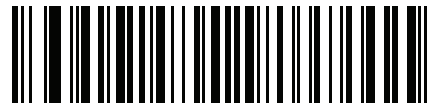

**ISO 8859-13  
Latin 7, Baltic**

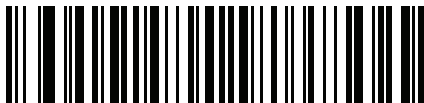

**ISO 8859-14  
Latin 8, Celtic**

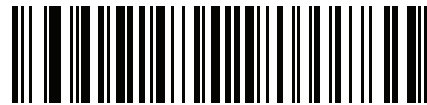

**ISO 8859-15  
Latin 9**



**ISO 8859-16  
Latin 10, South-Eastern European**

**Country Code Pages (Continued)**



**UTF-8**



**UTF-16LE**  
**UTF-16 Little Endian**



**UTF-16BE**  
**UTF-16 Big Endian**

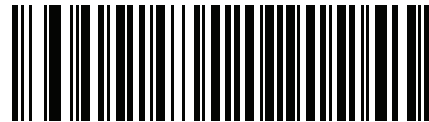

**Mac CP1000**  
**Roman**

# APPENDIX D CJK DECODE CONTROL

---

## Introduction

This appendix describes control parameters for CJK (Chinese, Japanese, Korean) bar code decode through USB HID Keyboard Emulation mode.

- ✓ **NOTE** Because ADF does not support CJK character processing, there is no format manipulation for CJK output.

---

## CJK Control Parameters

### Unicode Output Control

#### Parameter # 973

For a Unicode encoded CJK bar code, select one of the following options for unicode output:

- **Universal Output to Unicode and MBCS Application** - This default method applies to Unicode and MBCS expected applications, such as MS Word and Notepad on a Windows host.
- ✓ **NOTE** To support Unicode universal output, set up the registry table for the Windows host. See [Unicode/CJK Decode Setup with Windows Host on page D-5](#).
- **Output to Unicode Application Only** - This method applies only to Unicode expected applications, such as MS Word and WordPad, but not Notepad.



\*Universal Output  
(0)



Unicode Application Only  
(1)



## CJK Output Method to Windows Host

### Parameter # 972

For a national standard encoded CJK bar code, select one of the following options for CJK output to a Windows host:

- **Universal CJK Output** - This is the default universal CJK output method for US English IME or Chinese/Japanese/Korean ASCII IME on a Windows host. This method converts CJK characters to Unicode and emulates the characters when transmitting to the host. Use the [Unicode Output Control](#) parameter to control Unicode output.
- ✓ **NOTE** To support universal CJK output, set up the registry table for the Windows host. See [Unicode/CJK Decode Setup with Windows Host on page D-5](#).
- **Other options for CJK output** - With the following methods, the scanner sends the CJK character hexadecimal internal code (Nei Ma) value to host, or converts the CJK character to Unicode and sends the hexadecimal Unicode value to host. When using these methods, the Windows host must select the corresponding IME to accept the CJK character. See [Unicode/CJK Decode Setup with Windows Host on page D-5](#).
  - **Japanese Unicode Output**
  - **Simplified Chinese GBK Code Output**
  - **Simplified Chinese Unicode Output**
  - **Korean Unicode Code Output**
  - **Traditional Chinese Big5 Code Output** (Windows XP)
  - **Traditional Chinese Big5 Code Output** (Windows 7)
  - **Traditional Chinese Unicode Code Output** (Windows XP)
  - **Traditional Chinese Unicode Code Output** (Windows 7)

- ✓ **NOTE** The Unicode emulate output method depends on the host system (Windows XP or Windows 7).



\*Universal CJK Output  
(0)



Japanese Unicode Output  
(34)

(for Japanese Unicode Output, select Simplified Chinese Unicode IME on the Windows host)

## CJK Output Method to Windows Host (continued)



**Chinese (Simplified) GBK Output  
(1)**

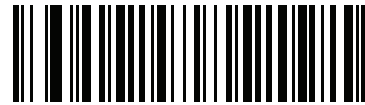

**Chinese (Simplified) Unicode Output  
(2)**

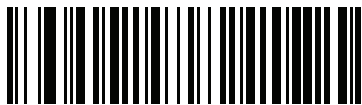

**Korean Unicode Output  
(50)**

(for Korean Unicode Output, select Simplified Chinese Unicode IME on the Windows host)

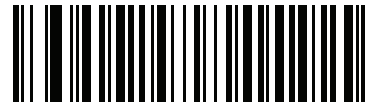

**Chinese (Traditional) Big5 Output (Windows XP)  
(17)**

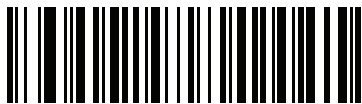

**Chinese (Traditional) Big5 Output (Windows 7)  
(19)**

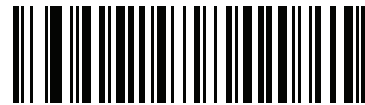

**Chinese (Traditional) Unicode Output (Windows XP)  
(18)**



**Chinese (Traditional) Unicode Output (Windows 7)  
(20)**

## Non-CJK UTF Bar Code Output

### Parameter # 960

Some country keyboard type layouts contain characters that do not exist in the default code page (see [Country Keyboard Type Missing Characters on page D-4](#)). Although the default code page can not encode these characters in a bar code, they can be encoded in the UTF-8 bar code. Scan this parameter bar code to output the Unicode values by emulation mode.

✓ **NOTE** Use this special country keyboard type to decode the non-CJK UTF-8 bar code. After decoding, re-configure the scanner to use the original country keyboard type.

Use US English IME on Windows. See [Unicode Output Control on page D-1](#).



Non-CJK UTF-8 Emulation Output

### Country Keyboard Type Missing Characters

Country keyboard type: **Tatar, Uzbek, Mongolian, Kyrgyz, Kazakh and Azeri**

Default code page: CP1251

Missing characters:

ƒ	F
χ	Χ
κ	Κ
h	h
ϑ	Θ
ϑ	Θ
Υ	Υ
н	Ң
ж	Ж
ƒ	
н	Ң
Ў	Ў
κ	Κ
ч	Ч
к	К

Country keyboard type: **Romanian (Standard)**

Default code page: CP1250

Missing characters:

ș	Ș
ț	Ț

Country keyboard type: **Portuguese-Brazilian (ABNT), Portuguese-Brazilian (ABNT2)**

Default code page: CP1252

Missing character: €

Country keyboard type: **Azeri-Latin**

Default code page: CP1254

Missing characters: ə, Ə

---

## Unicode/CJK Decode Setup with Windows Host

This section describes how to set up CJK decode with a Windows host.

### Setting Up the Windows Registry Table for Unicode Universal Output

To support the Unicode universal output method, set up the Windows host registry table as follows:

1. Select **Start > Run > regedt32** to start the registry editor.
2. Under **HKEY\_Current\_User\Control Panel\Input Method**, set **EnableHexNumpad** to **1** as follows:  
 [HKEY\_CURRENT\_USER\Control Panel\Input Method]  
 "EnableHexNumpad"="1"  
 If this key does not exist, add it as type **REG\_SZ** (string value).
3. Reboot the computer to implement the registry change.

### Adding CJK IME on Windows

To add the desired CJK input language:

1. Click **Start > Control Panel**.
2. If the Control Panel opens in category view, select **Switch to Classic View** in the top left corner.
3. Select **Regional and Language Options**.
4. Click the **Language** tab.

5. Under **Supplemental Language Support**, select the **Install Files for East Asian Languages** check box if not already selected, and click **Apply**. This may require a Windows installation CD to install the required files. This step ensures that the East Asian Languages (CJK) are available.
6. Under **Text Services and Input Language**, click **Details**.
7. Under **Installed Services**, click **Add**.
8. In the **Add Input Language** dialog box, choose the CJK input language and keyboard layout or Input Method Editor (IME) to add.
9. Click **OK** twice. The language indicator appears in the system tray (at bottom right corner of the desktop by default). To switch between input languages (keyboard languages) select the language indicator in the system tray.
10. Select the language indicator in the system tray to select the desired country keyboard type.
11. Verify that the characters displayed on each country's keyboard appear.

## Selecting the Simplified Chinese Input Method on the Host

To select the Simplified Chinese input method:

- Select Unicode/GBK input on Windows XP: **Chinese (Simplified) - NeiMa**, then click the input bar to select **Unicode** or **GBK NeiMa** input.

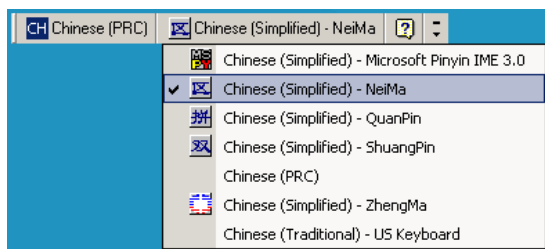

Or



- Select Unicode/GBK input on Windows7: **Chinese (Simplified) - Microsoft Pinyin New Experience Input Style**, then select **Tool Menu > Secondary Inputs > Unicode Input** or **GB Code Input**.

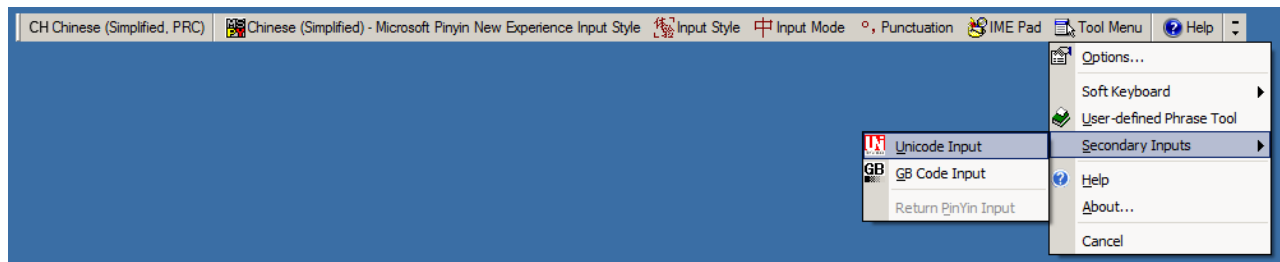

## Selecting the Traditional Chinese Input Method on the Host

To select the Traditional Chinese input method:

- Select Unicode input on Windows XP: **Chinese (Traditional) - Unicode**

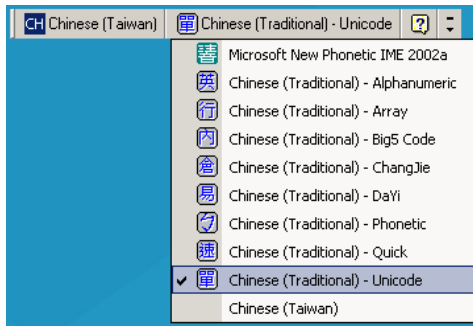

- Select Big5 input on Windows XP: **Chinese (Traditional) - Big5 Code**

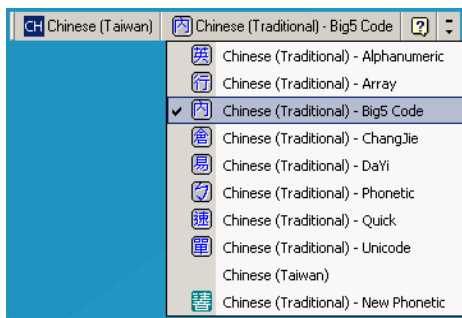

- Select Unicode/Big5 input on Windows 7: **Chinese (Traditional) - New Quick**. This option support both Unicode and Big5 input.





# APPENDIX E PROGRAMMING REFERENCE

---

## Symbol Code Identifiers

**Table E-1** *Symbol Code Characters*

<b>Code Character</b>	<b>Code Type</b>
A	UPC-A, UPC-E, UPC-E1, EAN-8, EAN-13
B	Code 39, Code 32
C	Codabar
D	Code 128, ISBT 128, ISBT 128 Concatenated
E	Code 93
F	Interleaved 2 of 5
G	Discrete 2 of 5, or Discrete 2 of 5 IATA
H	Code 11
J	MSI
K	GS1-128
L	Bookland EAN
M	Trioptic Code 39
N	Coupon Code
R	GS1 DataBar Family
S	Matrix 2 of 5
T	UCC Composite, TLC 39
U	Chinese 2 of 5



**Table E-1** *Symbol Code Characters (Continued)*

<b>Code Character</b>	<b>Code Type</b>
V	Korean 3 of 5
X	ISSN EAN, PDF417, Macro PDF417, Micro PDF417
z	Aztec, Aztec Rune
P00	Data Matrix
P01	QR Code, MicroQR
P02	Maxicode
P03	US Postnet
P04	US Planet
P05	Japan Postal
P06	UK Postal
P08	Netherlands KIX Code
P09	Australia Post
P0A	USPS 4CB/One Code/Intelligent Mail
P0B	UPU FICS Postal
P0C	Mailmark
P0D	Grid Matrix, Grid Matrix Inverse, Grid Matrix Mirror
P0G	GS1 Data Matrix
P0H	Han Xin
P0Q	GS1 QR
P0X	Signature Capture

## AIM Code Identifiers

Each AIM Code Identifier contains the three-character string **jcm** where:

- j = Flag Character (ASCII 93)
- c = Code Character (see [Table E-2](#))
- m = Modifier Character (see [Table E-3](#))

**Table E-2** *Aim Code Characters*

Code Character	Code Type
A	Code 39, Code 39 Full ASCII, Code 32
C	Code 128, ISBT 128, ISBT 128 Concatenated, GS1-128, Coupon (Code 128 portion)
d	Data Matrix, GS1 Data Matrix
E	UPC/EAN, Coupon (UPC portion)
e	GS1 DataBar Family
F	Codabar
G	Code 93
H	Code 11
h	Han Xin
I	Interleaved 2 of 5
L	PDF417, Macro PDF417, Micro PDF417
L2	TLC 39
M	MSI
Q	QR Code, MicroQR, GS1 QR
S	Discrete 2 of 5, IATA 2 of 5
U	Maxicode
z	Aztec, Aztec Rune
X	Bookland EAN, ISSN EAN, Trioptic Code 39, Chinese 2 of 5, Matrix 2 of 5, Korean 3 of 5, US Postnet, US Planet, UK Postal, Japan Postal, Australia Post, Netherlands KIX Code, USPS 4CB/One Code/ Intelligent Mail, UPU FICS Postal, Mailmark, Signature Capture
]g	Grid Matrix, Grid Matrix Inverse, Grid Matrix Mirror

## E - 4 DS2278 Digital Scanner Product Reference Guide

The modifier character is the sum of the applicable option values based on [Table E-3](#).

**Table E-3** *Modifier Characters*

Code Type	Option Value	Option
<b>Code 39</b>	0	No check character or Full ASCII processing.
	1	Reader has checked one check character.
	3	Reader has checked and stripped check character.
	4	Reader has performed Full ASCII character conversion.
	5	Reader has performed Full ASCII character conversion and checked one check character.
	7	Reader has performed Full ASCII character conversion and checked and stripped check character.
	Example: A Full ASCII bar code with check character W, <b>A+I+MI+DW</b> , is transmitted as <b>J</b> <b>A7</b> AIMID where 7 = (3+4).	
<b>Trioptic Code 39</b>	0	No option specified at this time. Always transmit 0.
	Example: A Trioptic bar code 412356 is transmitted as <b>J</b> <b>X0</b> 412356	
<b>Code 128</b>	0	Standard data packet, no Function code 1 in first symbol position.
	1	Function code 1 in first symbol character position.
	2	Function code 1 in second symbol character position.
	Example: A Code (EAN) 128 bar code with Function 1 character <sup>FNC1</sup> in the first position, AIMID is transmitted as <b>J</b> <b>C1</b> AIMID	
<b>I 2 of 5</b>	0	No check digit processing.
	1	Reader has validated check digit.
	3	Reader has validated and stripped check digit.
	Example: An I 2 of 5 bar code without check digit, 4123, is transmitted as <b>J</b> <b>I0</b> 4123	
<b>Codabar</b>	0	No check digit processing.
	1	Reader has checked check digit.
	3	Reader has stripped check digit before transmission.
	Example: A Codabar bar code without check digit, 4123, is transmitted as <b>J</b> <b>F0</b> 4123	
<b>Code 93</b>	0	No options specified at this time. Always transmit 0.
	Example: A Code 93 bar code 012345678905 is transmitted as <b>J</b> <b>G00</b> 12345678905	
<b>MSI</b>	0	Check digits are sent.
	1	No check digit is sent.
	Example: An MSI bar code 4123, with a single check digit checked, is transmitted as <b>J</b> <b>M1</b> 4123	

Table E-3 *Modifier Characters (Continued)*

Code Type	Option Value	Option
<b>D 2 of 5</b>	0	No options specified at this time. Always transmit 0.
		Example: A D 2 of 5 bar code 4123, is transmitted as <b>JS04123</b>
<b>UPC/EAN</b>	0	Standard data packet in full EAN format, i.e. 13 digits for UPC-A, UPC-E, and EAN-13 (not including supplemental data).
	1	Two digit supplemental data only.
	2	Five digit supplemental data only.
	3	Combined data packet comprising 13 digits from EAN-13, UPC-A or UPC-E symbol and 2 or 5 digits from supplemental symbol.
	4	EAN-8 data packet.
		Example: A UPC-A bar code 012345678905 is transmitted as <b>JE00012345678905</b>
<b>Bookland EAN</b>	0	No options specified at this time. Always transmit 0.
		Example: A Bookland EAN bar code 123456789X is transmitted as <b>JX0123456789X</b>
<b>ISSN EAN</b>	0	No options specified at this time. Always transmit 0.
		Example: An ISSN EAN bar code 123456789X is transmitted as <b>JX0123456789X</b>
<b>Code 11</b>	0	Single check digit
	1	Two check digits
	3	Check characters validated but not transmitted.
<b>GS1 DataBar Family</b>		No option specified at this time. Always transmit 0. GS1 DataBar Omnidirectional and GS1 DataBar Limited transmit with an Application Identifier "01". Note: In GS1-128 emulation mode, GS1 DataBar is transmitted using Code 128 rules (i.e., Jc1).
		Example: A GS1 DataBar Omnidirectional bar code 0110012345678902 is transmitted as <b>Je00110012345678902</b> .

Table E-3 *Modifier Characters (Continued)*

Code Type	Option Value	Option
<b>EAN.UCC Composites (GS1 DataBar, GS1-128, 2D portion of UPC composite)</b>		Native mode transmission. Note: UPC portion of composite is transmitted using UPC rules.
	0	Standard data packet.
	1	Data packet containing the data following an encoded symbol separator character.
	2	Data packet containing the data following an escape mechanism character. The data packet does not support the ECI protocol.
	3	Data packet containing the data following an escape mechanism character. The data packet supports the ECI protocol.
		GS1-128 emulation Note: UPC portion of composite is transmitted using UPC rules.
	1	Data packet is a GS1-128 symbol (i.e., data is preceded with ]JC1).
<b>PDF417, Micro PDF417</b>	0	Reader set to conform to protocol defined in 1994 PDF417 symbology specifications. <b>Note:</b> When this option is transmitted, the receiver cannot reliably determine whether ECIs have been invoked or whether data byte 92 <sub>DEC</sub> has been doubled in transmission.
	1	Reader set to follow the ECI protocol (Extended Channel Interpretation). All data characters 92 <sub>DEC</sub> are doubled.
	2	Reader set for Basic Channel operation (no escape character transmission protocol). Data characters 92 <sub>DEC</sub> are not doubled. <b>Note:</b> When decoders are set to this mode, unbuffered Macro symbols and symbols requiring the decoder to convey ECI escape sequences cannot be transmitted.
	3	The bar code contains a GS1-128 symbol, and the first codeword is 903-907, 912, 914, 915.
	4	The bar code contains a GS1-128 symbol, and the first codeword is in the range 908-909.
	5	The bar code contains a GS1-128 symbol, and the first codeword is in the range 910-911.

Table E-3 *Modifier Characters (Continued)*

Code Type	Option Value	Option
<b>Data Matrix</b>	0	ECC 000-140, not supported.
	1	ECC 200.
	2	ECC 200, FNC1 in first or fifth position.
	3	ECC 200, FNC1 in second or sixth position.
	4	ECC 200, ECI protocol implemented.
	5	ECC 200, FNC1 in first or fifth position, ECI protocol implemented.
	6	ECC 200, FNC1 in second or sixth position, ECI protocol implemented.
<b>MaxiCode</b>	0	Symbol in Mode 4 or 5.
	1	Symbol in Mode 2 or 3.
	2	Symbol in Mode 4 or 5, ECI protocol implemented.
	3	Symbol in Mode 2 or 3, ECI protocol implemented in secondary message.
<b>QR Code</b>	0	Model 1 symbol.
	1	Model 2 / MicroQR symbol, ECI protocol not implemented.
	2	Model 2 symbol, ECI protocol implemented.
	3	Model 2 symbol, ECI protocol not implemented, FNC1 implied in first position.
	4	Model 2 symbol, ECI protocol implemented, FNC1 implied in first position.
	5	Model 2 symbol, ECI protocol not implemented, FNC1 implied in second position.
	6	Model 2 symbol, ECI protocol implemented, FNC1 implied in second position.
<b>Aztec</b>	0	Aztec symbol.
	C	Aztec Rune symbol.
<b>Han Xin</b>	0	Generic data, no special features are set. The transmitted data does not follow the AIM ECI protocol.
	1	ECI protocol enabled. There is at least one ECI mode encoded. Transmitted data must follow the AIM ECI protocol.
<b>Grid Matrix, Grid Matrix Inverse, Grid Matrix Mirror</b>	0	No options specified at this time. Always transmit 0.



# APPENDIX F SAMPLE BAR CODES



**IMPORTANT**

To read a sample bar code the parameter must be enabled. To enable a parameter scan the appropriate enable bar code in [Chapter 13, Symbolologies](#).

---

## UPC/EAN

### UPC-A, 100%



### UPC-A with 2-digit Add-on

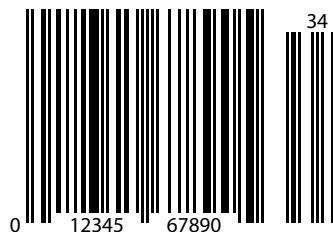



---

## UPC/EAN (continued)

### UPC-A with 5-digit Add-on



### UPC-E



### UPC-E with 2-digit Add-on



---

## UPC/EAN (continued)

### UPC-E with 5-digit Add-on



### EAN-8

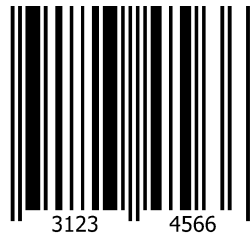

### EAN-13, 100%

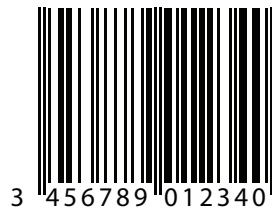

---

## UPC/EAN (continued)

### EAN-13 with 2-digit Add-on



### EAN-13 with 5-digit Add-on



---

**Code 128**



1 2 3 4 5 6 7 8 9 0

**GS1-128**

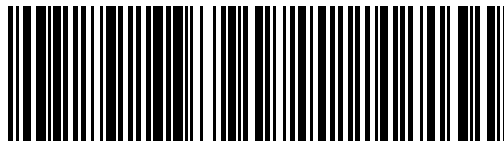

(01)94019097685457(13)170119(30)17

---

**Code 39**

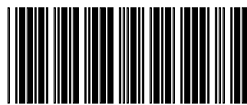

123ABC

---

**Code 93**

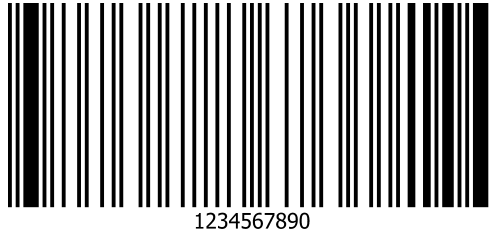

---

**Code 11 with 2 Check Digits**



---

**Interleaved 2 of 5**



---

## MSI with 2 Check Digits



---

## Chinese 2 of 5

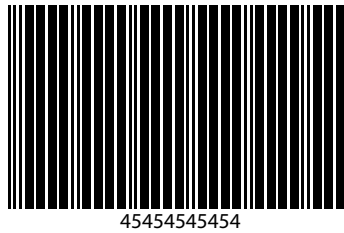

---

## Matrix 2 of 5



---

## Korean 3 of 5



---

## GS1 DataBar

### GS1 DataBar Omnidirectional (formerly GS1 DataBar-14)



7612341562341

### GS1 DataBar Truncated

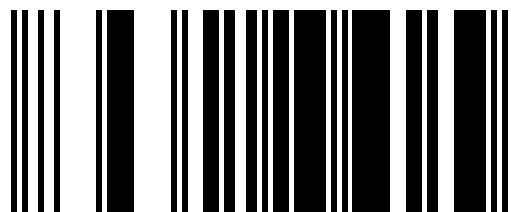

(01)00614141999996

---

## GS1 DataBar (continued)

### GS1 DataBar Stacked

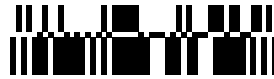

### GS1 DataBar Stacked Omnidirectional

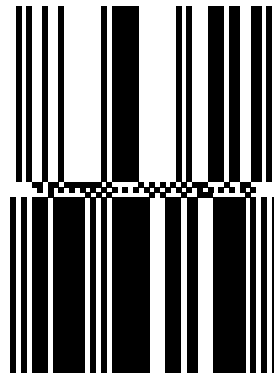

### GS1 DataBar Limited

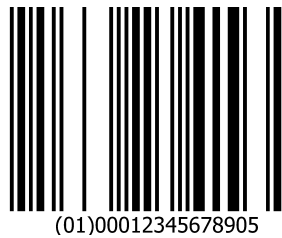



---

## GS1 DataBar (continued)

### GS1 DataBar Expanded

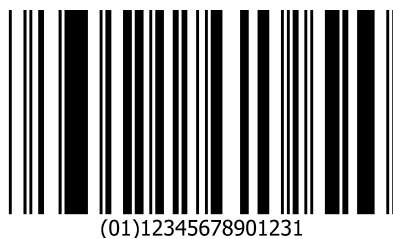

### GS1 DataBar Expanded Stacked



---

## 2D Symbologies

PDF417

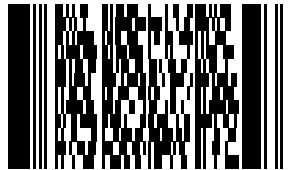

Data Matrix



GS1 Data Matrix



---

## 2D Symbologies (continued)

### Maxicode

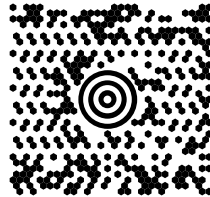

### QR Code



### GS1 QR



---

## 2D Symbologies (continued)

### MicroQR



### Aztec



0123456789ABCDEFGHIJKLMNOPQRSTUVWXYZ0123456789ABCDEFGHIJKLMNOPQRSTUVWXYZ0123456789012345  
6789ABCDEFGHIJKLMNOPQRSTUVWXYZ0123456789ABCDEFGHIJKLMNOPQRSTUVWXYZ0123456789

### Grid Matrix

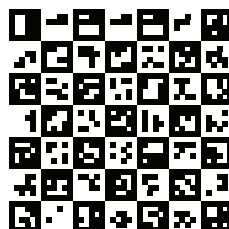

---

## 2D Symbologies (continued)

Han Xin



---

## Postal Codes

US Postnet



UK Postal



---

## Postal Codes (continued)

### Japan Post



### Australian Post





# APPENDIX G NUMERIC BAR CODES

---

## Numeric Bar Codes

For parameters requiring specific numeric values, scan the appropriately numbered bar code(s).

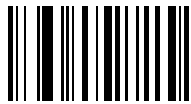

0



1



2



3



---

## Numeric Bar Codes (continued)



4

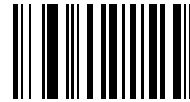

5



6

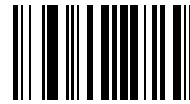

7



8

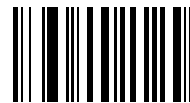

9

---

## Cancel

To correct an error or change a selection, scan the bar code below.



Cancel



# APPENDIX H ALPHAUMERIC BAR CODES

---

## Cancel

To correct an error or change a selection, scan the following bar code.



Cancel

---

## Alphanumeric Bar Codes



Space



#

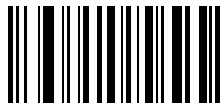

\$

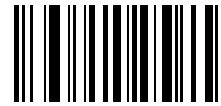

%



\*

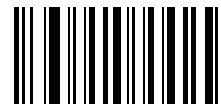

+

---

## Alphanumeric Bar Codes (continued)



-

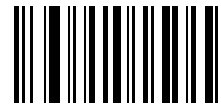

.



/



!



“



&

---

## Alphanumeric Bar Codes (continued)

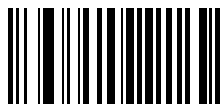

'



(



)



:



;



<

---

## Alphanumeric Bar Codes (continued)

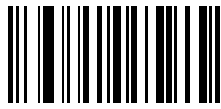

=



>



?

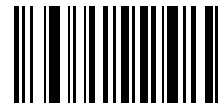

@



[

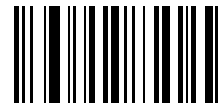

\



---

## Alphanumeric Bar Codes (continued)



1



2

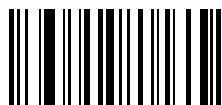

3



4

---

## Alphanumeric Bar Codes (continued)

✓ **NOTE** Do not confuse the following bar codes with those on the numeric keypad.

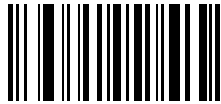

0

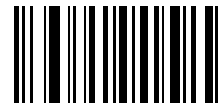

1

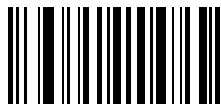

2

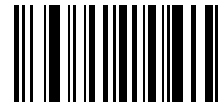

3



4



5

---

## Alphanumeric Bar Codes (continued)

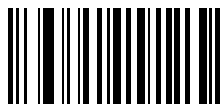

6



7



8



9



End of Message



Cancel

---

Alphanumeric Bar Codes (continued)



A

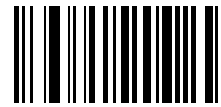

B



C

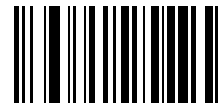

D



E



F

---

## Alphanumeric Bar Codes (continued)

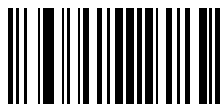

G



H



I



J



K



L

---

Alphanumeric Bar Codes (continued)

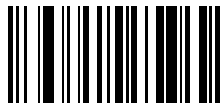

M

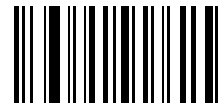

N



O

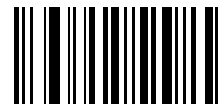

P

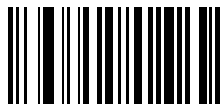

Q



R

---

## Alphanumeric Bar Codes (continued)



5



6

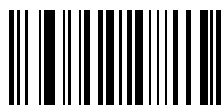

7



8



9



0

---

**Alphanumeric Bar Codes (continued)**

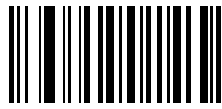

**Y**



**Z**

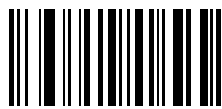

**a**

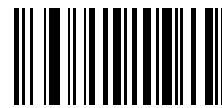

**b**

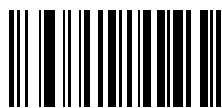

**c**

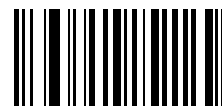

**d**



---

## Alphanumeric Bar Codes (continued)

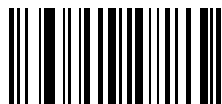

e



f

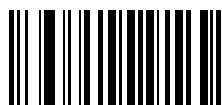

g



h



i



j

---

Alphanumeric Bar Codes (continued)



k

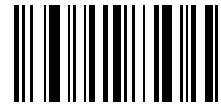

l

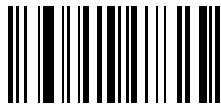

m

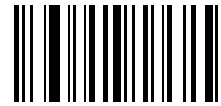

n

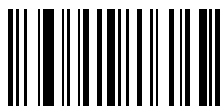

o

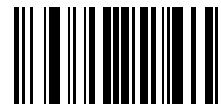

p

---

## Alphanumeric Bar Codes (continued)



q

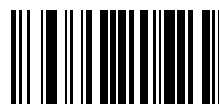

r

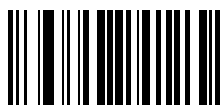

s



t

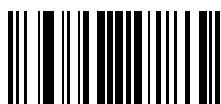

u

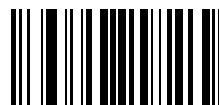

v

---

Alphanumeric Bar Codes (continued)



w



x

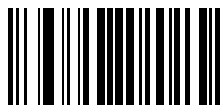

y

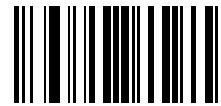

z

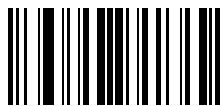

{

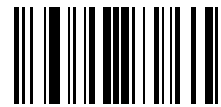

|

---

## Alphanumeric Bar Codes (continued)



}



~

# APPENDIX I ASCII CHARACTER SETS

✓ **NOTE** For the Keyboard Wedge Interface, Code 39 Full ASCII interprets the bar code special character (\$ + % /) preceding a Code 39 character and assigns an ASCII character value to the pair. For example, if you enable Code 39 Full ASCII and scan **+B**, it transmits as **b**, %**J** as **?**, and %**V** as **@**. Scanning **ABC%I** outputs the keystroke equivalent of **ABC >**.

**Table I-1** ASCII Character Set

ASCII Value (Prefix/Suffix Value for RS-232)	Full ASCII Code 39 Encode Char	Keystroke	ASCII Character (Applies to RS-232 Only)
1000	%U	CTRL 2	NUL
1001	\$A	CTRL A	SOH
1002	\$B	CTRL B	STX
1003	\$C	CTRL C	ETX
1004	\$D	CTRL D	EOT
1005	\$E	CTRL E	ENQ
1006	\$F	CTRL F	ACK
1007	\$G	CTRL G	BELL
1008	\$H	CTRL H/ <b>BACKSPACE</b> <sup>1</sup>	BCKSPC
1009	\$I	CTRL I/ <b>HORIZONTAL TAB</b> <sup>1</sup>	HORIZ TAB
1010	\$J	CTRL J	LF/NW LN
1011	\$K	CTRL K	VT
1012	\$L	CTRL L	FF

<sup>1</sup>The keystroke in bold transmits only if you enabled [Function Key Mapping on page 8-15](#) or [page 12-8](#). Otherwise, the unbold keystroke transmits.

Table I-1 ASCII Character Set (Continued)

ASCII Value (Prefix/Suffix Value for RS-232)	Full ASCII Code 39 Encode Char	Keystroke	ASCII Character (Applies to RS-232 Only)
1013	\$M	CTRL M/ <b>ENTER</b> <sup>1</sup>	CR/ENTER
1014	\$N	CTRL N	SO
1015	\$O	CTRL O	SI
1016	\$P	CTRL P	DLE
1017	\$Q	CTRL Q	DC1/XON
1018	\$R	CTRL R	DC2
1019	\$S	CTRL S	DC3/XOFF
1020	\$T	CTRL T	DC4
1021	\$U	CTRL U	NAK
1022	\$V	CTRL V	SYN
1023	\$W	CTRL W	ETB
1024	\$X	CTRL X	CAN
1025	\$Y	CTRL Y	EM
1026	\$Z	CTRL Z	SUB
1027	%A	CTRL [	ESC
1028	%B	CTRL \	FS
1029	%C	CTRL ]	GS
1030	%D	CTRL 6	RS
1031	%E	CTRL -	US
1032	Space	Space	Space
1033	/A	!	!
1034	/B	"	"
1035	/C	#	#
1036	/D	\$	\$
1037	/E	%	%
1038	/F	&	&
1039	/G	'	'

<sup>1</sup>The keystroke in bold transmits only if you enabled *Function Key Mapping* on page 8-15 or page 12-8. Otherwise, the unbold keystroke transmits.

Table I-1 ASCII Character Set (Continued)

ASCII Value (Prefix/Suffix Value for RS-232)	Full ASCII Code 39 Encode Char	Keystroke	ASCII Character (Applies to RS-232 Only)
1040	/H	(	(
1041	/I	)	)
1042	/J	*	*
1043	/K	+	+
1044	/L	,	,
1045	-	-	-
1046	.	.	.
1047	/o	/	/
1048	0	0	0
1049	1	1	1
1050	2	2	2
1051	3	3	3
1052	4	4	4
1053	5	5	5
1054	6	6	6
1055	7	7	7
1056	8	8	8
1057	9	9	9
1058	/Z	:	:
1059	%F	;	;
1060	%G	<	<
1061	%H	=	=
1062	%I	>	>
1063	%J	?	?
1064	%V	@	@
1065	A	A	A
1066	B	B	B

<sup>1</sup>The keystroke in bold transmits only if you enabled *Function Key Mapping on page 8-15 or page 12-8*. Otherwise, the unbold keystroke transmits.



Table I-1 ASCII Character Set (Continued)

ASCII Value (Prefix/Suffix Value for RS-232)	Full ASCII Code 39 Encode Char	Keystroke	ASCII Character (Applies to RS-232 Only)
1067	C	C	C
1068	D	D	D
1069	E	E	E
1070	F	F	F
1071	G	G	G
1072	H	H	H
1073	I	I	I
1074	J	J	J
1075	K	K	K
1076	L	L	L
1077	M	M	M
1078	N	N	N
1079	O	O	O
1080	P	P	P
1081	Q	Q	Q
1082	R	R	R
1083	S	S	S
1084	T	T	T
1085	U	U	U
1086	V	V	V
1087	W	W	W
1088	X	X	X
1089	Y	Y	Y
1090	Z	Z	Z
1091	%K	[	[
1092	%L	\	\
1093	%M	]	]

<sup>1</sup>The keystroke in bold transmits only if you enabled *Function Key Mapping* on page 8-15 or page 12-8. Otherwise, the unbold keystroke transmits.

Table I-1 ASCII Character Set (Continued)

ASCII Value (Prefix/Suffix Value for RS-232)	Full ASCII Code 39 Encode Char	Keystroke	ASCII Character (Applies to RS-232 Only)
1094	%N	^	^
1095	%O	_	_
1096	%W	'	`
1097	+A	<b>a</b>	a
1098	+B	<b>b</b>	b
1099	+C	<b>c</b>	c
1100	+D	<b>d</b>	d
1101	+E	<b>e</b>	e
1102	+F	<b>f</b>	f
1103	+G	<b>g</b>	g
1104	+H	<b>h</b>	h
1105	+I	<b>i</b>	i
1106	+J	<b>j</b>	j
1107	+K	<b>k</b>	k
1108	+L	<b>l</b>	l
1109	+M	<b>m</b>	m
1110	+N	<b>n</b>	n
1111	+O	<b>o</b>	o
1112	+P	<b>p</b>	p
1113	+Q	<b>q</b>	q
1114	+R	<b>r</b>	r
1115	+S	<b>s</b>	s
1116	+T	<b>t</b>	t
1117	+U	<b>u</b>	u
1118	+V	<b>v</b>	v
1119	+W	<b>w</b>	w
1120	+X	<b>x</b>	x

<sup>1</sup>The keystroke in bold transmits only if you enabled *Function Key Mapping* on page 8-15 or page 12-8. Otherwise, the unbold keystroke transmits.

Table I-1 ASCII Character Set (Continued)

ASCII Value (Prefix/Suffix Value for RS-232)	Full ASCII Code 39 Encode Char	Keystroke	ASCII Character (Applies to RS-232 Only)
1121	+Y	<b>y</b>	y
1122	+Z	<b>z</b>	z
1123	%P	<b>{</b>	{
1124	%Q	<b> </b>	
1125	%R	<b>}</b>	}
1126	%S	<b>~</b>	~
1127			Undefined
7013			ENTER

<sup>1</sup>The keystroke in bold transmits only if you enabled [Function Key Mapping on page 8-15](#) or [page 12-8](#). Otherwise, the unbold keystroke transmits.

Table I-2 ALT Key Character Set

ALT Keys	Keystroke
2064	ALT 2
2065	ALT A
2066	ALT B
2067	ALT C
2068	ALT D
2069	ALT E
2070	ALT F
2071	ALT G
2072	ALT H
2073	ALT I
2074	ALT J
2075	ALT K
2076	ALT L
2077	ALT M

**Table I-2** ALT Key Character Set (Continued)

ALT Keys	Keystroke
2078	ALT N
2079	ALT O
2080	ALT P
2081	ALT Q
2082	ALT R
2083	ALT S
2084	ALT T
2085	ALT U
2086	ALT V
2087	ALT W
2088	ALT X
2089	ALT Y
2090	ALT Z

**Table I-3** GUI Key Character Set

GUI Key	Keystroke
3000	Right Control Key
3048	GUI 0
3049	GUI 1
3050	GUI 2
3051	GUI 3
3052	GUI 4
3053	GUI 5
3054	GUI 6
3055	GUI 7
3056	GUI 8
3057	GUI 9

**Note:** GUI Shift Keys - The Apple™ iMac keyboard has an apple key on either side of the space bar. Windows-based systems have a GUI key to the left of the left ALT key, and to the right of the right ALT key.

**Table I-3** GUI Key Character Set (Continued)

GUI Key	Keystroke
3065	GUI A
3066	GUI B
3067	GUI C
3068	GUI D
3069	GUI E
3070	GUI F
3071	GUI G
3072	GUI H
3073	GUI I
3074	GUI J
3075	GUI K
3076	GUI L
3077	GUI M
3078	GUI N
3079	GUI O
3080	GUI P
3081	GUI Q
3082	GUI R
3083	GUI S
3084	GUI T
3085	GUI U
3086	GUI V
3087	GUI W
3088	GUI X
3089	GUI Y
3090	GUI Z

**Note:** GUI Shift Keys - The Apple™ iMac keyboard has an apple key on either side of the space bar. Windows-based systems have a GUI key to the left of the left ALT key, and to the right of the right ALT key.

**Table I-4** *PF Key Character Set*

<b>PF Keys</b>	<b>Keystroke</b>
4001	PF 1
4002	PF 2
4003	PF 3
4004	PF 4
4005	PF 5
4006	PF 6
4007	PF 7
4008	PF 8
4009	PF 9
4010	PF 10
4011	PF 11
4012	PF 12
4013	PF 13
4014	PF 14
4015	PF 15
4016	PF 16

**Table I-5** *F key Character Set*

<b>F Keys</b>	<b>Keystroke</b>
5001	F 1
5002	F 2
5003	F 3
5004	F 4
5005	F 5
5006	F 6
5007	F 7
5008	F 8
5009	F 9
5010	F 10
5011	F 11
5012	F 12
5013	F 13
5014	F 14
5015	F 15
5016	F 16
5017	F 17
5018	F 18
5019	F 19
5020	F 20
5021	F 21
5022	F 22
5023	F 23
5024	F 24

**Table I-6** *Numeric Key Character Set*

<b>Numeric Keypad</b>	<b>Keystroke</b>
6042	*
6043	+
6044	Undefined
6045	-
6046	.
6047	/
6048	0
6049	1
6050	2
6051	3
6052	4
6053	5
6054	6
6055	7
6056	8
6057	9
6058	Enter
6059	Num Lock



**Table I-7** *Extended Key Character Set*

<b>Extended Keypad</b>	<b>Keystroke</b>
7001	Break
7002	Delete
7003	Pg Up
7004	End
7005	Pg Dn
7006	Pause
7007	Scroll Lock
7008	Backspace
7009	Tab
7010	Print Screen
7011	Insert
7012	Home
7013	Enter
7014	Escape
7015	Up Arrow
7016	Dn Arrow
7017	Left Arrow
7018	Right Arrow

# APPENDIX J COMMUNICATION PROTOCOL FUNCTIONALITY

## Functionality Supported via Communication (Cable) Interface

[Table J-1](#) lists supported scanner functionality by communication protocol.

**Table J-1** *Communication Interface Functionality*

Communication Interfaces	Functionality		
	Data Transmission	Remote Management	Image and Video Transmission
<b>USB</b>			
HID Keyboard Emulation	Supported	Not Available	Not Available
Simple COM Port Emulation	Not Available	Not Available	Not Available
SSI over CDC COM Port Emulation	Supported	Supported	Not Available
IBM Table-Top USB	Supported	Supported	Not Available
IBM Hand-Held USB	Supported	Supported	Not Available
USB OPOS Hand-Held	Supported	Supported	Not Available
Symbol Native API (SNAPI) without Imaging Interface	Supported	Supported	Not Available
Symbol Native API (SNAPI) with Imaging Interface	Supported	Supported	Not Available
<b>RS-232</b>			
Standard RS-232	Supported	Not Available	Not Available
ICL RS-232	Supported	Not Available	Not Available
Fujitsu RS-232	Supported	Not Available	Not Available
Wincor-Nixdorf RS-232 Mode A	Supported	Not Available	Not Available
Wincor-Nixdorf RS-232 Mode B	Supported	Not Available	Not Available

**Table J-1** *Communication Interface Functionality (Continued)*

Communication Interfaces	Functionality		
	Data Transmission	Remote Management	Image and Video Transmission
Olivetti ORS4500	Supported	Not Available	Not Available
Omron	Supported	Not Available	Not Available
CUTE	Supported	Not Available	Not Available
OPOS/JPOS	Supported	Not Available	Not Available
SSI	Supported	Supported	Not Available
<b>IBM 4690</b>			
Hand-Held Scanner Emulation (Port 9B)	Supported	Not Available	Not Available
Table-Top Scanner Emulation (Port 17)	Supported	Supported	Not Available
Non-IBM Scanner Emulation (Port 5B)	Supported	Supported	Not Available
<b>Keyboard Wedge</b>			
IBM PC/AT & IBM PC Compatibles	Supported	Not Available	Not Available
IBM AT Notebook	Supported	Not Available	Not Available

# APPENDIX K SIGNATURE CAPTURE CODE

---

## Introduction

CapCode, a signature capture code, is a special pattern that encloses a signature area on a document and allows a scanner to capture a signature.

There are several accepted patterns that allow automatic identification of different signatures on the same form. For example, on the federal tax return 1040 form there are three signature areas, one each for two joint filers, and one for a professional preparer. By using different patterns, a program can correctly identify all three, so they can be captured in any sequence and still be identified correctly.

✓ **NOTE** Although the DS2278 digital scanner supports signature capture, the quality of the image is not guaranteed. If the image does not meet your needs it is recommended that you upgrade to a DS8178 scanner.

---

## Code Structure

### Signature Capture Area

A CapCode is printed as two identical patterns on either side of a signature capture box, as shown in [Figure K-1](#). Each pattern extends the full height of the signature capture box.

The box is optional, so you can omit it, replace it with a single baseline, or print a baseline with an "X" on top of it towards the left, as is customarily done in the US to indicate a request for signature. However, if an "X" or other markings are added in the signature box area, these are captured with the signature.



Figure K-1 CapCode

## CapCode Pattern Structure

A CapCode pattern structure consists of a start pattern followed by a separator space, a signature capture box, a second separator space, and then a stop pattern. Assuming that  $X$  is the dimension of the thinnest element, the start and stop patterns each contains  $9X$  total width in 4 bars and 3 spaces. A  $7X$  quiet zone is required to the left and to the right of the CapCode pattern.

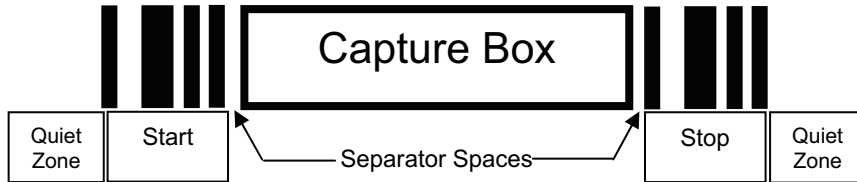

**Figure K-2** CapCode Structure

The separator spaces on either side of the signature capture box can be between  $1X$  and  $3X$  wide.

## Start / Stop Patterns

[Table K-1](#) lists the accepted start / stop patterns. The bar and space widths are expressed as multiples of  $X$ . You must use the same pattern on either side of a signature capture box. The type value is reported with the captured signature to indicate the purpose of the signature captured.

**Table K-1** Start / Stop Pattern Definitions

Bar/Space Patterns							Type
B	S	B	S	B	S	B	
1	1	2	2	1	1	1	2
1	2	2	1	1	1	1	5
2	1	1	2	1	1	1	7
2	2	1	1	1	1	1	8
3	1	1	1	1	1	1	9

[Table K-2](#) lists selectable parameters used to generate the image of the captured signature.

**Table K-2** *User Defined CapCode Parameters*

Parameter	Defined
Width	Number of pixels
Height	Number of pixels
Format	JPEG, BMP, TIFF
JPEG quality	1 (most compression) to 100 (best quality)
Bits Per Pixel (not applicable to JPEG format)	1 (2 levels)
	4 (16 levels)
	8 (256 levels)

BMP format does not use compression, JPEG and TIFF formats do.

---

## Dimensions

The size of the signature capture box is determined by the height and separation of the start and stop patterns. The line width of the signature capture box is insignificant.

The thinnest element width, referred to here as X, is nominally 10 mils (1 mil = 0.0254 mm). Select this as an exact multiple of the pixel pitch of the printer used. For example, when using a 203 DPI (dots-per-inch) printer and printing 2 dots per module, the resulting X dimension is 9.85 mils.

---

## Data Format

The decoder output is formatted according to [Table K-3](#). Zebra decoders allow different user options to output or inhibit bar code type. Selecting "Symbol ID" as the bar code type for output identifies the CapCode with letter "i".

**Table K-3** *Data Format*

File Format (1 byte)	Type (1 byte)	Image Size (4 bytes, BIG Endian)	Image Data
JPEG - 1 BMP - 3 TIFF - 4	See <a href="#">Table K-1</a> , last column		(Same bytes as in a data file)

---

## Additional Capabilities

Regardless of how the signature is captured, the output signature image is de-skewed and right-side up.

A scanner that captures signatures automatically determines whether it is scanning a signature or a bar code. You can disable the signature capturing capability in a decoder.

---

## Signature Boxes

*Figure K-3* illustrates the five acceptable signature boxes:

Type 2:



Type 5:



Type 7:



Type 8:



Type 9:



**Figure K-3** *Acceptable Signature Boxes*

# APPENDIX L NON-PARAMETER ATTRIBUTES

---

## Introduction

This appendix defines non-parameter attributes.

---

## Attributes

### Model Number

#### Attribute #533

Model number of the scanner. This electronic output matches the printout on the physical device label, for example **DS2278-SR00007ZZWW**.

Type	S
Size (Bytes)	18
User Mode Access	R
Values	Variable

### Serial Number

#### Attribute #534

Unique serial number assigned in the manufacturing facility. This electronic output matches the printout on the physical device label, for example **M1J26F45V**.

Type	S
Size (Bytes)	16
User Mode Access	R
Values	Variable



## Date of Manufacture

### Attribute #535

Date of device manufacture assigned in the manufacturing facility. This electronic output matches the printout on the physical device label, for example **30DEC16** (which reads the 30th of April 2014).

<b>Type</b>	S
<b>Size (Bytes)</b>	7
<b>User Mode Access</b>	R
<b>Values</b>	Variable

## Date of First Programming

### Attribute #614

Date of first electronic programming represents the first time settings were electronically loaded to the scanner either by 123Scan or via SMS, for example **30DEC16** (which reads the 30th of December 2016).

<b>Type</b>	S
<b>Size (Bytes)</b>	7
<b>User Mode Access</b>	R
<b>Values</b>	Variable

## Configuration Filename

### Attribute #616

The name assigned to the configuration settings loaded electronically to the device either by 123Scan or via SMS.



**NOTE** Scanning the **Set Defaults** bar code automatically changes the configuration filename to *factory defaults*.

To indicate the configuration settings loaded to the device were changed, the configuration filename changes to *Modified* upon scanning any parameter bar code.

<b>Type</b>	S
<b>Size (Bytes)</b>	17
<b>User Mode Access</b>	RW
<b>Values</b>	Variable

**Beeper/LED****Attribute #6000**

Activates the beeper and/or LED.

**Type** X  
**Size (Bytes)** N/A  
**User Mode Access** W

**Values:**

<b>Beep / LED Action</b>	<b>Value</b>
1 high short beep	0
2 high short beeps	1
3 high short beeps	2
4 high short beeps	3
5 high short beeps	4
1 low short beep	5
2 low short beeps	6
3 low short beeps	7
4 low short beeps	8
5 low short beeps	9
1 high long beep	10
2 high long beeps	11
3 high long beeps	12
4 high long beeps	13
5 high long beeps	14
1 low long beep	15
2 low long beeps	16
3 low long beeps	17
4 low long beeps	18
5 low long beeps	19
Fast warble beep	20
Slow warble beep	21
High-low beep	22
Low-high beep	23
High-low-high beep	24
Low-high-low beep	25
High-high-low-low beep	26
Green LED off	42
Green LED on	43
Red LED on	47
Red LED off	48

## Parameter Defaults

### Attribute #6001

This attribute restores all parameters to their factory defaults.

<b>Type</b>	X
<b>Size (Bytes)</b>	N/A
<b>User Mode Access</b>	W
<b>Values</b>	0 = Restore Defaults 1 = Restore Factory Defaults 2 = Write Custom Defaults

## Beep on Next Bootup

### Attribute #6003

This attribute configures (enables or disables) beep on next boot up of scanner.

<b>Type</b>	X
<b>Size (Bytes)</b>	N/A
<b>User Mode Access</b>	W
<b>Values</b>	0 = Disable beep on next bootup 1 = Enable beep on next bootup

## Reboot

### Attribute #6004

This attribute initiates a device reboot.

<b>Type</b>	X
<b>Size (Bytes)</b>	N/A
<b>User Mode Access</b>	W
<b>Values</b>	N/A

## Host Trigger Session

### Attribute #6005

This attribute triggers a decode session similar to manually depressing the scanner trigger button.

<b>Type</b>	X
<b>Size (Bytes)</b>	N/A
<b>User Mode Access</b>	W
<b>Values</b>	1 = Start Host Trigger Session 0 = Stop Host Trigger Session

## Firmware Version

### Attribute #20004

The scanner's operating system version. For example, **PAADES00-001-R00D0**.

<b>Type</b>	S
<b>Size (Bytes)</b>	Variable
<b>User Mode Access</b>	R
<b>Values</b>	Variable

## ImageKit Version

### Attribute #20008

Identifies the 1D decode algorithms resident on the device, for example **IMGKIT\_7.03T01**.

<b>Type</b>	S
<b>Size (Bytes)</b>	Variable
<b>User Mode Access</b>	R
<b>Values</b>	Variable

## In Cradle Detect

### Attribute #25000

<b>Type</b>	Byte
<b>Size (Bytes)</b>	1
<b>User Mode Access</b>	R
<b>Values</b>	0 - Out of cradle 1 - In cradle

## Charging

### Attribute #25002

<b>Type</b>	Byte
<b>Size (Bytes)</b>	1
<b>User Mode Access</b>	R
<b>Values</b>	0 - Not charging 1 - Charging

## Battery Charge State

### Attribute # 30042

Type	Flag
Size (Bytes)	1
User Mode Access	R
Values	0 - Not full 1 - Full

# Appendix M FIRMWARE UPGRADES USING iOS

---

## Introduction

This appendix provides information about performing firmware upgrades using iOS. The Zebra Scanner Control App for iOS provides an option to update firmware on your Bluetooth connected scanner. This application is available in iOS App stores and the Zebra AppGallery.

---

## Downloading Firmware Using the Zebra Scanner Control Application

To download firmware:

1. Install the Zebra Scanner Control application on your iOS device.
2. Create a folder on your Windows Desktop named **Download**.
3. Copy the scanner only plug-in (DS2278SR-SXXX-YY) into the **Download** folder as follows.
  - ✓ **NOTE** In the plug-in name DS2278SR-SXXX-YY, XXX refers to the plug-in revision and YY refers to the build number. The latest scanner only plug-in can be downloaded from 123Scan.
  - a. Load the 123Scan plug-in onto a Windows computer from: [www.Zebra.com/123Scan](http://www.Zebra.com/123Scan).
  - b. From your Windows PC with 123Scan, access the scanner's (scanner only) plug-in (.scnplg file) from C:\ProgramData\123Scan2\Plug-ins.
  - c. Copy the plug-in into the **Download** folder (created in [Step 2](#)).
4. Open iTunes and connect your iOS device to your computer via USB.
5. In iTunes, click the **iOS device** icon shown in [Figure M-1](#).

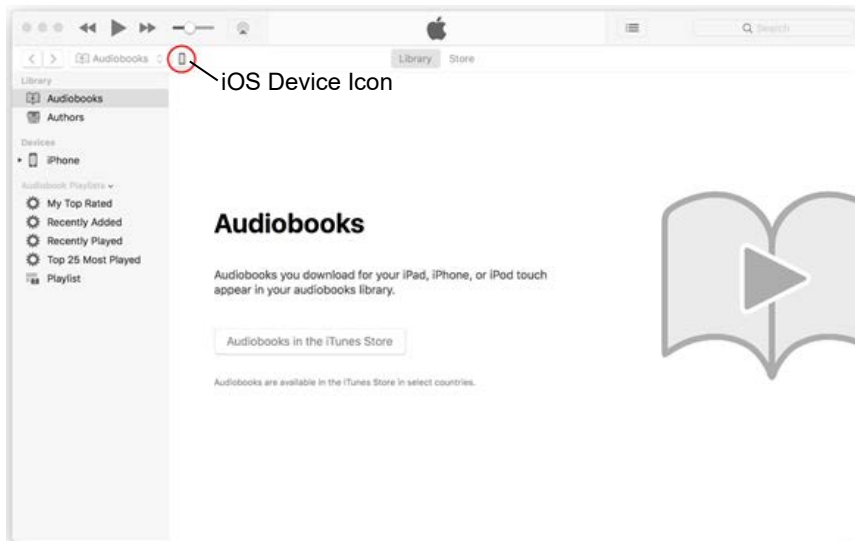

Figure M-1 iTunes - iOS Device Icon

6. Select **File Sharing** from the device menu (for your attached device).



Figure M-2 iTunes File Sharing Option

7. From the **Apps** list, click **Zebra Scanner**. Click the **Download** folder on the right and press **Delete** on the keyboard.

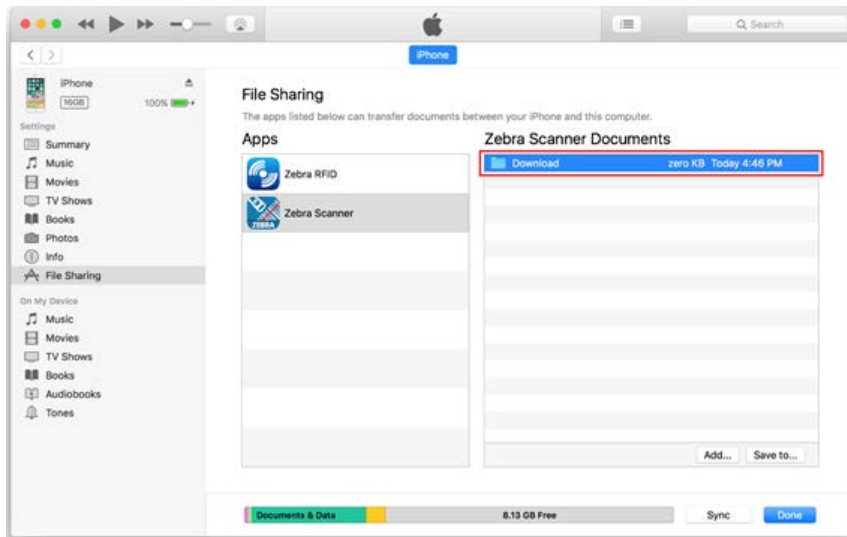

**Figure M-3** iTunes - Zebra Scanner Application/Zebra Scanner Documents

8. From the Windows Desktop, drag the **Download** folder into Zebra Scanner Documents.
9. Click **Sync**.
10. Open the Zebra Scanner Control application on the iOS device.
11. Connect the scanner to the iOS device and Zebra Scanner Control application.
12. Navigate to the **Settings** tab in the Zebra Scanner Control application, and tap **Update Firmware**.

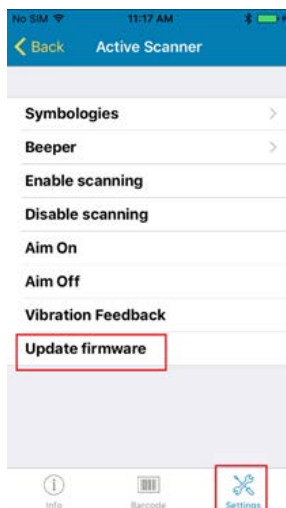

**Figure M-4** Settings - Update Firmware

13. Tap **UPDATE FIRMWARE** to start the process.



## M - 4 DS2278 Digital Scanner Product Reference Guide



**Figure M-5** *Update Firmware*

14. When the firmware update completes, the scanner automatically resets and installs the firmware.
15. The scanner sounds a beep and the LED illuminates green after the installation is complete.

# Appendix N UPGRADING OVER BLUETOOTH WITHOUT A CRADLE

---

## Introduction

This appendix provides information about performing upgrades on the scanner without a cradle, using 123Scan.

---

## Upgrading Without a Cradle

✓ **NOTE** To accomplish this your PC must support Bluetooth communication.

To upgrade a DS2278 scanner using 123Scan without a cradle:

1. From the 123Scan **Start** screen, select **Update Scanner Firmware**.
2. From the **No scanner was found!** dialog box, select **click here** to pair over Bluetooth.

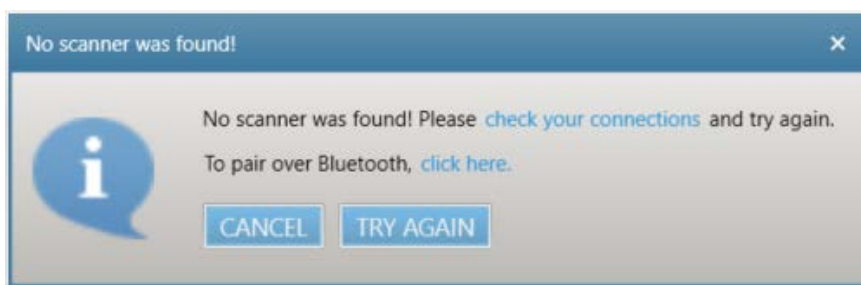

**Figure N-1** *Pair Over Bluetooth Dialog*

3. Scan the pairing bar code that displays to enable Bluetooth communication between the scanner and the host PC. Once paired (can take 15 seconds), 123Scan guides the user through the remaining steps.

✓ **NOTE** The pairing bar code in [Figure N-2](#) is a sample and not for scanning. Scan the actual pairing bar code that displays in 123Scan.



Figure N-2 Pairing Bar Code

## Troubleshooting

Problem	Possible Causes	Possible Solutions
The <b>Pair over Bluetooth</b> dialog box ( <a href="#">Figure N-1 on page N-1</a> ) does not display.	Scanner and/or cradle with a USB cable is connected to the PC.	Remove the USB cable connected to the PC from the scanner and/or cradle. Re-select <b>Update Scanner Firmware</b> from the 123Scan <b>Start</b> screen.
Pairing bar code does not work correctly.	Scanner was already paired directly to the PC using the Windows pairing process.	Select the <b>Bluetooth</b> icon in the PC tray and remove the scanner from the Bluetooth connection.
Windows displays the <b>Add a device</b> pop up window (see <a href="#">Figure N-3</a> ).	N/A	This is a Windows display message that cannot be suppressed.  Do not tap the <b>Add a device</b> window and continue to follow the 123Scan prompts to complete the process.

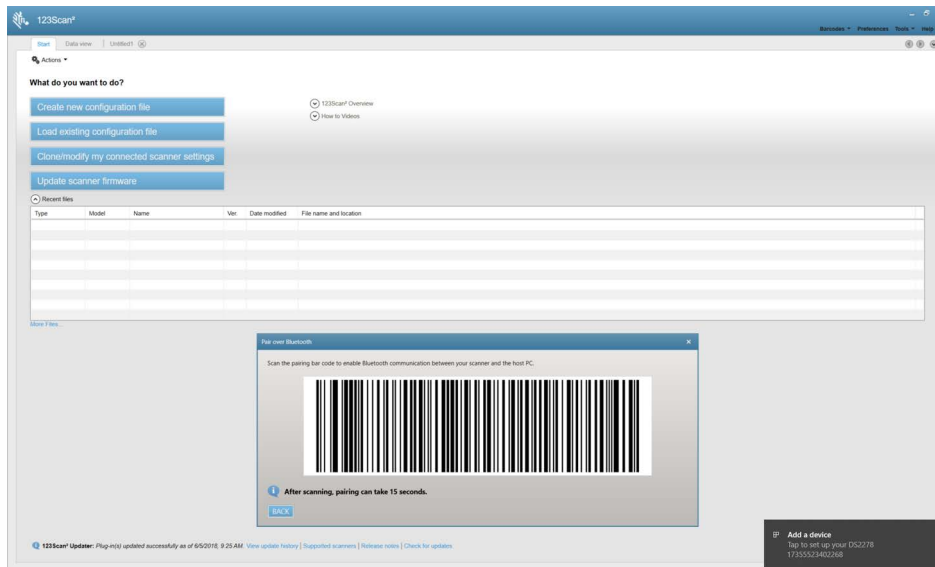

Figure N-3 Add a device Window



# INDEX

## Numerics

123Scan	
communication	2-2
LED indications	3-5
options	2-1
requirements	2-2
software tools	2-3
videos	2-2
2D bar codes	
aztec	13-93
aztec inverse	13-93
code 128 emulation	13-85
data matrix	13-86
data matrix inverse	13-87
data matrix mirror images	13-88
dotcode erasure limit	13-100
grid matrix	13-95
grid matrix inverse	13-95
grid matrix mirror	13-96
GS1 data matrix	13-86
GS1 QR	13-90
han xin	13-94
han xin inverse	13-94
linked QR	13-92
maxicode	13-89
microPDF417	13-84
microQR	13-90
PDF417	13-84
QR code	13-89

## A

accessories	1-10
interface cable	1-10
power supply	1-10
shielded cables	8-2

## ADF

invalid rule	4-5
transmit error	4-5
ADF programming indicators	3-3
advanced data formatting	4-5
aiming	
orientation	3-8
aiming options	
hand-held decode aiming pattern	5-19
aiming pattern	
enabling	5-19
ASCII values	
keyboard wedge	12-10
RS-232	10-18
attributes, non-parameter	
battery charge state	L-6
beep on next bootup	L-4
charging	L-5
configuration filename	L-2
date of first programming	L-2
date of manufacture	L-2
firmware version	L-5
host trigger session	L-4
imagekit version	L-5
in cradle detect	L-5
model number	L-1
parameter defaults	L-4
reboot	L-4
serial number	L-1
auto-reconnect	6-23, 6-27, 6-29
aztec bar codes	
sample	F-13

## B

bar code defaults	
radio communications	6-2

## Index - 2 DS2278 Digital Scanner Product Reference Guide

- bar codes
  - Australia post . . . . . 13-105
  - Australia post format . . . . . 13-106
  - auto-reconnect in Bluetooth keyboard emulation (HID peripheral) mode . . . . . 6-25
  - auto-reconnect interval . . . . . 6-23
  - aztec . . . . . 13-93
  - aztec inverse . . . . . 13-93
  - batch mode . . . . . 6-32, 6-34
  - battery preservation mode . . . . . 5-15
  - battery shut off . . . . . 1-7
  - beep after good decode . . . . . 5-6
  - beep on insertion . . . . . 6-26
  - beeper duration . . . . . 5-9
  - beeper tone . . . . . 5-8
  - beeper volume . . . . . 5-7
  - Bluetooth friendly name . . . . . 6-10
  - Bluetooth technology support . . . . . 6-16
  - bookland EAN . . . . . 13-11
  - bookland ISBN . . . . . 13-12
  - cancel . . . . . G-3, H-1
  - Chinese 2 of 5 . . . . . 13-66
  - codabar . . . . . 13-57
  - codabar CLSI editing . . . . . 13-59
  - codabar lengths . . . . . 13-57, 13-58
  - codabar NOTIS editing . . . . . 13-59
  - codabar start and stop characters . . . . . 13-60
  - code 11 . . . . . 13-44
  - code 11 check digit verification . . . . . 13-46
  - code 11 lengths . . . . . 13-44
  - code 128 . . . . . 13-27
  - code 128 emulation . . . . . 13-85
  - code 128 fnc4 . . . . . 13-32
  - code 128 lengths . . . . . 13-27
  - code 128 reduced quiet zone . . . . . 13-33
  - code 128 security level . . . . . 13-32, 13-33
  - code 32 prefix . . . . . 13-35
  - code 39 . . . . . 13-34
  - code 39 check digit verification . . . . . 13-37
  - code 39 full ASCII . . . . . 13-38
  - code 39 lengths . . . . . 13-36, 13-37
  - code 39 reduced quiet zone . . . . . 13-41
  - code 39 security level . . . . . 13-39, 13-40
  - code 39 transmit check digit . . . . . 13-38
  - code 93 . . . . . 13-41
  - code 93 lengths . . . . . 13-42
  - composite beep mode . . . . . 13-83
  - composite CC-A/B . . . . . 13-80
  - composite CC-C . . . . . 13-79
  - composite inverse . . . . . 13-81
  - composite TLC-39 . . . . . 13-80
  - continuous bar code read . . . . . 5-21
  - convert code 39 to code 32 . . . . . 13-35
  - convert GS1 databar to UPC/EAN/JAN . . . . . 13-72
  - convert UPC-E to UPC-A . . . . . 13-24
  - convert UPC-E1 to UPC-A . . . . . 13-24
  - country code page defaults . . . . . C-1
  - country code pages . . . . . C-5
  - country codes . . . . . B-2
  - data matrix . . . . . 13-86
  - data matrix inverse . . . . . 13-87
  - data matrix mirror images . . . . . 13-88
  - decode mirror images . . . . . 5-24
  - decode session timeout . . . . . 5-22
  - direct decode indicator . . . . . 5-10
  - disable all code types . . . . . 13-8
  - discrete 2 of 5 . . . . . 13-54
  - discrete 2 of 5 lengths . . . . . 13-55, 13-56
  - dotcode erasure limit . . . . . 13-100
  - EAN/JAN zero extend . . . . . 13-25
  - EAN-13 check digit . . . . . 13-20
  - EAN-13/JAN-13 . . . . . 13-11
  - EAN-8 check digit . . . . . 13-19
  - EAN-8/JAN-8 . . . . . 13-10
  - eclevel . . . . . 5-30
  - enable all code types . . . . . 13-8
  - enter . . . . . 5-31
  - escape characters . . . . . 13-101
  - event reporting
    - boot up event . . . . . 9-23
    - decode event . . . . . 9-22
    - parameter event . . . . . 9-23
  - febraban . . . . . 13-52
  - flush macro buffer/abort macro PDF entry . . . . . 13-101
  - FN1 substitution values . . . . . 5-36
  - grid matrix . . . . . 13-95
  - grid matrix inverse . . . . . 13-95
  - grid matrix mirror . . . . . 13-96
  - GS1 data matrix . . . . . 13-86
  - GS1 databar bar codes . . . . . 13-71
  - GS1 databar expanded . . . . . 13-72
  - GS1 databar limited . . . . . 13-71
  - GS1 databar limited margin check . . . . . 13-73
  - GS1 databar omnidirectional . . . . . 13-71
  - GS1 databar security level . . . . . 13-74
  - GS1 QR . . . . . 13-90
  - GS1-128 . . . . . 13-28
  - GS1-128 emulation mode . . . . . 13-83
  - han xin . . . . . 13-94
  - han xin inverse . . . . . 13-94
  - hand-held decode aiming pattern . . . . . 5-18, 5-19
  - hands-free mode . . . . . 5-17
  - HID device conversion . . . . . 1-6
  - I 2 of 5 check digit verification . . . . . 13-50
  - I 2 of 5 convert to EAN-13 . . . . . 13-51
  - I 2 of 5 reduced quiet zone . . . . . 13-54
  - I 2 of 5 security level . . . . . 13-53
  - I 2 of 5 transmit check digit . . . . . 13-51

- IBM
  - bar code configuration directive . . . . . 11-6
  - beep directive . . . . . 11-5
  - convert unknown to code 39 . . . . . 11-5
  - default table . . . . . 11-3
  - IBM specification version . . . . . 11-6
  - port address . . . . . 11-4
- illumination . . . . . 5-26
- illumination brightness . . . . . 5-26
- intercharacter gap size . . . . . 13-79
- interleaved 2 of 5 . . . . . 13-47
  - convert to EAN-13 . . . . . 13-51, 13-52, 13-53
- interleaved 2 of 5 lengths . . . . . 13-48, 13-49
- inverse 1D . . . . . 13-70
- ISBT 128 . . . . . 13-29
- ISBT concatenation . . . . . 13-30, 13-31
- ISBT concatenation redundancy . . . . . 13-31
- ISSN EAN . . . . . 13-12
- Japan postal . . . . . 13-104
- keyboard wedge
  - alternate numeric keypad emulation . . . . . 12-6
  - caps lock override . . . . . 12-7
  - convert case . . . . . 12-8
  - default table . . . . . 12-3
  - host types . . . . . 12-4
  - intra-keystroke delay . . . . . 12-5
  - keystroke delay . . . . . 12-5
  - quick keypad emulation . . . . . 12-6
  - simulated caps lock . . . . . 12-7
  - unknown characters . . . . . 12-4
- Korean 3 of 5 . . . . . 13-69
- LED on good decode . . . . . 5-10
- linked QR . . . . . 13-92
- lock override . . . . . 6-27
- low light enhancement . . . . . 5-28
- low light scene detection . . . . . 5-27
- low power mode . . . . . 5-11
- mailmark . . . . . 13-108
- manufacturing information . . . . . 5-39
- matrix 2 of 5 . . . . . 13-66
- matrix 2 of 5 check digit . . . . . 13-68
- matrix 2 of 5 lengths . . . . . 13-67, 13-68
- maxicode . . . . . 13-89
- microPDF417 . . . . . 13-84
- microQR . . . . . 13-90
- mobile phone/display mode . . . . . 5-24
- motion tolerance . . . . . 5-28
- MSI . . . . . 13-61
  - MSI check digit algorithm . . . . . 13-65
  - MSI check digits . . . . . 13-64
  - MSI lengths . . . . . 13-62
  - MSI reduced quiet zone . . . . . 13-65
  - MSI transmit check digit . . . . . 13-64
- Netherlands KIX code . . . . . 13-107
- numeric bar codes . . . . . G-3, H-1
- parameter scanning . . . . . 5-6
- PDF prioritization . . . . . 5-25
- PDF prioritization timeout . . . . . 5-25
- PDF417 . . . . . 13-84
- picklist mode . . . . . 5-20
- pid type . . . . . 5-29
- pid value . . . . . 5-29
- postal . . . . . 13-102
- prefix/suffix values . . . . . 5-33
- QR code . . . . . 13-89
- quiet zone level . . . . . 13-78
- radio
  - Apple iOS virtual keyboard toggle . . . . . 6-16
  - auto-reconnect . . . . . 6-23
  - batch mode . . . . . 6-32
  - beep on . . . . . 6-26
  - beep on insertion . . . . . 6-26
  - bluetooth friendly name . . . . . 6-10
  - bluetooth radio state . . . . . 6-16
  - bluetooth security . . . . . 6-35
  - connection maintenance interval . . . . . 6-29
  - convert case . . . . . 6-22
  - cradle bluetooth . . . . . 6-5
  - discoverable mode . . . . . 6-11
  - emulate keypad . . . . . 6-19
  - fast HID keyboard . . . . . 6-20
  - HID bluetooth . . . . . 6-6
  - HID caps lock override . . . . . 6-18
  - HID function key mapping . . . . . 6-21
  - HID ignore unknown characters . . . . . 6-19
  - HID keyboard FN1 sub . . . . . 6-21
  - HID keyboard keystroke delay . . . . . 6-18
  - link supervision timeout . . . . . 6-15
  - lock override . . . . . 6-27
  - output power . . . . . 6-14
  - pairing methods . . . . . 6-28
  - persistent batch storage . . . . . 6-34
  - quick keypad emulation . . . . . 6-20
  - SSI . . . . . 6-7
  - SSP . . . . . 6-9
  - toggle pairing . . . . . 6-29
  - unpairing . . . . . 6-29
  - wi-fi friendly channel exclusion . . . . . 6-12
  - wi-fi friendly mode . . . . . 6-12
- reconnect attempt beep . . . . . 6-23
- reconnect attempt interval . . . . . 6-24
- redundancy level . . . . . 13-75
- RS-232
  - baud rate . . . . . 10-8
  - beep on bel . . . . . 10-16
  - check receive errors . . . . . 10-10
  - data bits . . . . . 10-10
  - default table . . . . . 10-3



## Index - 4 DS2278 Digital Scanner Product Reference Guide

- hardware handshaking . . . . . 10-11, 10-12
- host serial response timeout . . . . . 10-15
- host types . . . . . 10-6
- intercharacter delay . . . . . 10-17
- nixdorf beep LED options . . . . . 10-18
- parity . . . . . 10-9
- RTS line state . . . . . 10-16
- software handshaking . . . . . 10-13, 10-14
- stop bits . . . . . 10-9
- unknown characters . . . . . 10-18
- samples . . . . . F-1
- scan data options . . . . . 5-34
- security level . . . . . 13-77
- send versions . . . . . 5-39
- serial number . . . . . 5-39
- set defaults . . . . . 5-5
- signature capture . . . . . 7-3
  - default table . . . . . 7-2
- signature capture bits per pixel . . . . . 7-5
- signature capture file format . . . . . 7-4
- signature capture height . . . . . 7-6
- signature capture JPEG quality . . . . . 7-6
- signature capture width . . . . . 7-6
- software version . . . . . 5-39
- SSI
  - baud rate . . . . . 9-12
  - check parity . . . . . 9-15
  - data packet format . . . . . 9-17
  - host character time-out . . . . . 9-19
  - host RTS line state . . . . . 9-17
  - host serial response timeout . . . . . 9-18
  - interpacket delay . . . . . 9-21
  - multipacket option . . . . . 9-20
  - parity . . . . . 9-14
  - selecting . . . . . 9-12
  - software handshaking . . . . . 9-16
  - stop bit select . . . . . 9-15
- suppress power up beeps . . . . . 5-9
- symbolologies
  - default table . . . . . 13-2
- tab key . . . . . 5-31
- time delay to low power mode . . . . . 5-12
- timeout between decodes, different symbols . . . . . 5-23
- timeout between decodes, same symbol . . . . . 5-23
- transmit code 11 check digits . . . . . 13-47
- transmit code ID character . . . . . 5-32
- transmit matrix 2 of 5 check digit . . . . . 13-69
- transmit no read message . . . . . 5-37
- transmit UK postal check digit . . . . . 13-104
- transmit US postal check digit . . . . . 13-103
- trigger mode . . . . . 5-16
- trigger modes . . . . . 5-14
- trioptic code 39 . . . . . 13-34
- UCC coupon extended code . . . . . 13-25
- UK postal . . . . . 13-103
- unicode output control . . . . . D-1
- unique bar code reporting . . . . . 5-21
- unpair . . . . . 6-28, 6-29
- unsolicited heartbeat interval . . . . . 5-38
- UPC composite mode . . . . . 13-82
- UPC reduced quiet zone . . . . . 13-26
- UPC/EAN/JAN supplemental AIM ID format . . . . . 13-17
- UPC/EAN/JAN supplemental redundancy . . . . . 13-16
- UPC/EAN/JAN supplementals . . . . . 13-13
- UPC-A . . . . . 13-9
  - UPC-A check digit . . . . . 13-18
  - UPC-A preamble . . . . . 13-21
- UPC-E . . . . . 13-9
  - UPC-E check digit . . . . . 13-18
  - UPC-E preamble . . . . . 13-22
- UPC-E1 . . . . . 13-10
  - UPC-E1 check digit . . . . . 13-19
  - UPC-E1 preamble . . . . . 13-23
- UPU FICS postal . . . . . 13-108
- US planet . . . . . 13-102
- US postnet . . . . . 13-102
- USB
  - bar code configuration directive . . . . . 8-20
  - beep directive . . . . . 8-20
  - caps lock override . . . . . 8-8
  - CDC beep on bel . . . . . 8-17
  - CDC host variant . . . . . 8-17
  - convert case . . . . . 8-16
  - convert unknown to code 39 . . . . . 8-9
  - country keyboard types (country codes) . . . . . B-2
  - default table . . . . . 8-3
  - device type . . . . . 8-5
  - direct I/O beep . . . . . 8-19
  - fast HID . . . . . 8-10
  - function key mapping . . . . . 8-15
  - IBM specification version . . . . . 8-21
  - keyboard FN1 substitution . . . . . 8-14
  - keypad emulation . . . . . 8-13
  - keypad emulation with leading zero . . . . . 8-14
  - keystroke delay . . . . . 8-8
  - native firmware update . . . . . 8-7
  - polling interval . . . . . 8-11
  - quick emulation . . . . . 8-13
  - simulated caps lock . . . . . 8-15
  - SNAPI handshaking . . . . . 8-7
  - static CDC . . . . . 8-16
  - unknown characters . . . . . 8-9
- user preferences
  - default table . . . . . 5-2
- USPS 4CB/One Code/Intelligent Mail . . . . . 13-107
- virtual tether . . . . . 6-40
- weblink QR . . . . . 13-91
- wi-fi friendly channel exclusion . . . . . 6-12

- wi-fi friendly mode . . . . . 6-12
- batch mode stored data . . . . . 6-32
- battery
  - charging notes . . . . . 1-5
  - charging with cradle . . . . . 1-5
  - charging with micro USB . . . . . 1-6
  - indicators . . . . . 3-2
  - preservation mode . . . . . 5-15
  - shut off . . . . . 1-7
- beeper definitions
  - pairing . . . . . 6-5
  - wireless . . . . . 6-5
- beeper indicators
  - ADF programming . . . . . 3-3
  - battery . . . . . 3-2
  - host specific . . . . . 3-4
  - macro pdf . . . . . 3-3
  - parameter programming . . . . . 3-3
  - radio . . . . . 3-2
  - scanning . . . . . 3-1
  - standard . . . . . 3-1
  - wireless . . . . . 3-2
- Bluetooth
  - encryption . . . . . 6-35
  - HID . . . . . 6-9, 6-16, 6-25
  - pairing . . . . . 6-31
  - profiles . . . . . 6-5
  - secure simple pairing IO capability . . . . . 6-35
  - serial port profile . . . . . 6-9
  - set friendly name . . . . . 6-10
  - SPP . . . . . 6-31
- bluetooth . . . . . 1-3, 1-10
- bullets . . . . . xxii

## C

- cable configurations . . . . . xx
- cables . . . . . xx
  - installing . . . . . 1-4
  - interface . . . . . 1-10
  - shielded . . . . . 8-2
  - signal descriptions . . . . . 4-11
- CDC host variant . . . . . 8-17
- central . . . . . 6-10
- central serial port profile . . . . . 6-27
- character sets
  - keyboard wedge . . . . . 12-10
  - RS-232 . . . . . 10-18
- charging battery
  - cradle . . . . . 1-5
  - micro USB . . . . . 1-6
  - notes . . . . . 1-5
- Chinese 2 of 5 bar codes . . . . . 13-66
  - sample . . . . . F-7
- CJK . . . . . D-1
- cleaning the device
  - approved for standard devices . . . . . 4-2
- cleaning the devices
  - how to . . . . . 4-2
  - known harmful ingredients . . . . . 4-1
- codabar bar codes . . . . . 13-57
  - CLSI editing . . . . . 13-59
  - lengths . . . . . 13-57, 13-58
  - NOTIS editing . . . . . 13-59
  - start and stop characters . . . . . 13-60
- code 11 bar codes . . . . . 13-44
  - check digit verification . . . . . 13-46
  - lengths . . . . . 13-44
  - sample . . . . . F-6
  - transmit check digit . . . . . 13-47
- code 128 bar codes . . . . . 13-27
  - fnc4 . . . . . 13-32
  - GS1-128 . . . . . 13-28
  - ISBT 128 . . . . . 13-29
  - ISBT concatenation . . . . . 13-30, 13-31
  - ISBT concatenation redundancy . . . . . 13-31
  - lengths . . . . . 13-27
  - reduced quiet zone . . . . . 13-33
  - sample . . . . . F-5
  - security level . . . . . 13-32, 13-33
- code 128 emulation bar codes . . . . . 13-85
- code 39 bar codes . . . . . 13-34
  - check digit verification . . . . . 13-37
  - code 32 prefix . . . . . 13-35
  - code 39 . . . . . 13-34
  - code 39 security Level . . . . . 13-39, 13-40
  - convert code 39 to code 32 . . . . . 13-35
  - full ASCII . . . . . 13-38
  - lengths . . . . . 13-36, 13-37
  - reduced quiet zone . . . . . 13-41
  - sample . . . . . F-1, F-5
  - transmit check digit . . . . . 13-38
  - trioptic . . . . . 13-34
- code 93 bar codes . . . . . 13-41
  - lengths . . . . . 13-42
  - sample . . . . . F-6
- code ID character . . . . . 5-32
- code identifiers
  - AIM code IDs . . . . . E-3
  - modifier characters . . . . . E-4
  - Symbol . . . . . E-1
- communication protocol
  - cable interface . . . . . J-1
- composite bar codes
  - beep mode . . . . . 13-83
  - composite CC-A/B . . . . . 13-80
  - composite CC-C . . . . . 13-79
  - composite inverse . . . . . 13-81

## Index - 6 DS2278 Digital Scanner Product Reference Guide

composite TLC-39 .....	13-80
GS1-128 emulation mode .....	13-83
UPC composite mode .....	13-82
configurations .....	.xix
cables .....	.xx
product line .....	.xx
configuring scanner .....	1-10
connecting	
IBM host .....	11-2
keyboard wedge interface .....	12-2
lost connection .....	1-10
RS-232 interface .....	10-2
USB interface .....	8-2
conventions	
notational .....	.xxi
country code page defaults .....	C-1
country code pages .....	C-5
country codes .....	B-2
cradle	
connecting .....	1-4
inserting scanner .....	1-9
presentation	
features .....	1-4
supply power .....	1-5
cradle indicators	
charging .....	3-5
maintenance .....	3-5
standard use .....	3-5
cradle indicators (host controlled) .....	3-5
<b>D</b>	
data matrix bar codes .....	13-86
sample .....	F-11, F-13
decode zones	
ranges .....	3-8
default parameters .....	5-2
IBM .....	11-3
keyboard wedge .....	12-3
radio communications .....	6-2
RS-232 .....	10-3
setting .....	5-5
signature capture .....	7-2
SSI .....	9-11
symbologies .....	13-2
USB .....	8-3
user preferences .....	5-2
digital scanner	
features .....	1-3
discrete 2 of 5 bar codes .....	13-54
lengths .....	13-55, 13-56

## E

ecllevel .....	5-30
encryption .....	6-35
error indications	
ADF .....	4-5
format .....	4-6
input .....	4-5
miscellaneous scanner options .....	6-2
exposure options	
illumination .....	5-26
low light enhancement .....	5-28

## F

features .....	1-3
firmware	
flash update .....	5-29, 5-30
LED indications .....	3-4
updates	
LED indications .....	3-5
scanner control app .....	M-1
version .....	L-5

## G

grid matrix bar codes	
sample .....	F-13
gs1 data matrix bar codes	
sample .....	F-11
GS1 databar .....	13-71
GS1 databar bar codes	
convert GS1 databar to UPC/EAN/JAN .....	13-72
GS1 databar expanded .....	13-72
GS1 databar limited .....	13-71
GS1 databar limited margin check .....	13-73
GS1 databar omnidirectional .....	13-71
GS1 databar security level .....	13-74
sample .....	F-8
GS1 QR bar codes	
sample .....	F-12

## H

han xin bar codes	
sample .....	F-14
HID Profile .....	6-9
host specific indicators .....	3-4
host types	
keyboard wedge .....	12-4
RS-232 .....	10-6

**I**

IBM	
connection	11-2
default parameters	11-3
parameters	11-4
illumination	5-26
brightness	5-26
low light scene detection	5-27
image options	
signature capture	7-3
interleaved 2 of 5 bar codes	13-47
check digit verification	13-50
convert to EAN-13	13-51
febraban	13-52
lengths	13-48, 13-49
reduced quiet zone	13-54
sample	F-6
security level	13-53
transmit check digit	13-51

**K**

## keyboard types (country codes)

Albanian	B-2
Arabic (101)	B-2
Arabic (102)	B-3
Arabic (102) Azerty	B-3
Azeri (Cyrillic)	B-3
Azeri (Latin)	B-3
Belarusian	B-3
Bosnian (Cyrillic)	B-3
Bosnian (Latin)	B-3, B-4
Bulgarian (Latin)	B-4
Bulgarian Cyrillic (Typewriter)	B-4
Canadian French (Legacy)	B-4
Canadian French Win7	B-4
Canadian Multilingual Standard	B-4
Chinese (ASCII)	B-4
Croatian	B-5
Czech	B-5
Czech (Programmer)	B-5
Czech (QWERTY)	B-5
Danish	B-5
Dutch (Netherlands)	B-6
Estonian	B-6
Faeroese	B-6
Finnish	B-6
French (Canada) 2000/XP	B-7
French (Canada) 95/98	B-6
French (France)	B-6
French International	B-6
Galician	B-7
German	B-7

Greek	B-7
Greek (220) Latin	B-7
Greek (319) Latin	B-7
Greek 220	B-8
Greek 319	B-8
Greek Latin	B-7
Greek Polytonic	B-8
Hebrew Israel	B-8
Hungarian	B-8
Hungarian_101KEY	B-8
Irish	B-9
Islandic	B-8
Italian	B-9
Italian (142)	B-9
Japanese (ASCII)	B-9
Kazakh	B-9
Korean (ASCII)	B-9, B-10
Kyrgyz	B-10
Latin American	B-10
Latvian	B-10
Latvian (QWERTY)	B-10
Lithuanian	B-10
Lithuanian (IBM)	B-10
Macedonian (FYROM)	B-11
Maltese_47KEY	B-11
Mongolian	B-11
Norwegian	B-11
Polish (214)	B-11
Polish (Programmer)	B-11
Portuguese (Brazil)	B-11
Portuguese (Brazilian ABNT)	B-12
Portuguese (Brazilian ABNT2)	B-12
Portuguese (Portugal)	B-12
Romanian	B-12
Romanian (Legacy)	B-12
Romanian (Programmer)	B-13
Romanian (Standard)	B-12
Russian	B-13
Russian (Typewriter)	B-13
Serbian (Cyrillic)	B-13
Serbian (Latin)	B-13
Slovak	B-13
Slovak (QWERTY)	B-14
Slovenian	B-14
Spanish	B-14
Spanish (Variation)	B-14
Swedish	B-14
Swiss French	B-14
Swiss German	B-14
Tatar	B-15
Thai (Kedmanee)	B-15
Turkish F	B-15
Turkish Q	B-15
UK English	B-15

## Index - 8 DS2278 Digital Scanner Product Reference Guide

Ukrainian	B-15
US Dvorak	B-15
US Dvorak Left	B-16
US Dvorak Right	B-16
US English	B-2
US International	B-16
Uzbek	B-16
Vietnamese	B-16
keyboard wedge	
connection	12-2
default parameters	12-3
parameters	12-4
Korean 2 of 5 bar codes	
sample	F-8
Korean 3 of 5 bar codes	13-69

## L

LED indicators	
ADF programming	3-3
battery	3-2
cradle	3-5
cradle, host controlled	3-5
host specific	3-4
macro pdf	3-3
parameter programming	3-3
radio	3-2
scanning	3-1
standard	3-1
wireless	3-2
lock override	6-27
locked pairing mode	6-29
locked pairing mode bar codes	
radio pairing modes	6-27
low light enhancement	5-28
low power mode	6-23

## M

macro PDF	
escape characters	13-101
flush buffer/abort PDF entry	13-101
macro pdf indicators	3-3
maintenance	4-1
approved cleaners	4-2
how to clean the devices	4-2
known harmful ingredients	4-1
matrix 2 of 5 bar codes	13-66
check digit	13-68
lengths	13-67, 13-68
sample	F-7
transmit check digit	13-69
maxicode bar codes	13-89
sample	F-12

micro USB cable	
charging battery	1-6
convert CDC device to HID	1-6
HID device conversion	1-6
microPDF417 bar codes	13-84
microQR code bar codes	
sample	F-13
MSI bar codes	13-61
check digit algorithm	13-65
check digits	13-64
lengths	13-62
reduced quiet zone	13-65
transmit check digit	13-64
msi bar codes	
sample	F-7

## N

non-parameter attributes	
battery charge state	L-6
beep on next bootup	L-4
charging	L-5
configuration filename	L-2
date of first programming	L-2
date of manufacture	L-2
firmware version	L-5
host trigger session	L-4
imagekit version	L-5
in cradle detect	L-5
model number	L-1
parameter defaults	L-4
reboot	L-4
serial number	L-1
notational conventions	xxi

## O

out of range indicator	6-25
------------------------	------

## P

pairing	1-9
address	6-23
bar code	6-5
bar code format	6-31
central/peripheral setup	6-10
lock override	6-27
methods	6-28
modes	6-3, 6-27, A-4
on contacts	6-3, A-4
radio communication	1-10
reconnecting	6-28
unpair	6-28, 6-29
using scan-to-connect	2-4, 6-31

- pairing beeper definitions . . . . . 6-5
- parameter defaults
  - radio communications . . . . . 6-2
- parameter programming indicators . . . . . 3-3
- parameters
  - batch mode . . . . . 6-32, 6-34
  - beep on insertion . . . . . 6-26
  - Bluetooth technology support . . . . . 6-16
  - persistent batch storage . . . . . 6-34
  - radio communication . . . . . 6-5
    - auto-reconnect interval . . . . . 6-23
    - batch mode . . . . . 6-32, 6-34
    - connection maintenance interval . . . . . 6-29
    - host types . . . . . 6-5
    - pairing . . . . . 6-27
    - persistent batch storage . . . . . 6-34
  - reconnect attempt beep . . . . . 6-23
  - reconnect attempt interval . . . . . 6-24
  - unpair . . . . . 6-28, 6-29
- parts
  - scanner . . . . . 1-4
- PDF417 bar codes . . . . . 13-84
  - PDF prioritization . . . . . 5-25
  - sample . . . . . F-11
- peripheral . . . . . 6-10
- pinouts
  - cradle signal descriptions . . . . . 4-11
- postal code bar codes
  - sample . . . . . F-14
- postal codes . . . . . 13-102
  - Australia post . . . . . 13-105
  - Australia post format . . . . . 13-106
  - Japan postal . . . . . 13-104
  - mailmark . . . . . 13-108
  - Netherlands KIX code . . . . . 13-107
  - transmit UK postal check digit . . . . . 13-104
  - transmit US postal check digit . . . . . 13-103
  - UK postal . . . . . 13-103
  - UPU FICS postal . . . . . 13-108
  - US planet . . . . . 13-102
  - US postnet . . . . . 13-102
  - USPS 4CB/One Code/Intelligent Mail . . . . . 13-107
- power . . . . . 1-5
- power supply . . . . . 1-10
- product id (pid) value . . . . . 5-29
- product id type . . . . . 5-29
- product line configurations . . . . . xx

## Q

- QR code bar codes . . . . . 13-89, 13-90, 13-91
  - sample . . . . . F-12, F-13
- quick start guide . . . . . 1-10

## R

- radio communication
  - bluetooth . . . . . 1-3
  - bluetooth technology profile support . . . . . 1-10
  - pairing . . . . . 1-10
  - parameters . . . . . 6-5
  - reconnect attempt . . . . . 6-24
  - reconnect attempt beep . . . . . 6-23
- radio communications
  - defaults . . . . . 6-2
- radio indicators . . . . . 3-2
- range indicator . . . . . 6-25
- reconnect attempt . . . . . 6-24
- reconnect attempt beep . . . . . 6-23
- reconnect pairing . . . . . 6-28
- RS-232
  - connection . . . . . 10-2
  - default parameters . . . . . 10-3
  - parameters . . . . . 10-4, 10-6
- RSM
  - commands and responses over SSI . . . . . 9-8

## S

- sample bar codes
  - aztec . . . . . F-13
  - Chinese 2 of 5 . . . . . F-7
  - code 11 . . . . . F-6
  - code 128 . . . . . F-5
  - code 39 . . . . . F-1, F-5
  - code 93 . . . . . F-6
  - data matrix . . . . . F-11, F-13
  - grid matrix . . . . . F-13
  - gs1 data matrix . . . . . F-11
  - GS1 databar . . . . . F-8
  - GS1 QR . . . . . F-12
  - han xin . . . . . F-14
  - interleaved 2 of 5 . . . . . F-6
  - Korean 2 of 5 . . . . . F-8
  - matrix 2 of 5 . . . . . F-7
  - maxicode . . . . . F-12
  - microQR code . . . . . F-13
  - msi . . . . . F-7
  - PDF417 . . . . . F-11
  - QR code . . . . . F-12, F-13
  - UK postal . . . . . F-14
  - UPC/EAN . . . . . F-1
  - US postnet . . . . . F-14
- scanner control app . . . . . 2-3, 2-4, M-1
- scanner parts . . . . . 1-4
- scanner to cradle support . . . . . 6-27
- scanner(s) to cradle support . . . . . 6-27
- scanning

## Index - 10DS2278 Digital Scanner Product Reference Guide

- aiming ..... 3-8
  - errors ..... 5-2, 8-1, 9-10, 10-2, 11-2, 12-1, 13-2
  - hand-held mode ..... 3-6
  - presentation mode ..... 3-6
  - radio communications sequence example ..... 6-2
  - sequence example ..... 5-2, 8-1, 9-10, 10-2, 11-1, 12-1, 13-2
  - setting parameters ..... 5-1, 6-1, 8-1, 9-10, 10-1, 11-1, 12-1, ..... 13-1
  - scanning indicators ..... 3-1
  - scan-to-connect utility ..... 2-4, 6-31
  - secure simple pairing IO capability ..... 6-35
  - security
    - intercharacter gap size ..... 13-79
    - quiet zone level ..... 13-78
    - redundancy level ..... 13-75
    - security level ..... 13-77
  - Serial Port Profile
    - central ..... 6-27
    - support ..... 6-9
  - service information ..... xxii
  - setting defaults ..... 5-5
  - setup
    - connecting a USB interface ..... 8-2
    - connecting an IBM most ..... 11-2
    - connecting an RS-232 interface ..... 10-2
    - connecting keyboard wedge interface ..... 12-2
    - inserting scanner in cradle ..... 1-9
    - lost host connection ..... 1-10
    - supplying power ..... 1-5
    - unpacking ..... 1-2
  - shut off battery ..... 1-7
  - signal descriptions ..... 4-11
  - signature capture ..... 7-3
    - bits per pixel ..... 7-5
    - default parameters ..... 7-2
    - file format selector ..... 7-4
    - height ..... 7-6
    - JPEG quality ..... 7-6
    - width ..... 7-6
  - signature capture options
    - signature capture file format ..... 7-4
  - simple serial interface
    - baud rate ..... 9-12
    - commands ..... 9-2
    - communications ..... 9-1, 9-6
    - default parameters ..... 9-11
    - handshaking ..... 9-3, 9-6
    - RSM commands and responses ..... 9-8
    - RTS CTS ..... 9-6
    - selecting ..... 9-12
    - transactions ..... 9-3
  - software tools ..... 2-3
    - scanner control app ..... 2-4
    - scan-to-connect utility ..... 2-4, 6-31
  - specifications ..... 4-8
  - SPP
    - central ..... 6-27
    - support ..... 6-9
  - SSI
    - baud rate ..... 9-12
    - commands ..... 9-2
    - communications ..... 9-1, 9-6
    - default parameters ..... 9-11
    - handshaking ..... 9-3, 9-6
    - RSM commands and responses ..... 9-8
    - RTS CTS ..... 9-6
    - selecting ..... 9-12
    - transactions ..... 9-3
  - STC ..... 2-4, 6-31
  - stored data
    - batch mode ..... 6-32
  - support ..... xxii
  - symbology default parameters ..... 13-2
- ## T
- technical specifications ..... 4-8
  - trigger mode ..... 5-16
  - troubleshooting ..... 4-3
- ## U
- unicode
    - output control ..... D-1
  - unlocked pairing mode ..... 6-27
  - unpacking ..... 1-2
  - unpairing
    - bar code ..... 6-28, 6-29
  - UPC/EAN/JAN bar codes
    - bookland EAN ..... 13-11
    - bookland ISBN ..... 13-12
    - check digit ..... 13-18, 13-19, 13-20
    - convert UPC-E to UPC-A ..... 13-24
    - convert UPC-E1 to UPC-A ..... 13-24
    - EAN/JAN zero extend ..... 13-25
    - EAN-13/JAN-13 ..... 13-11
    - EAN-8/JAN-8 ..... 13-10
    - ISSN EAN ..... 13-12
    - reduced quiet zone ..... 13-26
  - samples ..... F-1
  - supplemental AIM ID format ..... 13-17
  - supplemental redundancy ..... 13-16
  - supplementals ..... 13-13
  - UCC coupon extended code ..... 13-25
  - UPC-A ..... 13-9
  - UPC-A preamble ..... 13-21
  - UPC-E ..... 13-9

- UPC-E preamble . . . . . 13-22
- UPC-E1 . . . . . 13-10
- UPC-E1 preamble . . . . . 13-23
- USB
  - connection . . . . . 8-2
  - default parameters . . . . . 8-3
  - parameters . . . . . 8-5
- user preferences bar codes
  - batch mode . . . . . 6-32, 6-34
  - beep on insertion . . . . . 6-26
  - persistent batch storage . . . . . 6-34
  
- V**
  - version
    - bar codes . . . . . 5-39
  - virtual tether . . . . . 6-40
  
- W**
  - wi-fi friendly mode
    - channel exclusion . . . . . 6-12
    - notes . . . . . 6-12
  - wireless indicators . . . . . 3-2
  
- Z**
  - Zebra support . . . . . xxii







Zebra Technologies Corporation, Inc.  
3 Overlook Point  
Lincolnshire, IL 60069, U.S.A.  
[www.zebra.com](http://www.zebra.com)

ZEBRA and the stylized Zebra head are trademarks of Zebra Technologies Corporation, registered in many jurisdictions worldwide. All other trademarks are the property of their respective owners. ©2024 Zebra Technologies Corporation and/or its affiliates. All rights reserved.