

# MICROSCAN

## MS-9 Scanner User Manual



---

Copyright ©2015  
Microscan Systems, Inc.  
Tel: +1.425.226.5700 / 800.762.1149  
Fax: +1.425.226.8250

All rights reserved. The information contained herein is proprietary and is provided solely for the purpose of allowing customers to operate and/or service Microscan manufactured equipment and is not to be released, reproduced, or used for any other purpose without written permission of Microscan.

Throughout this manual, trademarked names might be used. We state herein that we are using the names to the benefit of the trademark owner, with no intention of infringement.

## ***Disclaimer***

The information and specifications described in this manual are subject to change without notice.

## ***Latest Manual Version***

For the latest version of this manual, see the Download Center on our web site at:  
[www.microscan.com](http://www.microscan.com).

## ***Technical Support***

For technical support, e-mail: [helpdesk@microscan.com](mailto:helpdesk@microscan.com).

## ***Warranty***

For current warranty information, see: [www.microscan.com/warranty](http://www.microscan.com/warranty).

## **Microscan Systems, Inc.**

### **United States Corporate Headquarters**

+1.425.226.5700 / 800.762.1149

### **United States Northeast Technology Center**

+1.603.598.8400 / 800.468.9503

### **European Headquarters**

+31.172.423360

### **Asia Pacific Headquarters**

+65.6846.1214

# Table of Contents

<b>Chapter 1</b>	<b>Quick Start</b>	
	Step 1 Hardware Required .....	1-2
	Step 2 Connect the System.....	1-3
	Step 3 Install ESP .....	1-4
	Step 4 Select Scanner Model.....	1-5
	Step 5 Autoconnect .....	1-6
	Step 6 Position Symbol and Scanner .....	1-7
	Step 7 Test for Read Rate.....	1-8
	Step 8 Configure the Scanner .....	1-9
<b>Chapter 2</b>	<b>Using ESP</b>	
	Setup Mode .....	2-2
	Application Mode .....	2-3
	Pulldown Menus .....	2-4
	Making Changes in ESP .....	2-7
	Send/Receive Options.....	2-8
<b>Chapter 3</b>	<b>Communications</b>	
	Communications by ESP.....	3-2
	RS-232/422 Host Port .....	3-3
	RS-232 Auxiliary Port .....	3-9
	Preamble .....	3-15
	Postamble .....	3-16
	LRC Status .....	3-17
	Response Timeout .....	3-18
<b>Chapter 4</b>	<b>Read Cycle</b>	
	Read Cycle by ESP.....	4-2
	Read Cycle by Serial Command .....	4-3
	Multisymbol .....	4-4
	Trigger .....	4-6
	Serial Trigger.....	4-12
	End of Read Cycle .....	4-13
	Good Decode Reads.....	4-16
	Scanner Setup.....	4-17
	Laser Setup .....	4-20
<b>Chapter 5</b>	<b>Symbologies</b>	
	Symbologies by ESP .....	5-2
	Symbologies by Serial Command .....	5-3
	Narrow Margins .....	5-19
	Symbology Identifier.....	5-20
	Background Color.....	5-21
	Autodiscriminate.....	5-22
<b>Chapter 6</b>	<b>Matchcode</b>	

Matchcode by ESP Menu .....	6-2
Matchcode by Serial Command .....	6-2
Overview of Matchcode .....	6-3
Matchcode Type .....	6-4
Sequential Matching .....	6-5
Match Length .....	6-6
Sequence On Noread .....	6-7
Sequence On Mismatch .....	6-8
New Master Pin .....	6-9
<b>Chapter 7</b> <b>OMR</b>	
OMR Setup by ESP Menu .....	7-2
OMR Setup by Serial Command .....	7-2
OMR Description .....	7-3
OMR Definitions .....	7-4
OMR Setup & Calibration Menu .....	7-5
OMR Setup .....	7-6
Static Test .....	7-10
Dynamic Calibration .....	7-11
Calibration Data .....	7-12
Laser Control .....	7-15
<b>Chapter 8</b> <b>I/O Parameters</b>	
I/O Parameters by ESP .....	8-2
I/O Parameters by Serial Command .....	8-2
Symbol Data Output .....	8-3
Noread Message .....	8-6
Beeper .....	8-7
Partial Output .....	8-8
Serial Verification .....	8-9
Operation Command Output .....	8-10
Output 1 Parameters .....	8-11
Output 2 Parameters .....	8-16
Output 3 Parameters .....	8-16
Quality Output .....	8-17
<b>Chapter 9</b> <b>Diagnostics</b>	
Diagnostics by ESP Menu .....	9-2
Diagnostics by Serial Command .....	9-3
Counts .....	9-4
Hours Since Reset .....	9-5
Warning Messages .....	9-6
Present Operating Temperature (deg. C) .....	9-9
High Temperature Threshold .....	9-10
Low Temperature Threshold .....	9-11
Lifetime Hours .....	9-12
<b>Chapter 10</b> <b>Laser Control</b>	

Laser Control by ESP Menu .....	10-2
Laser Control by Serial Command .....	10-2
Laser On/Off .....	10-3
Laser Framing .....	10-4
Laser Off Time.....	10-5
Laser On Time.....	10-6

## Chapter 11 Terminal Mode

Terminal Window.....	11-2
Find Function.....	11-3
Macros.....	11-4
Terminal Window Functions .....	11-5

## Chapter 12 Utilities

Utilities by ESP Menu.....	12-2
Utilities by Serial Command .....	12-3
Read Rate .....	12-5
Counters.....	12-7
Device Control.....	12-9
Master Database .....	12-11
Firmware .....	12-16
Autodiscrimination .....	12-19
Scanner Status Requests.....	12-20

## Appendices

Appendix A General Specifications .....	A-2
Appendix B Electrical Specifications .....	A-5
Appendix C IB-131 Interface Module .....	A-10
Appendix D Serial Configuration Commands.....	A-13
Appendix E Serial Command Format.....	A-16
Appendix F ASCII Table .....	A-18
Appendix G Embedded Menus .....	A-20
Appendix H Defaulting/Saving/Initializing.....	A-21
Appendix I Test Decode Rate .....	A-25
Appendix J Formulas for Number of Decodes.....	A-27
Appendix K Operational Tips.....	A-30
Appendix L Interface Standards .....	A-31
Appendix M Multidrop Communications .....	A-32
Appendix N Glossary of Terms .....	A-37

# List of Figures

Figure 1-1 Hardware Configuration .....	1-2
Figure 1-2 Hardware Configuration .....	1-3
Figure 1-3 Side View of IB-131 showing Host 25-pin Connector .....	1-3
Figure 1-4 Symbol/Scanner Position .....	1-7
Figure 2-1 How Settings are Saved .....	2-4
Figure 4-1 Trigger Level .....	4-8
Figure 4-2 Trigger Edge .....	4-9
Figure 8-1 Read Cycle .....	8-5
Figure 10-1 Laser Framing .....	10-4
Figure 10-2 Laser Framing Sketch .....	10-5
Figure A-1 MS-9	
Dimensions .....	A-2
Figure A-2 MS-9 Mounting .....	A-3
Figure A-3 MS-9	
Read Range Graph .....	A-5
Figure A-4 MS-9 Connector .....	A-5
Figure A-5 IB-131 Mechanical .....	A-11
Figure A-6 MS-9/IB-131 Typical Setup .....	A-11
Figure A-7 IB-131 Multidrop Setup .....	A-12
Figure A-8 Scanner/IB-131 Daisy Chain Setup .....	A-12
Figure A-9 Ladder .....	A-27
Figure A-10 Picket Fence .....	A-28
Figure A-11 Angled	
Picket Fence .....	A-28
Figure A-12 Polling Sequence .....	A-34
Figure A-13 Polling Sequence .....	A-35

# List of Tables

Table 12-1 Summary of Utility Serial Commands .....	12-3
Table 12-2 Maximum Characters for Master Symbol Database .....	12-13
Table 12-3 Hex Value to Binary Conversion .....	12-20
Table 12-4 Scanner Status .....	12-20
Table A-1 MS-9 Status Lights .....	A-4
Table A-2 MS-9 Host Connector, 15-pin .....	A-5
Table A-3 Host 25-pin Connector .....	A-10
Table A-4 Trigger 4-pin Connector .....	A-10
Table A-5 Power 3-pin Connector .....	A-10
Table A-6 Scanner 15-pin Connector .....	A-10
Table A-7 Network 25-pin Connector .....	A-10
Table A-8 Complete List of Serial Configuration Commands .....	A-13
Table A-9 ASCII Table with Control Characters .....	A-18
Table A-10 Communication Protocol Commands .....	A-19
Table A-11 Multidrop Addresses .....	A-36

## *About the MS-9 Scanner*

---

- High speed scanning (2000 scans per minute)
- Only scanner that can read OMR in ladder symbol orientation
- Only scanner that can read OMR in various depths of field
- Can calibrate OMR at speeds up to 200 inches per second

A user interface program, the ESP (Easy Setup Program), can be downloaded from our web site ([www.microscan.com](http://www.microscan.com)) and runs on Windows 98, Windows NT, Windows 2000, or Windows XP operating systems. Alternately, configuration commands can be sent from an embedded, menu-driven terminal program, or directly by host serial command strings.

The scanner is offered as a standalone or in combination with a wiring box. Four optional network plug-in protocol cards are also available when using the wiring box option.



## About This Manual

---

This manual provides complete information on setting up, installing, and configuring the MS-9 scanner. The chapters follow the ESP menus which are presented in the order in which a scanner might be setup and made ready for industrial operation.

**Chapter 1, "Quick Start"** provides overall step-by-step instructions for getting your scanner operational with specific "go to" references to other chapters and appendices.

**Chapter 3, "Communications"** through **Chapter 9, "Diagnostics"** are general setup and configuration options.

**Chapter 10, "Laser Control"** will help you setup your raster and laser framing envelopes.

**Chapter 11, "Terminal Mode"** describes the use of the Terminal window.

The appendices include specifications, reference tables of serial commands, ASCII characters, multidrop setup and addresses, as well as other useful information relating to bar coding and electrical and mechanical setups for the scanner.

### Highlighting

Serial commands, selections inside instructions, and menu defaults are highlighted in **red bold**. Cross-references are highlighted in **blue bold**. Web links and outside references are highlighted in **blue bold italics**. References to menu topics are highlighted in **Bold Initial Caps**. References to topic headings within this manual or other documents are enclosed in quotation marks.

## Host Communications

---

There are four ways the scanner can communicate with a host:

1. Windows based **ESP**, the preferred method which offers point-and-click ease of use and visual responses to user adjustments.
2. Serial commands such as **<K100,r1>** can be sent from a terminal program. They can also be sent from the **Terminal** window within ESP.
3. Embedded onboard menus are accessed from a terminal window with a **<D>** command.
4. Bar code symbol configuration.
5. (See **"Test Decode Rate" on page A-25.**)

In the **App Mode**, click the **Configuration** icon to bring up the configuration views for **Read Cycle**, **Symbologies**, **I/O**, **Match-code** and **Diagnostics**.



For more information, see **"Using ESP" in chapter 2.**

# Approvals

This equipment is in compliance or approved by the following organizations:

- UL (Underwriters Laboratories, Inc.)
- cUL (UL mark of Canada)
- FCC (Federal Communication Commission)
- CE Compliant
- BSMI (Bureau of Standards, Metrology and Inspection)

# Safety Labels

The following labels are located on the side and back of the MS-9 Scanner:

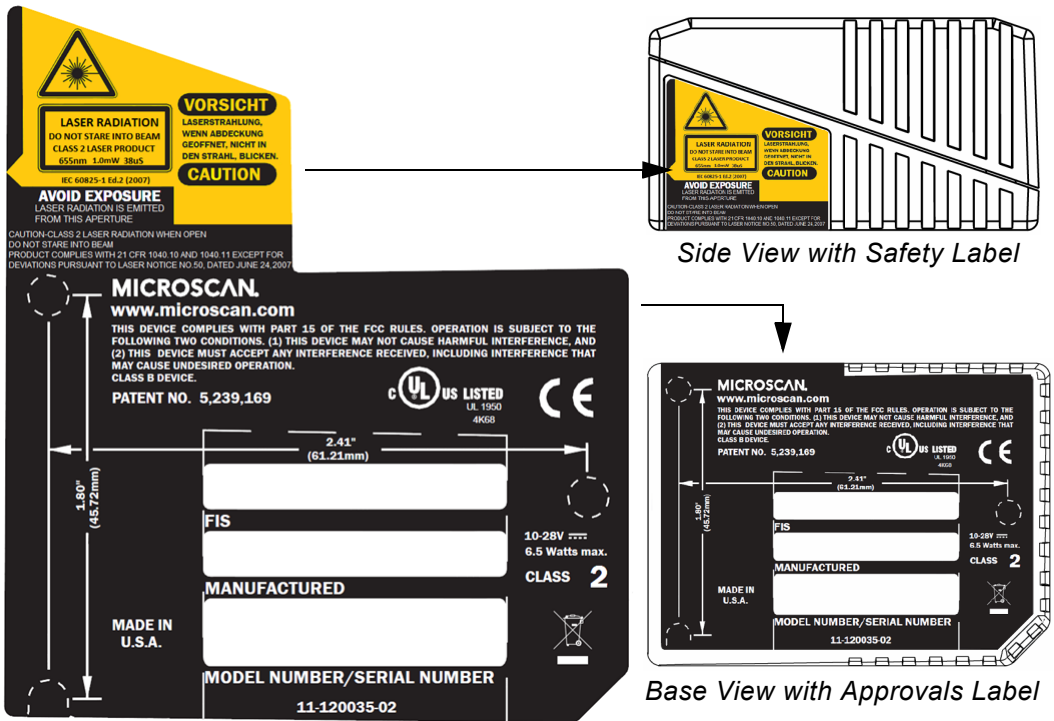

## *Warning and Caution Summary*

---

This equipment has been tested and found to comply with the limits for a Class A digital device, pursuant to part 15 of the FCC Rules. These limits are designed to provide reasonable protection against harmful interference in a residential installation. This equipment generates, uses, and can radiate radio frequency energy, and, if not installed and used in accordance with the instructions, may cause harmful interference to radio communications. However, there is no guarantee that interference will not occur in a particular installation. If this equipment does cause harmful interference to radio or television reception, which can be determined by turning the equipment off and on, the user is encouraged to try to correct the interference by one or more of the following measures:

- Reorient or relocate the receiving antenna
- Increase the separation between the equipment and receiver
- Connect the equipment into an outlet on a circuit different from that to which the receiver is connected
- Consult the dealer or an experienced radio/TV technician for help

For connection to a UL listed direct plug-in power unit marked Class II and rated 10 to 28 VDC at 5 watts or greater.

European models must use a similarly rated Class I or Class II power supply that is certified to comply with standard for safety EN 60950.

---



### **WARNING**

*Use of controls, adjustments, or performance of procedures other than those specified herein may result in hazardous laser light radiation exposure.*



### **WARNING**

*There are no user serviceable parts in the scanner. Opening the scanner voids the Microscan Systems warranty and could expose the user to laser diode power of up to 7 mW.*



### **WARNING**

*The laser beam can be harmful to eyesight. Avoid eye contact with the laser beam. Never point the beam at other people, or in a direction where people may be passing.*

---

# Statement of RoHS Compliance

All Microscan readers with a 'G' suffix in the FIS number are RoHS-Compliant. All compliant readers were converted prior to March 1, 2007. All standard accessories in the Microscan Product Pricing Catalog are RoHS-Compliant except 20-500013-01 and 98-000039-02. These products meet all the requirements of "Directive 2002/95/EC" European Parliament and the Council of the European Union for RoHS compliance. In accordance with the latest requirements, our RoHS-Compliant products and packaging do not contain intentionally added Deca-BDE, Perfluorooctanes (PFOS) or Perfluorooctanic Acid (PFOA) compounds above the maximum trace levels. To view the document stating these requirements, please visit:

<http://eur-lex.europa.eu/LexUriServ/LexUriServ.do?uri=CELEX:32002L0095:EN:HTML>

and

<http://eur-lex.europa.eu/LexUriServ/LexUriServ.do?uri=OJ:L:2006:372:0032:0034:EN:PDF>

Please contact your sales manager for a complete list of Microscan's RoHS-Compliant products.

This declaration is based upon information obtained from sources which Microscan believes to be reliable, and from random sample testing; however, the information is provided without any representation of warranty, expressed or implied, regarding accuracy or correctness. Microscan does not specifically run any analysis on our raw materials or end product to measure for these substances.

The information provided in this certification notice is correct to the best of Microscan's knowledge at the date of publication. This notice is not to be considered a warranty or quality specification. Users are responsible for determining the applicability of any RoHS legislation or regulations based on their individual use of the product. In regards to "RoHS Directive 2011\_65\_EU" Microscan produces Monitoring and Control Instruments as well as Industrial Monitoring & Control Instruments as defined within the directive. Microscan has developed and is implementing a RoHS2 compliance plan with the intention of bringing all active products listed in our current marketing literature within full compliance as per the directive deadlines.

Key milestones for the transition plan are as follows:

- Complete internal product audit by July 2014.
- Initial "Monitoring and Control Instruments" RoHS2 compliant products available by December 2014
- Initial "Industrial Monitoring & Control Instruments" RoHS2 compliant products available by July 2015
- All new products introduced in 2015 are expected to be WEEE & RoHS2 compliant.

Microscan will mark the products with the 'CE' marking that complies with the RoHS2 process to acquire 'CE' certification per the example given: Example >> Machinery directive + EMC directive + RoHS2 = Declaration of Conformity.

# Chapter

# 1

# Quick Start

## Chapter Contents

Step 1 Hardware Required .....	1-2
Step 2 Connect the System .....	1-3
Step 3 Install ESP .....	1-4
Step 4 Select Scanner Model .....	1-5
Step 5 Autoconnect .....	1-6
Step 6 Position Symbol and Scanner .....	1-7
Step 7 Test for Read Rate .....	1-8
Step 8 Configure the Scanner .....	1-9

This chapter is designed to get your scanner up and running quickly using Microscan's **ESP** so the user can get a sense of its capabilities and test bar code symbol samples. Detailed setup information for installing the scanner into the actual application can be obtained in the subsequent chapters. **ESP** is Microscan's proprietary **E**asy **S**etup **P**rogram, a Windows based graphic user interface that resides on the User host computer and allows the user to fully configure, test, and operate Microscan's 1D and 2D symbology scanners.

As an alternative to **ESP**, you can setup the scanner by sending serial commands or by using the scanner's embedded menus.

# Step 1 — Hardware Required

(Refer to [figure 1-1.](#))

Item	Part Number	Description
1	FIS-0911-XXXXG	MS-9 Laser Scanner
2		Host Computer <sup>a</sup>
3	61-300026-03	Cable, Communication, DB-25 Plug to DB-9 Socket, 6 foot. <sup>b</sup>
4	99-000018-01	IB-131 interface Box
5	97-100004-15 (90-264 VAC, 24VDC)	Power supply
6	99-000017-01	Optional object detector

- a. With either a terminal communications program or Microscan's ESP which runs under Windows operating system, Windows 98 or higher, including Windows NT and Windows XP.
- b. If using another host cable, make certain it does not have RTS/CTS connected to the host.

**Caution:** If using your own power supply, be certain that it is wired correctly and supplies voltage is within the +10 to 28VDC limits. Incorrect wiring or voltage can cause software or equipment failures.

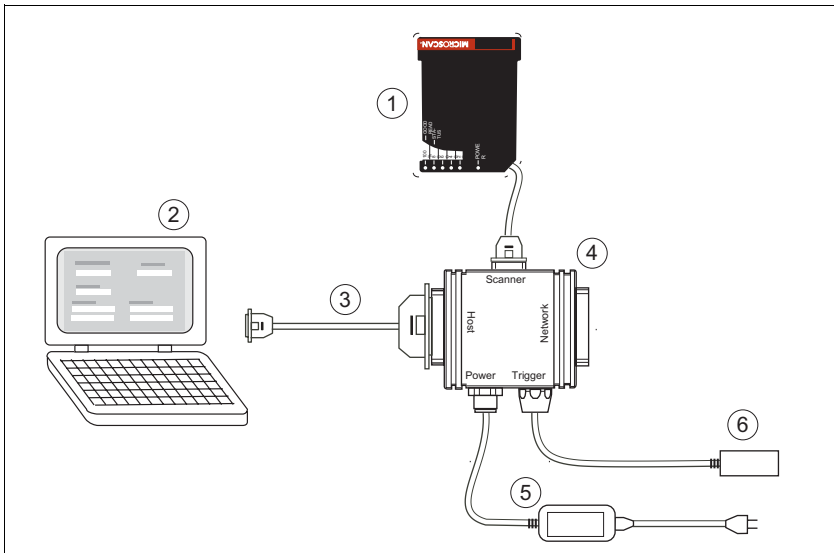

Figure 1-1 Hardware Configuration

## Step 2 — Connect the System

(Refer to [figure 1-3](#).)

1. Connect the scanner (1) to the IB-131 interface box (4).
2. Connect the IB-131 (4) at the "HOST" 25-pin connector to the computer (2) via a null modem cable (3).<sup>1</sup>
3. Connect the power supply (5) to the IB-131's POWER connector. (Refer to "[IB-131 Interface Module](#)" on page A-10 for pin connections.)
4. Apply power to the system.

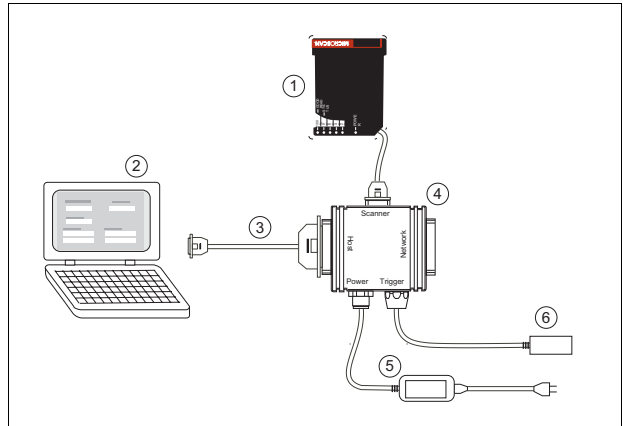

Figure 1-2 Hardware Configuration

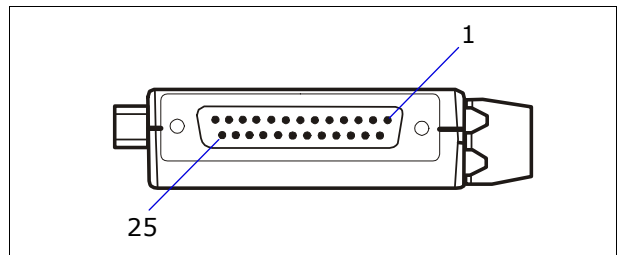

Figure 1-3 Side View of IB-131 showing Host 25-pin Connector

### Caution:

1. Be sure all cables are connected **BEFORE** applying power.
2. Always power down **BEFORE** disconnecting any cables.

1. When wiring the IB-131 to a host computer which has a 25-pin connector, cross pins 2 and 3. When wiring the IB-131 to a host computer which has a 9-pin connector, do NOT cross pins 2 and 3.

## Step 3—Install ESP

(**ESP** stands for Easy Setup Program.)

Once your scanner is connected to a host computer with Windows™ operating system (XP or above), you can use **ESP** (Easy Setup Program) for configuration and control.

### **To install ESP from the Microscan Tools Drive:**

- Insert your Microscan Tools Drive into a USB port on your computer.
- Click **Setup.exe** and follow the prompts.

### **To download ESP from the Web:**

- Go to [www.microscan.com](http://www.microscan.com).
- Click **Setup.exe** and follow the prompts.
- At the end of the install process, copy a shortcut **ESP** icon onto your desktop.



- Click the **ESP** icon to run the program.

## Minimum System Requirements

- 233 MHz Pentium PC
- Windows 8, 7, Vista, or XP operating system (32-bit or 64-bit)
- Internet Explorer 6.0 or higher
- 128 MB RAM or greater
- 160 MB free disk space
- 800 x 600 256 color display (1024 x 768 32-bit color recommended)



## Step 4 — Select Scanner Model

When you start the program, the following menu will appear:

**Note:** If you need to select another model later, you can find it in the **App Mode** under **Model** on the menu bar.

1. In the **Model** dialog box, select your model.

If you do not want to make this selection every time you load ESP, uncheck **Show this window at Startup**.

2. Select the default name, for example **MS-9-1**, or type in a file name of your choice and click **OK**.
3. Click **Yes** when the **connect to the scanner** dialog appears.



## Step 5 — Autoconnect

1. In the **Connecting to...** dialog, select your communications port under **COM Port**.
2. Click the **Start** button.
3. Allow time for the autoconnect routine to test all of the combinations. You will see a blue progress bar fill across the **Connecting to...** dialog.

When connected, the **CONNECTED** message will appear in a green box in the status bar on the bottom right of the dialog.

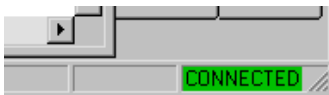

**Tip:** If connection fails, enable a different Com port and try again.

**Tip:** If you do not see either the CONNECTED or DISCONNECTED message at the bottom of your dialog, try expanding the ESP window horizontally.

## Step 6 — Position Symbol and Scanner

1. Set up a bar code symbol<sup>1</sup> at the scanning distance you will be using in your application.<sup>2</sup>
2. Avoid bright light or IR light from other sources, including other scanners.
3. Pitch symbol or scanner a minimum of  $\pm 15^\circ$  to avoid specular reflection, the return of direct, non-diffused light.

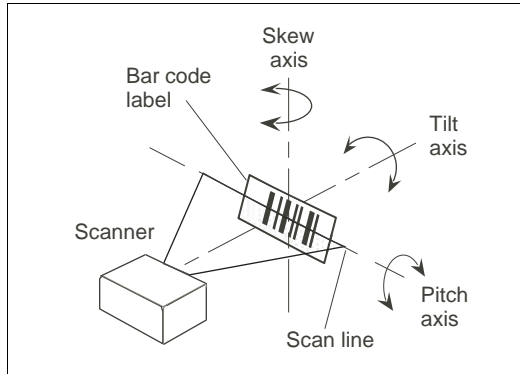

Figure 1-4 Symbol/Scanner Position

For read ranges, see [figure A-3 on page A-5](#).

**Code 39** is the default symbol type enabled. If you are uncertain as to your symbology type, enable all codes (see [“Autodiscriminate” on page 5-22](#)).

1. If using an I 2/5 symbol, verify that the number of characters in the symbol being scanned matches the symbol length enabled for the I 2/5 symbol type (default is 10 and 6). See [“Interleaved 2 of 5” on page 5-8](#).
2. Consult [“LED Indicators” on page A-4](#).

## Step 7 — Test for Read Rate

If you don't have a test symbol, print out this page and use the symbol here for testing. With this test you can learn the percentage of decodes per images captured by observing the LEDs (20% through 100%) on the top of the scanner which are active during a read rate test.



20 mil Code 39 Test Symbol

### By ESP

After connecting to the scanner, ESP will open in **Setup Mode**.

1. Click the **Test** button in Setup Mode to begin the read rate test.

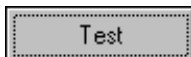

2. Follow the instructions in **Setup Mode** screen.
3. To end the **Read Rate** test, click the **Stop** button.

**Note:** If the scanner is in the default **Continuous Read** mode, it will read and beep repeatedly as long as a readable symbol remains in the read range and the read cycle configuration has not changed.

**Note:** See "[Formulas for Number of Decodes](#)" on page A-27 for additional information on scan width and depth of field.

### By Serial Commands

Send an **<C>** to begin the read rate test.

Send a **<J>** to end the read rate test.

## Step 8 — Configure the Scanner

### By ESP

To make change scanner settings, or to access the utilities or terminal window, click on the **App Mode** button.

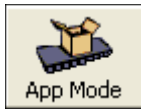

To return to the **Setup Mode**, click on the **Setup Mode** button.

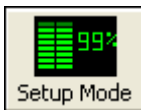

See [Chapter 2, "Using ESP"](#) for detailed explanation of ESP features.

### By Serial Commands

From your terminal program or the terminal screen in ESP, you can enter serial string commands configuration and utility commands as described herein.

See ["Serial Configuration Commands" on page A-13](#) and ["Summary of Utility Serial Commands" on page 12-3](#).

**Note:** You can learn the current setting of any parameter by inserting a question mark after the number, as in **<KA?>** To see all "K" commands, send **<K?>**.

### By Embedded Menu

From your terminal program you can send a **<D>** command to access the embedded menus.

See ["Embedded Menus" on page A-20](#).



# Chapter

# 2

# Using ESP

## Chapter Contents

Setup Mode .....	2-2
Application Mode .....	2-3
Pulldown Menus .....	2-4
Making Changes in ESP .....	2-6
Send/Receive Options .....	2-7

This section is designed to help you understand the structure, elements, and application of the ESP (Easy Setup Program).

When you start up ESP, unless otherwise specified, you will enter the **Setup Mode** for initial setup. From there, you move easily into the **App Mode** (application mode) where you can access several configuration and utilities menus.

# Setup Mode

In **Setup Mode** you are presented with the **Test** option and if appropriate for your application, **Calibration**. After connecting to your scanner (or scanner) the **Setup Mode** will first appear. This will provide you with instructions specific to your model that will help you in positioning, testing, and if appropriate, calibrating.

## Test

Click the **Test** button to start the read rate test for a quick indication of the read capabilities and the limits of your application. When **Decodes per Second** is unchecked, the test will count the percentage of decodes relative to the number of actual scans. Click **Stop** to end the test.

## Calibrate

Some models include a calibration routine that will optimize reads by comparing read rates at various settings in focal lengths, scan speeds, and gain settings.

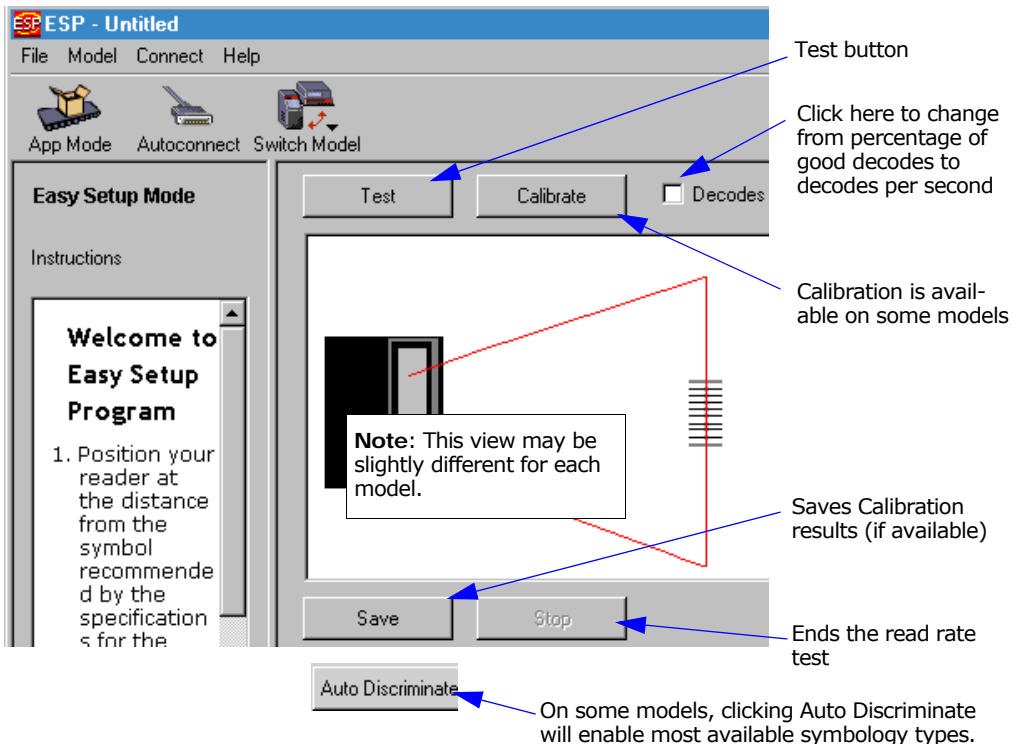



# Application Mode

From **Setup Mode**, you can click on the **App Mode** button to access specific configuration menus, utilities, and a terminal window where serial commands can be entered.



Note that the **App Mode** and **Setup Mode** buttons appear in the same position to allow easy switching between these primary modes.

The screenshot shows the ESP software interface with several annotations:

- Pull-down menus:** Points to the menu bar (File, Model, Options, Connect, View, Help).
- Click this icon to return to Setup Mode:** Points to the 'Setup Mode' icon in the operations bar.
- Click this icon to return to this view from Utilities or Terminal:** Points to the 'Configuration' icon in the configuration bar.
- Click on icons in this toolbar to access configuration menu trees to make specific changes in configuration:** Points to the 'Communication' icon in the configuration bar.
- The icons on this toolbar are for operations:** Points to the 'Autoconnect', 'Send/Recv', and 'Switch Model' icons in the operations bar.
- Click here to open a terminal window:** Points to the 'Terminal' icon in the configuration bar.
- Click here to access read rate and other utilities:** Points to the 'Utilities' icon in the configuration bar.

The interface includes a 'Parameters' section with a tree view showing 'Communications' > 'RS232/422 Host Port' > 'Host Port Connections' > 'Baud Rate' set to 9600. A status bar at the bottom shows 'Ready', 'MS-880-1', and 'MS-880'. A note box states: 'Note: This view may be slightly different for each model.'

**Note:** For specific information on any of the icons shown above in the operations bar or configuration bar, see specific chapters in this document.

# Pulldown Menus

## File

### New

Whenever **New** is selected, the default configuration of ESP is loaded.

### Open/Save

When **Save** or **Save As** is selected, the ESP configuration is saved to the host computer's hard drive and available whenever the same file is selected under **Open**.

**Important:** When you save menu changes to your hard drive, these changes are not saved to your scanner. **Figure 2-1** shows how settings can be saved and received between ESP and the scanner and ESP and the host hard drive.

File	Model	Options	Co
New		Ctrl+N	
Open...		Ctrl+O	
Save		Ctrl+S	
Save As...			
Print...		Ctrl+P	
Import...			
Export...			
Recent File			
Exit			

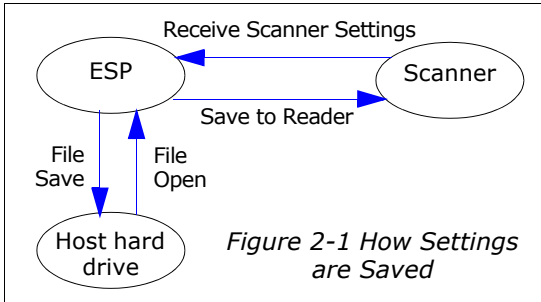

### Import/Export

**Export** converts the active ESP configuration settings to an ASCII text file. **Import** converts the ASCII settings from a text file to ESP configuration settings.

## Model

When you select **New Model**, you can define configuration settings for another model. When you save to the hard drive, you will be saving the settings of all the models defined in a single ESP file.

Model	Options	Co
MS-9		▶
New Model...		

## Options

You can use the **Options** menu to tell ESP how you wish it to perform at startup.

**Note:** The settings you select here will be saved and be loaded into ESP when ESP is opened next, whether or not you save the ESP file to the computer.

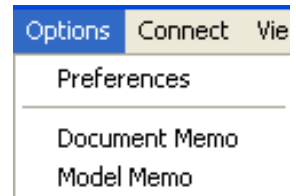

### *Preferences*

Opens a dialog box that allows you to determine how you want ESP to behave on Startup.

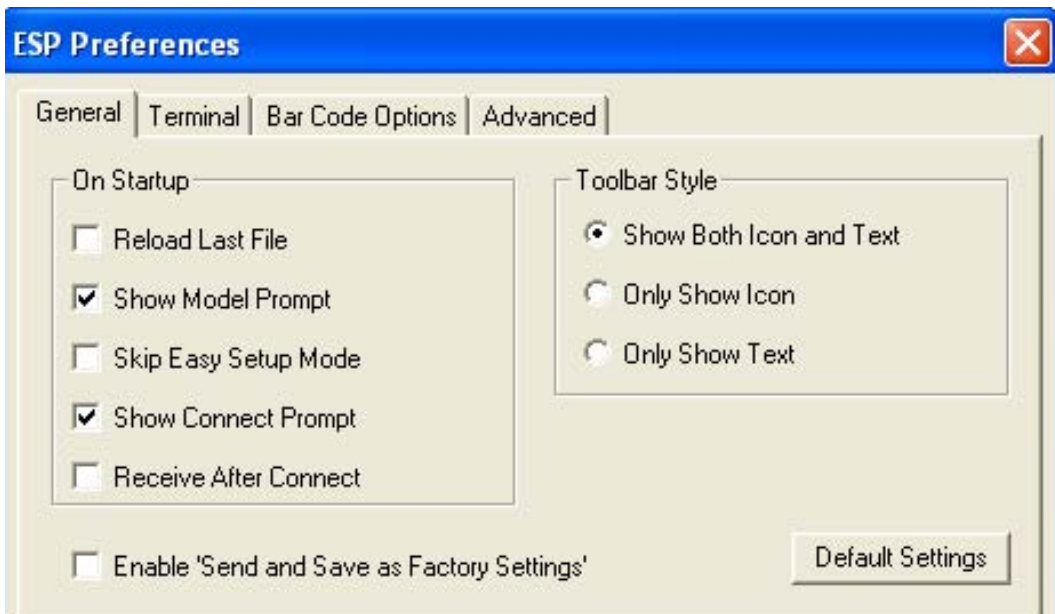

### *Document Memo (Options menu)*

Allows you to describe a new document.

### *Model Memo (Options menu)*

Allows you to describe the model currently in use.

## Connect

Generally **Autoconnect** will be the quickest way that ESP can get connected to a scanner. **Autoconnect** will try connecting at the most common communications settings and step through the various settings until they match up with the host's settings.

When you select **Connect**, you will need to manually select the communications settings from a popup dialog.

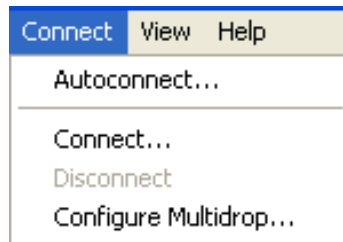

## View

View tells you what view is current and allows you to quickly move to other views which are also accessed by clicking the icons on the toolbars.

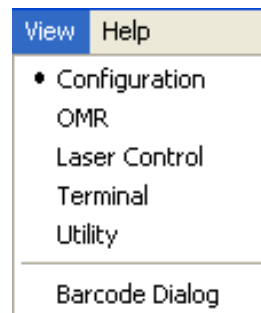

# Making Changes in ESP

To change scanner settings, or to access the utilities or terminal window, click on the **App Mode** button.



To return to the **Setup Mode**, click on the **Setup Mode** button.

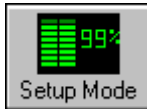

See the succeeding chapters and Appendices to see specific configuration command explanations for both ESP and serial commands.

To make changes to a configuration setting in the menu trees:

1. **Left click** on the + to expand tree
2. **Double click** on parameter and click once in selection box to view options.
3. Place your cursor in the selection box, scroll down to the setting you want to change and **click** once on the setting.
4. **Left click** again on the open screen to complete the selection.
5. **Right click** on the open screen and select **Save to Reader** to implement the command in the scanner.

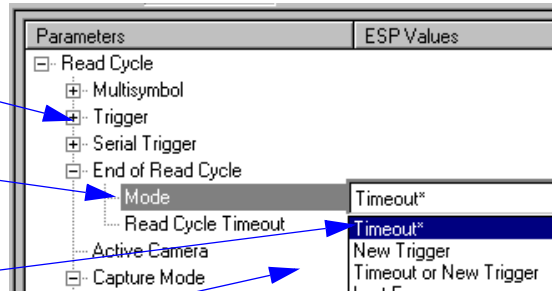

# Send/Receive Options

To access save and receive options, from the **Configuration** views click the **Send/Recv** button:



You can also access this selector by right-clicking in any of the configuration views.

## Saving

You have 3 choices for saving:

1. **Send, No Save.**

This saves ESP settings to current memory.

2. **Send and Save.**

This activates all changes in current memory **and** saves to the scanner for power-on. (Similar to the <Z> command.)

3. **Send and Save, Including Factory.** Includes all settings including changes to factory settings.

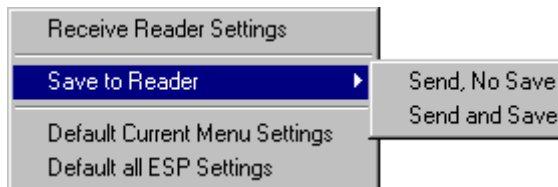

For **Multidrop** setup, see [“Multidrop Communications” on page A-32.](#)

For **Matchcode** setup, see [Chapter 6, “Matchcode.”](#)

For more on defaulting and saving settings, see [“Defaulting/Saving/Initializing” on page A-21.](#)

## Receiving

From the **Send/Recv** selector select **Receive Scanner Settings.**

This is useful if you want to receive (upload) the scanner’s settings and save them as a computer file for later retrieval and to verify that your ESP settings have been saved or that you have not saved any unwanted changes that you or someone else previously made in ESP.

## Defaulting

When you select **Default Current...** or **Default all ESP...** you are only defaulting the ESP settings. To default the scanner, see [“Defaulting/Saving/Initializing” on page A-21](#) for a more information.

# Chapter

# 3

# Communications

## Chapter Contents

Communications by ESP .....	3-2
RS-232/422 Host Port .....	3-3
RS-232 Auxiliary Port .....	3-9
Preamble .....	3-16
Postamble.....	3-17
LRC Status .....	3-18
Response Timeout .....	3-19
Intercharacter Delay .....	3-20

With Microscan's ESP™ (Easy Setup Program), configuration changes can be made in the ESP menus, then sent and saved to your scanner. The user can also send serial commands to the scanner via the ESP's Terminal window.

This section includes connecting parameters and options for communicating by the auxiliary port and various interfaces.

**Note:** When assigning characters in user-defined fields, the characters **NULL <>** and **,** can only be entered through embedded menus, not through ESP or serial commands.

**Note:** Default settings for establishing communications are:

Baud = **9600**  
Parity = **Even**  
Stop Bits = **One**  
Data Bits = **Seven**  
Flow Control = **None**

# Communications by ESP



Click this button to bring up the **Communications** menu.

To open nested options, **single-click** the +.

To change a setting, **double-click** the setting and use your cursor to scroll through the options.

Parameters	ESP Values
[-] Communications	
[-] RS232/422 Host Port	
[-] Host Port Connections	
Baud Rate	9600
Parity	Even
Stop Bits	One
Data Bits	Seven
Host Protocol	Point-to-Point
Host 422 Status	Disabled
[+] RS232 Auxilliary Port	
[+] Preamble	Disabled
[+] Postamble	Enabled
LRC	Disabled
Response Timeout	2
Intercharacter Delay	0



# RS-232/422 Host Port

Includes host port connections and host protocols.

## *Host Port Connections*

---

### Baud Rate, Host Port

*Usage:* Can be used to transfer data faster or to match host port settings.

*Definition:* The rate at which the scanner and host transfer data back and forth.

*Serial Cmd:* <**K101**,aux port mode,**baud rate**,parity,stop bits,data bits,daisy chain ID status,daisy chain ID>

*Default:* **9600**

<i>Options:</i>	1 = 1200	4 = 9600	7 = 57.6K
	2 = 2400	5 = 19.2K	8 = 115.2K
	3 = 4800	6 = 38.4K	

### Parity, Host Port

*Usage:* Only changed if necessary to match host setting.

*Definition:* An error detection routine in which one data bit in each character is set to 1 or 0 so that the total number of 1 bits in the data field is even or odd.

*Serial Cmd:* <**K100**,baud rate,**parity**,stop bits,data bits>

*Default:* **Even**

<i>Options:</i>	0 = None	1 = Even	2 = Odd
-----------------	----------	----------	---------

### Stop Bits, Host Port

*Usage:* Only changed if necessary to match host setting.

*Definition:* One or two bits added to the end of each character to indicate the end of the character.

*Serial Cmd:* <**K100**,baud rate,parity,**stop bits**,data bits>

*Default:* **One**

<i>Options:</i>	0 = One	1 = Two
-----------------	---------	---------

## Data Bits, Host Port

*Usage:* Only changed if necessary to match host setting.

*Definition:* Number of bits in each character.

*Serial Cmd:* <**K100**,baud rate,parity,stop bits,**data bits**>

*Default:* **Seven**

*Options:* 0 = Seven                    1 = Eight

---

## Host Protocol

*Usage:* In general, the point-to-point protocols will work well in most applications. They require no address and must use RS-232 or RS-422 communications standards.

*Definition:* Protocols define the sequence and format in which information is transferred between the scanner and the host, or in the case of **Multidrop**, between scanners and a concentrator.

*Serial Cmd:* <**K140**,protocol>

*Default:* **Point-to-Point**

*Options:* 0 = Point-to-Point                    4 = Polling Mode D  
1 = Point-to-Point with RTS/CTS        5 = Multidrop  
2 = Point-to-Point with XON/XOFF      6 = User Defined  
3 = Point-to-Point with RTS/CTS & XON/XOFF    7 = User Defined Multidrop

If selecting one of the options from 0 to 4 (**Point-to-Point**, **Point-to-Point with RTS/CTS**, **Point-to-Point with XON/XOFF**, **Point-to-Point with RTS/CTS and XON/XOFF**, or **Polling Mode D**), use the <**K140**,protocol> format.

Option 5 through 7 are special cases and discussed later in this section.

## Point-to-Point (standard)

*Usage:* Used only with RS-232 or RS-422.

*Definition:* Standard **Point-to-Point** requires no address and sends data to the host whenever it is available, without any request or handshake from the host.

*Serial Cmd:* <**K140**,0>

## Point-to-Point with RTS/CTS

*Usage:* A scanner initiates a data transfer with an RTS (request-to-send) transmission. The host, when ready, responds with a CTS (clear-to-send) and the data is transmitted. CTS and RTS signals are transmitted over two dedicated wires as defined in the RS-232 standard.

Used only with RS-232.

*Definition:* **Point-to-Point with RTS/CTS** (request-to-send/clear-to-send) is a simple hardware handshaking protocol that allows a scanner to initiate data transfers to the host.

*Serial Cmd:* <K140,1>

## Point-to-Point with XON/XOFF (Transmitter On/Off)

*Usage:* If an XOFF has been received from the host, data will not be sent to the host until the host sends an XON. During the XOFF phase, the host is free to carry on other chores and accept data from other devices.

Used only with RS-232.

*Definition:* This option enables the host to send the XON and XOFF command as a single byte transmission command of start (^Q) or stop (^S).

*Serial Cmd:* <K140,2>

## Point-to-Point with RTS/CTS & XON/XOFF

*Usage:* Used only with RS-232.

*Definition:* This option is a combination of **Point-to-Point with RTS/CTS** and **Point-to-Point with XON/XOFF**.

*Serial Cmd:* <K140,3>

## Polling Mode D

*Usage:* When in **Polling Mode D**, an address of 1 is automatically displayed on the configuration screen. However, during transmission, a 1C hex poll address (FS) and a 1D hex select address (GS) are substituted for the 1.

*Definition:* Like **Point-to-Point**, **Polling Mode D** requires a dedicated connection to the host; but unlike **Point-to-Point**, it requires an address and must wait for a poll from the host before sending data.

*Serial Cmd:* <K140,4>

## Multidrop

Note: See also “[Multidrop Communications](#)” on page A-32.

*Usage:* The MS-5000 can be used as a concentrator to a single host port connection.

*Definition:* **Multidrop** allows up to 50 devices to be connected to a single RS-485 host, with the scanner assigned an unique address (from 01 to 50). When **Multidrop** is selected, the protocol characters for RES, REQ, etc. are assigned automatically.

*Multidrop Addresses:* Each address has its own separate poll and select address (from 1C to 7F hex).

*Options:* 01 through 50

*Serial Cmd:* If selecting **Multidrop** <K140,5> fan address must be defined and appended to the command string.

Format: <**K140,5**,address[01 to 50]>

**Note:** Scanners linking up to a Microscan MS-5000 multidrop concentrator must be configured in standard multidrop protocol.

## User Defined Point-to-Point

*Usage:* Used for developing custom protocols in polled or unpolled mode.

*Definition:* **User Defined Point-to-Point** allows the user to customize the point-to-point protocol.

*Serial Cmd:* <**K140,6**,RES,address,REQ,EOT,STX,ETX,ACK,NAK,from host>

### User Defined Address

*Definition:* **User Defined** is considered to be in a polled mode only if an address has been assigned.

*Serial Cmd:* <**K140,6**,RES,**address**,REQ,EOT,STX,ETX,ACK,NAK,from host>

*Default:* No address

*Options:* Any ASCII character except a null.

### User Defined Example

*Example:* An ACK/NAK protocol can be configured using **User Defined**. The scanner will transmit data to the host when an **ACK** is received. If a **NAK** or response timeout occurs, the scanner will re-send the data to the host up to 3 more times before aborting.

*Serial Cmd:* <**K140,6**,RES,address,**REQ,EOT,STX,ETX,ACK,NAK**,from host>

*Default:* **No assignment**

*Options:* Any ASCII character except a null. Control characters can be used to define RES through NAK in serial commands.

*From Host*

*Definition:* Allows the handshaking protocol to be initiated from the host, if not configured in an unpolled mode. Messages sent to the host will include the scanner's defined protocol. The status of **From Host** determines if messages sent from the host to the scanner must include the defined protocol. If **From Host** is disabled, the defined protocol is not included. If **From Host** is enabled, the defined protocol must be included.

*Serial Cmd:* <**K140,6,RES,address,REQ,EOT,STX,ETX,ACK,NAK,from host**>

*Default:* **Disabled**

*Options:* 0 = Disabled          1 = Enabled

## User Defined Multidrop

**Note:** Any ASCII character except a null (00) and a ^A (01) can be assigned as an address. Control characters can be used to define RES through NAK in serial commands. See (See [“Communication Protocol Commands” on page A-19.](#))**Note:**

*Usage:* Used when connecting to a concentrator or other device that does not match standard multidrop protocol.

*Definition:* **User Defined Multidrop** allows the user to customize the polling protocol. If selecting **User Defined Multidrop** (7), complete the format by either choosing new parameters or place commas where unchanged data fields occur.

*Serial Cmd:* **<K140,7,RES,address,REQ,EOT,STX,ETX,ACK,NAK>**

For **User Defined Multidrop**, first select **Multidrop <K140,5>**, then **User Defined Multidrop <K140,7...>**.

*Address:* Any single character (02 hex to 7E hex) in the ASCII table can be assigned as the address character. The character chosen is used as the poll character and the subsequent ASCII character becomes the select character. For example, if a ^B (02 hex) is selected as the address, ^C (03 hex) becomes the select address that the host will use in sending host select commands.

Definitions of commands in **User Defined** and **User Defined Multidrop** must be duplicated in host applications to enable poll and select sequences to execute correctly during transmission.

**Note:** Typically, parameters in **User Defined Multidrop** are defined by first enabling **Multidrop**, then enabling **User Defined Multidrop**. This pre-loads multidrop characters into the parameters. Then changes are made to individual characters to match the host or other requirements.

---

## Host RS-422 Status

*Usage:* Only changed if necessary to match host setting.

*Definition:* Enables RS-422. When RS-422 is enabled, RS-232 is disabled.

*Serial Cmd:* **<K102,status>**

*Default:* **Disabled**

*Options:* 0 = Disabled      1 = Enabled

## RS-232 Auxiliary Port

**Note:** The aux port cannot be used when the host port is set to **RS-422** or **Multidrop**. As with the host port parameters, the auxiliary terminal's settings (baud rate, parity, stop bits, and data bits) must be identical with those of the auxiliary device.

**Usage:** These commands set the communication parameters with the auxiliary port which can be used to configure menus, send data to the host, display data transmissions originating from the host of the scanner, and relay data from other scanners set in tandem (daisy chained).

**Definition:** An auxiliary port connects the scanner to a remote display or to other scanners that can display or transfer data.

### Aux Port Connections

As with the host port parameters, the auxiliary terminal's settings (baud rate, parity, stop bits, and data bits) must be identical with those of the auxiliary device.

#### Baud Rate, Aux Port

**Usage:** Can be used to transfer data faster or match an auxiliary device.

**Definition:** The rate at which the scanner and host transfer data back and forth.

**Serial Cmd:** <**K101**,aux port mode,**baud rate**,parity,stop bits,data bits,daisy chain ID status,daisy chain ID>

**Default:** **9600**

<b>Options:</b>	1 = 1200	4 = 9600	7 = 57.6K
	2 = 2400	5 = 19.2K	8 = 115.2K
	3 = 4800	6 = 38.4K	

#### Parity, Aux Port

**Usage:** Only changed if necessary to match host setting.

**Definition:** An error detection routine in which one data bit in each character is set to 1 or 0 so that the total number of 1 bits in the data field is even or odd.

**Default:** **Even**

**Options:** <**K101**,aux port mode,baud rate,**parity**,stop bits,data bits,daisy chain ID status,daisy chain ID>

**Serial Cmd:** 0 = None                      1 = Even                      2 = Odd

#### Stop Bits, Aux Port

**Usage:** Only changed if necessary to match host setting.

---

## RS-232 Auxiliary Port

**Definition:** Allows the user to select the last one or two bits in each character to indicate the end of the character.

**Serial Cmd:** <**K101**,aux port mode,baud rate,parity,**stop bits**,data bits,daisy chain ID status,daisy chain ID>

**Default:** **One**

**Options:** 0 = One                      1 = Two

## Data Bits, Aux Port

**Usage:** Only changed if necessary to match host setting.

**Definition:** Number of bits in each character.

**Serial Cmd:** <**K101**,aux port mode,baud rate,parity,stop bits,**data bits**,daisy chain ID status,daisy chain ID>

**Default:** **Seven**

**Options:** 0 = Seven                      1 = Eight

## Aux Port Mode

---

**Note:** The aux port interacts only with the host port via the 25-pin port except when in **Daisy Chain** mode. When in **Daisy Chain** mode, the aux port will also interact with the configuration port (9-pin port) or the wiring box network ports.

**Definition:** Determines the flow of data between the auxiliary port device(s), the scanner, and the host.

**Serial Cmd:** <**K101**,aux port mode,baud rate,parity,stop bits,data bits,daisy chain ID status,daisy chain ID>

**Default:** **Disabled**

**Options:**

0 = Disabled	3 = Full duplex
1 = Transparent	4 = Daisy chain
2 = Half duplex	5 = Command Processing



## Transparent Mode

**Usage:** Often used in conjunction with handheld scanners. Employs an auxiliary readout to detect mis-applied bar code symbols.

**Definition:** In **Transparent** mode data is passed between the auxiliary port and the host. The scanner buffers data from the auxiliary port and echoes the keyed data on the auxiliary port. I

### Data initiated from the Auxiliary Port

- Auxiliary port data is passed through to the host whenever a return key is pressed at the auxiliary port or symbol data is sent.
- Whenever aux port data is sent with symbol data, the aux port data will appear between the preamble and the symbol data.
- Auxiliary port data to the host is always sent with a preamble and a postamble.
- If the scanner is in a polled mode to the host, auxiliary port data will NOT pass through.
- **<D>** is the only command accepted by the scanner from the auxiliary port. All other commands will pass through to the host.

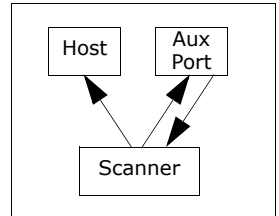

### Data initiated from the Scanner

- Transmission to the auxiliary port occurs immediately upon a good read.
- Scan data to the auxiliary port does not include a preamble or a postamble.
- Communications with the auxiliary port is always in Point-to-Point protocol, even if the host is in a polled protocol mode.

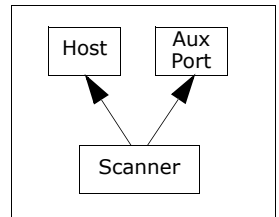

### Data initiated from the Host

- All host data is echoed to the auxiliary port in unpolled mode.

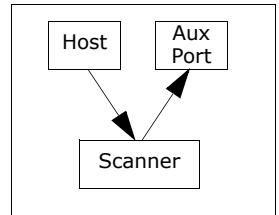

**Serial Cmd:** **<K101,aux port mode,baud rate,parity,stop bits,data bits,daisy chain ID status,daisy chain ID>**

**1 = Transparent**

## Half Duplex Mode

**Usage:** Used to display symbol data on an auxiliary screen close to the scanner.

## RS-232 Auxiliary Port

**Definition:** In **Half Duplex** mode all auxiliary port data and symbol data is sent directly to the host. Symbol data is displayed on the auxiliary port screen at the same time the data is sent to the host.

### Data initiated from the Auxiliary Port

- Auxiliary port data to the host is ignored if the scanner is in a polled mode.
- Auxiliary port data or scanned data is sent to the host whenever it is received.
- Auxiliary port data is not echoed.
- Auxiliary port data to the host is always sent without a preamble or a postamble.
- **<D>** is the only command that is accepted by the scanner from the auxiliary port. All other commands are passed through to the host.

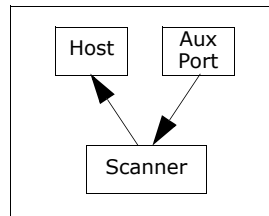

### Data initiated from the Scanner

- Scan data is transmitted to the auxiliary port at the same time it is transmitted to the host.
- Data transmission conforms with all parameters specified in the configuration menu (e.g., **Preamble, Postamble, End of Read Cycle**).

### Data is initiated from the Host

- All host data is echoed to the auxiliary port in unpolled mode.

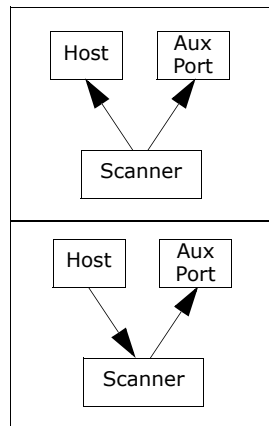

**Serial Cmd:** **<K101,aux port mode,baud rate,parity,stop bits,data bits,daisy chain ID status,daisy chain ID>**

**2 = Half Duplex**

## Full Duplex Mode

*Usage:* Used when communication to and from the auxiliary port is required.

*Definition:* In **Full Duplex** mode all auxiliary port data and symbol data is sent directly to the host. Symbol data is not displayed on the auxiliary port screen.

Data initiated from the Auxiliary Port.

- Auxiliary port data to the host is ignored if the scanner is in a polled mode.
- Auxiliary port data or scanned data is sent to the host whenever it is received.
- Auxiliary port data is not echoed.
- Auxiliary port data to the host is always sent without a preamble or a postamble.
- **<D>** is the only command that is accepted by the scanner from the auxiliary port. All other commands are passed through to the host.

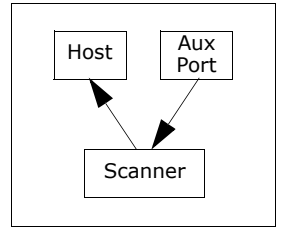

Data initiated from the Scanner.

- Scan data is not sent to the auxiliary port.

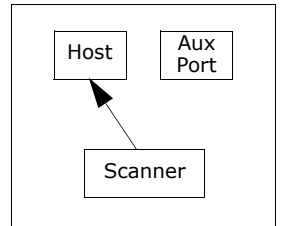

Data initiated from the Host

All host data is echoed to the auxiliary port in unpolled mode.

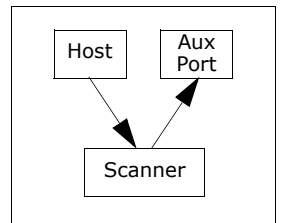

*Serial Cmd:* **<K101,aux port mode,baud rate,parity,stop bits,data bits,daisy chain ID status,daisy chain ID>**

**3 = Full duplex**

**Conditions:** The conditions for a daisy chain application are as follows:

1. The master scanner's trigger must be **Serial** or **External**; the secondary scanners' triggers are configured for **Serial**.
2. All scanners are enabled to **Daisy Chain** mode.
3. Each scanner's auxiliary port must be connected to the Host port of its secondary scanner.
4. Each secondary scanner in the daisy chain must be set to send its data no less than **20**mS before its preceding scanner.
5. All but the master scanner must have **Postamble** enabled and set to **CR** (^M) only.
6. All but the master scanner must have their noread messages disabled.
7. If **Multisymbol** is enabled, **Multisymbol Separator** characters must match in all scanners and **Number of Symbols** must be set to number large enough to include all the symbols it may itself read plus the number of symbols that it will be expected to relay to the host or the next scanner up the line.
8. **Symbology ID** enable/disable must be the same in all scanners.
9. All but the master scanner must have their diagnostic warning messages disabled.
10. **Daisy Chain ID Status** enable/disable and the number of characters in **Daisy Chain ID** must be the same in all scanners.

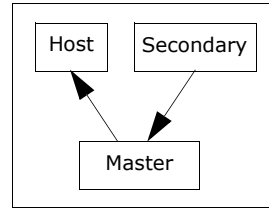

---

## Daisy Chain ID

**Usage:** Used in a daisy chain setup in cases where the host needs to know which scanner sent the data.

**Definition:** A one or two character prefix which identifies the particular daisy chain scanner from which the data is being sent.

**Serial Cmd:** <**K101**,aux port mode,baud rate,parity,stop bits,data bits,daisy chain ID status,**daisy chain ID**>

**Default:** **1/**

**Options:** Any one or two ASCII characters.

# Preamble

## *Preamble Status*

---

- Usage:** Used for identifying and controlling incoming data. For example, defining the **preamble** as a carriage return and a line feed causes each decoded message to be displayed on its own line.
- Definition:** Up to four user defined ASCII characters, including control characters, can be defined and added to the front or end of the data string that is sent from the scanner to the host.
- Serial Cmd:** `<K141,status,preamble character(s)>`
- Default:** **Disabled**
- Options:** 0 = Disabled  
1 = Enabled (within any protocol)

## *Preamble Character(s)*

---

- Serial Cmd:** `<K141,status,preamble character(s)>`
- Default:** **^M** corresponds to: **carriage return/null/null/null**.
- Options:** Up to four user-defined ASCII characters, including control characters.

### *Within a Serial Command*

To enter control characters within a serial command, hold down the control key while typing the desired character.

Example: `<KCNTL-m>` to enter **^M**

### *Within an Embedded Menu*

Control characters entered on the command line are displayed in the menu as mnemonic characters, such as: `<CR><NUL><NUL><NUL>`.

To enter a control character from within an embedded menu, first type in a space (with the space key). This has the effect of allowing the control key to be recognized as a part of the control character. Next hold down the control key while typing the desired character.

Example: `Space CNTL-m` to enter **^M**.

# Postamble

## *Postamble Status*

---

- Usage:** Used for identifying and controlling incoming data. For example, defining the postamble as a carriage return and a line feed causes each decoded message to be displayed on its own line.
- Definition:** Defines a one- to four-character data string that can be added to the end of the decoded data.
- Serial Cmd:** **<K142,status,postamble character(s)>**
- Default:** **Enabled**
- Options:** 0 = Disabled      1 = Enabled

## *Postamble Character(s)*

---

- Serial Cmd:** **<K142,status,postamble character(s)>**
- Default:** **^M^J**. Corresponds to carriage return/line feed/null/null, as displayed in the menu.
- Options:** Up to four user-defined ASCII characters, including control characters.

### *Within a Serial Command*

To enter control characters within a serial command, hold down the control key while typing the desired character.

Example: **<K,CNTL-m CNTL-j>** to enter ^M^J.

### *Within an Embedded Menu*

Control characters entered on the command line are displayed in the menu as mnemonic characters, such as: <CR><LF><NUL><NUL>

To enter a control character from within an embedded menu, first type in a space (with the space key). This has the effect of allowing the control key to be recognized as a part of the control character. Next hold down the control key while typing the desired character.

Example: **Space CNTL-m Space CNTL-j** to enter ^M^J.

## LRC Status

(Longitudinal Redundancy Check)

*Usage:* Used when extra data integrity is required.

*Definition:* An error-checking routine that verifies the accuracy of transmissions. It is the exclusive OR of all characters following the **STX** (start of text) up to and including the **ETX** (end of text). What this means is that the binary representation of all the characters in a transmissions are cumulatively added in a column and each resulting odd integer is assigned a 1 and each even integer a 0 (two 1s = 0, two 0s = 0, a 1 and a 0 = 1). The extra **LRC** character is then appended to the transmission and the receiver (usually the host) performs the same addition and compares the results.

*Serial Cmd:* <**K145**,status>

*Default:* **Disabled**

*Options:* 0 = Disabled      1 = Enabled

## Response Timeout

- Usage:* Used only when a response is required from the host. While in **Multi-drop**, if the scanner does not receive an **ACK** or **NAK** from the host after sending polled data, it will act on a fault. The scanner can be set to wait indefinitely by setting **Response Timeout** to zero.
- Definition:* Time the scanner will wait before timing out if **ACK**, **NAK**, and **ETX** are enabled, and a host response is expected.
- Serial Cmd:* <**K143**,response timeout>
- Default:* **2** (x 10 = 20 mS)
- Options:* 0 to 255 in 10mS increments (0 to 2.55 seconds)  
(A zero (0) setting causes an indefinite wait.)

## Intercharacter Delay

- Usage:* Used only when a host cannot receive data quickly enough and there is enough time between symbols to allow data to be completely transferred. It is rarely used since any setting other than zero will slow down communications. For example, a 200 setting will result in a 1/5 second delay between each character that is transmitted.
- Definition:* The time interval in milliseconds between individual characters transmitted from the scanner to the host.
- Serial Cmd:* <**K144**,intercharacter delay>
- Default:* **0**
- Options:* 0 to 255 (in milliseconds). Zero (0) causes no delay between characters.



# Chapter

# 4

# Read Cycle

## Chapter Contents

Read Cycle by ESP .....	4-2
Read Cycle by Serial Command .....	4-3
Multisymbol .....	4-4
Trigger .....	4-6
Serial Trigger .....	4-12
End of Read Cycle .....	4-13
Good Decode Reads .....	4-16
Scanner Setup .....	4-17
Laser Setup .....	4-20

Read cycles and triggering modes are at the heart of bar code scanning. After you've established communications and completed basic read rate testing, you will need to address the spatial and timing parameters associated with your application. In a typical operation a bar coded item moves along a line past a scanner. A sensor or timer activates a read cycle during which the scanner actively searches for bar code symbols. You will need to decide how to initiate the read cycle and how and when to end it. This section addresses these issues.

**Note:** When assigning characters in user-defined fields, the characters **NULL <>** and **,** can only be entered through embedded menus, not through ESP or serial commands.

# Read Cycle by ESP

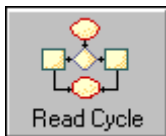

Click this Button to bring up the **Read Cycle** menu.

To change a setting, **double-click** the setting and use your cursor to scroll through the options.

To open nested options, **single-click** the +.

Parameters	ESP Values
[-] Read Cycle	
[+] Multisymbol	
[-] Trigger	
... Mode	Continuous Read
... Trigger Filter Duration	320
... External Trigger State	Active Closed
... Serial Trigger	GS
[-] End of Read Cycle	
... Mode	Timeout
... Read Cycle Timeout	100
... Good Decode Reads	1
[+] Scanner Setup	
[-] Laser Setup	
... Laser On/Off	Enabled
... Laser Framing Status	Disabled
... Laser Off Time	0
... Laser On Time	500

## Read Cycle by Serial Command

Command Title	Legacy cmds	Format
Multisymbol	<b>KL</b>	< <b>K222</b> ,number of symbols,multisymbol separator>
Trigger Mode	<b>Kg</b>	< <b>K200</b> ,trigger mode,trigger filter duration>
External Trigger State	<b>Kj</b>	< <b>K202</b> ,external trigger state>
End of Read Cycle	<b>Kh</b>	< <b>K220</b> ,end of read cycle mode,read cycle timeout>
Serial Trigger Character	<b>Ki</b>	< <b>K201</b> ,character>
Good Decode Reads	<b>Km</b>	< <b>K221</b> ,good decode reads>
Gain/Tracking	<b>KD</b>	< <b>K504</b> ,gain,tracking>
Automatic Gain Control	<b>KD</b>	< <b>K504</b> ,gain,AGC sampling mode,AGC min,AGC max>
Scan Speed		< <b>K500</b> ,scan speed>
Automatic Gain Control	<b>KH</b>	< <b>K505</b> ,AGC sampling mode,transition counter>
Video Settings	<b>KI</b>	< <b>K502</b> ,maximum element,video filter time,minimum symbol transitions>

# Multisymbol

**Usage:** Commonly used in shipping applications where a shipping symbol contains individual symbols for part number, quantity, etc. This feature allows one trigger to pick up all the symbols. AIAG and EAN-128 are two application standards that address this need.

**Definition:** **Multisymbol** allows the user to define up to 12 bar code symbols that can be read in a single read cycle.

## Number of Symbols

**Definition:** **Number of Symbols** is the number of different symbols that can be read in a single read cycle.

**Serial Cmd:** <K222,number of symbols,multisymbol separator>

**Default:** 1

**Options:** 1 to 12

## Multisymbol Separator

**Usage:** Used to delimit or separate data fields with a user defined character.

**Definition:** The character that's inserted between each symbol scanned when **Multisymbol** is set to any number greater than 1.

**ESP:** To select a new multisymbol separator, double-click on **Separator** and select a character in the popup window.

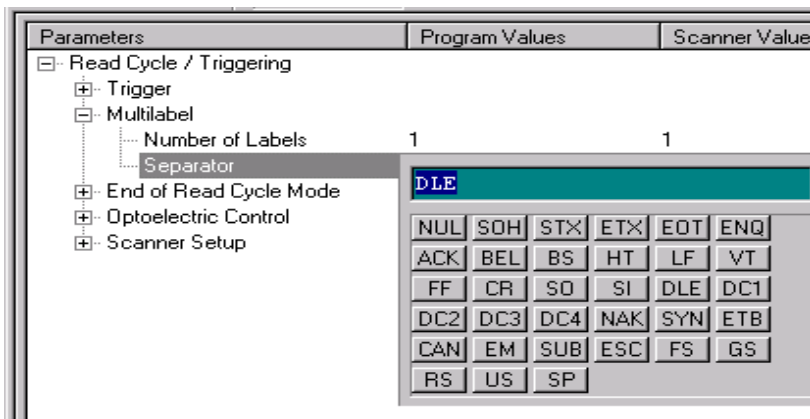

*Serial Cmd:* <**K222**,number of symbols,**multisymbol separator**>

**Note:** If **Multisymbol Separator** has been changed to any character other than the default comma and you wish to re-define the separator as a comma, use ESP (as shown below) or the embedded menu.

*Default:* , (comma)

*Options:* Any available ASCII character, except < > **NUL**.

# Trigger

## Trigger Mode

---

**Note:** When doing calibration or read rate testing, the current trigger setting will be disregarded.

**Note:** This command does not need to be followed by an <A> command.

*Definition:* The type of trigger event that will initiate the read cycle.

*Serial Cmd:* <K200,trigger mode,trigger filter duration>

*Default:* **Continuous Read**

*Options:*

0 = Continuous Read	3 = External Edge
1 = Continuous Read 1 Output	4 = Serial Data
2 = External Level	5 = Serial Data & Edge

## Continuous Read

*Usage:* Useful in testing bar code symbol readability or scanner functions. It is not recommended for normal operations.

*Definition:* In **Continuous Read**, trigger input options are disabled, the scanner is always in the read cycle, and it will attempt to decode and transmit every scan crossing a symbol.

**When To Output** and **Noread** options have no affect on **Continuous Read**.

*Serial Cmd:* <K200,0>

## Continuous Read 1 Output

*Usage:* Can be useful in applications where it is not feasible to use a trigger and all succeeding symbols contain different information. It is also effective in applications where the objects are hand-presented.

*Definition:* In **Continuous Read 1 Output** the scanner self-triggers whenever it decodes a new bar code symbol or a timeout occurs.

If **End Of Read Cycle** is set to **Timeout** and the symbol doesn't change, the scanner will repeat the output at the end of each timeout period. For example, if **Timeout** is set to one second, the scanner sends the symbol data immediately and repeats the output at intervals of one second for as long as the symbol continues to be scanned.

If **End Of Read Cycle** is set to **New Trigger**, the scanner will send the current symbol data immediately, but send it only once. A new symbol appearing in the scanner's range will be read and sent immediately provided it is not identical to the previous symbol read.

*Serial Cmd:* <**K200,1**>

**Caution:** In automated environments, **Continuous Read 1 Output** is not recommended because there is no one to verify that a symbol was missed.

**Note:** If **Trigger** is set to **Continuous Read 1 Output**, **Number of Symbols** will default back to **1** (if set to any number greater than 1).

## External Trigger Level

**Usage:** This mode is effective in an application where the speeds of the conveying apparatus are variable and the time the scanner spends scanning each object is not predictable. It also allows the user to determine if a no-read has occurred.

**Definition:** **External Trigger Level** allows the read cycle (active state) to begin when a trigger (change of state) from an external sensing device is received. The read cycle endures until the object moves out of the sensor range and the active trigger state changes again.

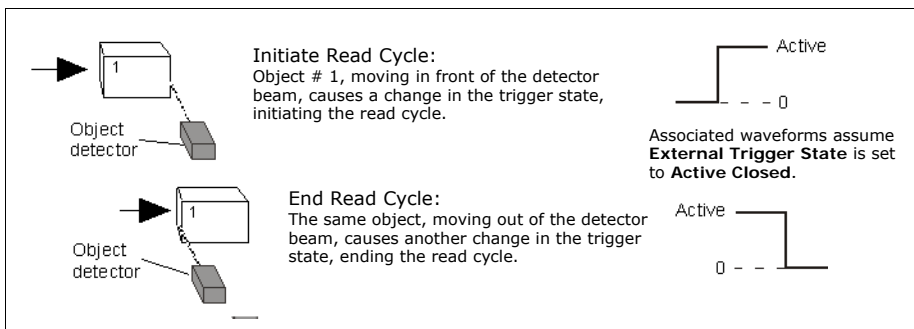

Figure 4-1 Trigger Level

**Serial Cmd:** <K200,2>

**Important:** **Level** and **Edge** apply to the active logic state (Active Open or Active Closed) that exists while the object is in a read cycle, between the rising edge and falling edge. *Rising edge* is the trigger signal associated with the appearance of an object. *Falling edge* is the trigger signal associated with the subsequent disappearance of the object.



## External Trigger Edge

**Usage:** Highly recommended in any application where conveying speed is constant or if spacing, object size, or timeouts are consistent.

**Definition:** **External Trigger Edge**, as with **Level**, allows the read cycle (active state) to begin when a trigger (change of state) from an external sensing device is received. However, the passing of an object out of sensor range does not end the read cycle. The read cycle ends with a good readoutput or, depending on **End of Read Cycle** setting, a timeout or new trigger occurs.

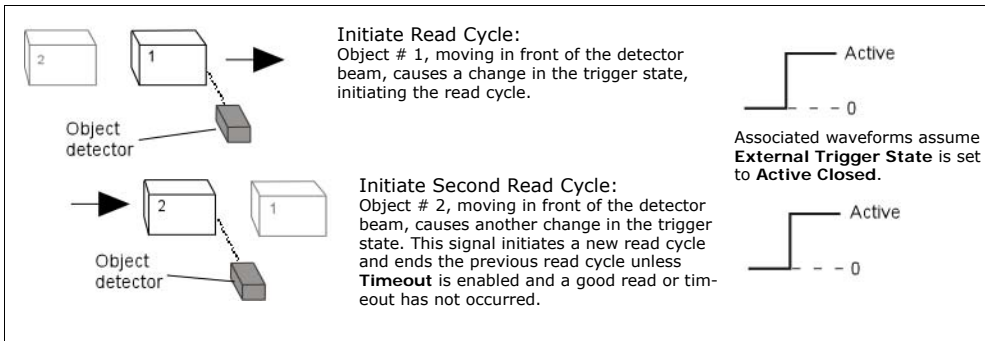

Figure 4-2 Trigger Edge

**Serial Cmd:** <K200,3>

**Important:** **Level** and **Edge** apply to the active logic state (**Active Open** or **Active Closed**) that exists while the object is in a read cycle, between the rising edge and falling edge. *Rising edge* is the trigger signal associated with the appearance of an object. *Falling edge* is the trigger signal associated with the subsequent disappearance of the object.

---

## Trigger

### Serial Data

*Usage:* Effective in a highly controlled environment where the host knows precisely when the object is in the scan zone. It is also useful in determining if a noread has occurred.

*Definition:* In **Serial Data**, the scanner accepts an ASCII character from the host or controlling device as a trigger to start a read cycle. A **Serial Data** trigger behaves the same as an **External Edge** trigger.

Serial commands are entered inside corner brackets, such as <t>.

*Serial Cmd:* <K200,4>

### Serial Data or Edge

*Usage:* **Serial Data or Edge** is seldom used but can be useful in an application that primarily uses an external sensing device but occasionally needs to be manually triggered.

An auxiliary terminal can be connected to the aux port so the user can send the serial trigger character through the scanner to the host.

*Definition:* In this mode the scanner accepts either a serial ASCII character or an external trigger pulse to start the read cycle.

*Serial Cmd:* <K200,5>



## Serial Trigger

*Usage:* Allows the user to define the trigger character that initiates the read cycle.

*Definition:* An on-line host command composed of a single ASCII host serial trigger character that initiates or ends the read cycle.

**Serial Trigger Character** is considered an on-line host command and requires the same command format as all host commands: that is, to be entered within angle brackets delimiters `< >`.

**Note:** **Serial Data** or **Serial Data & Edge** triggering mode must be enabled for Serial Trigger Character to take effect.

## End of Read Cycle

**Note:** When to Output must be set to **End of Read Cycle** before this command can be active.

*Definition:* The read cycle is the time during which the scanner will attempt to read and decode a symbol. At the end of a read cycle the scanner stops reading symbols and sends the symbol data or noread message to the host.

### *End of Read Cycle Mode*

*Definition:* A read cycle can be terminated by a new trigger, a timeout, or a combination of both.

*Serial Cmd:* <**K220,end of read cycle mode,read cycle timeout**>

*Default:* **Timeout**

*Options:* 0 = Timeout  
1 = New Trigger  
2 = Timeout & New Trigger

**Note:** When operating in **Continuous Read** or **Continuous Read 1 Output**, the scanner is always in the read cycle.

### Timeout

*Usage:* Typically used with **Serial** or **Edge** and **Continuous One**.

It is effective in highly controlled applications when the maximum length of time between objects can be predicted. It assures that a read cycle ends before the next bar coded object appears, giving the system extra time to decode and transmit the data to the host.

*Definition:* **Timeout** ends the read cycle when the time set in **Timeout** elapses or "times out."

If in **Continuous Read 1 Output**, a timeout initiates a new read cycle and allows the same symbol to be read again.

With either **External Edge**, **Serial Data**, or **Serial Data & Edge** enabled, a timeout ends the read cycle and symbol data or a noread message is sent to the host.

With **External Level** enabled, the read cycle does not end until the falling edge trigger or a timeout occurs. The next read cycle does not begin until the next rising edge trigger.

### New Trigger

*Usage:* **New Trigger** is an effective way to end a read cycle when objects move past the scanner at irregular intervals (not timing dependent).

---

## End of Read Cycle

*Definition:* **New Trigger** ends the current read cycle and initiates a new one when a new trigger occurs. **New Trigger** refers only to a “rising edge” trigger. With either **External Edge**, **Serial**, or **Serial or Edge** enabled, an edge or serial trigger ends a read cycle and initiates the next read cycle. In the case of **External Level**, a falling edge trigger ends the read cycle but the next read cycle does not begin until the occurrence of the next rising edge trigger.  
(See [Figure 4-1 on page 4-8](#) and [Figure 4-2 on page 4-9](#).)

**Note:** When **New Trigger** is enabled and if not in **External Level** mode, **Laser On/Off** will have no effect. When noreads occur, the laser will remain on.

## Timeout or New Trigger

*Usage:* Used in applications that require an alternative way to end the read cycle. For example, if an assembly line should stop completely or the intervals between objects are highly irregular.

*Definition:* **Timeout or New Trigger** is identical to **Timeout**, except that a timeout or a new trigger (whichever occurs first) ends the read cycle.

---

## Read Cycle Timeout

---

**Usage:** It is useful in many tightly controlled applications which require a read cycle to end before the next object appears and therefore need the flexibility of a timeout adjustment.

**Definition:** **Read Cycle Timeout** is the time span of the read cycle and is represented in 10 mS increments. It is used in conjunction with **External Edge** or **Serial Trigger**.

**Serial Cmd:** <**K220**,end of read cycle mode,**read cycle timeout**>

**Default:** **100** (Corresponds to one second or 1000 mS)

**Options:** 0 to 65535. (Divide any positive number entered by 100 to determine the time in seconds.)

**Timeout** does not function when in **Continuous** or **Level** read cycle modes.

**Note:** A minimum setting of **2** is recommended.

**Continuous 1:** The scanner will only read a given symbol once until a timeout occurs or a different symbol is presented.

**Note:** **Timeout** or **Timeout or New Trigger** under **End of Read Cycle** must be enabled for **Timeout Duration** to take effect.

## Good Decode Reads

*Usage:* This is a very useful feature to increase reliability of reads for symbolologies that do not have internal error checking such as Pharmacode.

*Definition:* The number of decodes (from 1 to 31) required per symbol before a symbol's decoded data is sent. It requires the scanner to successfully decode a symbol a designated number of times (not necessarily consecutively) before it is sent. If it doesn't achieve the number of good reads during the read cycle, then a noread will be sent.

**Note:** Higher settings will decrease throughput speed.

*Serial Cmd:* <**K221, good decode reads**>

*Default:* **1**

*Options:* 1 to 31

**Note:** When setting up, be sure to determine if the scanner's scan rate is capable of scanning your longest symbol the required number of times.



## Scanner Setup

The settings in this section are typically adjusted by qualified technicians. They time are included here for special applications. Before making changes to individual commands in this section, it would be advisable to make a written record of current settings.

### *Gain Level*

---

(Factory Setting)

*Usage:* Can be useful for fine-tuning gain or when portions of analog signals spike as in the case of specular reflection or extraneous noise.

**Caution:** Changes to **Gain** are typically done i.

*Definition:* Sets a voltage amplitude value for the analog circuitry.

*Serial Cmd:* <**K504,gain level,tracking**>

*Default:* **30** (nominal). Gain is optimized at the factory before shipment; the default value may not be 30.

*Options:* 0 to 255

## Automatic Gain Control (AGC)

---

**Important:** AGC settings apply to both AGC gain control and symbol detection.

### AGC Status

*Usage:* **AGC** allows the user to specify how automatic gain control sampling will be done.

*Definition:* AGC is the acronym for Automatic Gain Control. AGC increases the depth of field by attempting to maintain signal strength at a constant level regardless of the range of the bar code symbol.

*Serial Cmd:* <**K505,AGC status,transition counter**>

*Default:* **Enabled**

*Options:* 0 = Disabled      1 = Enabled

### Transition Counter

*Usage:* Can be useful in certain application where extraneous objects in the field of view might require a higher threshold.

*Definition:* Determines the number of bar/space transitions that are sampled before AGC can be resolved.

*Serial Cmd:* <**K505,AGC Status,transition counter**>

*Default:* **14**

*Options:* 10 to 255

## Video Settings

“Video” in this context, refers to the distinction of light and dark bars that go into qualifying an object as a symbol. Typically, the default settings will not need to be changed and if so required, should be done by qualified technicians.

### Maximum Element

*Usage:* **Caution:** Do not change this parameter unless instructed by a Microscan representative.

*Definition:* Maximum Element represents the maximum bar element width that’s allowed, as measured in micro seconds, before a video reset occurs (default to white).

*Serial Cmd:* <**K502,maximum element**,video filter time,minimum symbol transitions>

*Default:* **410** (x 4 $\mu$ S)

*Options:* 1 to 65535

### Video Filter Time

*Usage:* Can be useful in improving read rates for certain symbols.

**Caution:** Do not change this parameter unless instructed by a Microscan representative.

*Definition:* Bar and space filter value, in nanoseconds. If a bar or space is less than the video filter value set, then the bar or space element will be filtered out.

*Serial Cmd:* <**K502,maximum element**,**video filter time**,minimum symbol transitions>

*Default:* **12** (x 30.5nS)

*Options:* 1 to 65535

### Minimum Symbol Transitions

*Usage:* Can be useful in adjusting the threshold for qualification of certain symbols.

*Definition:* Defines the minimum number of symbol bar transitions at which a symbol is qualified as a symbol.

*Serial Cmd:* <**K502,maximum element**,video filter time,**minimum symbol transitions**>

*Default:* **12** (x 30.5nS)

*Options:* 1 to 65535

# Laser Setup

See [Chapter 10, “Laser Control”](#) for detailed list of commands and controls.

# Chapter

# 5

# Symbologies

## Chapter Contents

Symbologies by ESP .....	5-2
Symbologies by Serial Command .....	5-3
OMR .....	5-4
Code 39 .....	5-4
Code 128 .....	5-7
Interleaved 2 of 5 .....	5-8
Codabar .....	5-11
UPC/EAN .....	5-14
Code 93 .....	5-17
RSS Expanded .....	5-18
RSS Limited .....	5-19
RSS-14 .....	5-20
Narrow Margins .....	5-21
Symbology ID .....	5-22
Background Color .....	5-23
Autodiscriminate .....	5-24

This section describes the various symbol types that can be read and decoded by the scanner.

**Code 39** is enabled by default. To enable all codes, right-click **Autodiscrimination** under **Symbol Type** in the **Utilities** menu and select **Enable**, or send a **<P>** serial command to the scanner from the Terminal window.<sup>1</sup>

**Note:** When assigning characters in user-defined fields, the characters **NULL <>** and **,** can only be entered through embedded menus, not through ESP or serial commands.

See [www.aimusa.org/standards](http://www.aimusa.org/standards) for additional information about symbologies.

1. If using an I 2/5 symbol, verify that the number of characters in the symbol being scanned matches the symbol length enabled for the I 2/5 symbology type (default is 10 and 6).

# Symbologies by ESP



**Click** this button to bring up the **Symbologies** menu.

To open nested options, **single-click** the +.

To change a setting, **double-click** the setting and use your cursor to scroll through the options.

Parameters	ESP Values
[-] Symbologies	
[-] OMR Settings	
[+] OMR	Disabled
[+] Calibrated Data	
[+] Code 39	Enabled
[+] Code 128	Disabled
[+] Interleaved 2 of 5	Disabled
[+] Codabar	Disabled
[+] UPC/EAN	Disabled
[+] Code 93	Disabled
Narrow Margin Status	Disabled
Symbology Identifier	Disabled
Background Color	White

# Symbologies by Serial Command

Command Title	Legacy cmds	Format
Code 39	<b>Kp</b>	< <b>K470</b> ,status,check digit status,check digit output status,large intercharacter gap,fixed symbol length status,fixed symbol length,full ASCII set>
Code 128/EAN-128	<b>Kt</b>	< <b>K474</b> ,status,fixed symbol length status,fixed symbol length,EAN-128 status,output format,application record separator status,application record separator character,application record brackets,application record padding>
Interleaved 2 of 5	<b>Kr</b>	< <b>K472</b> ,status,check digit status,check digit output,symbol length #1,symbol length #2,guard bar>
Codabar	<b>Kq</b>	< <b>K471</b> ,status,start & stop match,start & stop output,large intercharacter gap,fixed symbol length status,fixed symbol length,check digit type,check digit output>
UPC/EAN	<b>Ks</b>	< <b>K473</b> ,UPCstatus,EAN status,supplementals status,separator status,separator char,supplemental type>
Code 93	<b>K!</b>	< <b>K475</b> ,status,fixed symbol length status,fixed symbol length>
Pharmacode		< <b>K477</b> ,status,fixed symbol length status,fixed symbol length,min. no. of bars,bar widths,fwd/rev>
PDF417	<b>K[</b>	< <b>K476</b> ,status,raster sweeps before decode attempt,fixed symbol length status,fixed symbol length>
Narrow Margins/Symbology ID	<b>Ko</b>	< <b>K450</b> ,narrow margins status,symbology identifier>
Background Color	<b>Kx</b>	< <b>K451</b> ,background color>

## OMR

---

See [Chapter 7, "OMR"](#) for OMR related commands and explanations.

### Code 39

---

**Usage:** **Code 39** is considered the standard for non-retail symbology.

**Definition:** An alphanumeric symbol with unique start/stop patterns, composed of 9 black and white elements per character, of which 3 are wide.

### Code 39 Status

**Serial Cmd:** *<K470,status,check digit status,check digit output status,large inter-character gap,fixed symbol length status,fixed symbol length,full ASCII set>*

**Default:** **Enabled**

**Note:** This is the only symbol type enabled by default.

**Options:** 0 = Disabled      1 = Enabled

### Check Digit Status (Code 39)

**Serial Cmd:** *<K470,status,check digit status,check digit output,large intercharacter gap,fixed symbol length status,fixed symbol length,full ASCII set>*

**Default:** **Disabled**

**Options:** 0 = Disabled      1 = Enabled

### Check Digit Output Status (Code 39)

**Usage:** **Check digit Output**, added to the symbol, provides additional security.

**Definition:** When enabled, the check digit character is read and compared along with the symbol data. When disabled, symbol data is sent without the check digit.

**Note:** With **Check Digit Output** and an **External** or **Serial** trigger option enabled, an invalid check digit calculation will cause a noread message to be transmitted at the end of the read cycle.

**Serial Cmd:** *<Kstatus,check digit status,check digit output,large intercharacter gap,fixed symbol length status,fixed symbol length,full ASCII set>*

**Default:** **Disabled**

**Options:** 0 = Disabled      1 = Enabled



## Large Intercharacter Gap (Code 39)

- Usage:** **Large Intercharacter Gap** is helpful for reading symbols that are printed out of specification.
- Caution:** Do not use **Large Intercharacter Gap** with **Narrow Margins** enabled since a large intercharacter gap (over 3x) could cause a narrow margins (5x) to be interpreted as an intercharacter gap.
- Definition:** When enabled, the scanner can read symbols with gaps between symbol characters that exceed three times (3x) the narrow element width.
- Serial Cmd:** `<K470,status,check digit status,check digit output,large intercharacter gap,fixed symbol length status,fixed symbol length,full ASCII set>`
- Default:** **Disabled**
- Options:** 0 = Disabled      1 = Enabled

## Fixed Symbol Length Status (Code 39)

- Definition:** When enabled, the scanner will check the symbol length against the symbol length field. If disabled, any length would be considered a valid symbol.
- Serial Cmd:** `<K470,status,check digit status,check digit output,large intercharacter gap,fixed symbol length status,fixed symbol length,full ASCII set>`
- Default:** **Disabled**
- Options:** 0 = Disabled      1 = Enabled

## Symbol Length (Code 39)

- Usage:** **Fixed Symbol Length** helps prevent truncations and increases data integrity by ensuring that only one symbol length will be accepted.
- Definition:** Specifies the exact number of characters that the scanner will recognize (this does not include start and stop and check digit characters). The scanner ignores any symbol not having the specified length.
- Serial Cmd:** `<K470,status,check digit status,check digit output,large intercharacter gap,fixed symbol length status,fixed symbol length,full ASCII set>`
- Default:** **10**
- Options:** 1 to 64

**Important:** When setting **Symbol Length** to any number other than 0, add **1** to account for a check digit. For example, if your symbol has **3** characters, set **Symbol Length** to **4**.

## Full ASCII Set (Code 39)

*Usage:* Must be enabled when reading characters outside the standard character set (0-9, A-Z, etc.)

User must know in advance whether or not to use **Full ASCII Set** option. Since **Full ASCII Set** requires two code words to encode one character, it is less efficient.

*Definition:* Standard Code 39 encodes 43 characters; zero through nine, capital "A" through capital "Z", minus symbol, plus symbol, forward slash, space, decimal point, dollar sign and percent symbol. When **Full ASCII Set** is enabled, the scanner can read the full ASCII character set, from 0 to 255.

*Serial Cmd:* **<K470,status,check digit status,check digit output,large intercharacter gap,fixed symbol length status,fixed symbol length,full ASCII set>**

*Default:* **Disabled**

*Options:* 0 = Disabled      1 = Enabled

## Code 128

- Usage:** **Code 128** is a smaller symbology useful in applications with tight spots and high security needs.
- Definition:** A very dense alphanumeric symbology. It encodes all 128 ASCII characters; it is continuous, has variable length, and uses multiple element widths measured edge to edge.

### Code 128 Status

- Serial Cmd:** <**K474,status,fixed symbol length status,fixed symbol length**>
- Default:** **Disabled**
- Options:** 0 = Disabled      1 = Enabled

### Fixed Symbol Length Status (Code 128)

- Definition:** When enabled the scanner will check the symbol length against the symbol length field. When disabled any length would be considered a valid symbol.
- Serial Cmd:** <**K474,status,fixed symbol length status,fixed symbol length**>
- Default:** **Disabled**
- Options:** 0 = Disabled      1 = Enabled

### Symbol Length (Code 128)

- Usage:** **Fixed Symbol Length** helps prevent truncations and increases data integrity by ensuring that only one symbol length will be accepted.
- Definition:** Specifies the exact number of characters that the scanner will recognize (this does not include start and stop and check digit characters). The scanner ignores any symbol not having the specified length.
- Serial Cmd:** <**K474,status,fixed symbol length status,fixed symbol length**>
- Default:** **10**
- Options:** 1 to 64

**Note:** **Fixed Symbol Length Status** must be enabled for **Symbol Length** to take effect.

## Interleaved 2 of 5

---

**Usage:** It is has been popular because it is the most dense symbology for printing numeric characters less than 10 characters in length; however We do not recommend this symbology for any new applications because of inherent problems such as truncation.

**Definition:** A dense, continuous, self-checking, numeric symbology. Characters are paired together so that each character has five elements, two wide and three narrow, representing numbers 0 through 9, with the bars representing the first character and the interleaved spaces representing the second character. (A check digit is highly recommended.)

**Important:** You must set **Symbol Length** in order to decode I 2/5 symbols.

### Interleaved 2 of 5 Status

**Serial Cmd:** <**K472,status,check digit status,check digit output,symbol length #1,symbol length #2**>

**Default:** **Disabled**

**Options:** 0 = Disabled      1 = Enabled

### Check Digit Status (Interleaved 2 of 5)

**Usage:** It is typically not used but can be enabled for additional security in applications where the host requires redundant check digit verification.

**Definition:** An error correcting routine in which the check digit character is added.

**Serial Cmd:** <**K472,status,check digit status,check digit output,symbol length #1,symbol length #2**>

**Default:** **Disabled**

**Options:** 0 = Disabled      1 = Enabled

### Check Digit Output Status (Interleaved 2 of 5)

**Definition:** When enabled, a check digit character is sent along with the symbol data for added data security.

**Serial Cmd:** <**K472,status,check digit status,check digit output,symbol length #1,symbol length #2**>

**Default:** **Disabled**

**Options:** 0 = Disabled      1 = Enabled

## Symbol Length #1 (Interleaved 2 of 5)

- Usage:** With I-2/5, two symbol lengths can be defined. When using only one symbol length in an application, setting **Symbol Length #2** to 0 (zero) to ensure data integrity is recommended.
- Definition:** Allows user to define the symbol length. Because I 2/5 is a continuous symbology, it is prone to substitution errors. Hence, a symbol length must be defined and a symbol must contain an even number of digits.
- Note:** If start, stop or check digits are used, they are not included in the symbol length count.
- Serial Cmd:** <K472,status,check digit status,check digit output,**symbol length #1,symbol length #2**>
- Default:** **10**
- Options:** 2 to 64, even
- Since I-2/5 characters are paired, symbol length must be set to an even number. If **Check Digit** is enabled, add 2 to your symbol length. For example, if your symbol is 10 characters plus a check digit, then enable **Symbol Length** for 12.
- Note:** Typically, when printing an I 2/5 symbol with an odd number of digits, a 0 will be added as the first character.

## Symbol Length #2 (Interleaved 2 of 5)

- Usage:** If using a second symbol, a zero or any even symbol length from 2 to 64 may be specified. If not using a second symbol, set **Symbol Length #2** to 0 to ensure data integrity.
- Definition:** Allows user to define a second symbol length for I-2 of 5.
- Serial Cmd:** <K472,status,check digit status,check digit output,symbol length #1,**symbol length #2**>
- Default:** **6**
- Options:** 2 to 64, even
- Since I-2/5 characters are paired, symbol length must be set to an even number. If **Check Digit** is enabled, add 2 to your symbol length. For example, if your symbol is 10 characters plus a check digit, then enable **Symbol Length** for 12.
- Note:** Typically, when printing an I 2/5 symbol with an odd number of digits, a 0 will be added as the first character.
- I-2/5

## Codabar

---

**Usage:** Used in photo-finishing and library applications. Formerly used in some medical applications but not typically used in newer applications.

**Definition:** Codabar is a 16-character set (0 through 9, and the characters \$, :, /, ., +, and -) with start/stop codes and at least two distinctly different bar widths.

### Codabar Status

**Serial Cmd:** <**K471,status,start & stop match,start & stop match output,large inter-character gap,fixed symbol length status,fixed symbol length,check digit type,check digit output**>

**Default:** **Disabled**

**Options:** 0 = Disabled      1 = Enabled

### Start & Stop Match Status (Codabar)

**Usage:** Used to increase security of symbology.

**Definition:** Requires the Codabar start and stop characters (a, b, c, or d) to match before a valid read can occur.

**Serial Cmd:** <**K471,status,start & stop match,start & stop match output,large inter-character gap,fixed symbol length status,fixed symbol length,check digit type,check digit output**>

**Default:** **Enabled**

**Options:** 0 = Disabled      1 = Enabled

### Start & Stop Output Status (Codabar)

**Usage:** Used to verify matching.

**Definition:** Causes the start and stop characters to be transmitted with symbol data.

**Serial Cmd:** <**K471,status,start & stop match,start & stop match output,large intercharacter gap,fixed symbol length status,fixed symbol length,check digit type,check digit output**>

**Default:** **Enabled**

**Options:** 0 = Disabled      1 = Enabled

## Large Intercharacter Gap (Codabar)

- Usage:* It is helpful for reading symbols that are printed out of specification.
- Caution:** Do not use **Large Intercharacter Gap** with **Narrow Margins** enabled since enabling **Large Intercharacter Gap** (over 3x) could cause a narrow margins (5x) to be interpreted as an intercharacter gap.
- Definition:* Instructs the scanner to read symbols with gaps between characters exceeding three times the narrow element width.
- Serial Cmd:* <**K471**,status,start & stop match,start & stop output match,**large inter-character gap**,fixed symbol length status,fixed fixed symbol length,check digit type,check digit output>
- Default:* **Disabled**
- Options:* 0 = Disabled      1 = Enabled

## Fixed Symbol Length Status (Codabar)

- Usage:* Helps prevent truncations and increases data integrity by ensuring that only one symbol length will be accepted.
- Definition:* When enabled, the scanner will check the symbol length against the fixed symbol length field. When disabled, any length would be considered a valid symbol.
- Serial Cmd:* <**K471**,status,start & stop match,start & stop match output,**large inter-character gap**,**fixed symbol length status**,fixed symbol length,check digit type,check digit output>
- Default:* **Disabled**
- Options:* 0 = Disabled      1 = Enabled

## Symbol Length (Codabar)

- Definition:* Specifies the exact number of characters that the scanner will recognize (this does not include start and stop and check digit characters). The scanner ignores any symbol not having the specified length.
- Serial Cmd:* <**K471**,status,start & stop match,start & stop match output,**large inter-character gap**,fixed symbol length status,**fixed symbol length**,check digit type,check digit output>
- Default:* **10**
- Options:* 1 to 64

**Note:** Because of symbology limitations, setting **Symbol Length** to any number less than four will produce undetermined results.

## Check Digit Type (Codabar)

*Definition:* Allows the user to select the check digit type Codabar will use.

*Serial Cmd:* <**K471**,status,start & stop match,start & stop match output,large intercharacter gap,fixed symbol length status,fixed symbol length,**check digit type**,check digit output>

*Default:* **Disabled**

*Options:* 0 = Disabled                      2 = NW 7  
1 = Modulus 16                      3 = Both

### *Modulus 16*

Used in the photo-finishing market.

### *NW 7*

Used in Japanese markets.

## Check Digit Output Status (Codabar)

*Usage:* For additional security a check digit can be added to the symbol.

*Definition:* When enabled, the check digit character is sent along with the symbol data. When disabled, symbol data is sent without the check digit.

*Serial Cmd:* <**K471**,status,start & stop match,start & stop match output,large intercharacter gap,fixed symbol length status,fixed symbol length,check digit type,**check digit output**>

*Default:* **Disabled**

*Options:* 0 = Disabled                      1 = Enabled



## UPC/EAN

*Usage:* Used primarily in POS application in the retail industry. It is commonly used with Microscan scanners in applications in combination with **Match-code** when there is a need to verify that the right product is being placed in the right packaging.

*Definition:* UPC (Universal Product Code) is a fixed length numeric, continuous symbology. UPC can have two- or five-digit supplemental symbol data following the normal symbol. The U.P.C., Version A (U.P.C., A) symbol is used to encode a 12 digit number. The first digit is the number system character, the next five are the manufacturer number, the next five are the product number, and the last digit is the checksum character.

When enabled, the scanner will read UPC version A and UPC version E only.

### UPC/EAN Status

*Serial Cmd:* <**K473**,**UPC status**,**UPC/EAN status**,**supplementals status**,**separator status**,**separator character**,**supplemental type**>

*Default:* **Disabled**

*Options:* 0 = Disabled            1 = Enabled

### EAN Status

**Note:** **EAN** must be enabled for **EAN** to take effect.

*Usage:* EAN is the European version of the UPC symbology and is used in European market applications.

*Definition:* EAN is a subset of UPC. When enabled, the scanner will read UPC version A, UPC version E, EAN 13, and EAN 8. It also appends a leading zero to UPC version A symbol information and transmits 13 digits. If transmitting 13 digits when reading UPC version A symbols is not desired, disable **EAN**.

**Note:** The extra character identifies the country of origin.

*Serial Cmd:* <**K473**,**UPC status**,**UPC/EAN status**,**supplementals status**, **separator status**, **separator character**,**supplemental type**>

*Default:* **Disabled**

*Options:* 0 = Disabled            1 = Enabled

## Supplementals Status (UPC/EAN)

*Usage:* Reads **Supplementals** typically used in publications and documentation.

*Definition:* A supplemental is a 2 or 5 digit symbol appended to the main symbol. When set to **Enabled** or **Required**, the scanner reads supplemental symbol data that has been appended to the standard UPC or EAN symbols.

*Serial Cmd:* <**K473**,UPC status,UPC/EAN status,**supplementals status**,separator status, separator character,supplemental type>

*Default:* **Disabled**

*Options:* 0 = Disabled            1 = Enabled            2 = Required

### *Disabled*

UPC **Supplementals** will not be decoded.

### *Enabled*

When enabled, the scanner will try to decode a main and a supplemental. However, if a supplemental is not decoded, at the end of the read cycle, the main will be sent by itself. The UPC main and supplemental symbols are considered to be one symbol and will be treated as such.

### *Required*

When set to **Required** and either the main or supplemental symbol is not read, a single noread condition results. The UPC main and supplemental symbols are treated as one symbol.

For example, if **Supplementals** is set to **Required**, **Separator** is enabled, and an asterisk is defined as the UPC separator character, then the data will be displayed as: MAIN \* SUPPLEMENTAL.

**Note:** Under no circumstances will supplemental symbol data be sent without a main symbol.

**Note:** If additional symbols—other than the main or supplemental—will be read in the same read cycle, **Number of Symbols** should be set accordingly.

## Separator Status (UPC/EAN)

*Usage:* Allows user to distinguish between the main and **Supplemental** symbols.

*Definition:* Allows the user to insert a character between the standard UPC or UPC/EAN symbologies and the supplemental symbol when **Supplementals** is set to **Enabled** or **Required**.

*Serial Cmd:* <**K473**,UPC status,UPC/EAN status,supplementals status,**separator status**,separator character,supplemental type>

*Default:* **Disabled**

*Options:* 0 = Disabled            1 = Enabled

## Separator Character (UPC/EAN)

**Note:** If Separator Character has been changed to any other character and you wish to re-define the separator as a comma, you will need to define it in the embedded menu or default the scanner by a <Zd> command.

*Usage:* As required by the application.

*Definition:* Allows the user to change the separator character from a comma to a new character.

*Serial Cmd:* <**K473**,UPC status,UPC/EAN status,supplementals status,separator status,**separator character**,supplemental type>

*Default:* , (comma)

*Options:* Any ASCII character

## *RSS Expanded*

---

*Definition:* RSS Expanded is a variable length symbology that can encode supplementary information in addition to the 14-digit EAN.UCC item identification number and is capable of encoding up to 74 numeric or 41 alphabetic characters.

*Usage:* Used to encode primary and supplementary data in retail point-of-sale and other applications.

### RSS Expanded Status

*Definition:* Offers a choice between stacked only and both stacked and not stacked.

*Usage:* Where appropriate, use 1 (non-stacked) for better performance over 2 (stacked and non-stacked).

*Serial Cmd:* <**K484**,*status*,**fixed symbol length status**,*fixed symbol length*>

*Default:* **Disabled**

*Options:* 0 = Disabled      1 = Enabled (non-stacked)

2 = Enabled (stacked and non-stacked)

### Fixed Symbol Length Status (RSS 14 expanded)

*Definition:* When enabled, the scanner will check the symbol length against the symbol length field, minus the embedded check digit. If disabled, any length would be considered a valid symbol.

*Serial Cmd:* <**K484**,*status*,**fixed symbol length status**,*fixed symbol length*>

*Default:* **Disabled**

*Options:* 0 = Disabled      1 = Enabled

### Fixed Symbol Length (RSS 14 expanded)

*Definition:* Specifies the exact number of characters that the scanner will recognize (this does not include start and stop and check digit characters). The scanner ignores any symbol not having the specified length.

*Usage:* **Fixed Symbol Length** helps prevent truncations and increases data integrity by ensuring that only one symbol length will be accepted.

*Serial Cmd:* <**K484**,*status*,**fixed symbol length status**,**fixed symbol length**>

*Default:* **10**

*Options:* 1 to 74

## *RSS Limited*

---

*Definition:* Encodes a smaller 14-digit symbol (74 modules wide) that is not omnidirectional.

*Usage:* RSS Limited is designed to be read by laser and CCD scanners. It is not recommended for omnidirectional slot scanners.

### **RSS Limited Status**

*Serial Cmd:* <**K483,status**>

*Default:* **Disabled**

*Options:* 0 = Disabled      1 = Enabled

## RSS-14

---

*Definition:* RSS-14 (Reduced Space Symbology) is a fixed length symbology that encodes 14-digits, including a 1 digit indicator digit and is 96 modules wide. It can be stacked into two rows, read omnidirectional if printed in full height, or not if height-truncated for small marking.

*Usage:* Used in the grocery retail and prescription drug industries where full 14-digit EAN.UCC item identification may be needed.

### RSS-14 Status

*Definition:* Offers a choice between stacked only and both stacked and not stacked.

*Usage:* Where appropriate, use 1 (non-stacked) for better performance over 2 (stacked and non-stacked).

*Serial Cmd:* **<K482,status>**

*Default:* **Disabled**

*Options:*

- 0 = Disabled
- 1 = Enabled (non-stacked)
- 2 = Enabled (stacked and non-stacked)

## Narrow Margins

*Usage:* Used when the leading and trailing edges of the symbols are smaller than the standard margin or when other objects encroach into the margins.

*Definition:* Allows the scanner to read symbols with quiet zones less than 8 times the width of the narrow bar element. "Quiet zone" is the space at the leading and trailing ends of a symbol. Each quiet zone can be as narrow as only five times the width of the narrow bar element when **Narrow Margins** is enabled.

*Serial Cmd:* <**K450,narrow margins status**,symbology identifier status>

*Default:* **Disabled**

*Options:* 0 = Disabled      1 = Enabled

**Note:** Do not use **Narrow Margins** with **Large Intercharacter Gap** enabled in **Code 39** or **Codabar**.

# Symbology Identifier

**Usage:** Used when the symbology type and how it's decoded needs to be known.

**Definition:** Symbology ID is an AIM standard prefix set of characters that identify the symbol type.

When enabled, the scanner analyzes and identifies the symbology and adds a three character identifying prefix to the data:

1. **]** (close bracket character) indicating the presence of a symbology ID
2. **A, C, E, I, L, Q, b, d, p**  
A = Code 39; C = Code 128; E = UPC/EAN; F = Codabar; G = Code 93; I = I-2/5
3. **Modifier** (see [Explanation of Modifiers](#) below)

**Serial Cmd:** <**K450,narrow margins,symbology identifier status**>

**Default:** **Disabled**

**Options:** 0 = Disabled      1 = Enabled

## Explanation of Modifiers for Code 39, Codabar, and I-2/5

- For **Code 39, Codabar** and **I 2/5**, the modifier indicates **Check Digit** and **Check Digit Output** status.
- For **Code 39** only, **Full ASCII** needs to be enabled to see modifiers **4, 5, and 7**.

Modifier	Check Digit	Check Digit Output	Full ASCII conversion performed (Code 39 only)
<b>0</b>	Disabled	N/A	No
<b>1</b>	Enabled	Enabled	No
<b>3</b>	Enabled	Disabled	No
<b>4</b>	Disabled	N/A	Yes
<b>5</b>	Enabled	Enabled	Yes
<b>7</b>	Enabled	Disabled	Yes

**Example:** **]A5** indicates a Code 39 symbol with **Check Digit** and **Check Digit Output** enabled and Full ASCII conversion performed.

## For Other Symbologies

- For Code 128, a **1** indicates EAN; otherwise the modifier is a **0**.
- For all other symbologies, the modifier is **0**.



## Background Color

- Usage:* If the background is darker than the symbol, then enable black background.  
Typically the background is white; but on PCBs for example, they can be black.
- Definition:* Allows the user to choose which symbol background (white or black) the scanner can read.
- Serial Cmd:* **<K451,background color>**
- Default:* **White**
- Options:* 0 = White            1 = Black

## Autodiscriminate

Although **Autodiscriminate** is not a configuration command, but it is included here as a convenient tool for enabling most symbol types.

*Usage:* Commonly used for quick setup mode to detect symbol type. This is particularly useful for users who might be unfamiliar with their application's symbology.

**Note:** It does not alter individual fields such as **Start/Stop, Fixed Length**, etc. These need to be setup individually.

*Definition:* Enables all available symbology types except PDF417, UCC/EAN 128. The user may also individually disable/enable each symbology type.

*Serial Cmd:* **<P>** Enables all symbologies except noted above

*Default:* **Code 39** (only)

*Other* <Q> Enables Code 39 only

*Options:* <R> Enables Codabar only

<S> Enables I 2/5 only

**Note:** If using an I 2/5 symbol, verify that the number of characters in the symbol being scanned matches the symbol length enabled for the I 2/5 symbol type (default is 10 and 6).

# Chapter

# 6

# Matchcode

## Chapter Contents

Matchcode by ESP Menu .....	6-2
Matchcode by Serial Command.....	6-2
Overview of Matchcode .....	6-3
Matchcode Type .....	6-4
Sequential Matching .....	6-5
Match Length .....	6-6
Sequence On Noread .....	6-7
Sequence On Mismatch .....	6-8
New Master Pin .....	6-9

This section explains the matchcode output functions and setup.

See also [“Master Database” on page 12-11](#) for more information details on using ESP for entering, requesting, and deleting master symbols.

**Note:** When assigning characters in user-defined fields, the characters **NULL <>** and **,** can only be entered through embedded menus, not through ESP or serial commands.

# Matchcode by ESP Menu



Click this button to bring up the **Matchcode** menu.

To change a setting, **double-click** the setting and use your cursor to scroll through the options.

Parameters	ESP Values
[-] Matchcode	
Matchcode Type	Disabled
Sequential Matching	Increment
Match Start Position	0
Match Length	1
Wild Card	*
Sequence on Noread	Enabled
Sequence on Mismatch	Disabled
New Master Pin	Disabled

# Matchcode by Serial Command

Command Title	Legacy cmds	Format
Matchcode Type	<b>Kn</b>	<K223,type,sequential matching,match start position,match length,wild card character,sequence on noread,sequence on mismatch>
Sequential Step		<K228,sequence step>
New Master Pin	<b>Kz</b>	<K225,status>
Master Symbol Database Size	<b>KM</b>	<K224,number of master symbols>
Optoelectric Control		<K226,mode,# active database settings,latch on trigger,timer value, control trigger 1,control trigger 2,control trigger 3>
Optoelectric Calibration Database		<K227,database index,focus position,gain,tracking>
Enter/Delete Master Symbol Data	M	<K231,master symbol number,master symbol data [no data will delete current master symbol data]>
Request Master Symbol Data	M	<K231,?>[for all] or <K231,master symbol number?>

## Overview of Matchcode

*Usage:* **Matchcode** is used in applications to sort, route, or verify data based on matching the specific symbol in a variety of ways as defined in this section. For example, a manufacturer might sort a product based on dates that are embedded in the symbol.

*Definition:* With **Matchcode** you can store master symbol data in the scanner's memory, compare this data against the scanned symbols, and define how symbol data and/or discrete signal output will be directed. A master symbol database can be set up for up to 10 master symbols. See ["Master Database" on page 12-11](#).

## Using Master Symbols

1. Set **Triggering Mode** to **External** or **Serial** (see ["Trigger" on page 4-6](#)).
2. Set **Matchcode Type** to an option that fits your application (see ["Matchcode Type" on page 6-4](#)).
3. Define the output you want with your matchcode setup:
  - a) Data output (["Symbol Data Output" on page 8-3](#)).
  - b) Discrete output (["Output 1 Parameters" on page 8-11](#)).
4. Select the number of master symbols you want to create, if more than one send a `<K224,number of master symbols>` command (see ["Master Database" on page 12-11](#)).
5. Enter master symbol data in one of the following ways:
  - a) Use **ESP** to type in master symbol data directly into the **Utilities** menu.
  - b) Send a serial command with symbol data in the form of `<Mmaster symbol#,data>` (or `<data>` for single master symbol only).
  - c) Send a `<Gmaster symbol number>` command to scan next symbol in as the master symbol.

Enable the **New Master Pin** command and activate a discrete input to store the next symbol scanned as the master symbol (see ["New Master Pin" on page 6-9](#)).

See also ["Master Database" on page 12-11](#) for more information details on using ESP for entering, requesting, and deleting master symbols.

# Matchcode Type

**Note:** If **Matchcode** is set to **Wild Card** or **Sequential**, **Number of Symbols** will default back to **1** (if set to any number greater than 1).

*Definition:* Allows the user to choose the way that master symbols will be compared with subsequently scanned symbols.

**Note:** First set **Triggering Mode** to **External** or **Serial**.

*Serial Cmd:* **<K223,matchcode type,sequential matching,match start position,match length,wild card character,sequence on noread,sequence on mismatch>**

*Default:* **Disabled**

*Options:* 0 = Disabled                      2 = Wild Card  
              1 = Enabled                     3 = Sequential

## *Options*

Has no effect on operations.

## *Enabled*

Instructs the scanner to compare symbols or portions of symbols with the master symbol.

## *Wild Card*

Allows the user to enter user defined wild card characters in the master symbol.

## *Sequential*

Instructs the scanner to sequence after each match (numeric only) and compare symbols or portions of symbols for sequential numbers.

## Sequential Matching

- Usage:* Used in tracking product serial numbers that increment or decrement sequentially.
- Definition:* With **Sequential** enabled under **Matchcode Type**, **Sequential Matching** determines if a count is in ascending (incremental) or descending (decremental) order.
- Serial Cmd:* `<K223,matchcode type,sequential matching,match start position,match length,wild card character,sequence on noread,sequence on mismatch>`
- Default:* **Increment**
- Options:* 0 = Increment    1 = Decrement

## Match Start Position

- Usage:* **Match Start Position** is useful in defining specific portions of a symbol for comparisons. For example, if a symbol contains a part number, manufacturing date, and lot code info but the user is only interested in the part number information, **Match Start Position** can be set to only sort on the part number and ignore the rest of the characters.
- Definition:* **Match Start Position** determines the portions of symbols that will be matched by defining the first character in the symbol (from left to right) that will be compared with those of the master symbol, when **Matchcode Type** is set to **Enabled** or **Sequential**.
- Example:* For example, if **Match Start Position** is set to 3, the first 2 characters read in the symbol will be ignored and only the 3rd and subsequent characters to the right will be compared, up to the number of characters specified by **Match Length**.
- Serial Cmd:* `<K223,matchcode type,sequential matching,match start position,match length,wild card character,sequence on noread,sequence on mismatch>`
- Default:* **0**
- Options:* 0 to 64

**Note:** **Match Start Position** must be set to **1** or greater to enable this feature. A **0** (zero) setting will disable this feature.

## Match Length

- Usage:* For example, if **Match Length** is set to **6** in a 10 character symbol, and **Match Start Position** is set for **2**, only the 2nd through 7th characters (from left to right) will be compared.
- Definition:* Defines the length of the character string that will be compared with that of the master symbol when **Match Start Position** is set to **1** or greater. When **Match Start Position** is set to **0**, no comparison will occur.
- Serial Cmd:* **<K223,matchcode type,sequential matching,match start position,match length,wild card character,sequence on noread,sequence on mismatch>**
- Default:* **1**
- Options:* 1 to 64

## Wild Card

- Usage:* For example, with **Wild Card** character defined as the default asterisk, defining **CR\*34** as the master symbol will result in matches for CR134, CR234, but not CR2345. Entering the wild card at the end of the master symbol as in **CR\*** will result in matches for variable symbol lengths such as CR1, CR23, CR358, etc.
- Definition:* **Wild Card** character allows a user to define a wild card character as part of the master symbol.
- Serial Cmd:* **<K223,matchcode type,sequential matching,match start position,match length,wild card character,sequence on noread,sequence on mismatch>**
- Default:* **\*** (asterisk)
- Options:* Any valid ASCII character



## Sequence On Noread

- Usage:* **Sequence On Noread** is useful when the scanner needs to stay in sequence even if no decode occurs.
- Definition:* When **Sequence On Noread** is **Enabled** and **Matchcode** is set to **Sequential**, the scanner sequences on every match or noread. When disabled, it does not sequence on a noread.
- Serial Cmd:* **<K223,matchcode type,sequential matching,match start position,match length,wild card character,sequence on noread,sequence on mismatch>**
- Default:* **Enabled**
- Options:* 0 = Disabled      1 = Enabled

When **Sequence On Noread** is enabled, the master symbol will increment by one if either a match or a noread occurs.

If both **Sequence On Noread** and **Sequence On Mismatch** are enabled, the master symbol will increment in every event (match, mismatch, or noread).

In the special case, where the expected number is missed by only 1, the sequence skips over the next number in order to resume the sequence. For example, a 002 is expected but a 003 is read. The next master symbol will be 004. See the tables under "**Sequence On Mismatch**" on page 6-8 for examples of this.

# Sequence On Mismatch

**Note:** Matchcode must be set to **Sequential** for this command to function.

**Usage:** Enable this parameter if every trigger event should have a decode *and* more than one consecutive mismatch may occur.  
Disable this parameter if every trigger event should have a decode but no more than one consecutive mismatch may occur.

**Definition:** When set to **Enabled**, the master symbol sequences on every decode, match or mismatch. When set to **Disabled**, the master symbol will not sequence whenever consecutive mismatches occur.

**Serial Cmd:** <**K223**,matchcode type,sequential matching,match start position,match length,wild card,sequence on noread,**sequence on mismatch**>

**Default:** **Disabled**

**Options:** 0 = Disabled 1 = Enabled

As an example of **Sequence On Mismatch Enabled**, consider the following decodes:<sup>1</sup>

Master Symbol	Decoded Symbol	Master After Decode	Action
001	001	002	Sequenced on match
002	abc	003	Sequenced on mismatch
003	def	004	Sequenced on mismatch
004	005	006	Sequence skipped
006	ghi	007	Sequenced on mismatch
007	007	008	Sequenced on match

As an example of **Sequence On Mismatch Disabled**, consider the following decodes:

Master Symbol	Decoded Symbol	Master After Decode	Action
001	001	002	Sequenced on match
002	abc	003	Sequenced because of previous match
003	def	003	Not sequenced
003	003	004	Sequenced on match
004	005	006	Sequence skipped
006	006	007	Sequenced on match

You can access **Master Symbol Database** operations from the **Utilities** menu.

1. In both tables, when the expected number is missed by only 1, the sequence skips over the next number in order to resume the sequence.

## New Master Pin

*Usage:* Some applications require the line worker to change the master symbol. This can be done by installing a switch at the location of the scanner. It is very common to have a keyed switch so that accidental switching does not occur.

*Definition:* After **New Master Pin** is enabled, a pulse can be received on the new master pin which will cause the scanner to record the next decoded symbol symbol(s) as the new master symbol(s).

It is important to note that the enabling **New Master Pin** does not in itself cause a master symbol to be recorded. The master pin must then be activated momentarily (for a minimum of 10 ms) before a master symbol can be scanned into memory. (See ["Electrical Specifications" on page A-5.](#))

*Serial Cmd:* <**K225,status**>

*Default:* **Disabled**

*Options:* 0 = Disabled      1 = Enabled

After **New Master Pin** has been enabled and the pin activated, decodes will be saved in the master database beginning with master symbol #1. If the scanner is configured for a multisymbol read cycle (**Number of Symbols** is greater than 1), the remaining decodes will be saved in each consecutive master symbol location. For example, if **Number of Symbols** is set to **3** and **New Master Pin** is then activated, at the end of the next read cycle, the decoded symbol symbols will be saved as master symbols 1, 2, and 3.



# Chapter

# 7

# OMR

*(Optical Mark Recognition)*

## Chapter Contents

OMR Setup by ESP Menu .....	7-2
OMR Setup by Serial Command .....	7-2
OMR Description .....	7-3
OMR Definitions .....	7-4
OMR Setup & Calibration Menu .....	7-5
OMR Setup .....	7-6
Static Test .....	7-10
Dynamic Calibration .....	7-11
Calibration Data .....	7-12
Laser Control .....	7-15

Optical Mark Recognition (OMR) is a coding symbology used by the document handling industry. Optical marks are bars printed on a document, which by their presence or absence in a pre-defined code length, contain coded machine data relevant to that document, such as a sorting procedure based on regions or zip codes.

There is no industry wide standard for OMR decoding. Each company has its own method of decoding. The MS-9 accommodates these by outputting an ASCII binary or hexadecimal representation of the OMR patterns.

The MS-9, through a unique system of calibration and precise timing, uses a high-speed moving laser beam to detect and decode moving OMR symbols.

# OMR Setup by ESP Menu

Parameters	ESP Values
[-] Symbologies	
[-] OMR Settings	
[-] OMR	Disabled
Parity	None
Number of Fields	7
Trigger Delay Type	Pulse
Number of Scans	5
Gate Bar Location	Left
Trigger Delay	0
Output Style	Binary
[-] Calibrated Data	
Calibrate Delay Status	Enabled
Auto Frame Status	Enabled
Average Bar Width	0
Average Cell Width	0
Margin	0
Scan Count	0

# OMR Setup by Serial Command

Command Title	cmds	Format
OMR Setup	<b>K490,</b>	<b>&lt;K490,status,parity status,# fields,trigger delay mode,# scans,gate bar location,trigger delay type,output style&gt;</b>
OMR Calibration	<b>KP</b>	<b>&lt;KPcalibrate delay status,auto frame status,avg bar width,avg cell width,leading margin,scan count value&gt;</b>

## OMR Description

OMR marks or “bars” are printed in the center of uniformly spaced rectangular fields which are not visible. Not all fields must contain marks. If a given cell has a mark within its boundaries, you can consider the cell to have a value of 1 (one). If the cell has no mark, it has a value of 0 (zero). With this symbology you can generate a binary number that can be used by any system to interpret the meaning of the code. The content of the code can vary from manufacturer to manufacturer, but the applications are generally very similar. A typical symbol has 8 to 32 fields and will contain encoded data relating to groups, sets, page numbers, or any combination of these. A start or “gate” mark is always present in the first cell; all remaining fields may or may not have marks present.

# OMR Definitions

**OMR.** Symbology that is composed of a series of fields (or “placeholders”) of uniform width that are either empty or contain a mark (a bar also of uniform width) in their centers. A cell with a mark is equivalent to a binary 1, an empty cell is represented by a binary 0. Typical OMR symbols contain from 8 to 32 fields.

**Gate Bar.** The first bar in the OMR symbol relates to the decoding direction.

**Cell.** (Sometimes referred to as a “field.”) The area in which a mark is present or absent. The cell is wider than the mark.

**Bar or Mark.** A bar which can be present inside a cell.

**Test Pattern.** OMR symbol used to calibrate the scanner during initial setup.

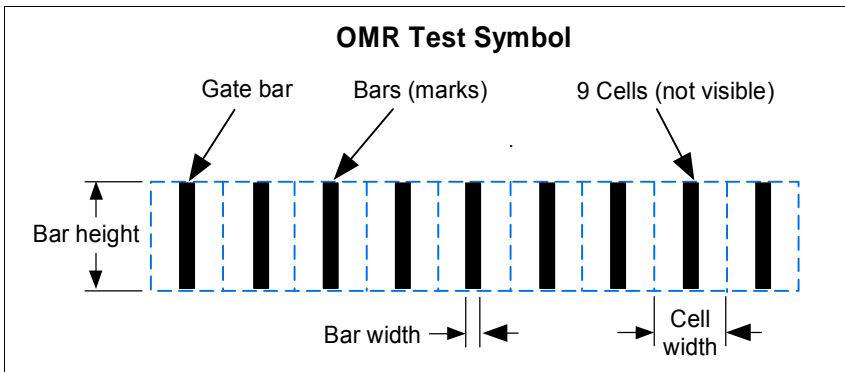

The sketch above shows a 9 cell OMR symbol with 9 bars. The dashed outline of the fields serves as a visual demonstration and is not visible when printed. The first cell always contains a gate bar which serves to locate the symbol. The last cell can contain a parity bar.



# OMR Setup & Calibration Menu



When you click on **OMR** button you will see a menu similar to that below. **Setup**, **Calibration Data**, and **Laser Control** commands can be modified in the menu tree on the left. On the right side of the menu box, you can test for **Static** or **Dynamic** setups and see **OMR Data** displayed in four text blocks. When you do a test, a representation of the symbol is displayed in front of a scanner with laser **Off Time** and laser **On Time** settings that allow you to manually center scans over a smaller area to reduce the possibility of miscellaneous “noise.”

The OMR menu shown here is an example of what you might see during an actual calibration with **OMR**, **Framing**, and **Show Output** enabled:

The screenshot displays the OMR Setup & Calibration menu interface, divided into two main sections: Parameters and Reader Values on the left, and OMR Controls on the right.

**Parameters and Reader Values:**

- OMR Settings**
  - Setup**
    - Status: Enabled
    - Parity: None
    - Number of Fields: 9
    - Trigger Delay Ty...: Time
    - Number of Scans: 5
    - Gate Bar Location: Left
    - Trigger Delay: 0
    - Output Style: Binary
  - Calibrated Data**
    - Calibrate Delay S...: Enabled
    - Auto Frame Status: Enabled
    - Average Bar Wid...: 168
    - Average Cell Wid...: 856
    - Margin: 12316
    - Scan Count: 1569
  - Laser Control**
    - Laser On/Off: Disabled
    - Laser Framing Sta...: Enabled
    - Laser Off Time: 0
    - Laser On Time: 500

**OMR Controls:**

- OMR Enabled
- Calibrate**
  - Static
  - Dynamic
  - Cancel
- Test**
  - Once
  - Continuous
  - Cancel
- OMR Data**

Margin	Bar Width	Cell Width	Good Reads
12316	168	856	1
- Gate Bar Location = Left**
  - Off Time: 0
  - Framing Enabled
  - On Time: 500
- Gate Bar Location = Right**
- Show Output
- Output Style: Binary
- 11111111

# OMR Setup

To setup the scanner for OMR testing, do the following:

1. Use a master OMR symbol with no gaps and all bars equally spaced.
1. In the **OMR Settings**, enable OMR **Status**.
2. Set **Parity** as desired.
3. Enter the number of fields (bars or cells) in the symbol, in this example, **9**.
4. Enter the number of scans in the read cycle. Five (**5**) is recommended. Too high a number may result in incomplete scans, depending on symbol speed.
5. Select **Gate Bar** location.

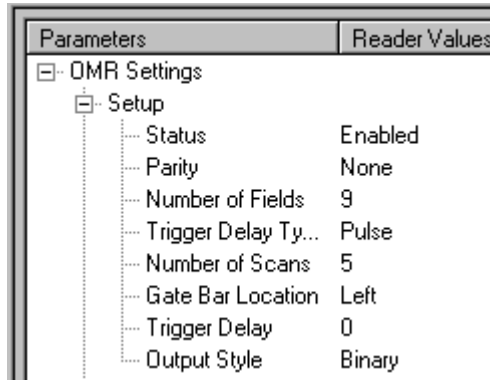

Parameters	Reader Values
[-] OMR Settings	
[-] Setup	
Status	Enabled
Parity	None
Number of Fields	9
Trigger Delay Ty...	Pulse
Number of Scans	5
Gate Bar Location	Left
Trigger Delay	0
Output Style	Binary

To save settings:

1. Right-click anywhere in the **OMR Settings** window.
2. Choose **Send, No Save** or **Send and Save**.

See individual command definitions for more information.

## OMR Status

**Definition:** When you click **Enable**, OMR Calibration menu, OMR is enabled and all other codes are disabled.

**Serial Cmd:** `<K490,status,parity status,# fields,trigger delay mode,# scans,gate bar location,trigger delay type,output style>`

**Default:** **Disabled**

---

## Parity

---

**Definition:** The last cell in the symbol (the bar furthest from the gate bar) can contain a parity bar, if enabled. If enabled for **Odd** and the number of bars is not odd, the parity bar will be added in the last cell. If enabled for **Even** and the number of bars is not even, a parity bar is added to the last cell.

**Usage:** A parity bar is added to make the count conform to its setting.

**Serial Cmd:** <**K490**,status,**parity status**,# fields,trigger delay mode,# scans,gate bar location,trigger delay type,output style>

**Default:** **None**

---

## Number of Fields

---

**Definition:** The number of fields is the number of cells in which a bar can be displayed. An OMR application typically has from 8 to 32 fields.

**Usage:** The number of fields depends on the symbols you will be scanning. It is important to set this correctly or your data will be invalid.

**Serial Cmd:** <**K490**,status,parity status,# **fields**,trigger delay mode,# scans,gate bar location,trigger delay type,output style>

**Default:** **7**

**Options:** 1 to 32

## Trigger Delay Type

---

**Definition:** If **Pulse** is enabled, the scanner will wait the number of pulses (from an encoder) set by **Trigger Delay** before evaluating its scans for OMR symbols.

With **Time** enabled, the scanner measures the time that transpires between a trigger and the appearance of a symbol in the center of the scan and applies that delay to subsequent triggers before evaluating scans for OMR symbols.

**Usage:** With **Pulse** enabled, the scanner can track OMR symbols on variable speed applications. This requires the use of both triggering and encoder pulse timing devices.

If the symbols are moving by at a fixed speed, **Time** delay can be used in connection with a triggering device alone.

**Serial Cmd:** <K490,status,parity status,# fields,trigger delay mode,# scans,gate bar location,trigger delay type,output style>

**Default:** **Pulse**

**Options:** 0 = Time                    1 = Pulse

## Number of Scans

---

**Definition:** Depending on speed and length of the symbol, the whole symbol is within the scan beam width a very specific time period. When the set number of scans is reached, the scanner compares OMR scans and outputs those scans with the most successful decodes.

**Usage:** Enabling too many scans could result in incomplete scans; too few could diminish reliability.

**Serial Cmd:** <K490,status,parity status,# fields,trigger delay mode,# scans,gate bar location,trigger delay type,output style>

**Default:** **5**

**Options:** 1 to 15

## Gate Bar Location

---

**Definition:** Allows you to select which side of the OMR symbol the scanner will interpret as a gate bar.

**Usage:** The scanner can decode symbols with gate bars on either end; however it is important to correctly identify the position of the gate bar since data sent to the host must begin with a gate bar.

**Serial Cmd:** <**K490**,status,parity status,# fields,trigger delay mode,# scans,**gate bar location**,trigger delay type,output style>

**Default:** **Left**

**Options:** 0 = Left                      1 = Right

## Trigger Delay

---

**Definition:** If **Pulse** has been enabled in **Trigger Delay Type**, the count represents the number of pulses that occur between the time a trigger is received and the scanner begins to evaluate its scans. If in **Time** mode, the delay time is represented in 8  $\mu$ S increments (a setting of 100 = 800  $\mu$ S).

With **Time** enabled, the scanner calculates the time that transpires between a trigger and the appearance of a symbol in the center of the scan. At the next trigger edge the scanner will wait the designated Trigger Delay value before the scanner begins to evaluate its scans for OMR symbols.

**Usage:** (See **Trigger Delay Type**.)

**Serial Cmd:** <**K490**,status,parity status,# fields,trigger delay mode,# scans,gate bar location,**trigger delay type**,output style>

**Default:** **0**

**Options:** 0 to 65535

## Output Style

---

**Definition:** In **Binary**, the outputs appear as 1s and 0s.  
In **Hexadecimal** they appear as ASCII characters.

**Serial Cmd:** <**K490**,status,parity status,# fields,trigger delay mode,# scans,gate bar location,trigger delay type,**output style**>

**Default:** **Binary**

**Options:** 0 = Binary                      1 = Hexadecimal

# Static Test

Whenever you start a new batch or job, you should calibrate a test symbol that is representative of the application's symbols and has a full set of bars so the scanner can calculate the symbol's average frame size, number of fields, etc. as a reference.

After doing OMR setup, position a symbol in the center of the scan range at the correct distance from the scanner. (Nominal mounting distance is 4 inches (10.6 cm) from the front of the scanner.)

## Testing from Calibration Menu

1. In the **Calibrate** area, click the **Static** button.
2. View the representation of your symbol shown in the scan on the **Calibration** menu.  
The sample pattern shown here has 9 bars in the calibration window, the first of which (at top) is a green gate bar.
3. To repeat the test, click the **Once** button under **Test**.

**Note:** If you switch symbols, always use the Once button. If you use **Static**, the scanner will attempt to re-calibrate the symbol based on the current symbol.

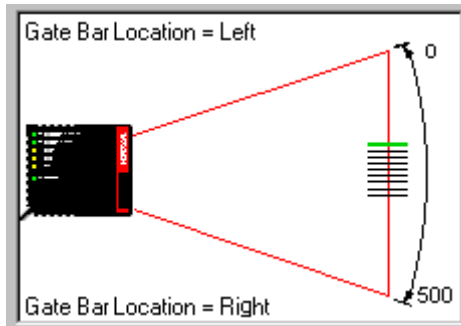

Or you can click on the **Continuous** button and see the data produced in the **OMR Data** bar.

## Testing from Terminal View



1. After static calibration is complete, click on the **Terminal** button.
2. From the macro bar at the bottom of the **Terminal** window, select, **Enable Serial Trigger**.

**Note:** You may need to click **Next Row** to locate the macro.

3. Go back to the macro bar and select **Send Trigger Character**.



You can also enable the **Continuous** macro and then the **Send Trigger Character** macro to view the results of multiple continuous triggers.

# Dynamic Calibration

To test for a moving symbol:

1. Set up an object detector or other external triggering device.
2. In the OMR Settings **Setup** menu, set the **Number Of Fields** for the symbol.
3. If the conveyor is moving at a fixed speed, under **Trigger Delay Type**, you can choose either **Time** or **Pulse**. If moving at a variable speed, enable **Pulse** (use this with an encoder with inputs into the scanner's new master pin).
4. If symbols are moving in a picket fence direction, make certain that **Auto Frame Status** in the menu tree is set to **Enabled**. This will automatically shrink the scan beam width to optimum size (represented by the red lines and arrow "handles" on the scan window in the menu). For Ladder type symbols you should disable **Auto Frame** and manually move the red arrows to bracket the symbol as the dynamic calibration is active, taking care to leave comfortable margins on both ends of the symbol.
5. Start the conveyor line.
6. In the **Calibrate** area, click **Dynamic**.

Upon receiving a trigger, the scanner will begin looking for an OMR symbol with consistent spacing between bars and a number of bars corresponding to the number of fields enabled. Once found, the scanner's setup algorithm records the time or pulses from trigger to read and uses this as a benchmark for future reads.

**Important Note:** If **Auto Frame** has been enabled, the scanner will not calibrate **Time** or **Pulse** values unless the OMR symbol is in the center of the scan.

7. Note where the scans are appearing on the OMR scan window.  
Alternately, you may manually by using the direction arrows in the **Off Time** and **On Time** boxes.
8. Click on the **TERMINAL** button to see the symbol's output. If you are in a Binary mode, you should see: 1 1 1 1 1 1 1. The reason the test pattern has a full set of bars is so that the scanner can infer the symbol's frame size.
9. Return to the OMR menu and right click on the menu to save settings.

# Calibration Data

Following a static or dynamic test, see the **OMR DATA** area to view **Margin, Bar Width, Cell Width, and Good Reads**.



OMR Data			
Margin	Bar Width	Cell Width	Good Reads
7183	162	839	1

The bottom window presents the current triggered data. This serves to give you an idea of consistency and variations.

You can also switch between **Binary** and **Hexidecimal** presentation of decoded data. See and adjust calibration parameters in the Calibrated Data section of the OMR menu.

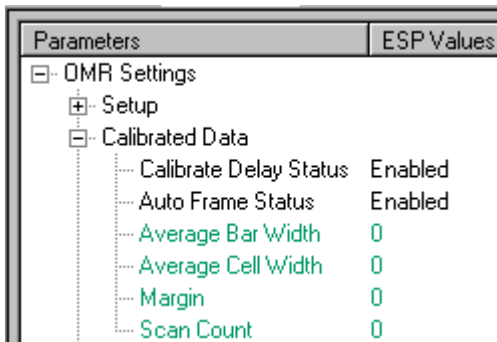

Parameters	ESP Values
[-] OMR Settings	
[+] Setup	
[-] Calibrated Data	
... Calibrate Delay Status	Enabled
... Auto Frame Status	Enabled
... Average Bar Width	0
... Average Cell Width	0
... Margin	0
... Scan Count	0

## Calibrate Delay Status

**Definition:** When **Calibrate Delay Status** is enabled, the scanner will attempt to set the delay time (or pulse) automatically.

**Usage:** This is useful if your symbols arrive at irregular times.

**Serial Cmd:** *<K**Pcalibrate delay status**,auto frame status,avg bar width,avg cell width,leading margin,scan count value>*

**Default:** **Enabled**

**Options:** 0 = Disabled      1 = Enabled



## Auto Frame Status

---

- Definition:** When **Enabled**, OMR calibration command will adjust laser framing to frame OMR calibration bar code with sufficient quite zones. When **Auto Frame** is enabled, the OMR calibration symbol must be in the center of the scan for a successful decode to occur.
- When **Disabled**, OMR calibration command will not adjust laser framing.
- Serial Cmd:** <**KP**calibrate delay status,**auto frame status**,avg bar width,avg cell width, leading margin,scan count value>
- Default:** **Enabled**
- Options:** 0 = Disabled      1 = Enabled

## Average Bar Width

---

- Definition:** Determined by OMR calibration. It represents the average value of the bar widths from calibrated OMR symbol.
- Usage:** READ ONLY.
- Serial Cmd:** <**KP**calibrate delay status,auto frame status,**avg bar width**,avg cell width, margin,scan count value>

## Average Cell Width

---

- Definition:** Determined by OMR calibration. It represents the average of the field widths from calibrated OMR symbol. Count resolution is 15.25 nS.
- Usage:** READ ONLY.
- Serial Cmd:** <**KP**calibrate delay status,auto frame status,avg bar width,**avg cell width**,leading margin,scan count value>

## Leading Margin

---

- Definition:** Determined by OMR calibration. It represents the count value from the start of the scan to the gate bar of OMR symbol. Count resolution is 15.25 nS.
- Usage:** READ ONLY.
- Serial Cmd:** <**KP**calibrate delay status,auto frame status,avg bar width,avg cell width,**leading margin**,scan count value>

## Scan Count

---

*Definition:* Determined by OMR calibration. It represents the count value from the start of the scan to the end of the scan. Count resolution is 15.25 nS.

*Usage:* READ ONLY.

*Serial Cmd:* <**KP**calibrate delay status,auto frame status,avg bar width,avg cell width,margin,**scan count value**>

# Laser Control

**Laser Control** is included as part of the OMR menu so that changes in the Laser **Off Time** and Laser **On Time** can be observed.

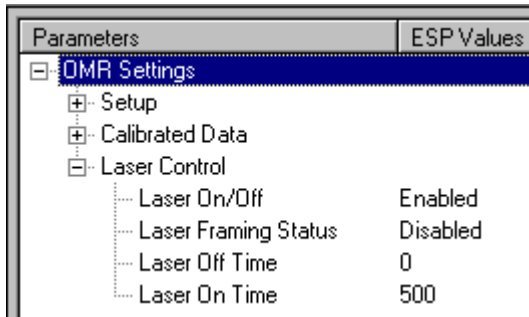

For information on laser controls, see [Chapter 10, "Laser Control"](#) for laser control setup.



# Chapter

# 8

# I/O Parameters

## Chapter Contents

I/O Parameters by ESP .....	8-2
I/O Parameters by Serial Command .....	8-2
Symbol Data Output .....	8-3
Noread Message .....	8-6
Beeper .....	8-7
Partial Output .....	8-8
Serial Verification .....	8-9
Output 1 Parameters .....	8-11
Output 2 Parameters .....	8-16
Output 3 Parameters .....	8-16
Quality Output .....	8-17

This section includes instructions for setting up data and discrete I/O controls of internal and external devices.

**Note:** When assigning characters in user-defined fields, the characters **NULL <>** and **,** can only be entered through embedded menus, not through ESP or serial commands.

# I/O Parameters by ESP

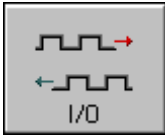

Click this button to bring up the **I/O Parameters** menu.

To open nested options, **single-click** the +.

To change a setting, **double-click** the setting and use your cursor to scroll through the options.

Parameters	ESP Values
[-] I/O Parameters	
[+] Symbol Data Output	Good Read
[+] Noread Message	Enabled
Beeper	On Good Read
[+] Partial Output	Disabled
[+] Serial Verification	
[+] Output 1 Parameters	
[+] Output 2 Parameters	
[+] Output 3 Parameters	
[-] Quality Output	
Quality Output Separator	
Reads/Trigger Status	Disabled

# I/O Parameters by Serial Command

Command Title	Legacy cmds	Format
Symbol Data/When to Output	<b>KI</b>	<K705, status, when to output>
Noread Message	<b>Kk</b>	<K714, status, message>
Beeper	<b>Ku</b>	<K702, status>
Serial Verification	<b>KS</b>	<K701, serial command echo status, serial command beep status, control/hex output>
Input 1	<b>KK</b>	<K730, mode, active state>
Output 1	<b>Kv</b>	<K810, output on, active state, pulse width, output mode, trend analysis mode, trigger evaluation period, number to output on, reads per trigger threshold>
Output 2	<b>Kw</b>	<K811, output on, active state, pulse width, output mode, trend analysis mode, trigger evaluation period, number to output on, reads per trigger threshold>
Output 3	<b>K'</b>	<K812, output on, active state, pulse width, output mode, trend analysis mode, trigger evaluation period, number to output on, reads per trigger threshold>
Quality Output	<b>KJ</b>	<K704, quality output separator, reads/trigger status>

# Symbol Data Output

*Usage:* Used when the host needs symbol data only under certain conditions.

*Definition:* Defines the conditions under which decoded symbols are transmitted to the host.

## Symbol Data Output Mode

*Serial Cmd:* <**K705**,*symbol data output mode*,when to output>

*Default:* **Good Read**

*Options:* 0 = Disabled                      2 = Mismatch  
1 = Match                                      3 = Good Read

### Disabled

*Usage:* Useful when an application only needs to use the discrete outputs and can allow the scanner to do the decision-making. When set to **Disabled**, the host does not need the symbol data and the communication lines are used only for setup and status checks.

*Definition:* When set to **Disabled**, the scanner will not transmit any data that is generated during a read cycle (symbols, noreads, etc.).

### Match

*Usage:* Used in an application that requires specific symbol data information and needs to sort, route or verify based on matching the specific symbol data.

*Definition:* When set to **Match**, the scanner transmits symbol data whenever a symbol data matches a master symbol. However, if **Matchcode Type** is set to **Disabled**, it transmits on any good read.

**Note:** A noread can still be transmitted if **Enabled**.

### Mismatch

*Usage:* **Mismatch** is typically used as a flag within the host system to prevent an item from being routed in the wrong container.

*Definition:* With **Mismatch** enabled, the scanner transmits symbol data whenever the symbol data information does NOT match the master symbol.

**Note:** A noread can still be transmitted if enabled.

---

## Symbol Data Output

### *Good Read*

*Usage:* **Good Read** is used when an application requires all symbol data to be transmitted. It's typically used in tracking applications in which each object is uniquely identified.

*Definition:* With **Good Read** enabled, the scanner transmits symbol data on any good read regardless of **Matchcode Type** setting.

**Note:** A noread can still be transmitted if enabled.



## When to Output Symbol Data

**Definition:** This command allows the user to choose when symbol data can be sent to the host.

**Serial Cmd:** `<K705,symbol data output mode,when to output>`

**Default:** **As Soon As Possible**

**Options:** 0 = As Soon As Possible 1 = End of Read Cycle

### As Soon As Possible

**Usage:** **As Soon As Possible** is useful in applications in which symbol data needs to be moved quickly to the host, typically when the host is making decisions based on symbol data.

**Definition:** Enabling **As Soon As Possible** causes symbol data to be sent to the host immediately after a symbol has been successfully decoded.

**Note:** More than one decode might in fact be required to qualify as a good decode, depending on how **Decodes Before Output** is set.

### End of Read Cycle

**Note:** See [“End of Read Cycle” on page 4-13](#) for options to end the read cycle.

**Usage:** **End of Read Cycle** is useful in timing-based systems in which the host is not ready to accept data at the time it is decoded.

**Definition:** Enabling **End of Read Cycle** means that symbol data does not get sent to the host until the read cycle ends with a timeout or new trigger.

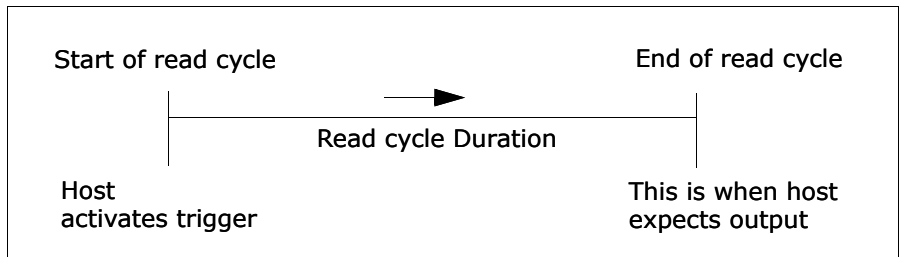

Figure 8-1 Read Cycle

## Noread Message

*Usage:* Used in applications where the host needs serial verification that a symbol has not been read and especially useful in new print verification.

*Definition:* When enabled, and if no symbol has been decoded before timeout or the end of the read cycle, the noread message will be transmitted to the host.

### *Noread Status*

---

*Serial Cmd:* <**K714**,*status*,*message*>

*Default:* **Enabled**

*Options:* 0 = Disabled          1 = Enabled

### *Noread Message*

---

*Definition:* Any combination of ASCII characters can be defined as the noread message.

*Serial Cmd:* <**K714**,*status*,*message*>

*Default:* **NOREAD**

*Options:* 0 to 64 ASCII characters.

**Note:** Noread Message will only be transmitted if **Symbol Data Output** (“**Symbol Data Output**” on page 8-3) is set to **Match**, **Mismatch** or **Good Read**.

**Noread Message** can be set to any ASCII characters except **NULL <>** and **,** (comma).

# Beeper

*Usage:* Can be used as an audible verification that either a good read or a noread has occurred.

*Definition:* A beep is emitted either after each good read of a bar code symbol or after each noread.

**Note:** Beeper will also sound if any of the following occur:

- the scanner is defaulted
- a send/save command from **ESP** or an **Exit** command from any embedded menu
- a **<Z>**, **<Zp>**, **<Zd>**, or **<KS,1>** command is sent

## *Beeper Status*

---

*Serial Cmd:* **<K702,status,volume>**

*Default:* **On Good**

*Options:*  
0 = Disabled  
1 = On Good Read  
2 = On Noread

## Partial Output

**Usage:** In **Multisymbol** mode, partial output is performed on each separate symbol. For example, if **Start Position** is set to 3 and **Partial Length** is set to 5, the following symbols are transmitted as follows:

1234567890 as 34567

1234 as 34

123456789,abcde as "34567,cde" (two symbols with separator)

12 as [blank]

**Definition:** When enabled, allows you to pre-select portions of symbols to be transmitted by the scanner.

---

### Partial Output Status

**Serial Cmd:** <K703,status,start position,length>

**Default:** Disabled

**Options:** 0 = Disabled      1 = Enabled

---

### Start Position (Partial Output)

**Definition:** Allows you to determine the first character from the beginning of a symbol to transmit.

**Serial Cmd:** <K703,status,start position,length>

**Default:** 1

**Options:** 1 to 63

---

### Length (Partial Output)

**Definition:** Allows you to determine the number of characters to be transmitted.

**Serial Cmd:** <K703,status,start position,length>

**Default:** 63

**Options:** 1 to 63

## Serial Verification

**Usage:** These commands are useful in removing any doubt about the scanner's acceptance and response to host configuration commands.

For example, if the current preamble is "SOM" and <Kd1, START> is entered, the scanner will echo back <Kd1, SOM> since the attempted entry "START" exceeds the four character limit for that command. Therefore it is rejected and the existing "SOM" message is echoed back and remains the preamble message.

**Definition:** Allows the user to verify configuration command status.

### Command Echo Status

**Important:** ESP will not function whenever this command is enabled.

**Definition:** When enabled, a configuration command received from the host is echoed back to the host with the resultant settings.

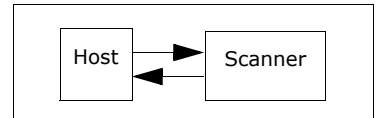

**Function:** If a command with multiple fields is processed, some of the fields may have been processed properly while others were not. The changes will appear in the string echoed back so that the user will know which fields did or did not change.

**Serial Cmd:** <K701,command echo status,command beep status,control/hex output>

**Default:** Disabled

**Options:** 0 = Disabled      1 = Enabled

# Operation Command Output

**Important:** This option must be enabled for ESP to operate.

*Usage:* Used when brackets are required to delineate certain scanner outputs such as counters.

*Definition:* Controls the output of command brackets.

*Serial Cmd:* **<K738,status>**

*Default:* **Enabled**

*Options:* 0 = Disabled      1 = Enabled

## *Disabled*

When set to disabled, the start and stop brackets < and > are not sent with responses to the operational commands such as <T> and <N> and utility commands such as counters and part number requests do not function.

## *Enabled*

Directs the scanner to bracket non-bar code scanner data such as counters with command start and stop characters, and echo the command to the host.

# Output 1 Parameters

**Usage:** This option provides switching to host software to control external devices such as PLCs and relays. It is useful for routing and sorting and to prevent mis-packaging and mis-routing.

**Definition:** Sets the discrete output functions for specific user-selected conditions.

## Output On

**Definition:** Allows the user to set the conditions under which an output (or outputs) will be activated.

**Serial Cmd:** *<K810,output on,active state,pulse width,output mode,trend analysis mode,trigger evaluation period,number to output on,decodes per trigger>*

**Default:** **Noread**

0 = Mismatch or Noread

3 = Noread

**Options:** 1 = Match

4 = Trend Analysis

2 = Mismatch

5 = Good Read

**Note:** If **Output On** is set to any mode containing **Match** or **Mismatch**, the transition (switching) will only occur if **Matchcode Type** is enabled and **Master Symbol(s)** are loaded into memory.

### **Mismatch or Noread**

Activates discrete output when the symbol data does not match that of the master symbol or the symbol has not been decoded before the end of the read cycle.

### **Match**

Activates a discrete output when the symbol data matches the master symbol.

### **Mismatch**

Activates a discrete output whenever the symbol data does not match that of the master symbol.

### **Noread**

Activates a discrete output whenever the symbol data is not decoded before the end of the read cycle.

### **Trend Analysis**

Activates discrete output when a trend analysis condition is met, depending on the trend analysis option enabled.

---

## Output 1 Parameters

### Active State

---

*Definition:* Sets the active state of the discrete output.

*Serial Cmd:* <**K810**,output on,active state,pulse width,output mode,trend analysis mode,trigger evaluation period,number to output on,decodes per trigger>

*Default:* **Normally Open**

*Options:* 0 = Normally Open                      1 = Normally Closed

### Pulse Width

---

*Definition:* Sets the time in 10mS increments that the discrete output remains active.

*Serial Cmd:* <**K810**,output on,active state,**pulse width**,output mode,trend analysis mode,trigger evaluation period,number to output on,decodes per trigger>

*Default:* **5** (.05 seconds). Corresponds to 50 mS displayed in the menu.

*Options:* 1 to 255 (0.01 to 2.55 seconds). Divide the number entered on the command line by 100 for time in seconds.



## Output Mode

---

**Definition:** Sets the condition in which the discrete output is de-activated.

**Serial Cmd:** <**K810**,output on,active state,pulse width,**output mode**,trend analysis mode,trigger evaluation period,number to output on,decodes per trigger>

**Default:** **Pulse**

**Options:**     0 = Pulse   2 = Latch Mode 2  
                  1 = Latch Mode 1                             3 = Latch Mode 3

### *Pulse*

**Definition:** This is the default mode of operation in which the programmable output is activated when the **Output On** condition has been met and held active for the duration of the selected pulse width.

### *Latch Mode 1 (Unlatch on Discrete Input 1)*

**Definition:** The programmable output is active when the **Output On** condition has been met and held active until the discrete **Input 1** has been activated.

### *Latch Mode 2 (Unlatch Opposite Condition)*

**Definition:** The programmable output is activated when the **Output On** condition has been met and held active until the opposite condition selected under **Output On** has been met.

For example, if **Noread** is enabled under **Output On**, the programmable output will go active upon a noread and remain active until the opposite condition, a good read, occurs.

### *Latch Mode 3 (Unlatch Re-enter Read Cycle)*

**Definition:** The programmable output is active when the **Output On** condition has been met and is held active until a new read cycle begins.

**NOTE:** All of the **Output On** modes are inhibited when any **Output on Warning** is active for **Output 1** (see <K713> command).

## *Trend Analysis Mode*

---

*Usage:* Useful in cases in which the user doesn't want to shut down for one condition but wants to monitor quality and read conditions.

*Definition:* Sets the trend condition (**Mismatch**, **Noread**, or **Reads/Trigger**) that will activate the output.  
Parameters associated with **Trend Analysis Mode** are **Number To Output On** and **Trigger Evaluation Period**. The **Number To Output On** setting allows the user to select the number of times that the selected trend condition occurs before activating the output. **Trigger Evaluation Period** sets the number of triggered events to evaluate for trend condition.

Example:

*Trend analysis mode = Noread*

*Number to Output On =4*

*Trigger Evaluation Period=25*

In this example, the scanner will activate the output when 4 noreads occur within a period of 25 trigger events (read cycles).

*Serial Cmd:* <**K810**,output on,active state,pulse width,output mode,**trend analysis mode**,trigger evaluation period,number to output on,decodes per trigger>

*Default:* **Noread**

### *Mismatch*

*Definition:* Output will be activated when the number of **Mismatches** equals the value entered for **Number to Output On** within the trigger window selected in **Trigger Evaluation Period**.

### *Noread*

*Definition:* The output will be activated when the number of noreads equals the value entered for **Number to Output On** within the trigger window selected in **Trigger Evaluation Period**.

### *Decodes per Trigger*

*Definition:* Monitors the number of good reads per triggered read cycle. If the number of decodes per trigger falls below the value entered in **Decodes per Trigger**, a trend condition is set. If this trend condition matches the number set in **Number to Output On**, the output will be activated.

## Trigger Evaluation Period

---

**Definition:** The number of trigger events to examine within the trend analysis event.

**Serial Cmd:** <K810,output on,active state,pulse width,output mode,trend analysis mode,trigger evaluation period,number to output on,decodes per trigger>

**Default:** 0

**Options:** 0 to 255

**Note:** For Trend Analysis to function the **Number To Output On** and the **Trigger Evaluation Period** must be 1 or more.

## Number to Output On

---

**Definition:** Sets the number of events (matches, mismatches, noreads, etc. as configured by **Output On**) that must occur before activating the associated output.

**Serial Cmd:** <K810,output on,active state,pulse width,output mode,trend analysis mode,trigger evaluation period,number to output on,decodes per trigger>

**Default:** 1

**Options:** 1 to 255

**Note:** For Trend Analysis to function the **Number To Output On** and the **Trigger Evaluation Period** must be 1 or more.

**Note:** The number of matches, etc. for this setting does not need to be sequential.

## Decodes per Trigger

---

**Definition:** When **Reads/Trigger** trend analysis mode is enabled, the **Reads per Trigger Threshold** value is the minimum number of successful reads required during a read cycle.

**Helpful Hints:** You can determine the expected number of scans during a read cycle by multiplying the enabled **Number of Scans** per second times the number of seconds in the read cycle.

**Serial Cmd:** <K810,output on,active state,pulse width,output mode,trend analysis mode,trigger evaluation period,number to output on,decodes per trigger>

**Default:** 0

**Options:** 0 to 65,535

# Output 2 Parameters

*Serial Cmd: <K811,output on,active state,pulse width,output mode,trend analysis mode,trigger evaluation period,number to output on,decodes per trigger>*

**Output 2** has the same parameters and default settings as **Output 1**.

Output 2 Parameters	
Output On	Noread
Active State	Normally Open
Pulse Width	5
Output Mode	Pulse
Trend Analysis Mode	Noread
Trigger Evaluation Period	0
Number to Output On	0
Decodes per Trigger	0

# Output 3 Parameters

*Serial Cmd: <K812,output on,active state,pulse width,output mode,trend analysis mode,trigger evaluation period,number to output on,reads per trigger threshold>*

**Output 3** has the same parameters and default settings as **Output 1**.

Output 3 Parameters	
Output On	Noread
Active State	Normally Open
Pulse Width	5
Output Mode	Pulse
Trend Analysis Mode	Noread
Trigger Evaluation Period	0
Number to Output On	0
Decodes per Trigger	0

## Quality Output

*Usage:* Host system can monitor scanning performance (printing process, scanning environment changes, etc.) by setting thresholds in their processing or displaying the outputs for visual verification. For example, a certain symbol that has been averaging 00100 reads per read cycle suddenly drops to 00012, this would be a good indication that a problem has arisen even though good reads are still occurring.

*Definition:* Allows the host to track the number of good reads per trigger by appending a five digit numeric field to the end of bar code symbol data.

### *Quality Output Separator*

---

*Serial Cmd:* <**K704,quality output separator,decodes/trigger status**>

*Default:* , (comma)

*Options:* any ASCII character

**Note:** If **Quality Output Separator** has been changed to any other character and you want to re-define the separator as a comma, you will need to define it in the embedded menu or default the scanner by a <Zd> command.

**Note:** For all serial configuration commands, the following characters cannot be used: < > **NUL**

### *Decodes/Trigger Status*

---

*Definition:* When enabled, bar code data is followed by a separator, followed by the five digits in the form of 00000.

*Serial Cmd:* <**K704,quality output separator,deocdes/trigger status**>

*Default:* **Disabled**

*Options:* 0 = Disabled      1 = Enabled



# Chapter

# 9

# Diagnostics

## Chapter Contents

Diagnostics by ESP Menu .....	9-2
Diagnostics by Serial Command.....	9-2
Counts .....	9-3
Hours Since Last Reset .....	9-4
Warning Messages .....	9-5
Present Operating Temperature (deg. C) .....	9-8
High Temperature Threshold .....	9-9
Low Temperature Threshold .....	9-10
Lifetime Hours.....	9-11

**Important:** Since **Warning Messages** and **NOVRAM Messages** are not enabled by default, these messages will not be displayed. However, if you suspect that erroneous defaults are occurring, enable **Warning Messages** and **NOVRAM Messages** by sending **<K"1,,,1>**.

**Note:** When assigning characters in user-defined fields, the characters **NULL <>** and **,** can only be entered through embedded menus, not through ESP or serial commands.

# Diagnostics by ESP Menu



Click this button to bring up the **Diagnostic** menu.

To open nested options, **single-click** the +.

To change a setting, **double-click** the setting and use your cursor to scroll through the options.

Parameters	ESP Values
[-] Diagnostic Settings	
[+] Counts (Read Only)	
[+] Hours Since Reset (Read Only)	
[+] Warning Messages	Disabled
Present Operating Temperature	0
[+] High Temperature Threshold	
[-] Low Temperature Threshold	
Degrees	1
Message	LOW_TEMP
[-] Lifetime Hours	
Hours Threshold	2500
Message	SERVICE



# Diagnostics by Serial Command

Command Title	Legacy cmds	Format
Power-on/Resets Counts	<b>K_</b>	< <b>K406,?</b> > returns power-ons,resets>
Hours Since Reset	<b>K@?</b>	< <b>K407?</b> > returns: hours,minutes (read only)
Warning Messages	<b>K"</b>	< <b>K400</b> , warning message status,laser high status,laser low status,novram/reset warning status>
Laser High	<b>K;</b>	< <b>K404</b> ,message>
Laser Low	<b>K:</b>	< <b>K405</b> ,message>
Present Operating Temperature	<b>K%?</b>	< <b>K408?</b> > returns: deg (read only)
High Temperature	<b>K+</b>	< <b>K402</b> ,degrees,message>
Low Temperature	<b>K-</b>	< <b>K403</b> ,degrees,message>
Lifetime Hours	<b>K\$</b>	< <b>K401</b> ,hours10,message>

# Counts

(These commands are READ ONLY.)

## *Power-on*

---

*Usage:* Used for detecting unwanted resets caused by power supply problems or ESD transients.

*Definition* Returns the number of times the scanner has been re-powered or a watchdog reset occurs.

*Serial Cmd:* Send <K406?>  
Returns <K\_*power-ons*,resets>

*Read Only Ranges:* 0 to 65,535 power-ons.

## *Resets*

---

*Usage:* Used for detecting unwanted resets caused by power supply problems or ESD transients.

*Definition* Resets include watchdog reset, <A>, <Z>, <Zd>, and hardware defaults. A watchdog reset is a reset that is forced whenever the software locks-up.

*Serial Cmd:* Send <K406?>  
Returns <K\_*power-ons*,resets>

*Read Only Ranges:* 0 to 65,535 resets.

## Hours Since Reset

(This command is READ ONLY.)

*Usage:* Used as a troubleshooting tool that can help pinpoint the cause of a reset.

*Definition:* Records the number of hours and minutes of operation since the last system reset.

*Serial Cmd:* Send **<K?>**  
Returns **<K407 hours,minutes>**

*Read Only Ranges:* 0 to 23 hours, 0 to 59 minutes.

## Warning Messages

**Important Note: Warning Message Status** must be enabled before any warnings in this menu can be displayed.

*Usage:* These messages serve as a flag to service a scanner or as an early warning that potential problems could arise. They are particularly useful in factories that run 24/7 and can't afford down time.

*Definition:* Warning messages that relate to the environment and condition of the scanner can be defined and set to activate specific outputs.

**Note:** When enabled, the error condition will override all other operational modes configured for the output.

When enabled, laser current and NOVRAM warning messages will be transmitted to the host or any active port whenever the pre-defined conditions are met.

*Function:* When enabled, warning messages will be transmitted to the host or any active port.

**Note:** This option must be enabled before any other warning messages can be transmitted.

### *Warning Message Status*

---

*Serial Cmd:* <**K400, warning message status**,laser high status,laser low status,  
novram corrupt warning status>

*Default:* **Disabled**

*Options:* 0 = Disabled      1 = Enabled

---

## Laser High

---

When enabled, a message is transmitted whenever the laser current exceeds a factory-calibrated reference value which cannot be altered. The message repeats once every 30 minutes until the condition is corrected.

### Laser High Status

*Usage:* Alerts the user to impending laser failure. (Contact your service representative.)

*Definition:* Enables the **Laser High** message.

*Serial Cmd:* <**K400**,warning message status,**laser high status**,laser low status,novram corrupt warning status>

*Default:* **Enabled**

*Options:* 0 = Disabled            1 = Enabled

### Laser High Message

*Definition:* Defines the **Laser High** message.

*Serial Cmd:* <**K404**,**laser high message**>

*Default:* **HIGH\_LASER**

*Options:* Any 1 to 10 character ASCII string except **NUL**, <, or >.

---

## Warning Messages

### *Laser Low*

---

When enabled, a message is transmitted whenever the laser current falls below a factory-calibrated reference value which cannot be altered. The message repeats once every 30 minutes until the condition is corrected.

#### Laser Low Status

*Usage:* Alerts the user to impending laser failure. (Contact your service representative.)

*Definition:* Enables the **Laser Low** message.

*Serial Cmd:* <**K400**,warning message status,laser high status,**laser low status**,novram corrupt warning status>

*Default:* **Enabled**

*Options:* 0 = Disabled            1 = Enabled

#### Laser Low Message

*Definition:* Defines the **Laser Low** message.

*Serial Cmd:* <**K405**,**laser low message**>

*Default:* **LOW\_LASER**

*Options:* Any 1 to 10 character ASCII string except **NUL**, **<**, or **>**.

**Note:** If you suspect that erroneous defaults are occurring, enable **NOVRAM Messages** by sending <**K400**,**1,,,1**>. This will allow the **NOVRAM** messages, if present, to be viewed.

## Present Operating Temperature (deg. C)

(This command is READ ONLY.)

*Usage:* Used for setting **Over Temperature Threshold** and **Under Temperature Threshold**.

*Definition:* Indicates temperature of the environment immediately outside of the scanner.

A thermal sensor on the main PCB measures the internal temperature of the scanner. From this, a case-differential constant is subtracted to yield an estimated external temperature.

*Serial Cmd:* Send: <**K408?**>  
Returns <**K408**degrees Celsius>.

**Note:** When viewing the **Present Operating Temperature**, allow at least 20 minutes after startup for the scanner's inside and outside temperatures to stabilize.

## High Temperature Threshold

A message can be defined that will display when a user-set **High Temperature Threshold** has been reached. The message repeats once every 30 minutes until the condition is corrected. This value is a reference to the external ambient temperature in the environment around the scanner.

### *High Temperature Degrees*

---

*Usage:* Helps ensure that the scanner is being used within its temperature specification. Also, since hotter environments tend to shorten the life of electronics components, a user may want to set the temperature threshold closer to the nominal temperature of 25°.

*Definition:* A user can set a temperature value that when exceeded will cause a high temperature message to be displayed. If **High Temperature Threshold** is set to zero, then the warning message will be disabled

*Serial Cmd:* <**K402**,degrees,message>

*Default:* **50° Celsius**

*Options:* 0° to 50°, zero disables.

### *High Temperature Message*

---

*Definition:* The user can enter a message of up to 10-characters that will be displayed whenever **High Temperature Threshold** is exceeded.

*Serial Cmd:* <**K402**,degrees,message>

*Default:* **HIGH\_TEMP**

*Options:* Any 1 to 10 character ASCII string except **NUL**, **<**, or **>**.



---

# Low Temperature Threshold

A message can be defined that will display when a user-set **Low Temperature Threshold** has been reached. The message repeats once every 30 minutes until the condition is corrected. This value is a reference to the external ambient temperature in the environment around the scanner.

---

## *Low Temperature Degrees*

*Usage:* Helps ensure that the scanner is being used within its temperature specification.

*Definition:* The user can set a low temperature value that, whenever the ambient temperature falls below it, causes a low temperature message to be displayed. If **Low Temperature Threshold** is set to zero, the warning message will be disabled.

*Serial Cmd:* <**K403**,degrees,message>

*Default:* 1° Celsius

*Options:* 0° to 50°, zero disables.

---

## *Low Temperature Message*

*Definition:* The user can enter a message of up to 10-characters that will be displayed whenever the ambient temperature falls below the **Low Temperature Threshold**.

*Serial Cmd:* <**K403**,degrees,message>

*Default:* **LOW\_TEMP**

*Options:* Any 1 to 10 character ASCII string except **NUL**, <, or >.

## Lifetime Hours

A message can be defined that will be transmitted whenever the scanner's elapsed time clock exceeds the set hours threshold. The message repeats one time every 30 minutes.

### *Hours Threshold*

---

*Usage:* Used for setting up a preventive maintenance program.

*Definition:* A user can set a time in hours that will cause a message to be sent whenever the scanner's run time exceeds this value.

The elapsed time is the time the scanner is powered up.

*Serial Cmd:* <**K401**,*hours10*,*message*>

*Default:* **2500** (x 10 = 25,000 hours)

*Options:* 0 to 65534

Note: Hours entered are 1/10 of the actual hours.

### *Message*

---

*Definition:* The user can enter a message of up to 10-characters that will be displayed whenever the hours threshold is reached or exceeded.

*Serial Cmd:* <**K401**,*hours10*,*message*>

*Default:* **SERVICE**

*Options:* Any 1 to 10 character ASCII string except **NUL**, **<**, or **>**.

# Chapter

# 10

# Laser Control

## Chapter Contents

Laser Control by ESP Menu .....	10-2
Laser Control by Serial Command .....	10-2
Laser On/Off .....	10-3
Laser Framing Status .....	10-4
Laser Off Time .....	10-5
Laser On Time .....	10-6

By regulating the time that the laser is on during each scan, the laser beam width can be narrowed to a precise arc. This is called "laser framing" and it is very useful when there is a need to avoid highly reflective objects, to filter out unwanted signals, or to avoid scanning the wrong symbols. In addition, the laser can be set so that it only turns on during a read cycle.

# Laser Control by ESP Menu

Click this icon to bring up the **Laser Control** view.

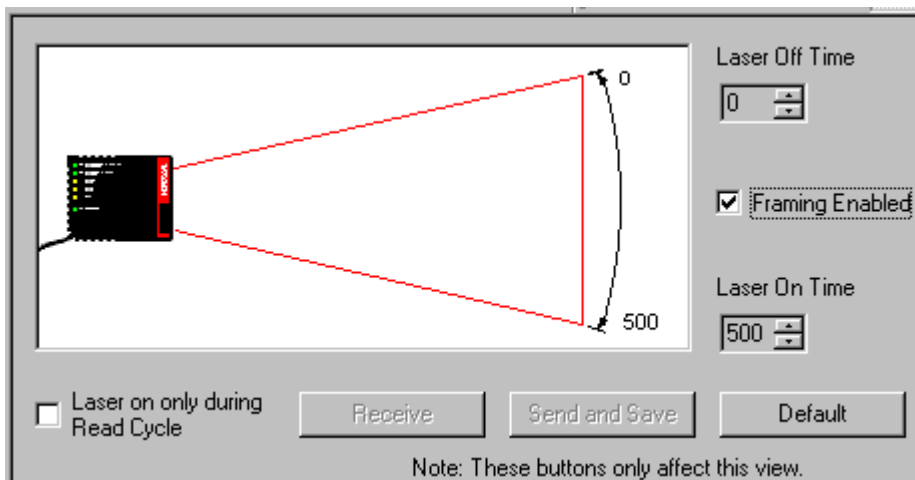

You can also adjust laser parameters from the **Read Cycle** and the **OMR** menus.



## Laser Control by Serial Command

Command Title	Legacy cmds	Format
Laser Control		<i>&lt;K700 laser on/off, laser framing status, laser off time, laser on time&gt;</i>

## Laser On/Off

- Usage:* **Laser On/Off** extends the life of the laser. It is useful where there are significant time gaps between symbols. It also provides visual confirmation of a read cycle timeout and minimizes laser exposure to people.
- Definition:* When enabled, the laser is ON only during the read cycle. When disabled, the laser operates continuously.
- Serial Cmd:* **<K700laser on/off,laser framing status,laser off time,laser on time>**
- Default:* **Disabled**
- Options:* 0 = Disabled      1 = Enabled

# Laser Framing

To adjust laser framing, click the **Laser Control** button, and **Laser On/Off** arrows up or down as shown here.

**Usage:** This is useful to avoid highly reflective objects, for filtering out unwanted signals, and avoiding the wrong symbols.

**Definition:** Sets the percentage of time the laser is ON during each scan so that only a selected portion of the scan width is effectively scanned.

When **Laser Framing** is disabled, the laser is ON during the full scan arc.

**Serial Cmd:** <K700,laser on/off,laser framing status,laser off time,laser on time>

**Default:** **Disabled**

**Options:** 0 = Disabled      1 = Enabled

**Note:** Laser framing adjustments for OMR symbols are best made in the OMR menu.

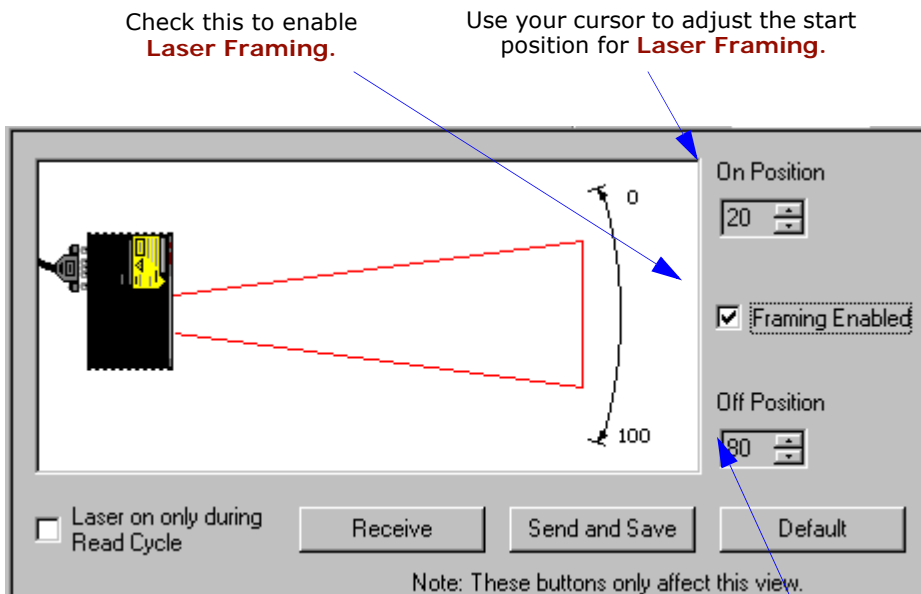

Figure 10-1 Laser Framing

**Note:** This view may be slightly different for each model.

# Laser Off Time

**Definition:** Duration of laser off time, in increments of 1/500th of the total scan width.

**Important:** The combined values of **Laser Off Time** and **Laser On Time** cannot exceed 500 which is the duration of one scan.

**Serial Cmd:** <K700,laser on/off,laser framing status,**laser off time**,laser on time>

**Default:** 0

**Options:** 0 to 500

Because scan widths are not always perfectly symmetrical, the most effective way to setup laser framing is to experiment with the **Laser On Time** and **Laser Off Time** commands until you get the best results.

The laser can be turned off between read cycles and the duration of the scan and hence the width of the scan can also be adjusted.

**Figure 10-2** provides a visual representation of how the laser beam width can be controlled by the length of time the laser is on during each scan.

When setting up **Laser Framing** in ESP, use the **Off Time** and **On Time** arrows to constrain or expand the laser framing area as shown on **figure 10-2 on page 10-5**.

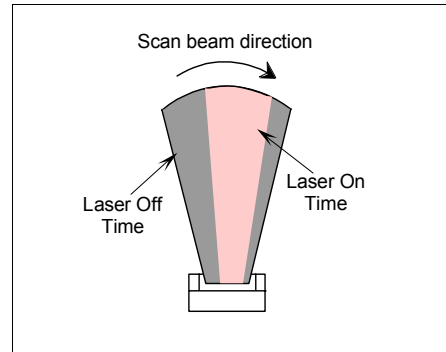

Figure 10-2 Laser Framing Sketch

## Laser On Time

*Definition:* Duration of laser off time, in increments of 1/500th of the total scan width.

**Important:** The combined values of **Laser Off Time** and **Laser On Time** cannot exceed 500 which is the duration of one scan.

*Serial Cmd:* <**K700**,laser on/off,laser framing status,laser off time,**laser on time**>

*Default:* **500**

*Options:* 0 to 500



# Chapter

# 11

# Terminal Mode

## Chapter Contents

Terminal Window .....	11-2
Find Function .....	11-3
Macros .....	11-4
Terminal Window Functions.....	11-5

This section describes the terminal window and macro functions.

# Terminal Window

To use the terminal mode, click on the **Terminal** button.



You will see the following window:

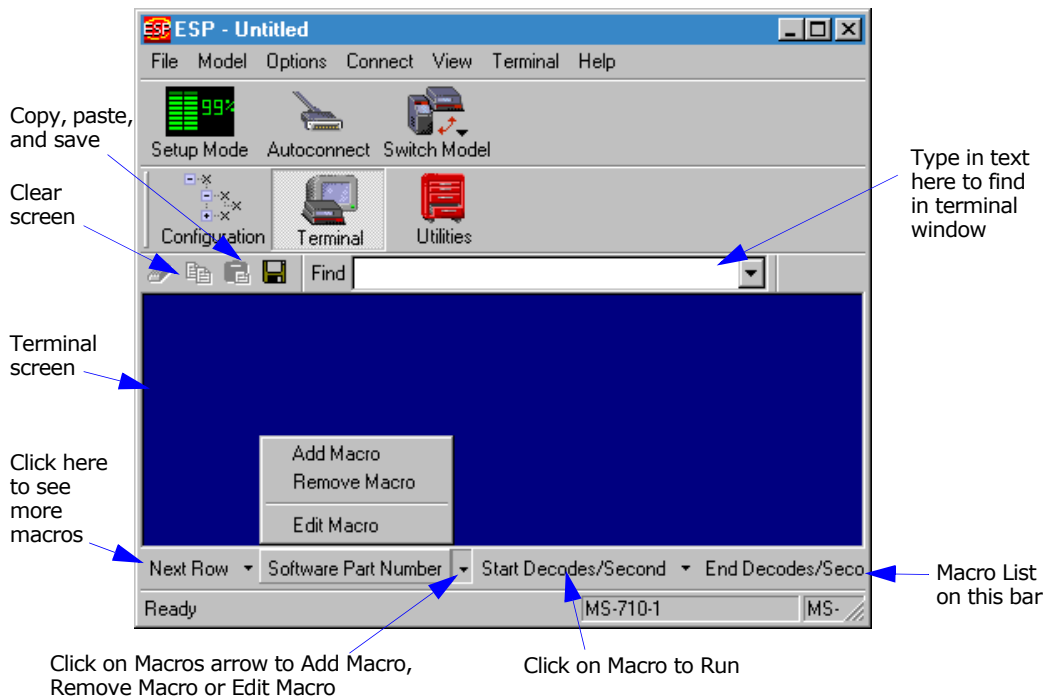

The terminal screen allows you to enter serial commands (in **red**) from the macro box, by copying, or directly from your keyboard.

The terminal screen also displays symbol data or information from the scanner (in **blue**).

You can also right click in the terminal screen to bring up a handy option box.

# Find Function

The **Find** box allows you to enter text strings to be searched for in the terminal window. For example a series of symbols have been scanned into the terminal view and you want to determine if a particular symbol starting with ABC has been read.

1. Type **ABC** into the **Find** box.



2. Press the **return key**.  
The first instance of **ABC** will be high-lighted in the terminal window.
3. Press the **F3** key to search again for the next instance of **ABC**.
4. Press **Shift-F3** to search for the previous instance of **ABC**.

# Macros

Macros can be stored in a macro selection bar, edited in a separate window, and executed by clicking on the macro name.

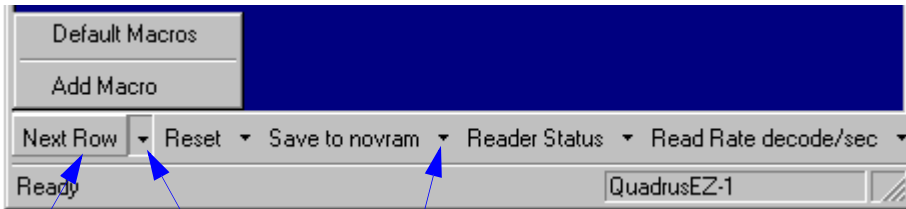

Click on **Next Row** to see the next row of macros

Click on any arrow to **Add, Default** or **Edit** macros. When you default macros, the entire macros set is restored to their original macro commands.

When you click on the macro name, the macro is executed in the terminal window. If this is a serial command, the command is also sent to the scanner at the same time it is displayed.

## Editing a Macro

When you click the arrow next to a any macro and select **Edit**, the following appears:

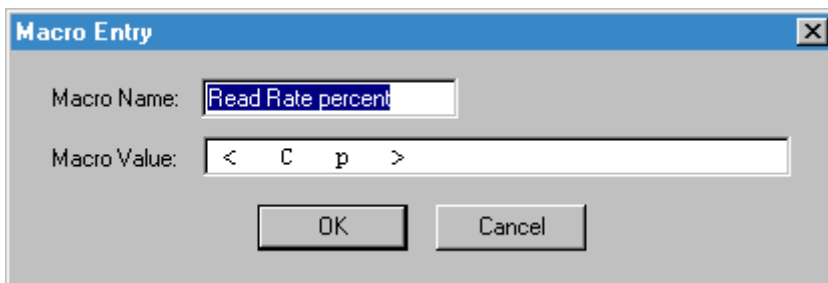

You can edit an existing macro or type in a new macro name and define it in the **Macro Value** text box. Click **OK**.

# Terminal Window Functions

Right-click on the terminal window to display the following:

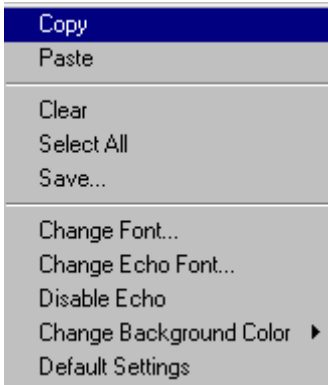

- **Copy** selected text to clipboard.
- **Paste** from terminal or computer text.
- **Clear** all text in terminal window.
- **Select All** text in the terminal window.
- **Save...** brings up a save as dialog box.
- **Change Font...** of data text, brings up a text dialog.
- **Change Echo Font...** to change typed in text or commands.
- **Change Background Color** of terminal window.
- **Default Settings** changes all the above back to default settings.

## *Terminal Pulldown Menu*

The pulldown **Terminal** menu has **Capture and Save Current Text** as well as the functions defined above.

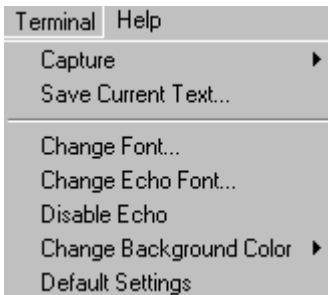

- **Capture** lets you append data in real time to a text file of your choice. While in operation, the text file cannot be opened. You can select **Pause** to interrupt the capture flow or **Stop** to end the flow and open the file.
- **Save Current Text...** saves all text in the terminal window to a text file of your choice.



# Chapter

# 12

# Utilities

## Chapter Contents

Utilities by ESP Menu .....	12-2
Utilities by Serial Command .....	12-3
Read Rate .....	12-5
Counters .....	12-7
Device Control .....	12-9
Master Database .....	12-11
Firmware .....	12-16
Autodiscrimination .....	12-19
Scanner Status Requests .....	12-20

Utility commands are generally commands that are performed during scanner operations to check read rates, determine read rates or perform miscellaneous operations on scanner hardware. Serial utility commands are not prefaced with a "K", nor do they require an initialization command (<A> and <Z>). They can be entered from within any terminal program or from within ESP in the **Terminal** window.

## Utilities by ESP Menu



Click this button to bring up the **Utilities** menu





# Utilities by Serial Command

Table 12-1 Summary of Utility Serial Commands

Command Type	Command	Name
Read Rate	<Cp>	Enter Single Symbol Percent Rate Test
	<C>	Enter Single Symbol Decode Rate Test
	<Ce>	Extended Read Rate
Counters	<J>	Exit Decode Rate and Percent Rate Test
	<T>	Trigger Counter
	<U>	Trigger Counter Reset
	<V>	Good Read/Match Counter
	<W>	Good Read/Match Counter Reset
	<N>	Noread Counter
	<O>	Noread Counter Reset
	<X>	Mismatch Counter
Device Control	<Y>	Mismatch Counter Reset
	<L1>	Output #1 Pulse
	<L2>	Output #2 Pulse
	<L3>	Output #3 Pulse
	<I>	Disable Scanner
	<H>	Enable Scanner
	<KF> or <K501>	Send Motor Off
	<KF>	Send Motor Off
	<KE> or <K500>	Send Motor On
	<KE>	Send Motor On
Master Database	<#>	Master Symbol Database Size
	<E>	Enable Master Symbol
	<F>	Disable Master Symbol
	<Mmaster symbol number,data>	Enter Data to Database for Specified Symbol. <b>Note:</b> <K231,#,data> does the same.
	<M#?>	Request Master Symbol Data For Specific Symbol <b>Note:</b> <K231,#,?> does the same.
	<M?>	Request all Master Symbol Information <b>Note:</b> <K231,?> does the same.
	<Mmaster symbol number,>	Delete Master Symbol <b>Note:</b> <K231,#,> does the same.
Firmware	<!>	Display Checksums of EPROM
	<!b>	Display Checksum for Boot Code
	<!a>	Display Checksum for Application Code
	<#>	Display Part Number
	<#b>	Display Boot Code Part Number
	<#a>	Display Application Code Part Number
Symbol Types	<P>	Autodiscriminate All Codes
	<Q>	Enable Code 39 Only
	<R>	Enable Codabar Only
	<S>	Enable I 2/5 Only
Trigger	<char>	Serial Trigger Character
Restore/Save <sup>a</sup>	<A>	Reset (does not save for power-on)
	<Ad>	Restore Default Settings
	<An>	Restore Saved Settings

---

## Utilities by Serial Command

Table 12-1 Summary of Utility Serial Commands

	<Z>	Reset/Save (for power-on)
	<Zp>	Save Factory Settings
	<Zd>	Save/Restore Factory Defaults
Status Requests	<?>	Scanner Status
	<?1>	Extended Scanner Status
	<K?>	Configuration Status

a. See [Appendix H — “Defaulting/Saving/Initializing”](#).

# Read Rate

*By ESP*

You can access **Read Rate** from the **Utilities** menu.

To start or end a read rate test, right-click **Read Rate** and select **Start** or **Stop**.

To change from percent read rate to decodes per second, first end the read rate by selecting **Stop**, then right-click select **Decodes/Sec**.

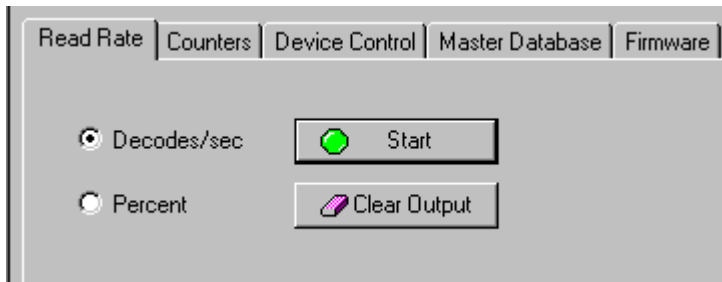

## *Read Rate by Serial Command*

### *Enter Single Symbol Percent Test*

Sending **<Cp>** instructs the scanner to transmit the percentage of decodes and any scanned symbol data.

### *Enter Multisymbol Percent Enter Single Symbol Decodes/Second Test*

Sending **<C>** instructs the scanner to transmit the decodes per second and symbol data (if any). The decode rate can vary dramatically due to the angle and location of the symbol in relation to the scan line. This test is very useful in aligning and timing the scanning device during installation.

### *Test*

Sending **<Cm>** instructs the scanner to transmit the percentage of scans decoded and symbol data (if any) for multiple symbols.

### *Enter Multisymbol Decode Rate Test*

Sending **<Cs>** instructs the scanner to transmit the decode rate and symbol data (if any) for multiple symbols.

### *Enable Extended Rate Test for Single and Multisymbol*

Sending **<Ce>** after **<C>** or **<Cs>** will generate an extended mode that applies to both single and multiple symbols.

Extended mode instructs the scanner to output the decode rate, the symbol data, and

## Read Rate

the transition data.

Decode rate	Symbol Information	Number of symbol bar and space transitions
800	Decodes/Sec MICROSCAN4	TRANS = 66
808	Decodes/Sec MICROSCAN4	TRANS = 67
808	Decodes/Sec MICROSCAN4	TRANS = 66
832	Decodes/Sec MICROSCAN4	TRANS = 65
808	Decodes/Sec MICROSCAN4	TRANS = 67
804	Decodes/Sec MICROSCAN4	TRANS = 65
832	Decodes/Sec MICROSCAN4	TRANS = 64

**Note:** Example shows output when Postamble is enabled and defined as a carriage return and a line feed.

**Note:** The <Ce> command has no immediate effect if not preceded by <C> or <Cs>.

### End Read Rate Test

Sending <J> ends both the **Percent** test and the **Decodes/Second** test for both single and multi-symbol.

# Counters

Counter commands can be a numeric value from 00000 to 65,535. After reaching the maximum numeric limit of 65,535, the counter will automatically roll-over and start counting again at 00000. To obtain the cumulative total of counts after the roll-over has occurred, add 65,536 per each roll-over (the scanner does not keep track of the number of roll-overs) to the current count.

**Note:** All counter values will be lost if power is recycled to the scanner or the scanner receives a reset or save command.

## Counters By ESP

You can access **Counters** from the **Utilities** menu.

Click **Request All** or **Request** for a specific counter to display count. Click **Clear** to set counter to zero.

The screenshot shows a software interface with five tabs: Read Rate, Counters, Device Control, Master Database, and Firmware. The 'Counters' tab is selected. At the top of the Counters panel are two buttons: 'Request All' (highlighted with a dashed border) and 'Clear All'. Below these are four rows of controls, each with a 'Request' button, a 'Clear' button, and a text input field:

- Row 1: Request, Clear, Trigger: [input field]
- Row 2: Request, Clear, Good Read: [input field]
- Row 3: Request, Clear, Noread: [input field]
- Row 4: Request, Clear, Mismatch: [input field]

## *Counters by Serial Command*

---

### *Trigger Counter*

Sending **<T>** displays the total number of triggers since the last reset.

### *Trigger Counter Reset*

Sending **<U>** sets the trigger counter to 00000.

### *Good Read/Match Counter*

Sending **<V>** displays the total number of good reads matching the master symbol or, if Master Symbol is not enabled, the number of good reads since the last reset. This counter is always enabled, but will only work as a match count when Master Symbol is enabled. If Master Symbol is not enabled, this counter records the number of good reads. This count can be requested at any time.

### *Good Read/Match Counter Reset*

Sending **<W>** sets the Match Counter to 00000.

### *Noread Counter*

Sending **<N>** displays the total number of noreads that have occurred since the last reset.

### *Noread Counter Reset*

Sending **<O>** sets Noread Counter to 00000.

### *Mismatch Counter*

With Matchcode enabled, sending **<X>** displays the number of decoded symbols since the last reset that do not match the master symbol.

### *Mismatch Counter Reset*

Sending **<Y>** sets the Mismatch Counter to zero.

# Device Control

*By ESP*

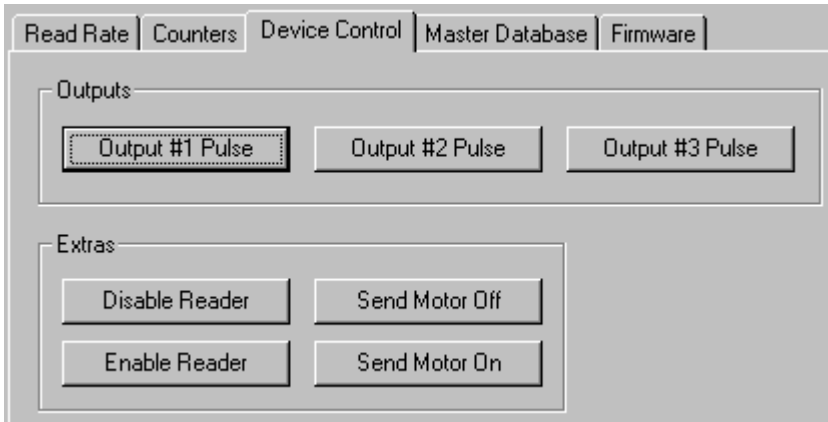

## *Device Control By Serial Command*

### *Output #1 Pulse*

Sending **<L1>** activates the link between Output 1(+) and Output 1(-) (regardless of Master Symbol or Output 1 status).

### *Output #2 Pulse*

Sending **<L2>** activates the link between Output 2(+) and Output 2(-) (regardless of Master Symbol or Output 2 status).

### *Output #3 Pulse*

Sending **<L3>** activates the link between Output 3(+) and Output 3(-) of the host connector (regardless of Master Symbol or Output 3 status).

### *Disable Scanner*

Sending **<I>** will turn the laser off and end the current read cycle. This feature is useful during extended periods of time when no symbols are being scanned or the scanner is being configured. Disabling laser scanning will not affect any downloaded commands to the scanner.

**Note: Disable Laser Scanning** does not relate to **Laser On/Off**, which when enabled also turns off the laser but only between read cycles.

### *Enable Scanner*

Sending **<H>** will turn the laser on continuously.

---

## *Device Control*

**Note:** **Enable Laser Scanning** does not relate to **Laser On/Off** command.

### *Send Motor Off*

Sending **<KF>** turns the spinning mirror motor off. This command is useful for long idle periods.

**Note:** Laser turns off whenever motor is off.

### *Send Motor On*

Sending **<KE>** turns the spinning mirror on (if not already running).

**Note:** The spinning mirror reaches full speed after a short time delay.

see [Chapter 6, "Matchcode."](#)



# Master Database

**Important:** **Master Database** is used only for comparing entire symbols, when **Sequential** and **Wild Card** are NOT enabled, and **Start Position** is equal to **0**.

## Master Database Overview

**Usage:** Used where more than one master symbol is required, as in a **Multisymbol** setup, for matching and other matchcode operations.

**Definition:** Allows you to define up to 10 master symbols as the master symbol database, which can be entered by keyboard, scanned in, displayed, or deleted by serial or ESP commands.

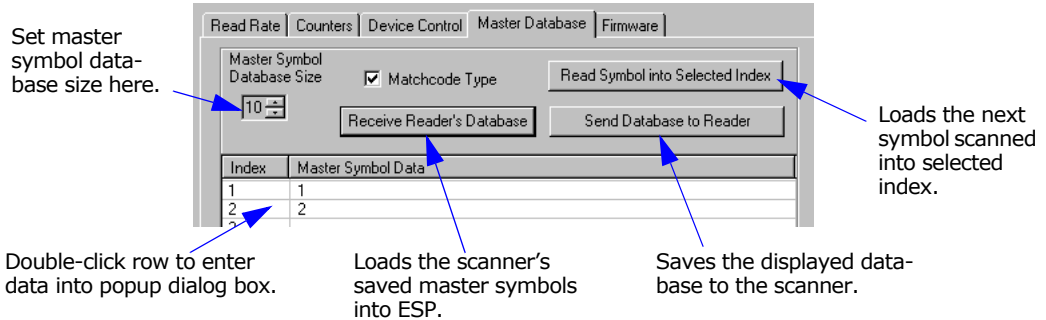

## Master Symbol Database Size

**Definition:** **Master Symbol Database Size** allows you to select 1 to 10 master symbols for the master symbol database.

**ESP:** First set the number of master symbols you want to include by using **Master Symbol Database Size** and entering the number.

**Serial Cmd:** **<KMmaster symbol database size>**

**Default:** **1**

**Options:** 1 to 10

## Enter Master Symbol Data

**Definition:** Allows you to enter master symbol data for a specific master symbol index number (1 to 10) provided the index number is not larger than the number of symbols enabled by the **Master Symbol Database Size** (see [page 12-11](#)). For example, if **Master Symbol Database Size** is set to 2, you will not be able to enter data for symbols 3 through 10.

- ESP:**
1. Set the number of master symbols you want to create in **Master Symbol Database Size**.
  2. **Double-click** in the row of the index number you want to setup.

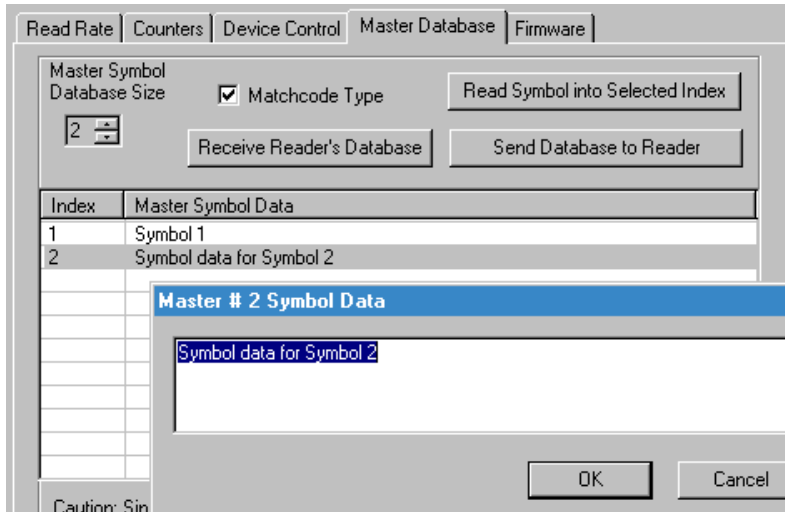

3. Copy or type data into the Master Symbol dialog box and click **OK**.
4. Click **Send Database to Scanner** to save to the scanner.

**Serial Cmd:** **<Mmaster symbol number, master symbol data>**

**Default:** **1**

**Options:** 1 to 10 (any combination of ASCII text up to the maximum in [Table 12-2](#)). For example, to enter data for master symbol 9, after making certain that master symbol database size is enabled for 9 or more symbols, send **<M9,data>**.

**Caution:** Since the total number of characters available for the master symbol database is **2710204564**, changes to the **Master Symbol Database Size** will re-allocate the number of characters available for each master symbol and could cause existing master symbols to be deleted (except master symbol #1 unless it also exceeds the size limitation).

[Table 12-2](#) specifies the maximum number of characters available to each symbol according to the number of master symbols defined, from 1 through 10.

See “Master Symbol Database Size” on page 12-11.

Table 12-2 Maximum Characters for Master Symbol Database

Number of Master Symbols	Maximum Characters	Number of Master Symbols	Maximum Characters
#1	2045	#6	340
#2	1022	#7	291
#3	681	#8	254
#4	510	#9	226
#5	408	#10	203

## Store Next Symbol Scanned as Master Symbol

**Definition:** After you’ve set the size in the database, you can order the scanner to store the next symbol decoded as the master symbol

**Serial Cmd:** <**G**master symbol number>

To store the next symbol scanned as master symbol #1 send: <**G**> or <**G1**>. For all symbols numbers except 1, the number must be included.

**Options:** 1 to 10

**ESP:** In the **Master Database** tab in the **Utilities** menu:

1. Select the master symbol index number in which you want to store the symbol data.
2. Click **Read Symbol into Selected Index**.



Read Symbol into Selected Index

The next symbol decoded will be read into the selected index.

## Request Master Symbol Data

**Definition:** Returns master symbol data for any enabled master symbols from 1 to 10. For example, for a database in which the master symbol database size has been set to 5 or more, send **<M5?>** to request master symbol data for #5. The scanner transmits master symbol #5 data in the following format: **<5/data>**. If no master symbol data is available, the output will be: **<5/>**.

**ESP:**

1. Click the **Utilities** button and the **Master Database** tab.
2. Click on the **Receive Scanner's Database** button.

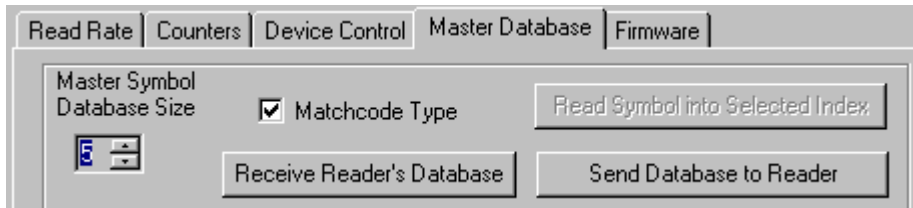

**Serial Cmd:** **<Mmaster symbol number?>** (Returns all master symbols if no number is added before the question mark)

**Caution:** Be sure to add the **?** or you will delete the master symbol(s).

**Default:** Returns all master symbols if no number is included.

**Options:** 1 to 10

## Delete Master Symbol Data

**Definition:** This command will delete the master symbol data for a selected master symbol number.

- ESP:**
1. Click the **Utilities** button to access the master symbol.
  2. Click the **Master Database** tab and **double-click** the symbol number you want to delete.
  3. Delete text and click **OK** to delete in ESP.

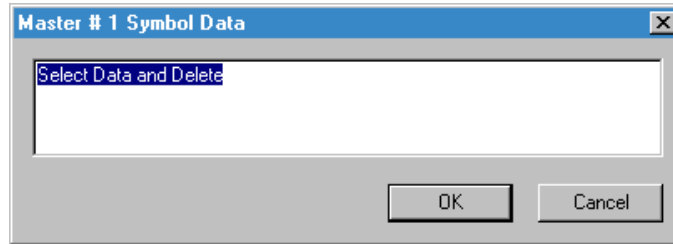

4. Click **Send Database to Scanner** to save in the scanner.

**Serial Cmd:** **<Mmaster symbol number,>** deletes the master symbol for the selected symbol index.

**Caution:** If no number is added before the question mark, all master symbols will be deleted.

**Options:** 1 to 10

# Firmware

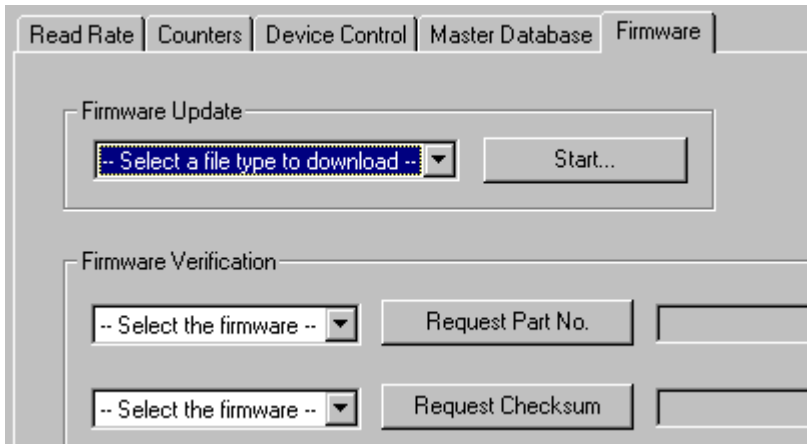

## Firmware Update

Application code versions are specific to your scanner. Consult with your sales representative before downloading application code. If needed, an application code will be sent to you in the form of a **\*.mot** file.

To download application code:

1. First make sure the host is connected to your scanner.
2. Apply power to the scanner.
3. Before updating, you should verify the current firmware (see [“Firmware Verification — Part Number” on page 12-17](#)).
4. Click in the **Firmware Update** text box and select the file type you want to download. This will open a file locator box.
5. Navigate to the appropriate file (a **\*.mot** file) and open the file.

As application code begins to download to the scanner, the scanner will go silent, the scanner’s RDY and GD/RD LEDs will flash intermittently, and a progress indicator at the bottom of the ESP window will let you know when the download is complete.

**Caution:** Do not interrupt power or disconnect the host cable while download is in progress.

## Firmware Verification – Part Number

You can send a request for scanner's current firmware part numbers.

### By ESP

1. From the **Utilities** menu you can access **Firmware Verification** from the **Firmware** tab.
2. Select the firmware code you want to check and click **Request Part No.** to see the associated part number.



### By Serial Command

Upon sending **<#>** the scanner returns software part numbers for application code **<#a/\_\_\_\_>** and boot code **<#b/\_\_\_\_>**.

Individual part numbers for **Application Code** and **Boot Code** are returned when their respective commands **<#a>** and **<#b>** are sent.

## Firmware Verification – Checksum

A checksum verifies a scanner's flash memory.

### By ESP

1. From the **Utilities** menu you can access **Firmware Verification** from the **Firmware** tab.
2. Select the firmware code you want to check and click **Request Checksum** to see the associated part number.

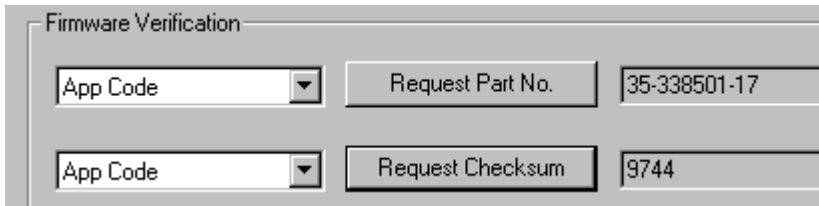

Firmware Verification		
App Code	Request Part No.	35-338501-17
App Code	Request Checksum	9744

### By Serial Command

Upon sending **<!>** the scanner returns two 4-digit hex numbers that are the checksums for boot code and the application code.



# Autodiscrimination

You can enable most or specific symbol types by the following operational commands.

*Default:*        **Code 39 (only)**

*Options:*        **<P>** Enables most symbol types.

**<Q>** Enable Code 39 only

**<R>** Enable Codabar only

**<S>** Enable I 2/5 only

# Scanner Status Requests

## <?> Scanner Status Byte

The scanner responds to a status request <?> with a two character hex value, for example <?/22>. To determine the status:

1. Look up the binary conversion in [table 12-3](#).  
For example, the first **2** in binary would be **0 0 1 0** as read from binary digits 3 through 0; the second **2** the binary digits 7 through 4 which is also **0 0 1 0**.
2. Next, enter your binary values in [table 12-4](#) in the "Binary" column next to the appropriate bit.

Table 12-3 Hex Value to Binary Conversion

Table 12-4 Scanner Status

Bit	Binary	Scanner Status
0	0	Command error detected
1	1	Command received
2	0	Communication error detected
3	0	Flash sector unprotect failure
4	0	Host/Aux port buffer overflow
5	1	Scanner is in a read cycle
6	0	Software Watch dog reset
7	0	Hardware Watch dog reset

Hex Value	Binary Bit Digits			
	7	6	5	4
0	0	0	0	0
1	0	0	0	1
2	0	0	1	0
3	0	0	1	1
4	0	1	0	0
5	0	1	0	1
6	0	1	1	0
7	0	1	1	1
8	1	0	0	0
9	1	0	0	1
A	1	0	1	0
B	1	0	1	1
C	1	1	0	0
D	1	1	0	1
E	1	1	1	0
F	1	1	1	1

3. Under "Binary," interpret **1s** as true and the **0s** as not true. For example, bit 1 has a **1** in the "Binary" column, indicating "Command Received." Bit 5 is also a **1** indicating that the "Scanner is in a read cycle."

## <?1> Extended Status

The scanner responds to an extended status request <?1> with several fields, for example: <?/22><35-559002-11,35-55900118,A1D6,085C,D96F,D96F>.

These represent, in order: the status byte as discussed above, the boot part number (35-559002-11), application part number (35-559001-18), boot checksum (A1D6), RAM parameter checksum (085C), and novram parameter checksum (D96F).

## <K?> Configuration Command Status

Returns the current status of all configuration commands.

# Appendices

## Chapter Contents

Appendix A General Specifications .....	A-2
Appendix B Electrical Specifications.....	A-5
Appendix C IB-131 Interface Module.....	A-10
Appendix D Serial Configuration Commands .....	A-13
Appendix E Serial Command Format .....	A-16
Appendix F ASCII Table .....	A-18
Appendix G Embedded Menus.....	A-20
Appendix H Defaulting/Saving/Initializing .....	A-21
Appendix I Test Decode Rate.....	A-25
Appendix J Formulas for Number of Decodes.....	A-27
Appendix K Operational Tips .....	A-30
Appendix L Interface Standards .....	A-31
Appendix M Multidrop Communications .....	A-32
Appendix N Glossary of Terms.....	A-37

# Appendix A — General Specifications

## Key Features

- Multiple symbol and symbology reading
- 3 programmable outputs
- Industrial IP54 rated enclosures
- 2000 scans and decodes per second
- Ultra compact size
- OMR reading option
- Invisible ink option
- Read rate LEDs

## Mechanical

Depth: 3.0 in (76.2mm)

Width: 2.275" (57.8mm)

Height: 1.625 in. (41.3mm)

Weight: 11 oz. (311g)

## Environmental

Enclosure rating: IP54

Operating temperature: 0° to 40°C

Storage temperature: -50° to 75°C  
(-58° to 167°F)

Humidity: Up to 90% (non-condensing)

## Emissions and Immunity

General immunity for light industry:  
EN 50082:97

Radiated and conducted emissions of ITE equipment:  
EN 55022:98, Class A

## Laser Light

Type: Laser Diode

Output Wavelength: 650nm nominal

Safety class:

CDRH Class II, 1.0mW max.

Optional: Invisible Ink

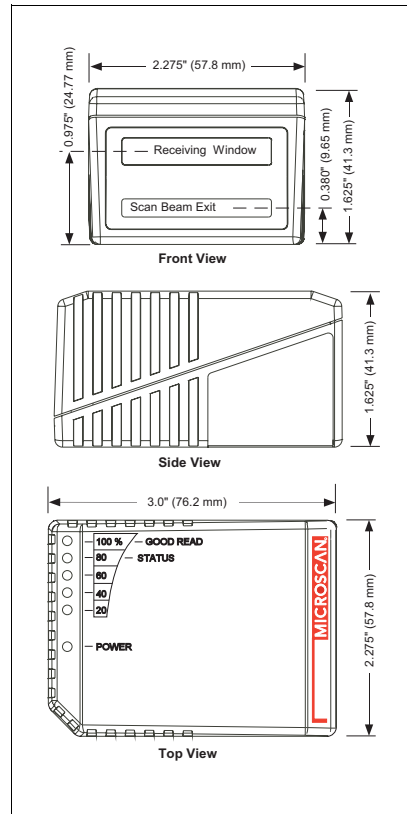

Figure A-1 MS-9  
Dimensions

### Scanning Parameters

Scanning mirror type: Rotating, single line 9-faceted

Scan Rate: 2000 scans per second

Scan width angle: Typically 56°; Pitch: ±°

### Communication

RS-232, RS-422/485, Daisy chain can be used with an accessory IB-131 Interface

### Symbologies

Standard offering: Code 128, Code 39, Code 93, Codabar, Interleaved 2 of 5, UPC/EAN

Special offering: OMR, Pharmacode

### FIS Options

FIS #	Density	Line	Software	Ink
001	Low Density	Single Line	Standard	Visible
002	High Density	Single Line	Standard	Visible
003	Low Density	Single Line	Standard + OMR	Visible
004	High Density	Single Line	Standard + OMR	Visible
005	Low Density	Raster	Standard	Visible
006	High Density	Raster	Standard	Visible
007	Low Density	Single Line	Standard + Pharmacode	Visible
1001	Low Density	Single Line	Standard	Invisible
1002	Low Density	Raster	Standard	Invisible
1003	Low Density	Single Line	OMR	Invisible

### Mounting Specifications

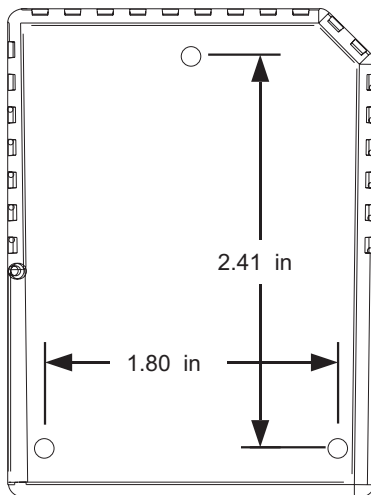

Drill three **0.203** inch (**5.16** mm) diameter holes.

**Caution:** Maximum penetration depth of screws is **0.30** inch (**0.762** cm).

**Caution:** To prevent twisting or distortion of the scanner housing, ensure that the mounting surface is flat.

Figure A-2 MS-9 Mounting

---

## General Specifications

### LED Indicators

Table A-1 MS-9 Status Lights

LED	State	Status
POWER	Green-On	Scanner has power
	Off	No power
GOOD READ (100%) (not in read rate test)	On	Scanner is ready to read
	Off	Scanner is not ready to read
STATUS (80%) (not in read rate test)	On	Scanner is in a read cycle <sup>a</sup>
	Off	Scanner is not in a read cycle
20%, 40%, 60%, 80%, 100%	On	Represents the percentage of good reads <sup>b</sup>

a. In **Continuous** and **Continuous1**, the status light is always on.

b. If these LEDs are flashing in a pattern and the scanner is not in a read rate test, there is an error pattern. Contact Microscan support.

### Read Ranges Safety Certifications

FCC, CDRH, CE, UL/cUL, BSMI

Product specifications are given for typical performance at 25°C (77°F) using grade A symbols. Some performance characteristics may vary at high temperatures or other environmental extremes.

© 2015 Microscan Systems, Inc. Specifications subject to change.

# Appendix B — Electrical Specifications

Narrow-bar-width	Low Density		High Density
	Visible Ink	Invisible Ink	
.005" (.127mm)			1.75" to 3" (44 to 76mm)
.0075" (.190mm)	2" to 5" (51 to 127mm)		1.5" to 4" (38 to 101mm)
.010" (.254mm)	1.5" to 6" (38 to 152mm)	1.5" to 4" (38 to 101mm)	
.015" (.381mm)	1" to 7" (25 to 178mm)	1.5" to 6" (38 to 152mm)	
.020" (.508mm)	1" to 9" (25 to 229mm)	1.5" to 6" (38 to 152mm)	

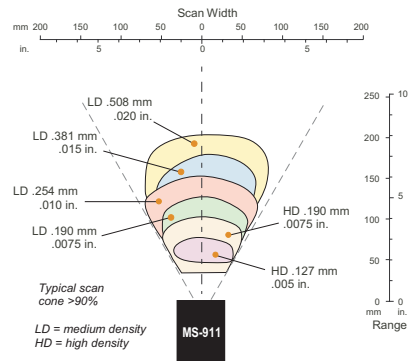

Figure A-3 MS-9 Read Range Graph

Maximum Operating Power: 6.5 Watts

Cabling: Power Input: 10 to 28VDC, 200mV p-p max. ripple, 185mA @ 24VDC (typical)

Trigger, New Master: 4.5 to 28 VDC (optoisolated)

OMR & New Master Trigger Input: Optoisolated, 10 to 28 VDC Outputs (1,2,3): 1 to 28VDC (optoisolated) rated

( $I_{CE} < 100\text{mA}$  @24VDC, current limited by user)

3-foot cable terminated with a 15-pin high density D-Sub connector plug.

Table A-2 MS-9 Host Connector, 15-pin

Pin	Host RS232	Host & Aux RS232	Host RS422/485	In/Out
1	Power +10 to 28 VDC			In
2	TxD	TxD	TxD (-)	Out
3	RxD	RxD	RxD (-)	In
4	Power/Signal ground			
5	Trigger (-)			In
6	RTS	Aux TxD	TxD (+)	Out
7	Output 1 (+)			Out

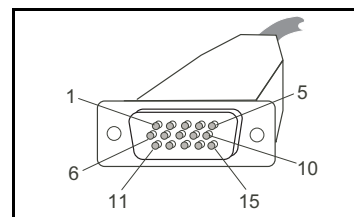

Figure A-4 MS-9 Connector

---

## Electrical Specifications

8	Default configuration <sup>a</sup>			In
9	Trigger (+)			In
10	CTS	Aux RxD	RxD (+)	In
11	Output 3 (+)			Out
12	New master/OMR input			In
13	Chassis ground <sup>b</sup>			
14	Output 2 (+)			Out
15	Outputs 1, 2, 3 (-)			Out

Pin arrangement for 15-pin high density D-subminiature connector plug at the end of 3-foot cable.

- a. The default is activated by connecting pin 8 to ground pin 4. See **“By Hardware Default” on page A-22.**
- b. Chassis ground: Connects chassis body to earth ground only. Not to be used as power or signal return.

**Caution:** If using your own power supply, verify correct connection of power and ground lines. Incorrect connections or use of “Chassis ground,” “Power ground,” and “Signal ground” lines could cause equipment and/or software failure.



## Optoisolator Outputs

Optoisolator circuits can transfer pulses between the scanner and peripherals with no direct connection with the scanner's internal circuitry. However, not every optoisolator configuration provides complete isolation. The following diagrams show both fully optoisolated and non-optoisolated circuits. They are only examples and do not represent all the possible wiring configurations.

	$I_{load} = 5\text{ mA}$	$I_{load} = 50\text{ mA}$	$I_{load} = 100\text{ mA}$
$V_{Out-On}^a$	0.7V	0.9V	1.0V
$t_{On-Typ}$	15 $\mu\text{S}$	20 $\mu\text{S}$	30 $\mu\text{S}$
$t_{Off-Typ}$	1000 $\mu\text{S}$	150 $\mu\text{S}$	75 $\mu\text{S}$

a. Voltage drop across output when activated.

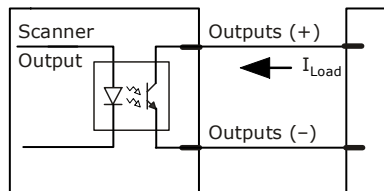

## Output Circuit Examples

### Fully Optoisolated

This circuit is fully optoisolated and is the recommended configuration. It allows the user to apply 1 to 28 VDC to the circuit.

**Caution:** The maximum current that can pass through the optoisolator is 100mA.

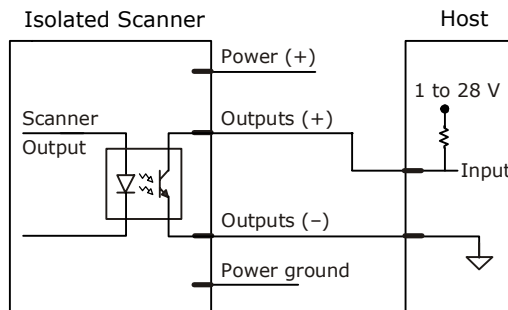

### Not Optoisolated, Scanner Grounded

In this diagram, power is applied externally, but the scanner's power ground is used to complete the circuit. This setup involves some risk to the optoisolator if excessive voltages are applied.

**Caution:** The maximum current that can pass through the optoisolator is 100mA.

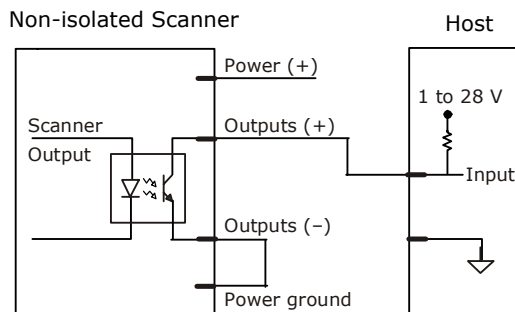

# Electrical Specifications

## Additional Isolated Output Circuit Examples

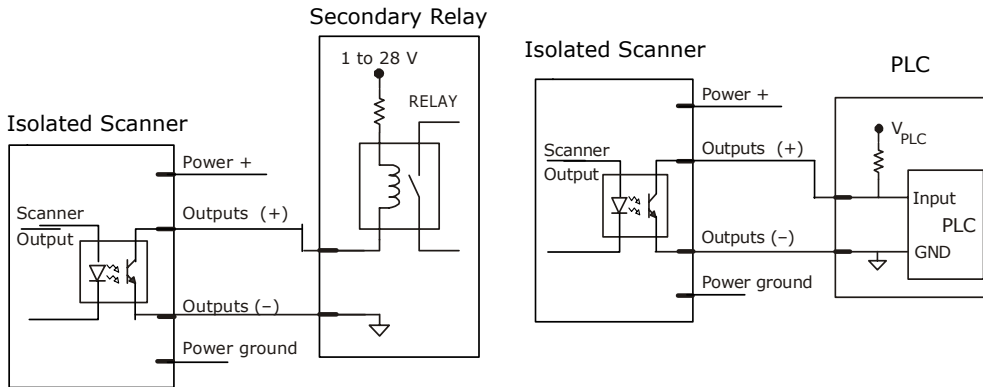

## Optoisolator Inputs

All discrete inputs can be fully isolated pulses as PNP or NPN circuits. Inputs include trigger, new master, OMR, and input 1

	Minimum	Maximum
$V_{IN-HIGH}/I_{IN-HIGH}$	4.5 V/8 mA	28 V/26 mA
$V_{IN-LOW}/I_{IN-LOW}$	0 V/0 mA	3 V/2 mA
Pulse Width <sub>min</sub>	4 $\mu$ S	

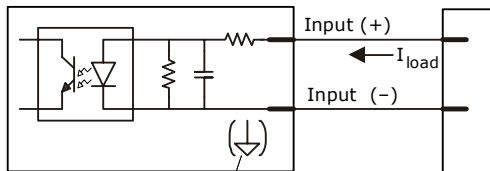

New master pin and OMR input (-) is internally grounded.

## Input Examples

### Fully Optoisolated

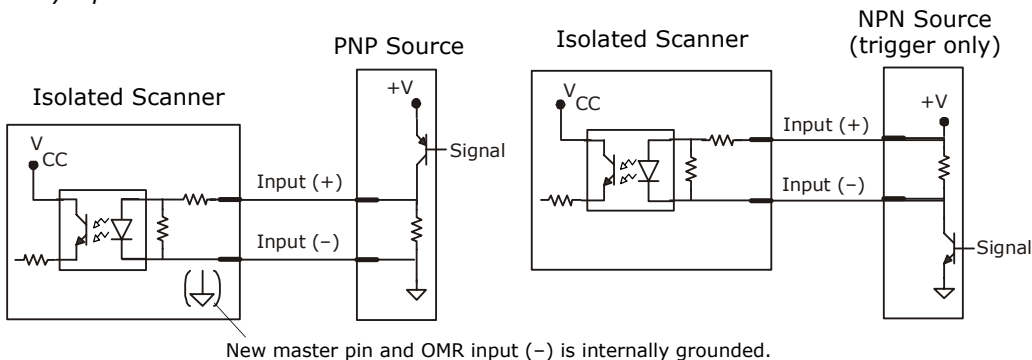

# Appendix C — IB-131 Interface Module

The IB-131 interface module simplifies connecting to the scanner by providing separate ports for the host, power supply, trigger and network. The network port is used for mul-tidrop or daisy chain configurations. See the following pages for configuration diagrams and a list of cables offered by Microscan for ease of connectivity when using the IB-131.

*Table A-3 Host 25-pin Connector*

1	External ground
2	Transmit data (RS-232)
3	Receive data (RS-232)
4	RTS
5	CTS
6	Output 2 (+)
7	Signal ground
8	Output 1 (+)
9	Trigger (-)
10	Trigger (+)
11	Default configuration
13	Receive data RS-422 (+)
14	Transmit data RS-422 (-)
15	Output 3 (+)
16	Receive data RS-422 (-)
17	Output 1/2/3 (-)
19	Transmit data RS-422 (+)
25	New master/OMR (in)

*Table A-4 Trigger 4-pin Connector*

1	Power + 10 to 28VDC (out) <sup>a</sup>
2	Trigger (-) (in) <sup>b</sup>
3	Power Ground
4	Trigger (+) (in) <sup>a</sup>

- a. For NPN type, connect pins 1 and 4, send signal to pin 2
- b. For PNP type, connect pins 2 and 3, send signal to pin 4.

*Table A-5 Power 3-pin Connector*

1	Power Ground
3	Power + 10 to 28VDC (in)

*Table A-6 Scanner 15-pin Connector*

1	Power + 10 to 28 VDC (out)
2	Transmit RS-232/RS-422 (-)
3	Receive RS-232/RS-422 (-)
4	Power/Signal Ground
5	Trigger (-) (out)
6	RTS/Aux Transmit/RS-232/RS-422 (+)
7	Output 1 (+)
8	Default configuration
9	Trigger (+) (out)
10	CTS/Aux Receive RS-232/RS-422 (+)
11	Output 3 (+)
12	New master/OMR (out)
13	External ground
14	Output 2 (+)
15	Output 1/2/3 (-)

*Table A-7 Network 25-pin Connector*

1	Ground
2	Aux Receive RS-232
3	Aux Transmit RS-232
6	Output 2 (+)
7	Signal ground
8	Output 3 (+)
13	Receive data/RS-422 (+)
14	Transmit data/RS-422 (-)
15	Output 3 (+)
16	Receive data/RS-422 (-)
17	Output 1/2/3 (-)
19	Transmit data (RS-422+)

**Electrical:**

Voltage Input: Regulated +10 to 28VDC

**Cabling:**

RS-232 Cable: 61-300026-03

Multidrop Cable: 61-100030-03

Daisy Chain Cable: 61-100029-03

**Mechanical:**

Length: 3.2 in. (8.13 cm)

Width: 3.15 in. (8 cm)

Height: 0.75 in. (1.9 cm)

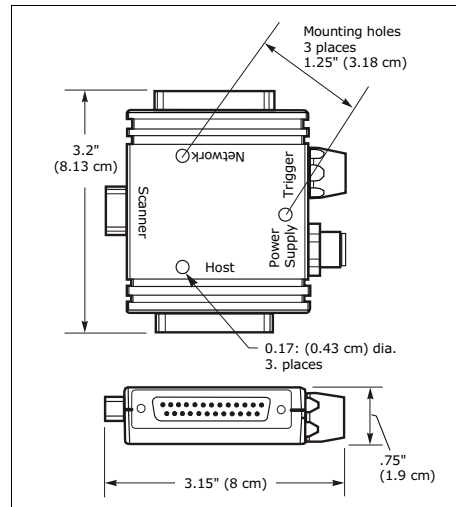

Figure A-5 IB-131 Mechanical

*Scanner to IB-131*

With this configuration the scanner communicates directly with the host through the IB-131.

**IB-131:** 99-000018-01  
(1 per MS-9)

**Host RS-232 Serial Cable:**  
61-300026-03

**Power Supply:** 97-100004-15

**Trigger:** 99-000017-01

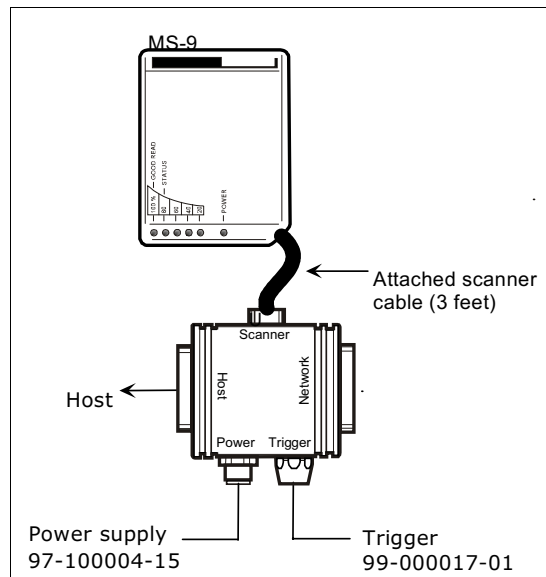

Figure A-6 MS-9/IB-131 Typical Setup

## *Multidrop*

---

This setup allows the user to link multiple scanners together, using only one host.

**IB-131:** 99-000018-01  
(1 per MS-9)

**Multidrop Cable:** 61-100030-03  
(connects multiple IB-131s)

**Power Supply:** 97-100004-15  
(for each scanner)

**Trigger:** 99-000017-01 (for each scanner)

## *Daisy Chain*

---

This setup allows the user to link multiple scanners together, using only one host.

**IB-131:** 99-000018-01  
(1 per MS-9)

**Daisy Chain Cable:** 61-100029-03 (connects multiple IB-131s)

**Power Supply:** 97-100004-15  
(for each scanner)

**Trigger:** 99-000017-01  
(for each scanner)

## Appendix D — Serial Configuration Commands

The following table is a list of all the available serial configuration commands (also called "K commands"). These commands are also listed at the beginning of each applicable chapter. For utility (operational) commands see [Table 12-1, "Summary of Utility Serial Commands," on page 12-3.](#)

Table A-8 Complete List of Serial Configuration Commands

Command Title	Legacy cmds	Format
<b>Communications</b>		
Host Port Parameters	<b>Ka</b>	<K100,baud,parity,stop bits,data bits>
Host Protocol	<b>Kf</b>	<K140,protocol>
Aux Port Parameters	<b>Ky</b>	<K101,aux port mode,baud,parity,stop bits,data bits,daisy chain status,daisy chain ID>
Daisy Chain Scanner ID		<K151,daisy chain scanner,daisy chain scanner ID>
Preamble	<b>Kd</b>	<K141,status,preamble>
Postamble	<b>Ke</b>	<K142,status,postamble>
LRC	<b>Kc</b>	<K145,status>
Intercharacter Delay	<b>KB</b>	<K144,time interval>
Response Timeout	<b>KA</b>	<K143,timeout>
Network Client		<K120,net port status>
Serial Gateway Configuration		<K125,length status,rx from network size,tx to network size,pad status,pad char,begin/end justify data status,byte swap status>
DeviceNet		<K121,deviceNet baud rate,deviceNet address>
Profibus		<K122,profibus station address>
DataHighway Plus		<K123,DHP baud rate,DHP address>
<b>Read Cycle</b>		
Multisymbol	<b>KL</b>	<K222,number of symbols,multisymbol separator>
Trigger Mode	<b>Kg</b>	<K200,trigger mode,trigger filter duration>
External Trigger State	<b>Kj</b>	<K202,external trigger state>
End of Read Cycle	<b>Kh</b>	<K220,end of read cycle mode,read cycle timeout>
Serial Trigger Character	<b>Ki</b>	<K201,character>
Good Decode Reads	<b>Km</b>	<K221,good decode reads>
Gain/Tracking	<b>KD</b>	<K504,gain,tracking>
Scan Speed		<K500,scan speed>
Automatic Gain Control	<b>KH</b>	<K505,AGC sampling status,transition counter>
Video Settings	<b>KI</b>	<K502,maximum element,video filter time,minimum symbol transitions>
<b>Symbologies</b>		
OMR Setup		<K490,status,parity status,# fields,trigger delay mode,# scans,gate bar location,trigger delay type,output style>
OMR Calibration	<b>KP</b>	<KPcalibrate delay status,auto frame status,avg bar width,avg cell width,leading margin,scan count value>

## Serial Configuration Commands

Table A-8 Complete List of Serial Configuration Commands

Code 39	<b>Kp</b>	< <b>K470</b> ,status,check digit status,check digit output status,large intercharacter gap,fixed symbol length status,fixed symbol length,full ASCII set>
Code 128/EAN-128	<b>Kt</b>	< <b>K474</b> ,status,fixed symbol length status,fixed symbol length,EAN-128 status,output format,application record separator status,application record separator character,application record brackets,application record padding>
Interleaved 2 of 5	<b>Kr</b>	< <b>K472</b> ,status,check digit status,check digit output,symbol length #1,symbol length #2,guard bar>
Codabar	<b>Kq</b>	< <b>K471</b> ,status,start & stop match,start & stop output,large intercharacter gap,fixed symbol length status,fixed symbol length,check digit type,check digit output>
UPC/EAN	<b>Ks</b>	< <b>K473</b> ,UPC/EAN status,EAN status,supplementals status,separator status,separator char,supplemental type>
Code 93	<b>Kl</b>	< <b>K475</b> ,status,fixed symbol length status,fixed symbol length>
Pharmacode		< <b>K477</b> ,status,fixed symbol length status,fixed symbol length,min. no. of bars,bar widths,fwd/rev>
PDF417	<b>Kl</b>	< <b>K476</b> ,status,raster sweeps before decode attempt,fixed symbol length status,fixed symbol length>
Narrow Margins/Symbology ID	<b>Ko</b>	< <b>K450</b> ,narrow margins status,symbology identifier>
Background Color	<b>Kx</b>	< <b>K451</b> ,background color>
<b>I-O Parameters</b>		
Symbol Data/When to Output	<b>Kl</b>	< <b>K705</b> ,symbol data output mode,when to output>
Noread Message	<b>Kk</b>	< <b>K714</b> ,status,message>
Beeper	<b>Ku</b>	< <b>K702</b> ,status>
Serial Verification	<b>Ks</b>	< <b>K701</b> ,serial command echo status,serial command beep status,control/hex output>
Input 1	<b>Kk</b>	< <b>K730</b> ,mode,active state>
Output 1	<b>3Kv</b>	< <b>K810</b> ,output on,active state,pulse width,output mode,trend analysis mode,trigger evaluation period,number to output on,reads per trigger threshold>
Output 2	<b>Kw</b>	< <b>K811</b> ,output on,active state,pulse width,output mode,trend analysis mode,trigger evaluation period,number to output on,reads per trigger threshold>
Output 3	<b>K'</b>	< <b>K812</b> ,output on,active state,pulse width,output mode,trend analysis mode,trigger evaluation period,number to output on,reads per trigger threshold>
Quality Output	<b>KJ</b>	< <b>K704</b> ,quality output separator,reads/trigger status>
<b>Matchcode</b>		
Matchcode Type	<b>Kn</b>	< <b>K223</b> ,type,sequential matching,match start position,match length,wild card character,sequence on noread,sequence on mismatch>
Sequential Step		< <b>K228</b> ,sequence step>
New Master Pin	<b>Kz</b>	< <b>K225</b> ,status>
Master Symbol Database Size	<b>KM</b>	< <b>K224</b> ,number of master symbols>



Table A-8 Complete List of Serial Configuration Commands

Optoelectric Control		<K226,mode,# active database settings,latch on trigger,timer value, control trigger 1,control trigger 2,control trigger 3>
Optoelectric Calibration Database		<K227,database index,focus position,gain,tracking>
Enter/Delete Master Symbol Data	<b>M</b>	<K231, master symbol number, master symbol data [no data will delete current master symbol data]>
Request Master Symbol Data	<b>M</b>	<K231,?>[for all] or <K231, master symbol number?>
<b>Diagnostics</b>		
Power-on/Resets Counts	<b>K_</b>	<K406,?> returns power-ons,resets>
Hours Since Reset	<b>K@?</b>	<K407?> returns: hours,minutes (read only)
Warning Messages	<b>K"</b>	<K400, warning message status,laser high status,laser low status,novram/reset warning status>
Laser High	<b>K;</b>	<K404, message>
Laser Low	<b>K:</b>	<K405, message>
Present Operating Temperature	<b>K%?</b>	<K408?> returns: deg (read only)
High Temperature	<b>K+</b>	<K402, degrees,message>
Low Temperature	<b>K-</b>	<K403, degrees,message>
Lifetime Hours	<b>K\$</b>	<K401, hours10,message>
<b>Laser Control</b>		
Laser Control		<K700laser on/off,laser framing status,laser off time,laser on time>

## Appendix E — Serial Command Format

Serial commands are of two types: utility and configuration.

### Rules that apply to both utility and configuration commands

1. A less than < and greater than > characters enclose the commands.
2. Commands and data are "case sensitive." That is, characters must be entered as upper or lower case, as specified.

### Serial Utility Commands

These are sent during operations and are not followed by a <A> or <Z>. See [Table 12-1, "Summary of Utility Serial Commands," on page 12-3.](#)

### Serial Configuration "K" Commands

These begin with a single **K** character followed by a 3-digit numeric single character, data fields, and an initializing command, as follows:

**<Knumeric parameter,data,data,...etc.><initializing command>**

An initializing command <A> or <Z> may follow the command. A <Z> initializes the scanner's memory and saves for power-on; an <A> initializes the scanner's memory but does not save for power-on.

For example, to enable **UPC** and save the change for power-on, send **<K473,1><Z>**.

To change **Baud Rate** and reset without saving changes for power-on, send

**<K100,a3><A>**.

**Note:** Allow a **1.5** second delay after sending the <A> command before resuming communications.

**Note:** Previous serial commands had alphabetic parameters following the **K** and did not insert a comma before the 1st field, as in **<Kf5>**. The new "numeric" commands include a comma *after* the numeric parameter, as in **<K140,5>**.

#### *Serial Configuration Command Conventions:*

- All data fields (except the last) must be followed by a comma (without a space).
- The following characters cannot be used: , < > NUL.
- All fields preceding a modified field must be included.
- If there is no change in preceding fields, then commas alone can be entered in these fields. For example, if only the last field in the following command is changing, **<K100,a4,1,0,0>** can be entered as **<Ka100,,,,0>**.
- All fields *following* a modified field can be omitted. For example, to change **Baud Rate**, send **<K100,a3>**.

## Concatenating Configuration Commands

Commands can be concatenated (added together) in a single string or data block. For example, **<K145,1><K220,1><K450,1><A>** enables LRC, sets **End of Read Cycle** mode to **New Trigger**, enables **Narrow Margins**, and resets the data buffers (without saving the changes for power-on).

## Serial Command Status Request

To ensure that any command was received and accepted, you can send the **Show Scanner Status** command: **<?>**.

The status of a specific serial command can be requested by entering the command followed by a question mark. For example, send **<K142?>** to request the status of **Postamble**. Commands **<K199?>**, **<K399?>**, **<K499?>**, **<K899?>**, and **<K699?>** are used to request the status of groups of serial commands. Note that there is no comma between the numeric and the question mark.

## Entering Special Characters in Serial Commands

To enter control characters within a serial command, hold down the control key while typing the desired character.

Example: To enter a carriage return and line feed (^M^J), enter **<K141,1,CNTL-m CNTL-j>**

## Entering Special Characters in Embedded Menus

### *Control Characters*

Control characters entered on the command line are displayed in the menu as mnemonic characters, such as: **<CR><LF><NUL><NUL>**.

Press **SP** (the space bar) once, then enter the control character by holding down the control key and simultaneously pressing the desired character. For example to define a line feed, press **SP**, then **Control** and **J** simultaneously. It is displayed as ^J on the command line and as **<LF>** in the menu when the screen is refreshed.

### *To Define a Carriage Return as a Character*

Press **SP**, then **CR**. It is displayed as ^M on the command line and as **<CR>** in the menu when the screen is refreshed.

### *To Define a Space as a Character*

Press **SP** twice. It is displayed as a blank space in the menu when the screen is refreshed. While it appears that nothing has been assigned, the hex value 20 will be sent during data transmission.

### *To Select NUL as the Character*

Press **SP**, then a **0** (zero). It is displayed as **<NUL>** in the menu when the screen is refreshed.

# Appendix F — ASCII Table

Table A-9 ASCII Table with Control Characters

Dec	Hex	Mne	Ctrl	Dec	Hex	Ch	Dec	Hex	Ch	Dec	Hex	Ch
00	00	NUL	^@	32	20	SP	64	40	@	96	60	`
01	01	SOH	^A	33	21	!	65	41	A	97	61	a
02	02	STX	^B	34	22	"	66	42	B	98	62	b
03	03	ETX	^C	35	23	#	67	43	C	99	63	c
04	04	EOT	^D	36	24	\$	68	44	D	100	64	d
05	05	ENQ	^E	37	25	%	69	45	E	101	65	e
06	06	ACK	^F	38	26	&	70	46	F	102	66	f
07	07	BEL	^G	39	27	'	71	47	G	103	67	g
08	08	BS	^H	40	28	(	72	48	H	104	68	h
09	09	HT	^I	41	29	)	73	49	I	105	69	i
10	0A	LF	^J	42	2A	*	74	4A	J	106	6A	j
11	0B	VT	^K	43	2B	+	75	4B	K	107	6B	k
12	0C	FF	^L	44	2C	,	76	4C	L	108	6C	l
13	0D	CR	^M	45	2D	-	77	4D	M	109	6D	m
14	0E	SO	^N	46	2E	.	78	4E	N	110	6E	n
15	0F	SI	^O	47	2F	/	79	4F	O	111	6F	o
16	10	DLE	^P	48	30	0	80	50	P	112	70	p
17	11	DC1	^Q	49	31	1	81	51	Q	113	71	q
18	12	DC2	^R	50	32	2	82	52	R	114	72	r
19	13	DC3	^S	51	33	3	83	53	S	115	73	s
20	14	DC4	^T	52	34	4	84	54	T	116	74	t
21	15	NAK	^U	53	35	5	85	55	U	117	75	u
22	16	SYN	^V	54	36	6	86	56	V	118	76	v
23	17	ETB	^W	55	37	7	87	57	W	119	77	w
24	18	CAN	^X	56	38	8	88	58	X	120	78	x
25	19	EM	^Y	57	39	9	89	59	Y	121	79	y
26	1A	SUB	^Z	58	3A	:	90	5A	Z	122	7A	z
27	1B	ESC	^[	59	3B	;	91	5B	[	123	7B	{
28	1C	FS	^\	60	3C	<	92	5C	\	124	7C	
29	1D	GS	^]	61	3D	=	93	5D	]	125	7D	}
30	1E	RS	^^	62	3E	>	94	5E	^	126	7E	~
31	1F	US	^_	63	3F	?	95	5F	_	127	7F	D

Table A-10 Communication Protocol Commands

<i>Protocol Command (Mnemonic displayed on Microscan menu)</i>	<i>Control Characters (Entered in menu or serial command)</i>	<i>Hex Code</i>	<i>Effect of Command</i>
<i>RES</i>	<i>^D</i>	<i>04</i>	<i>Reset</i>
<i>REQ</i>	<i>^E</i>	<i>05</i>	<i>Request</i>
<i>EOT</i>	<i>^D</i>	<i>04</i>	<i>Reset</i>
<i>STX</i>	<i>^B</i>	<i>02</i>	<i>Start of Text</i>
<i>ETX</i>	<i>^C</i>	<i>03</i>	<i>End of Text</i>
<i>ACK</i>	<i>^F</i>	<i>06</i>	<i>Acknowledge</i>
<i>NAK</i>	<i>^U</i>	<i>15</i>	<i>Negative Acknowledge</i>
<i>XON</i>	<i>^Q</i>	<i>11</i>	<i>Begin Transmission</i>
<i>XOFF</i>	<i>^S</i>	<i>13</i>	<i>Stop Transmission</i>

## Appendix G — Embedded Menus

In addition to **ESP**, you can also use a communications menu such as Microsoft's HyperTerminal™ to establish communication with Microscan's embedded menus.<sup>1</sup>

1. With your host connected to the configuration port, set your host communications settings as follows: **9600**, **7**, **1**, and **Even**.
2. Set **Flow Control** to **None**.
3. Make the communications port selection. (Usually **COM 1** or **COM 2** for desktops and **COM 1** for laptops.)

Upon connection, send a **<D>** command to bring up the main menu.

```
MICROSCAN SYSTEMS, INC.
CONFIGURATION PROGRAM
MAIN MENU
35-559001-18
-----
TOPICS                DESCRIPTION
1) COMMUNICATIONS    HOST PROTOCOL & HOST/AUX PORT CONFIG.
2) OPERATIONS        TRIGGERING, TIMEOUTS, ETC.
3) CODE TYPES 1      CODE 39, I 2 OF 5, CODE 128, CODE 93
4) CODE TYPES 2      CODABAR, UPC
5) GLOBAL CODE PARAMETERS MARGINS, SYMB.ID., & BACKGROUND
6) SCANNER I/O       PROGRAMMABLE I/O
7) SCANNER OUTPUT    BEEPER, LASER, OUTPUT MODES, ETC.
8) SCANNER SETUP     FACTORY AND VIDEO SETTINGS
9) DIAGNOSTICS SETUP WARNING MESSAGES, OPERATION TIME, ETC.
10) OMR              OMR SETUP & CALIBRATION DATA
-----
ESC = MAIN MENU OR EXIT  N = NEXT ITEM
M  = PREVIOUS MENU      SP = NEXT ITEM
B  = PREVIOUS ITEM      CR = THIS ITEM
-----
MAIN--> COMMUNICATIONS_
```

4. Press the return key (**CR**) to see the communications menu:

Menu navigation commands are case sensitive. Use the space bar or N to advance to the next item, CR (return key) to select a highlighted item, B to return to the previous item, M to return to the previous menu, and ESC to return to the Main menu or to exit the program. When exiting the program, you will be prompted to save your active settings for power up (Y or N). Typing Y will be equivalent to saving with a **<Z>** command.

1. If you are using Microsoft's HyperTerminal program, you may find that the initial screen is unviewable when you call up the program with the **<D>** command. If this occurs, simply exit the embedded menu with a **ESC**, **E**, and **N** sequence and repeat the **<D>** command.

## Appendix H — Defaulting/Saving/Initializing

**Active Memory** is where the scanner's settings are stored during current use and are initialized by an **<A>** command.

Microscan **Defaults** are where the scanner's default application/boot programs are stored. They can only be changed by changing the application/boot codes.<sup>1</sup>

**User-Saved Settings** are where user-defined settings are saved for power-on.

### Defaulting

**Defaulting** occurs when default settings (either Microscan or user-saved) are restored. Defaulting might be necessary if you have to make temporary changes, communications between the scanner and another device are lost or interrupted, or you are using incompatible equipment (for example, a terminal that is set at 9600 baud communicating with a scanner that is set at 38.4K baud).

#### Restore User-saved Settings to Active Memory

- Restores user-defined settings to active memory.
- Initializes serial configuration commands in active memory and resets counters to zero.

##### By Serial Command

Send **<An>** command to the scanner.

By ESP (There is no equivalent ESP command.)

#### Restore Microscan Defaults to Active Memory

- Restores Microscan defaults to active memory.
- Initializes serial configuration commands in active memory and resets counters to zero.
- Does not save settings for power-on.

##### By Serial Command

Send **<Ad>** command to the scanner.

By ESP

**Right-click** in the configuration window and select **Default all ESP Settings**.

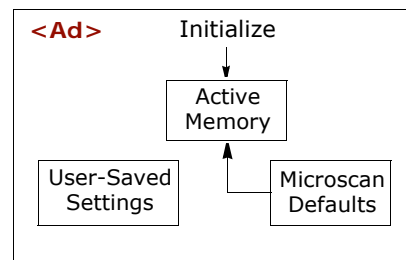
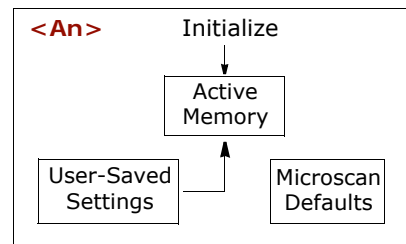

1. See your Microscan sales representative to access the latest application codes.

## Defaulting/Saving/Initializing

### Restore Microscan Defaults to Active Memory and for Power-on

**Caution:** Defaulting the scanner to Microscan default settings will overwrite user-saved settings.

- Restores Microscan defaults to memory.
- Restores Microscan defaults to user-saved settings for power-on.
- Initializes serial configuration commands in active memory and resets counters to zero.

#### By Serial Command

Send **<Zd>** command to the scanner.

#### By ESP

1. **Right-click** in the configuration window and select **Default all ESP Settings**.
2. **Right-click** and select **Save to Reader** and **Send and Save**.

#### By Hardware Default

If a software default reset is not possible, it may be necessary to reset the scanner by shorting (connecting) specific pins. This procedure has the same effect as the **<Zd>** software command.

1. Apply power to the scanner.
2. If using an IB-131, locate pins 7 and 11 on the host connector. (see **"IB-131 Interface Module" on page A-10**).

**Caution:** Be certain that the correct pins are located. Connecting the wrong pins could cause serious damage to the unit.

3. Momentarily connect these wires (or pins) and listen for a series of short beeps.
4. Within 3 seconds, connect them again. A longer beep should be heard. If not, repeat the process.

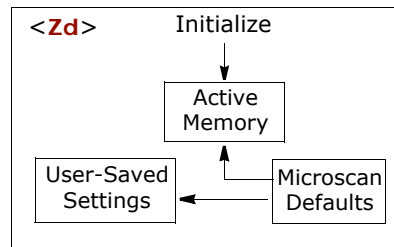



## Saving

**Power-on** settings are those that are saved by a **<Z>** or **<Zp>** command and are loaded into active memory whenever power to the scanner is recycled.

### *Save Active Settings, except Factory, for Power-on*

- Initializes serial configuration commands into active memory and resets counters to zero.
- Saves all current settings except factory settings to user-saved settings for power-on.

#### *By Software Command*

Send **<Z>** command to the scanner.

#### *By ESP*

**Right-click** in the configuration window and select **Save to Reader**, then **Send and Save**.

**Note:** Allow a **1.5** second delay after sending the **<A>** command before resuming operations.

### *Save Only Factory Settings for Power-on*

- Initializes serial configuration commands in active memory and resets counters to zero.
- Saves all factory settings for power-on (factory settings include but are not limited to Focus, Gain, Tracking, and Scan Speed).

#### *By Serial Command*

Send **<Zp>** command to the scanner.

#### *By ESP*

**Right-click** in the configuration window and select **Save to Reader**, then **Send and Save, Including Factory**.

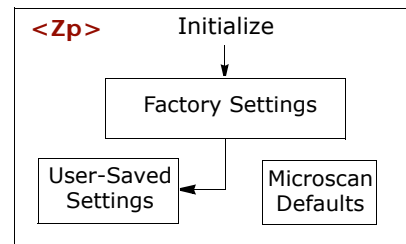
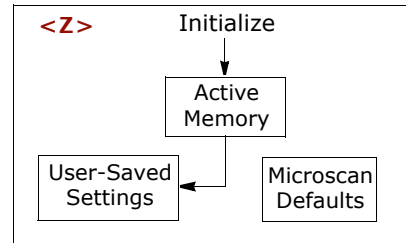

## Initializing

---

**Initializing** occurs whenever any command or set of commands is implemented.

Initializing is a part of all save and default functions. It is also used as a follow-on to implement serial configuration commands.

- Initializes serial configuration commands into active memory and resets counters to zero.
- Does not save settings for power-on.

### *By Serial Command*

Send **<A>** after a serial configuration command or a string of serial configuration commands, for example, **<K141,d1><A>**.

### *By ESP*

**Right-click** in the configuration window and select **Save to Reader, Send No Save**.

This will initialize all serial configuration changes that have been made in the current ESP session.

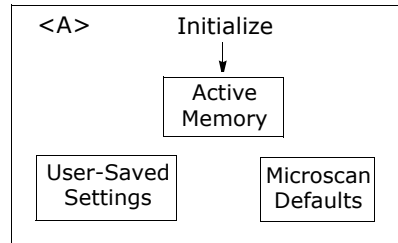

## Loss of Communications

---

Making changes to communications with the host such as **Baud Rate, Parity, Stop Bits, LRC**, etc. without corresponding changes in linked device(s) can result in the loss of menu access through If this should occur, you should restore the scanner's defaults. (See "**Defaulting**" on page A-21.)

# Appendix I — Test Decode Rate

## By Bar Code Configuration

---

You can enter the read rate test by scanning the following symbols:

To enable Bar Code Configuration, scan this symbol:



(This will also activate the read performance LED's on the scanner.)

To enable all symbologies, scan the following:



To start your read rate test, scan this symbol:



You should now be able to read any enabled symbol.

To end the read rate test and the bar code configuration program, scan this symbol:



This will terminate the bar code configuration mode. Changes made in configuration will remain in effect, as would changes made in the menus or by serial commands.

## By Serial Command

---

1. Position a stationary symbol in front of a functioning scanner at the scan distance used in your application.
2. Enter a **<C>** command to see the decodes per second.  
The decode rate is the number of decoded scans per total number of scan. It will appear at the beginning of the data strings.  
**Note:** You can also enter a **<Cp>** command to see the percentage of decodes per scans.
3. Make a note of the decode rate. You will need this when calculating the number of decodes (see **"Formulas for Number of Decodes" on page A-27**).
4. End the test by sending the **<J>** command.

## By ESP

---

See **"Read Rate" on page 12-5**.

## Testing with a Moving Symbol

Before testing with a moving symbol, it is highly recommended that you calculate the expected number of decodes by using the formulas in **"Formulas for Number of Decodes" on page A-27**.

Once you've mounted the scanner, established a good read rate with a stationary symbol, and calculated the number of decodes for your symbol speed, you can begin decoding with moving symbols.

## Number of Decodes

To ensure reliable scanning, you need to apply a minimum of five decodes to each symbol. This means that all variables, symbol speed, read range, etc. are significant.

**Note:** Variations between symbols are common. For this reason, the greater number of sample symbols tested, the more likely you are to achieve optimum decode rates.

In general, the number of decodes of a given symbol can be increased by:

- Increasing symbol height
- Decreasing symbol length
- Increasing scan rate (spinning mirror speed)
- Slowing symbol speed

## Appendix J — Formulas for Number of Decodes

To ensure reliable scanning, the scanner should apply a minimum of *five* scans to each symbol. Use the formulas below to predict the number of decodes that your symbol will receive.

If the number of decodes you derive from one of these calculations is less than the minimum, plug in the minimum number of decodes (5) and solve for another parameter that might be changed such as symbol speed or scans per second.

**Note:** While the formulas given here solve for the predicted number of decodes, you may also use the formulas to solve for other parameters that might be changed, such as symbol speed, symbol length, etc.

### Single Line Ladder Calculation

For single scan line ladder scanning, use the following formula:<sup>1</sup>

$$ND = \left( \frac{SH}{SS} \times DR \right) - 3$$

**ND** (*Number of Decodes*) is the number of decodes that a given symbol can be expected to achieve in a given application.

**SH** (*Symbol Height*) is a measurement of the height of individual bars.

**SS** (*Symbol Speed*) is the distance per second that a symbol moves through the scan.

**DR** (*Decode Rate*) is the number of scans per second that a given symbol receives (as derived from a stationary scan test in [“Test Decode Rate” on page A-25](#)).

*Example:*

SH = 1 inch

SS = 100 inches per second       $ND = \left( \frac{1}{100} \times 900 \right) - 3 = 6$  complete decodes

DR = 900 decodes per second

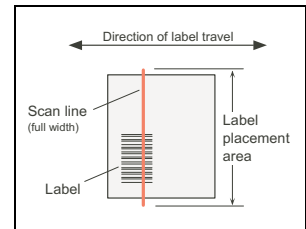

Figure A-9 Ladder

1. The -3 component in the formula is included to allow for AGC acquisition, an incomplete first scan, and an incomplete last scan. This applies only if the number inside the parentheses equals 4 or more. If the number equals 3, then only subtract 2 to derive 1 good scan.

## Single Scan Line Picket Fence Calculation

For single scan line picket fence scanning (**Top Offset** setting equal to **Bottom Offset**), use the following formula:

$$ND = \left( \frac{(SW - SL)}{SS} \times DR \right) - 3$$

**ND** = Number of Decodes (total per symbol)

**SW** = Scan Width

**SL** = Symbol Length

**SS** = Symbol Speed

**DR** = Decodes rate.

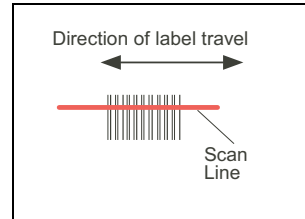

Figure A-10 Picket Fence

*Example:*

SL = 2 inches (including quiet zones)

SS = 100 inches per second

SW = 4 inches

DR = 1000 decodes per second

$$\left( \frac{(4 - 2)}{100} \times 1000 \right) - 3 = 17 \text{ complete decodes}$$

## Angled Picket Fence Calculation

The number of complete scans for angled picket fence is calculated the same as that for picket fence, with the exception that the scan width is shortened in proportion to scan tilt.



Figure A-11 Angled Picket Fence

---

## *Improving the Number of Decodes*

---

After changing any of the parameters described here, recalculate number of decodes.

### Scan Speed

Scan speed is a function of motor speed and is adjustable. A slower scan rate may allow greater symbol range and/or higher decode rates, but at the cost of a lower decode rate scans. When you lower scan speed, you lower the decode rate.

### Range

Adjusting the symbol's range, if possible, is one of the quickest and most effective ways to improve decode rates. However, in some applications you may need to select a less than optimum range, or one that is beyond the fringes of the ranges.

### Scan Width

Increasing scan width will increase the number of scans in a picket fence oriented application. Scan width is linked with scan range and changing one will usually require a change in the other.

### Symbol Speed

Applies to both picket fence and ladder oriented symbols. If your application allows it, slowing symbol speed (the time in seconds that a symbol is fully within the scan width of the scanner) is an effective way to increase the number of decodes.

### Laser Framing

Narrowing the laser frame may not increase the decode rate, but it will minimize the opportunity of extraneous reads.

### Symbol Dimensions, Symbol Density, and Symbol Ratio

Not usually an option in most applications, but changes to symbol parameters can affect number of decodes calculations and possibly decode rates.

If your application allows, shortening the length of a picket fence symbol means the symbol will be in the read range longer and hence receive a greater number of scans.

Increasing the height of a ladder symbol means it will receive more scans. Changing symbol density and/or symbol ratio is another way ranges, decode rates can be altered.

### Gain

This adjustment, typically made by qualified technicians, is referenced in the Scanner Setup menu under Read Cycle. (See ["Scanner Setup" on page 4-17.](#))

## Appendix K — Operational Tips

### Do:

- Check inputs (symbol speed, length, height, etc.) to ensure the desired number of decodes per symbol.
- For optimum decodes, mount scanner so that your symbols pass through the center of the depth-of-field (minimum/maximum range). You find the center by moving your symbol in and out during a read rate test.
- Avoid excessive tilt, pitch, and skew of the bar code symbol.
- Check the bar code symbol for readability by doing a decode rate test. If there is any question about the symbol's readability, contact your Microscan representative at [helpdesk@microscan.com](mailto:helpdesk@microscan.com).
- After changing any parameter that might affect decode rate, repeat decode rate test.
- Clean the scanner window with a clean, dry Q-tip or cotton cloth on a regular basis.

### Do Not:

- Aim the scanner into direct light or sunlight.
- Aim the scanner into an external object detector or other light-emitting device.
- Obstruct the scanner window with mounting hardware or other objects.
- Connect chassis of scanner and host to different ground potentials.
- Operate the scanner in excessive temperature environments.



## *Appendix L — Interface Standards*

Interface Standards, established by the Electronic Industries Association (EIA), specify such things as the signaling voltage levels, maximum cable lengths, and number of drivers. With Microscan devices, selection of interface is made by pin assignment and, in the case of the host communications, by software switching between RS-232 and RS-422. Microscan devices use RS-232, RS-422, and RS-485 multidrop.

### **RS-232**

RS-232 defines an interface between two devices, such as the scanner and host. It differs from the other interfaces by dedicating individual pins to specific functions and by requiring both devices to share a common ground line. Since both device chassis are connected to a common ground, a ground loop potential and the possibility of noise interference exists; therefore, cable lengths are limited to a maximum of 50 feet (19.7m). Despite being the most limited, this interface is used frequently because of the large installed base of RS-232 equipment.

### **RS-422**

RS-422, unlike RS-232, measures signals differentially; that is, the receiver looks at the potentials between the two receive (or transmit) wires rather than the potential between signal and ground. As a result, cables, if shielded, can be up to 4000 feet (1219m) in length. Like RS-232, RS-422 communication is designed for only two devices on a single line and must have a common ground. It can be used wherever RS-232 is used.

### **RS-485**

RS-485, like RS-422, can transmit up to 4000 feet (1219 m) using differential voltages, but unlike RS-422, its transmitters are turned off until a request for data is received from the host. RS-485 is used exclusively in multidrop protocol.

# Appendix M — Multidrop Communications

This appendix describes the rules for setting up a concentrator or controller to communicate with a scanner in standard Multidrop protocol.

The diagram to the right shows a typical Multidrop network in which 1 to 50 scanners can communicate with a host via an intermediary device, a concentrator or a controller.

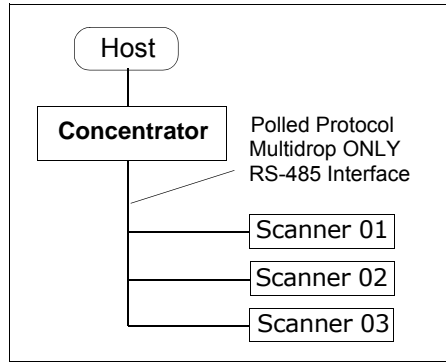

## Configure the Scanner for Multidrop

1. With the scanner connected to the host, do **Retrieve Scanner Settings**.
2. Select **Multidrop** in the **Protocol** configuration menu.

You will see the following message:

**Important.** You must change your preamble and postamble characters so that they are not CR or NULL.

This allows data to move through the concentrator without interference.

3. Click **OK**.
4. Next, go to **Preamble Characters** (still in the **Protocol** menu) and double-click on **Characters**.
5. This will open up an ASCII character table. Select any character other than **CR**. For example, select **LF**.
6. Repeat the above for **Postamble**.
7. Check the multidrop address. Enter a number from **01** to **50**.
8. Right-click in the window and select **Save to Reader** and **Send and Save**.
9. Your scanner is now in multidrop. From here on, you will need to use the concentrator to relay commands and data between the scanner or scanners and the host.
10. Next, go to **“Connect to Scanner via the Concentrator”** on page A-33.

Parameters	ESP Values
Communications	
RS232/422 Host Port	
Host Port Connections	
Baud Rate	9600
Parity	Even
Stop Bits	One
Data Bits	Seven
Host Protocol	Point-to-Point*
Host 422 Status	Point-to-Point*
RS232 Auxiliary Port	Point-to-Point with RTS/CTS
Preamble	Point-to-Point with XOn/XOff
Postamble	Point-to-Point with XOn/XOff and P
Polling Mode D	
LRC	Multidrop
Response Timeout	User Defined
Intercharacter Delay	User Defined Multidrop

## Connect to Scanner via the Concentrator

You will need a multidrop concentrator and the required power supplies and cabling to communicate with your scanner(s).

1. From the **Communications** drop down menu, select **Configure Multidrop** to bring up the **Multidrop Settings** dialog.
2. If necessary, change the default address to match the address of your multidropped scanner and click **OK**.

If the host serial port is not connected in ESP, you will see the following popup message:

*ESP is not currently connected to the multidrop concentrator. Do you wish to establish a connection now?*

3. Click **Yes**.

You will see a **Serial Communication Parameters** dialog as shown.

Notice that the **Force Connection** option is checked. Do not change this.

4. Select the concentrator's host port communications settings.

When you click **Connect**, you will be connecting to your concentrator, which can then relay commands to the scanner whose address was set in the **Multidrop Settings** dialog.

5. Click **Connect**.
6. You should see the **CONNECTED** message in green at the bottom of the window along with the scanner's **Multidrop** address.



7. Click **Retrieve Scanner Settings** to upload scanner's configuration. If upload fails, return to the **Serial Communication Parameters** dialog and make the corrections.
8. Follow the same procedure for connecting other scanners to your multidrop network.

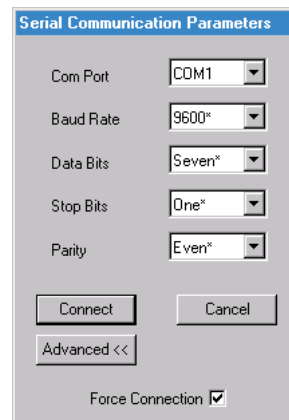
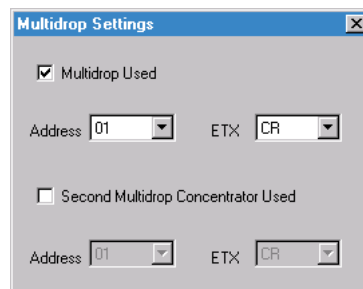

## Polling Sequence

Data that is transmitted to the host (symbol data, noread messages, counters, etc.) via concentrators is solicited by poll requests from the host.

The polling sequence example is by poll address 1E (ASCII hex value for Scanner 02) and a REQ (request). The scanner responds by first transmitting its own address, 1E, followed by a STX (start of text) character, and then the data. Next it transmits an ETX (end of text) character and an LRC (longitudinal redundancy check) character.

If the concentrator (or controller) receives the data from the scanner and is able to validate it with an LRC calculation, it responds with an ACK (acknowledgment). If the scanner in turn receives the ACK, the scanner ends this exchange with a RES (reset).

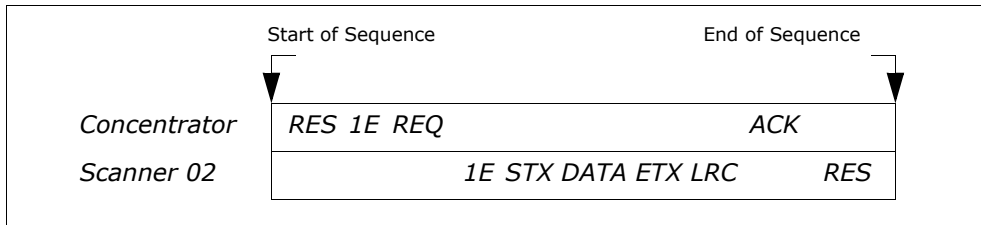

Figure A-12 Polling Sequence

### Polling Reset

- If the scanner has no information, it responds to a poll request by transmitting a RES (reset).
- If the scanner receives a NAK instead of the ACK after transmitting its data string, it will re-attempt to send the data string up to three times. If the scanner still does not receive an ACK, it will send a RES (reset) and discard the data in its buffers.
- If the scanner transmits data to the concentrator and the concentrator responds with an ACK or NAK, but the scanner doesn't receive the concentrator's response, the scanner will timeout and send a REQ to the concentrator and request another response. If after three retries (the number of times it transmits a REQ to the concentrator) the scanner receives no response, it ends the transmission with a RES (reset).

## Select Sequence

Unlike poll requests, select commands always originate from the host and consist of serial configuration or operation commands to devices that are configured in Multidrop. The scanner complies with the command when it is polled during the cycle.

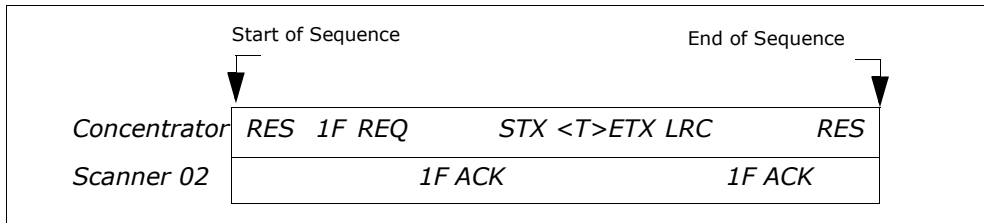

Figure A-13 Polling Sequence

A RES (reset) is the first command in the select sequence. The 1F hex is the select address associated with Scanner 02 address. It is followed by a REQ (request). The scanner responds with its own select address, 1F hex, and an ACK (acknowledge). The concentrator then transmits an STX (start of text), the data (in this case a <T>), an ETX (end of text), and an LRC character.

The scanner replies by transmitting its own address, followed by an ACK, acknowledging receipt of the command. Upon receipt of an ACK, the concentrator concludes the successful exchange with a RES.

In the example above, the scanner only acknowledges a trigger counter request from the concentrator. It does not respond to the trigger counter request until a subsequent poll. For example, if the scanner's trigger count was 12 at the time the trigger counter request was received, on a subsequent poll it would send 02T/00012. (The 02 at the beginning of the string is the scanner's address.)

### Select Reset

If the scanner receives bad data from the concentrator, it transmits a SEL (its select address) and a NAK to the concentrator. The concentrator re-transmits the data up to three times. The concentrator will end the sequence with a RES (reset) if no ACK is received.

Table A-11 Multidrop Addresses

Multidrop Address	Poll Character		Select Character		Multidrop Address	Poll Character		Select Character	
	ASCII	HEX	ASCII	HEX		ASCII	HEX	ASCII	HEX
01	^\	1C	^]	1D	26	N	4E	O	4F
02	^^	1E	^-	1F	27	P	50	Q	51
03	SP	20	!	21	28	R	52	S	53
04	"	22	#	23	29	T	54	U	55
05	\$	24	%	25	30	V	56	W	57
06	&	26	'	27	31	X	58	Y	59
07	(	28	)	29	32	Z	5A	[	5B
08	*	2A	+	2B	33	\	5C	]	5D
09	,	2C	-	2D	34	^	5E	_	5F
10	.	2E	/	2F	35	`	60	a	61
11	0	30	1	31	36	b	62	c	63
12	2	32	3	33	37	d	64	e	65
13	4	34	5	35	38	f	66	g	67
14	6	36	7	37	39	h	68	i	69
15	8	38	9	39	40	j	6A	k	6B
16	:	3A	;	3B	41	l	6C	m	6D
17	<	3C	=	3D	42	n	6E	o	6F
18	>	3E	?	3F	43	p	70	q	71
19	@	40	A	41	44	r	72	s	73
20	B	42	C	43	45	t	74	u	75
21	D	44	E	45	46	v	76	w	77
22	F	46	G	47	47	x	78	y	79
23	H	48	I	49	48	z	7A	{	7B
24	J	4A	K	4B	49		7C	}	7D
25	L	4C	M	4D	50	~	7E	D	7F

## Appendix N — Glossary of Terms

**Active Closed.** An optoisolated input that's logically "on" when current flows through the connection points.

**Active Open.** An optoisolated input that's logically "on" when *no* current flows through the connection points.

**Analog Gain Adjustment (AGC).** Adjustment to signal strength that seeks to maintain a constant level regardless of the range of the symbol.

**Application Record.** A variation of UCC/EAN-128 which adds an application identifier to symbol data, including user-definable separators, brackets, and padding.

**Autodiscriminate.** The ability to decode several different symbologies without changing configuration.

**Auxiliary Port.** Provides RS-232 connections to an auxiliary terminal or device for remote viewing, for the transfer of data to and from the host, and under certain conditions as a configuration port.

**Bar Code.** The medium or symbol on which a symbol is printed or etched.

**Bar Code Data.** The information that is transmitted from a decoded bar code symbol.

**Baud Rate.** The number of discrete signal events per second. Bits per second.

**Capture.** The act of grabbing or recording a frame by a sensor. A frame or succession of frames that are captured.

**Check Digit.** A Modulus 43 or Modulus 10 dgit that is added to the symbol message for additional data integrity.

**Configuration.** A setup or process of changing a scanner's settings to conform to a specific application. A physical arrangement of components.

**Concentrator.** Intermediary device that relays data from scanners to a host and commands from the host to the scanner or other devices.

**Connector.** Physical device (plug or socket) on a device or cable to provide in/out connectivity for various circuits and pins.

**Counter.** Memory space provided to keep track of scanner events.

**Daisy Chain.** Linkage of master and secondary scanners to allow data to be relayed up to the host via auxiliary port connections.

**Decode.** A good read. The successful scanning and decoding of the information encoded in symbol.

**Default.** (verb) Restore Microscan or customer default settings, initialize serial commands and reset all counters.

**Defaults.** (noun) The settings that are restored whenever a default takes place.

**Delimited.** A command or field that is bracketed by pre-defined characters.

**Decode Rate (DR)** The number of decodes per second that a given scanner is capable of receiving.

**Depth of Field.** The distance between the minimum and maximum range in which symbols have been read.

---

## Glossary of Terms

**Discrete I/O.** Inputs and outputs characterized by discrete signal transitions from one voltage level to another so that digital switching can occur.

**Dynamic Setup.** Testing and configuration done with symbols in motion.

**EPROM.** Erasable, programmable, read only memory.

**Embedded Memory.** Onboard memory device such as EPROM or flash.

**End of Read Cycle.** The time or condition at which the scanner stops expecting symbol information to decode.

**Edge.** Allows a read cycle to be initiated by a trigger signal from an object detector when it detects the appearance of an object (rising edge). The read cycle ends with a good read, a timeout, or a new trigger.

**ESP.** Easy Setup Program. A portable proprietary Windows/NT based program developed by Microscan Systems, Inc.

**Falling Edge.** A change of state (to inactive) associated with a level trigger in which the scanner stops searching for symbols. (See **Rising Edge.**)

**Fixed Code Length.** Increases data integrity by ensuring that only one symbol length will be accepted.

**Flash Memory.** Memory that can be changed by downloading new code and recalled on power-on.

**Focal Length.** The distance measured from the scanner to the center of the depth of field, or *focal* point.

**Focus.** The point at which the tip of the scan beam is at its narrowest.

**Full Duplex.** Auxiliary port data is sent directly to the host but not displayed on the auxiliary port screen.

**Gain.** Optimal signal strength.

**Good Match.** The event occurring when a scanned symbol matches the master symbol information that is stored in the memory of the device.

**Good Read.** A decode. The successful scanning and decoding of the information encoded in a symbol.

**Half Duplex.** Auxiliary port data is sent directly to the host and displayed on the auxiliary port screen.

**Host.** A computer, PLC, or other device that is used to execute commands and process data and discrete signals.

**Host Port.** The pins or connections on a scanner or other device that physically connect with a host and—using the RS-232, RS-422, or RS-485 standards—pass data and serial commands from one device to another.

**Initialize.** Implement serial configuration commands into the scanner's active memory.

**Input.** A channel or communications line. Decoded data or a discrete signal that is received by a device. See **Output.**



**Intercharacter Delay.** The time interval in milliseconds between individual characters transmitted from the scanner to the host.

**Intercharacter Gap.** The extra space between the last element of one character and the first element of the adjacent character of a specific bar code symbol.

**Ladder Symbol Orientation.** A bar code symbol in which the bars are parallel to the symbol's direction of travel.

**Large Intercharacter Gap.** Allows the scanner to read symbols with gaps between symbol characters that exceed three times (3x) the narrow element width.

**Laser Framing.** Setting scan width size by adjusting the on/off duration of the laser beam.

**Laser On/Off.** When enabled, the laser is ON only during the read cycle, provided the scanner is enabled for a Serial or External trigger.

**LED.** Light emitting diode.

**Level.** The condition in which a read cycle initiated by a trigger signal from an object detector remains active and ends when the object moves out of the detector's range.

**Longitudinal Redundancy Check (LRC).** An error-checking routine that verifies the accuracy of transmissions.

**Master Symbol.** A symbol or symbol data that is stored in a scanner or scanner's memory and is compared with subsequently read symbols.

**Master Scanner.** First scanner in a daisy chain mode and linked directly to the host and in tandem to secondary scanners.

**Matchcode.** The ability to compare symbol data being scanned against a master symbol that is stored in the memory of the scanner.

**Embedded Menu.** Configuration options embedded in the scanner's erasable memory.

**ESP Menu.** Easy Setup Program. Configuration program that runs in Windows-based operating systems 95 and above.

**Mil.** One thousandths of an inch or 0.0254 mm. In bar-coding, a measurement standard that identifies a symbol by the width of its narrowest element.

**Mismatch.** An event that occurs when the scanned symbol does not match the master symbol that is stored in the memory of the scanner.

**Multisymbol.** A scanner mode which allows a scanner to read more than one symbol in a single read cycle.

**Multidrop.** A communications protocol for networking two or more scanners or other devices with a concentrator (or controller) and characterized by the use of individual device addresses and the RS-485 standard.

**Narrow-bar-width.** The width of the narrowest bar of a specific bar code symbol, expressed in thousands of an inch (or mils) as defined by standard code types.

**Narrow Margins.** Allows the scanner to read symbols with quiet zones less than 8 times the width of the narrow bar element.

**Non-delimited.** A command that is not bracketed by pre-defined characters.

---

## Glossary of Terms

**Noread.** A non-read. A condition that occurs when the scanner is set up to decode symbols but no symbol is scanned during the read cycle.

**Normally Closed.** A discrete output state that is only active when open.

**Normally Open.** A discrete output state that is only active when closed.

**NOVRAM.** Non-volatile random access memory. Data that is "saved for power-on" is saved to NOVRAM.

**Null.** Also spelled "Nul." A non-printed ASCII character that acts as a space-holder.

**Number of Decodes.** The number of times a symbol is scanned by the scanner during one pass through the laser beam.

**Object Detector.** A photo electric device used to sense the presence or absence of an object (also referred to as a package detector).

**Output.** A channel or communications line. Data or discrete signals that are transmitted or displayed by a device.

**Output Format.** The modification of data output according to a user-defined index of **Extraction** and **Insertion** commands.

**Parity.** An error detection routine in which one data bit in each character is set to 1 or 0 (zero) so that the total number of 1 bits in the data field is even or odd.

**Picket Fence Symbol Orientation.** A bar code symbol in which the bars are perpendicular to the symbol's direction of travel.

**Pitch.** Symbol (or scanner) rotation around the center of a line parallel to the scan beam.

**Point-to-Point.** A protocol consisting of a single communications event, typically used to connect a bar code scanner to a terminal or host computer.

**Port.** Logical circuit for data entry and exit. (One or more ports may be included within a single connector.)

**Protocol.** The rules for communication between devices, providing a means to control the orderly flow of information between linked devices.

**Quiet Zones.** Specified "clear" (non printed) areas immediately before and after the bar code symbol. The area is usually white (for black and white symbol) and at least 10 times the width of the narrowest bar, as measured in thousands of an inch. The zones can be other than white as long as their densities remain consistent and they have the required contrast relative to the bars.

**RAM.** (Random Access Memory) Memory that is lost after power is recycled to the unit.

**Raster.** Multiple, stacked scans produced by a separate oscillating mirror or by a spinning mirror with varying facet angles.

**Read Cycle.** A programmed period of time or condition during which the scanner will accept symbol input.

**Scanner.** (1) A scanner. A bar code device that can read and decode symbols.  
(2) A device that reads and decodes 2D matrix codes.

**Read Range.** The distances in which a symbol can be reliably read, as measured from the front of the scanner. See "Depth of Field."

**Reed-Solomon Error Correction Code.** A linear, error correcting block code, suited to the correction of character errors which could be, in bar or matrix codes, the obliteration or removal of part of the symbol.

**Read Range.** The distances in which a symbol can be reliably read, as measured from the front of the scanner. See "Depth of Field."

**Relay.** An electrical switch that allows a low power to control a higher one.

**Reset.** Sets all counters to zero.

**Rising Edge.** A change of state (to active) that initiates (and in some cases ends) a read cycle with a new trigger, an edge trigger, or the leading edge of a level trigger. (See **Falling Edge**.)

**ROM.** (Read Only Memory) Memory that cannot be changed.

**Scanner.** A reader. A scanning device that is comprised of a scan head and a decoder integrated in one package.

**Scan Speed.** The number of scans per second that a scanner projects from the spinning mirror.

**Scan Width (SW)** is the width across the scan beam at a given distance from the scanner in which a symbol can be read.

**Secondary Scanner.** A scanner linked to the master or preceding scanner in a daisy chain which relays symbol data to the host. See "Daisy Chain."

**Send.** Transmit data from one device to another.

**Separator.** A character that separates data fields.

**Serial Commands.** Online data strings such as <D> or <P> sent from a host or auxiliary terminal to a scanner or other device.

**Serial Configuration (Host Configuration).** Serial commands that change configuration; distinguished from operational command by the fact that they can modify non-volatile memory for power-on configuration.

**Skew.** Symbol (or scanner) rotation around the center of the skew axis which is perpendicular to the plane of the scan beam.

**Specular Reflection.** The direct, mirror-like reflection of light back to the source causing saturation and bad reads.

**Supplemental.** A character or data string that is appended to the main bar code symbol.

**Symbol.** A one or two dimensional decodable pattern that can be recognized and decoded by a bar code scanner or 2D reader.

**Symbology.** A code type, such as Code 39 or Code 128 with special rules to define the widths and positions of bars and spaces to represent specific numeric or alphanumeric information.

**Symbol Density.** Symbol size as measured by the narrow bar width.

**Symbol Height.** (SH) Regardless of orientation, the measurement taken along the length of a symbol's individual bars.

**Symbol Length.** (SL) Regardless of orientation, the measurement taken across the symbol's bars from one end to the other, including the quiet zone.

**Symbol Speed.** (SS) the distance per second that a symbol moves in a dynamic appli-

---

## *Glossary of Terms*

cation.

**Symbol Transitions.** The transition of bars and spaces on a symbol, used to detect the presence of a symbol on an object.

**Tilt.** Symbol (or scanner) rotation around the centerline of the scan beam.

**Timeout.** The termination of a read cycle or other routine by time.

**Timeout Duration.** The actual time that elapses during a read cycle or other timed routine.

**Tracking.** Adjustment of the precision of analog-to-digital conversion.

**Transmit.** Send or convey signals or information from one device to another.

**Transparent.** Data that passed between the auxiliary port and the host with keyed data echoed to the auxiliary port

**Trigger.** A signal, transition, or character string that initiates a read cycle.

**Watchdog Timer.** A security device that detects system crashes and attempts to reset the scanner.

**Watchdog Reset.** A reset that is forced whenever the software locks up.

**Wild Card.** User-defined character entered into a master symbol to permit matches with variable characters.