

RS5100

Bluetooth Ring Scanner

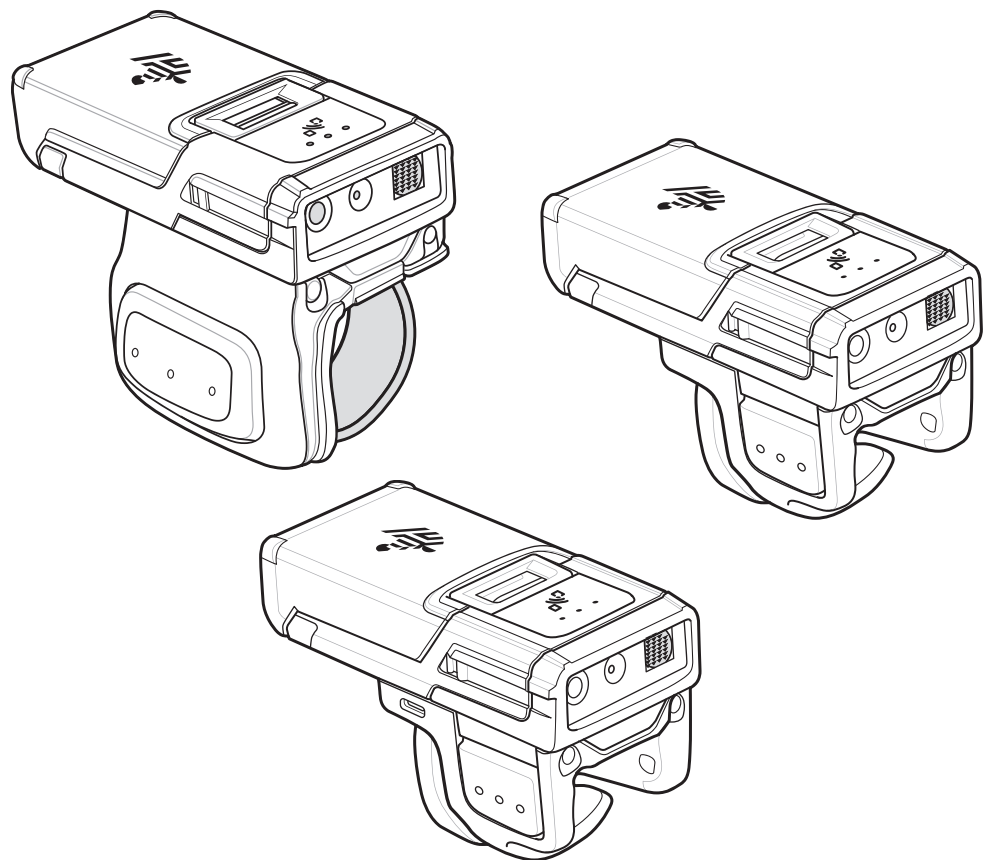

Product Reference Guide



ZEBRA

Copyright

ZEBRA and the stylized Zebra head are trademarks of Zebra Technologies Corporation, registered in many jurisdictions worldwide. All other trademarks are the property of their respective owners.

© 2024 Zebra Technologies Corporation and/or its affiliates. All rights reserved.

Information in this document is subject to change without notice. The software described in this document is furnished under a license agreement or nondisclosure agreement. The software may be used or copied only in accordance with the terms of those agreements.

For further information regarding legal and proprietary statements, please go to:

SOFTWARE: zebra.com/linkoslegal

COPYRIGHTS: zebra.com/copyright

PATENTS: ip.zebra.com

WARRANTY: zebra.com/warranty

END USER LICENSE AGREEMENT: zebra.com/eula

Terms of Use

- Proprietary Statement

This manual contains proprietary information of Zebra Technologies Corporation and its subsidiaries (“Zebra Technologies”). It is intended solely for the information and use of parties operating and maintaining the equipment described herein. Such proprietary information may not be used, reproduced, or disclosed to any other parties for any other purpose without the express, written permission of Zebra Technologies.

- Product Improvements

Continuous improvement of products is a policy of Zebra Technologies. All specifications and designs are subject to change without notice.

- Liability Disclaimer

Zebra Technologies takes steps to ensure that its published Engineering specifications and manuals are correct; however, errors do occur. Zebra Technologies reserves the right to correct any such errors and disclaims liability resulting therefrom.

- Limitation of Liability

In no event shall Zebra Technologies or anyone else involved in the creation, production, or delivery of the accompanying product (including hardware and software) be liable for any damages whatsoever (including, without limitation, consequential damages including loss of business profits, business interruption, or loss of business information) arising out of the use of, the results of use of, or inability to use such product, even if Zebra Technologies has been advised of the possibility of such damages. Some jurisdictions do not allow the exclusion or limitation of incidental or consequential damages, so the above limitation or exclusion may not apply to you.

Revision History

Changes to the original guide are listed below:

Revision	Date	Description
-13	04/24	Updated: Aiming the RS5100 description Parameter # 1368 description Table 9: User Preferences Parameter Defaults Table 27: Standard Default Parameters Battery Indications section in Table 1: System LED Indications
-12	03/24	Added: 2-Bay Charger information. Bluetooth Adapter information. BLE Beacons information and parameter descriptions.
-11	09/23	Obsolete
-10	09/22	Updated Hand Mount information.
-09	01/22	Added HID CAPS Lock Override parameter. Revised Multipoint-to-Point communication description.
-08	11/21	Added Enterprise Hand Mount.
-07	02/21	Added note to battery indications.
-06	12/20	Replaced Master/Slave references with Central/Peripheral.
-05	08/20	Enhanced. documentation for support with STB3678.
-04	05/20	Added Double-Tigger: USB-C and Double-Trigger: Vibrator.
-03	04/20	Added Double-Trigger: Standard and Extended Battery.
-02	03/20	Added Auto Un-Pairing.
-01	11/19	Initial Release

About This Guide

Introduction

The RS5100 Ring Scanner, also referred to as the Bluetooth Ring Scanner, is a wearable barcode scan solution for both 1D and 2D barcode symbologies. The RS5100 is also compatible with a wide range of mobile computers communicating over Bluetooth.

The RS5100 Product Reference Guide provides additional information that is not covered by the Quick Start Guide and is helpful for application developers and customers alike.

This Product Reference Guide provides information on operating the RS5100 for the first time, using the RS5100, resetting and capturing data.

The guide also covers issues such as charging and testing the RS5100 battery, troubleshooting, maintenance, firmware update and configuration of the RS5100. Sample barcodes are provided for configuring and testing the RS5100.

Notational Conventions

The following conventions are used in this document:

- **Bold** text is used to highlight the following:
 - Dialog box, window and screen names
 - Drop-down list and list box names
 - Check box and radio button names
 - Icons on a screen
 - Key names on a keypad
 - Button names on a screen.
- Bullets (•) indicate:
 - Action items
 - Lists of alternatives
 - Lists of required steps that are not necessarily sequential.
- Sequential lists (e.g., those that describe step-by-step procedures) appear as numbered lists.

Service Information

If you have a problem with your equipment, contact Customer Support for your region. Contact information is available at: zebra.com/support.

When contacting support, please have the following information available:

- Serial number of the unit (found on manufacturing label)
- Model number or product name (found on manufacturing label)
- Software type and version number

The following information should be available when reporting a problem:

- Customer name
- Application used
- Configuration
- RS5100 or Cradle version number
- Go to [Retrieving the RS5100 Log File on page 116](#) to retrieve and E-mail the RS5100 log to the support representative
- Occurrence (always, once out of 10 attempts, etc...)
- Suggested steps to reproduce the problem

Customer Support responds to calls by email or telephone within the time limits set forth in support agreements.

If the problem cannot be solved by Customer Support, you may need to return your equipment for servicing and will be given specific directions. We are not responsible for any damages incurred during shipment if the approved shipping container is not used. Shipping the units improperly can possibly void the warranty.

If the device was purchased from a business partner, contact that business partner for support.

Table of Contents

Copyright	2
Terms of Use	2
Revision History	3
About This Guide	
Introduction	4
Notational Conventions	4
Service Information	5
Getting Started	
Introduction	10
Unpacking	10
Configuration Features	11
Status Indications	12
RS5100 Activity Modes	14
Configurations	14
Bluetooth Connection	19
Scanning	19
Resetting the RS5100	21
123Scan and Software Tools	
Introduction	23
123Scan	23
Bluetooth Communications	
Introduction	26
Bluetooth Communications Parameter Defaults	26
Bluetooth Status Indications	28
Bluetooth Connection Modes	28
Keyboard Emulation	29
Serial Port Profile	48
General Bluetooth Options	61
BLE Beacons	78

Accessories

Accessories 82
 Charging 85
 2-Bay Charger 88
 4-Slot RS5100 Charge Only Cradle 92
 20-Slot RS5100 Charge Only Cradle 94
 40-Slot Battery Charger 96
 Lanyard Mount 97
 Back of Hand Mount 99
 Enterprise Hand Mount 104
 Bluetooth Adapter 113

RS5100 Configuration and Update

Introduction 115
 Configuring the RS5100 115
 Real Time Logger 116
 RS5100 Firmware Update 117

Miscellaneous Imager Options

Introduction 119
 Scanning Sequence Examples 120
 Errors While Scanning 120
 User Preferences/Miscellaneous Options Parameter Defaults 120
 User Preferences 122
 Miscellaneous Scanner Parameters 142

Symbologies

Introduction 151
 Scanning Sequence Examples 151
 Errors While Scanning 151
 Symbology Parameter Defaults 152
 Enable/Disable All Code Types 158
 UPC/EAN 159
 Code 128 178
 Code 39 187
 Code 93 197
 Code 11 199
 Interleaved 2 of 5 (ITF) 203
 Discrete 2 of 5 (DTF) 210
 Codabar (NW - 7) 213
 MSI 217
 Chinese 2 of 5 222
 Matrix 2 of 5 223
 Korean 3 of 5 226
 Inverse 1D 227
 GS1 DataBar 228
 Composite 231
 2D Symbologies 235

Table of Contents

Postal Codes	247
Symbology-Specific Security Levels	255
Report Version	259
Macro PDF Features	260
Digimarc Barcode	
Introduction	261
Digimarc Symbology	261
Digimarc Digital Watermarks	262
Data Formatting: ADF, MDF, Preferred Symbol	
Introduction	263
Advanced Data Formatting (ADF)	263
Multicode Data Formatting (Hand-held Mode Only)	263
Preferred Symbol	264
OCR Programming	
Introduction	265
OCR Programming Parameters	267
Maintenance and Troubleshooting	
Introduction	300
Maintenance	300
Battery Safety Guidelines	300
Long Term Storage	301
Cleaning Instructions	301
Comfort Pad Replacement	304
Trigger Assembly Replacement	305
Finger Strap Replacement	306
Troubleshooting	308
Specifications	
RS5100 Technical Specifications	310
Charger Technical Specifications	313
Bluetooth Adapter Technical Specifications	316
Decode Distances	317
Standard Default Parameters	
Standard Default Parameters Table	318
Programming Reference	
Symbol Code Identifiers	327
AIM Code Identifiers	328

Alphanumeric and Numeric Barcodes

Numeric Barcodes 333
 Cancel 334

Sample Barcodes

Code 39 352
 UPC/EAN 352
 Code 128 353
 Interleaved 2 of 5 353
 GS1 DataBar-14 353
 PDF417 354
 Data Matrix 354
 Maxicode 354
 QR Code 355
 US Postnet 355
 UK Postal 355

Country Codes

Introduction 356
 Country Keyboard Types (Country Codes) 357

Country Code Pages

Introduction 372
 Country Code Page Defaults 372
 Country Code Page Barcodes 376

CKJ Decode Control

Introduction 385
 CJK Control Parameters 386
 Unicode/CJK Decode Setup with Windows Host 391

ASCII Character Sets

RSM Attributes

Attributes for Querying Scanner Information 404

BLE Beacons

BLE Beacons 405
 Beacons and Battery Use 407

Getting Started

Introduction

This chapter describes the features of the RS5100 Ring Scanner and explains how to install and charge the battery, capture data and reset the RS5100.

Unpacking

Carefully remove all protective material from around the equipment and save the shipping container for later storage and shipping.

After opening the shipping box, inspect the contents. You should have received the following:

- RS5100
- Battery
- Regulatory Guide
- Optional Trigger Mount Screw in a separate bag.

Inspect the equipment for damage. If you are missing any equipment or if you find any damaged equipment, contact Support immediately. See [Service Information on page 5](#) for contact information.

Configuration Features

Figure 1 RS5100 Single Trigger Configuration Features

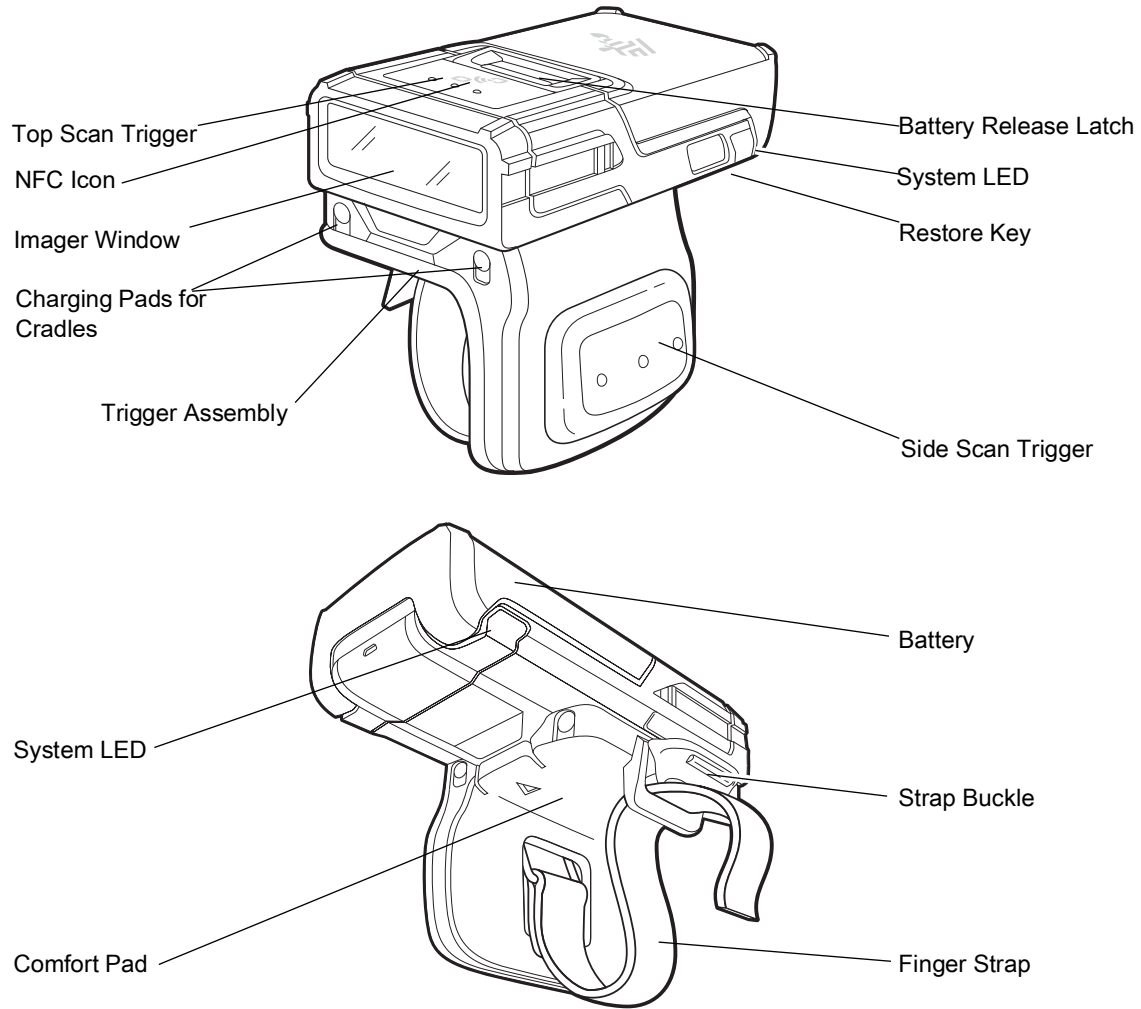
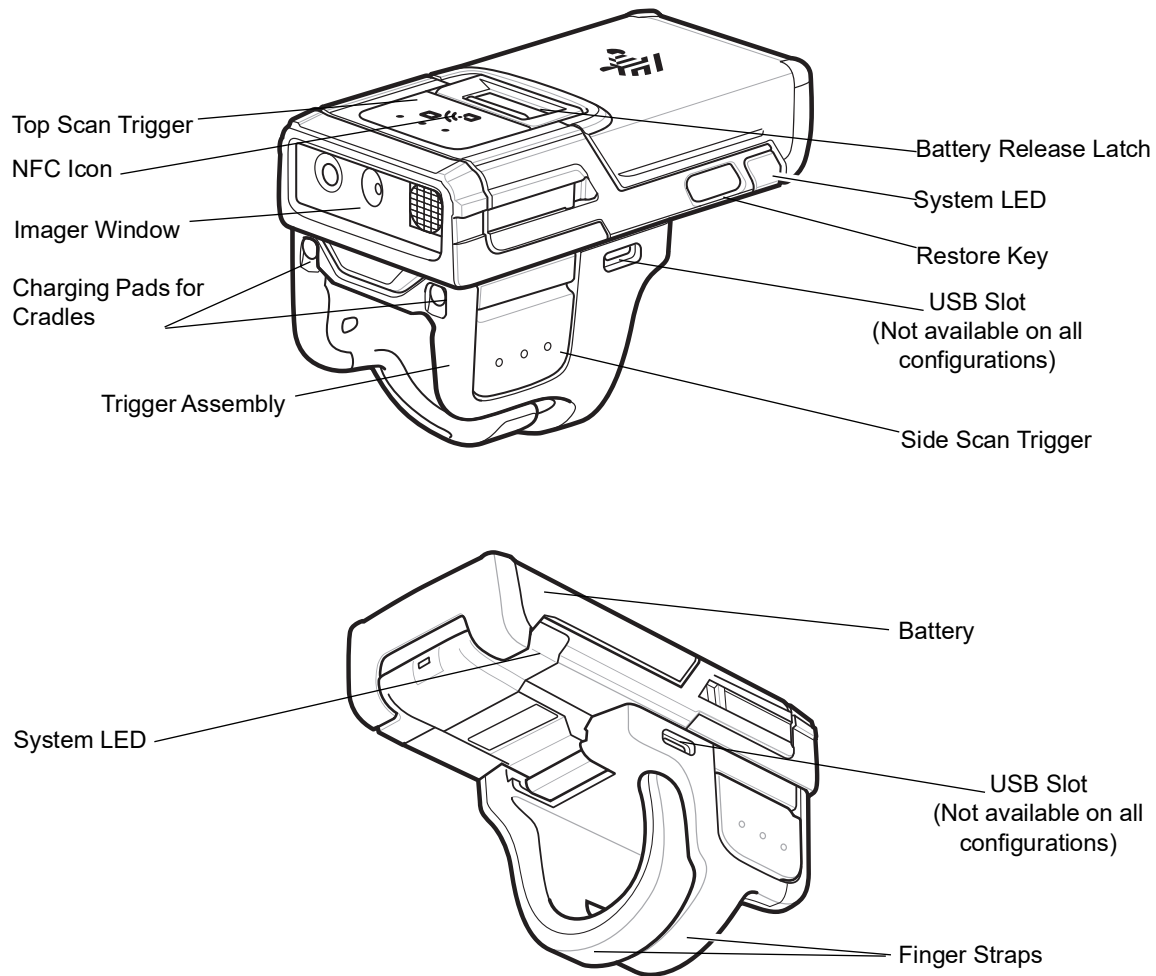

Figure 2 RS5100 Double Trigger Configuration Features



Status Indications

The RS5100 has System notification LEDs on the back of the device to display system and decode status and a System LED on the top of the device to display Bluetooth and battery status. The RS5100 is also equipped with a beeper that issues different beep sequences and patterns to indicate status. The System LEDs provide identical indications for ambidextrous usage.

[Table 1](#) defines the System LED and beep sequence indications that occur to indicate status.

Table 1 System LED Indications

LED Type	LED Indication	Beep Indication	Description
Standard Use			
System	Green	Low/Medium/High	Device is powered on.
Scanning Indications			
System	Green single flash	High	A barcode has been decoded

Table 1 System LED Indications (Continued)

LED Type	LED Indication	Beep Indication	Description
System	Red	4x Low	Transmission error.
System	Red	5x Low	Conversion or format error.
System	Red	Low/High/Low/High	Out of batch memory storage. Unable to store a new barcode.
Radio Indications			
System	Red/Green blinking	6x Short High	Device in paging state.
System	Blue double blink	High/low	Bluetooth communication is disconnected.
System	Blue slow blinking	None	Attempting to reconnect over Bluetooth.
System	None	Low/high	Bluetooth connection established.
System	None	Long low/ long high	Bluetooth connection attempt failed.
System	Blue during beep sequence	Long low/ long high/ Long low/ long high	Bluetooth connection attempt is rejected.
System	Blue slow blinking	5x High	Attempting to reconnect over Bluetooth (disabled by default).
System	Blue blinking	3x Short high	Bluetooth disconnect indication (disabled by default).
Battery Indications			
System	Red	4x Short high	Low battery indicator.
System	Red blinking	N/A	Over temperature or bad battery.
System (hold trigger for three seconds to activate) NOTE: The LED lights up for 3 seconds on the first scan after rebooting to show battery charge level indication.	Green	N/A	Battery charge level: high
	Green/Red alternating	N/A	Battery charge level: high, bad battery
	Amber	N/A	Battery charge level: medium
	Amber/Red alternating	N/A	Battery charge level: medium, bad battery
	Red	N/A	Battery charge level: low
	Red blinking	N/A	Battery charge level: low, bad battery
Parameter Programming			
System	Red	Long low/long high beeps	Input error, incorrect barcode or Cancel scanned, wrong entry, incorrect barcode programming sequence, remain in program mode.
System	Green	High/low beeps	Keyboard parameter selected. Enter value using barcode keypad.

Table 1 System LED Indications (Continued)

LED Type	LED Indication	Beep Indication	Description
System	Green	High/low/high/low beeps	Successful program exit with change in the parameter setting.
Maintenance Indications			
System	Green slow blinking		Scanner connected to 123Scan2.
System	Red fast blinking		File being transferred to the scanner (new configuration parameters or firmware) via 123Scan2.
System	Red slow blinking		Firmware installation.
System	Green		Programing completed successfully (parameters change or firmware updated) via 123Scan2.

RS5100 Activity Modes

The RS5100 is capable of three modes of activity:

- **Run Mode** – The RS5100 is scanning or transferring data using Bluetooth.
- **Low Power Mode** – The RS5100 enters Standby mode (Low Power Mode) when it is idle for more than one second. The RS5100 wakes-up and returns to busy (run) mode upon at least one of the following events:
 - Scan trigger
 - Bluetooth activity
 - NFC field detected
 - Press of the Restore key
 - Insert into charging slot
- **OFF Mode** – The RS5100 is not connected to a power source.

Configurations

The RS5100 can be worn with a Single Trigger Assembly or Double Trigger Assembly.



NOTE: After installing a different type of trigger, reboot the RS5100 to recognize the new trigger.

Single Trigger Assembly - Change Trigger Position

The RS5100 is worn on the index finger, and triggered with the thumb. The Trigger Assembly of the RS5100 is removable to provide left-hand or right-hand use.

To change the position of the trigger:

1. Determine whether the RS5100 is used on the right or left hand and rotate the trigger assembly accordingly, so that the Scan Trigger is positioned next to the thumb when the RS5100 is placed on the index finger.
2. Push the Trigger Assembly latch in, while lifting the Trigger Assembly away from the RS5100. Find the side with the arrow on the comfort pad, noting where the yellow latch is.

Figure 3 Push Trigger Assembly Latch In and Lift

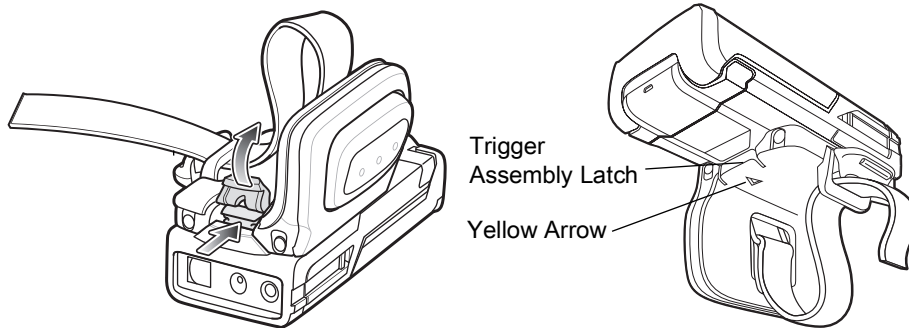

3. Lift the Trigger Assembly off of the RS5100.

Figure 4 Lift Trigger Assembly Off RS5100

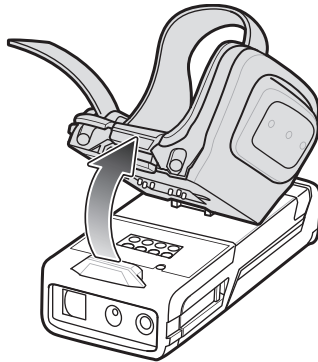

4. Rotate the Trigger Assembly so the Scan Trigger is positioned next to the thumb when the RS5100 is placed on the index finger.
5. Align one end of the Trigger Assembly on the RS5100 and push the other end down until it snaps into place.

Figure 5 Align Trigger Assembly and Snap Into Place

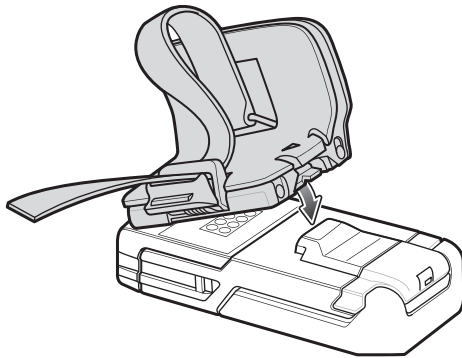

NOTE: An optional Trigger Mount screw is included in the packaging and can be used with a Phillips screwdriver to secure the Trigger Mount when it does not need to be removed or rotated. On the single trigger, the hole for the Trigger Mount screw is under the comfort pad, while on the double trigger the hole is visible from the outside.

Figure 6 Location of Trigger Mount Screw

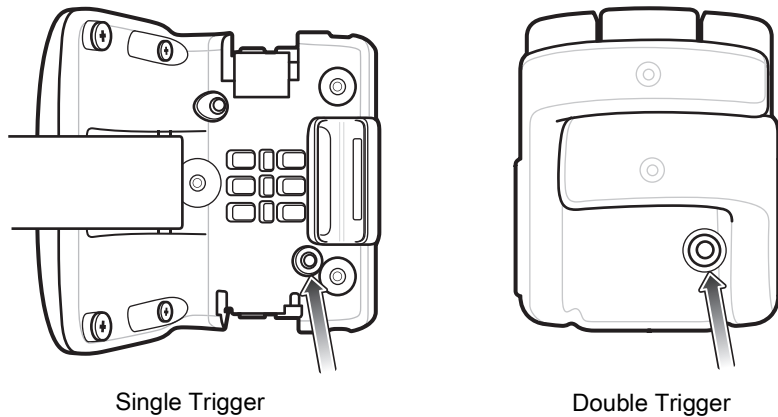

Double Trigger Assembly

The double trigger assembly comes in the following 3 configurations:

- Standard
- USB-C
- Vibrator

The USB-C port on the assembly allows the RS5100 to be charged via a USB cable and also allows for programming using 123Scan.

Charge the Battery

Before using the RS5100, charge the battery. To charge the RS5100 battery, go to [Accessories](#).

Install the Battery

1. Align the battery on top of the RS5100 and insert into the battery compartment.

Figure 7 Install the Battery

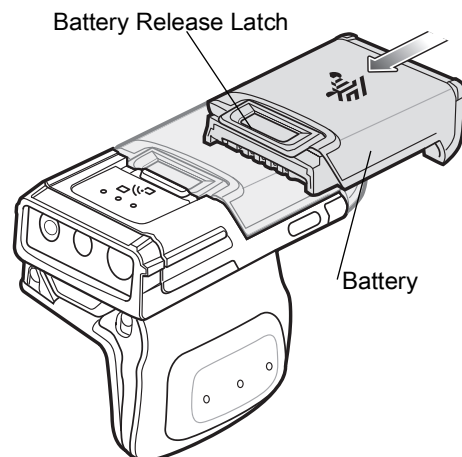

2. Slide the battery all the way into the locking slot of the RS5100.
3. Firmly press the battery into the RS5100 until a click is heard ensuring the battery release latch is fully engaged with the RS5100.



NOTE: Brand new batteries from the factory are shipped in Ship Mode for protection, and need to be plugged into a charger (cradle or battery toaster) to activate the battery.

Remove the Battery

1. Push the battery release latch down until the latch pops up.

Figure 8 Release Battery

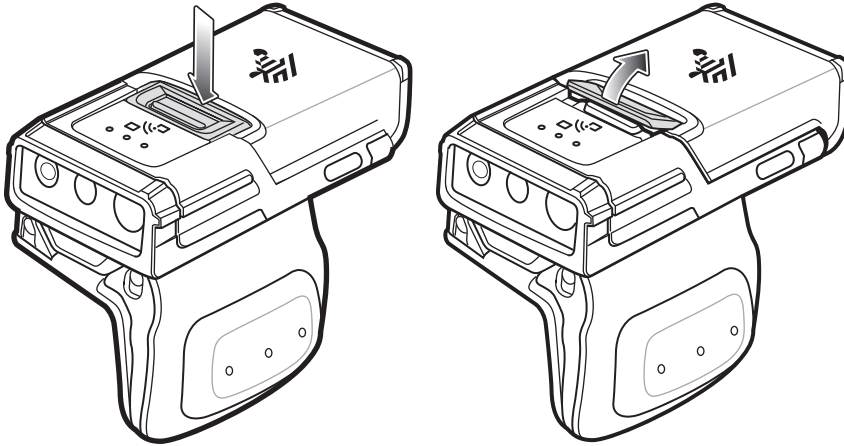

2. Slide the battery out of the battery compartment.

Figure 9 Remove the Battery

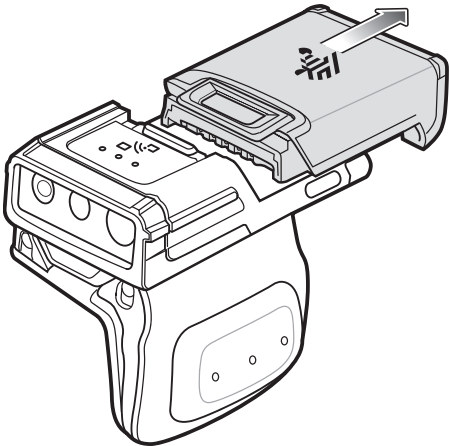

Mounting the RS5100

1. Slide the RS5100 onto the index finger with the Scan Trigger next to the thumb.

Figure 10 Slide RS5100 onto Index Finger

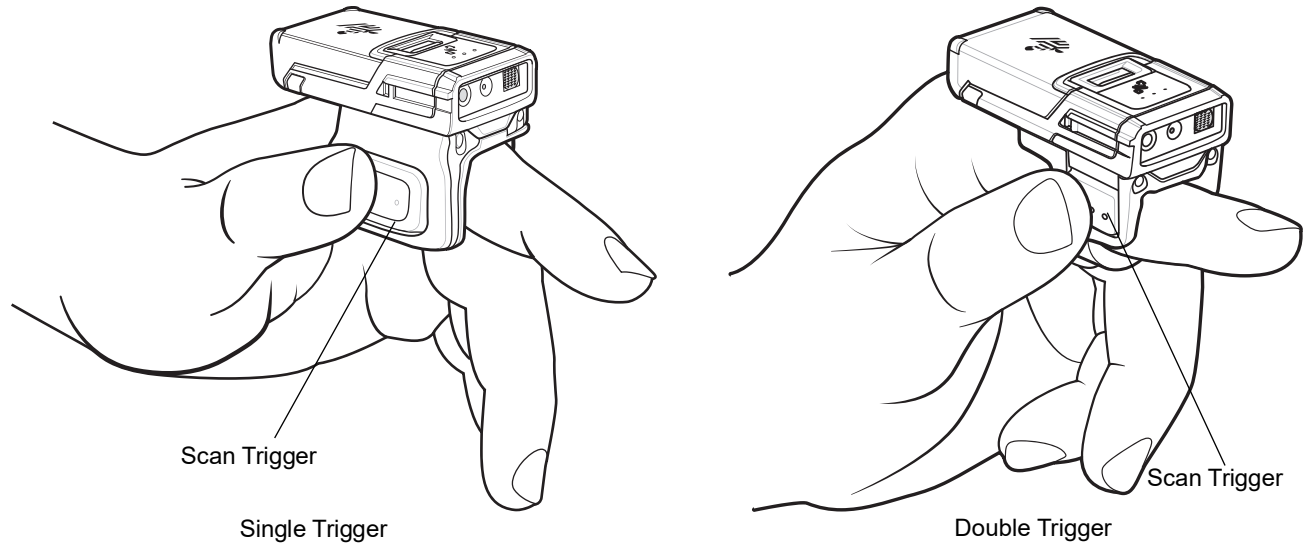

2. To tighten the Finger Strap on the Single Trigger, pull the end of the strap through the Strap Buckle. To loosen the Finger Strap, lift the Strap Buckle away from the Finger Strap while pulling the strap through the Strap Buckle. Release the Strap Buckle to hold the Finger Strap in place.

Figure 11 Adjust Finger Strap

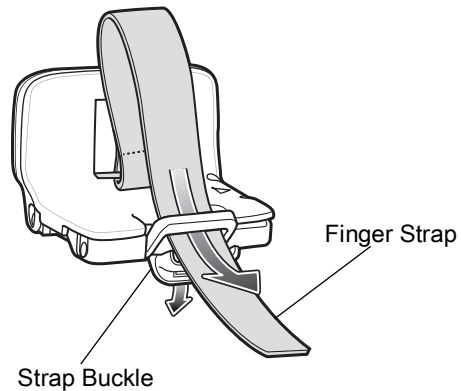

Powering On

To power on the device:

1. Install the battery (if not already installed).



NOTE: Brand new batteries from the factory are shipped in Ship Mode for protection, and need to be plugged into a charger (cradle or battery toaster) to activate the battery.

2. Press one of the following:
 - side scan trigger on the single trigger
 - left side scan trigger on the double trigger
 - scan trigger on the lanyard

- scan trigger on the back of hand mount.

Bluetooth Connection

The RS5100 sends decoded barcode data to Zebra mobile computers and other devices using Bluetooth. Before using, connect the RS5100 to a device using Bluetooth. See [Bluetooth Communications](#) for configuration.

Connecting to a host device consists of two distinct processes.

1. **Pairing:** The scanner pairs with the device. Pairing information is stored in the scanner's memory, and the two devices are associated with one another.
2. **Connecting:** Once paired, the scanner connects to the device. Connection allows the devices to communicate, sending data back and forth.

A scanner may disconnect from the host device for a variety of reasons. A disconnected scanner is still paired with the device. You can manually scan/tap to reconnect the scanner to the paired device.

Scanning

The RS5100 uses digital camera technology to take an image of a barcode and software decoding algorithms are executed to extract the barcode data from the image.

RS5100 Scanning with SE4710

To scan a barcode:

1. Launch a scanning application.
2. Press the Scan Trigger and aim the device at a barcode.
3. Adjust the position of the device so that the orange aiming dot appears at the center of the barcode.

Ensure the barcode is within the area formed by the aiming pattern. The aiming dot is used for increased visibility in bright lighting conditions.

The Status LED illuminates red. Upon successful decode, the Status LED changes from red to green and an audible beep sounds.



NOTE: When the device is in Picklist Mode, the imager does not decode the barcode until the crosshair or aiming dot touches the barcode.

4. Release the Scan Trigger.
The barcode data displays on the screen.

RS5100 Scanning with SE4770

To scan a barcode:

1. Launch a scanning application.
2. Press the Scan Trigger and aim the device at the barcode.
3. Adjust the position of the device so that the red laser cross-hair appears at the center of the barcode.
4. The status LED illuminates red. Upon successful decode, the status LED changes from red to green and an audible beep sounds.



NOTE: In some configurations proper decoding of a barcode is indicated by the software application running on the mobile computer.

Aiming the RS5100

The aiming pattern of the RS5100 is a cross hair laser beam with bright center dot (see [Figure 12](#)). The virtual rectangle made by the cross hair reflects the field of view of the RS5100. The aiming pattern is used to position the barcode within the field of view.

Figure 12 Cross Hair Laser Beam

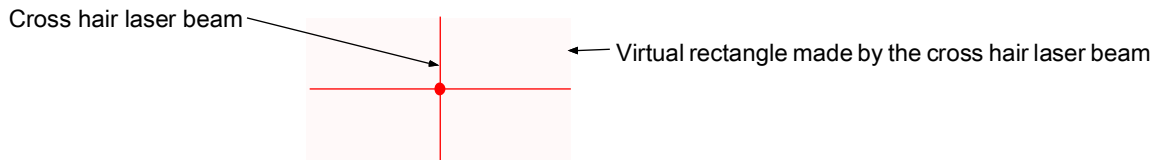

Enter the symbol in any orientation within the virtual rectangle made by the cross hair laser beam, making use of its omnidirectional reading capability within the entire field of view.

Figure 13 Barcode Scan Orientation

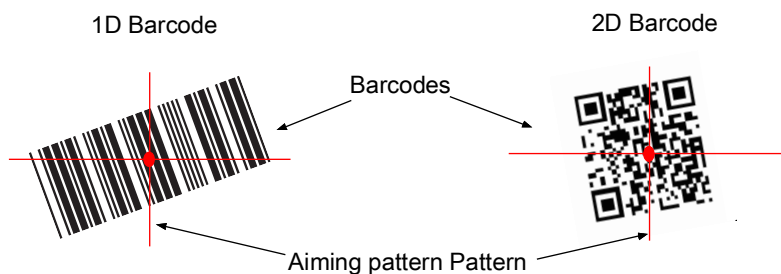

The RS5100 can also read a barcode presented within the aiming pattern but not centered (see the top barcodes on [Figure 14](#)). The barcodes marked with X in [Figure 14](#), however, show barcode aiming that may result in no decode.

When using the application on your mobile computer in “Pick List” mode, the Bright Center Dot can be positioned anywhere on the barcode (see [Figure 12](#)). The top examples in [Figure 14](#) show acceptable aiming options, while the bottom examples can not be decoded.

Figure 14 Acceptable Aiming Options

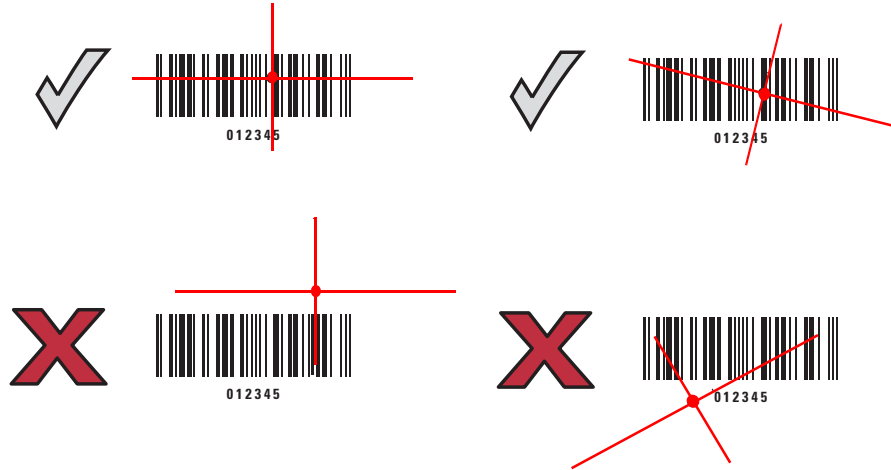

The aiming pattern is smaller when the RS5100 is closer to the barcode and larger when it is farther from the barcode. Scan barcodes with smaller bars or elements (mil size) closer to the RS5100 and those with larger bars or elements (mil size) farther from the RS5100.

1. Position the RS5100 between two and eleven inches from the barcode (depending on the barcode density).



NOTE: When a barcode is under transparent plastic or on a mobile computer screen, it is recommended to use a tilt (pitch) or skew scan angle to minimize reflection.

2. Aim the cross hair laser beam to cover the barcode. The RS5100 takes a digital picture (image) of the barcode and stores it in memory for decoding.

The Scan LED flashes green and a high beep sounds indicating that the barcode was properly decoded.

Resetting the RS5100

If the RS5100 stops responding to input, reset it. There are three reset functions, warm boot, cold boot and clean boot. Perform a warm boot first. If the RS5100 still does not respond, perform a cold boot. Perform clean boot to restore the RS5100 to its factory default configuration.

Warm Boot

To perform warm boot, press and hold the Restore Key for more than three seconds and then release. The RS5100 resets when the key is released.



NOTE: A warm boot should be performed to reset the RS5100 after scanning the configuration barcodes.

Cold Boot

Cold boot restores the RS5100 operation by performing a power cycle of the device. To perform cold boot, remove and re-insert the battery into the RS5100.

Clean Boot

Clean Boot restores the RS5100 to its factory default configuration.

To perform clean boot:

1. Make sure the battery is inserted and the scanner is turned on.
2. Press and hold the Restore Key until the System LED turns on white.
3. Release the Restore Key and immediately press and hold the Restore Key.
4. Continue to hold the Restore Key until two beeps indicating a Clean Boot are heard and the scanner boot beep sequence is heard. The RS5100 is now in its factory default configuration.

123Scan and Software Tools

Introduction

This chapter briefly describes the Zebra software tools available for customizing scanner operation.

123Scan

123Scan is a software tool that simplifies scanner setup and more.

Intuitive enough for first time users, the 123Scan wizard guides users through a streamlined setup process. Settings are saved in a configuration file that can be printed as a single programming barcode for scanning, emailed to a smart phone for scanning from its screen, or downloaded to the scanner using a USB cable.

Through 123Scan a user can:

- Configure a scanner using a wizard.
 - Program the following scanner settings.
 - Speaker tone / volume settings.
 - Enable / disable symbologies.
 - Communication settings.
 - Modify data before transmission to a host using:
 - Advanced Data Formatting (ADF) - Scan one barcode per trigger pull.
 - Multicode Data Formatting (MDF) - Scan many barcodes in one trigger pull (select scanners).
 - Preferred Symbol - Single out one barcode on label of many (select scanners).
- Load parameter settings to a scanner via the following.
 - Barcode scanning.
 - Scan a paper barcode.
 - Scan a barcode from a PC screen.
 - Scan a barcode from a smart phone screen.
 - Download over a USB cable.
 - Load settings to one scanner.
- Validate scanner setup.
 - Review settings using the Parameter Report.
 - Clone settings from an already deployed scanner from the **Start** screen.

- Upgrade scanner firmware.
 - Load settings to one scanner.
- View statistics such as:
 - Asset tracking information.
 - Time and usage information.
 - Barcodes scanned by symbology.
 - Battery diagnostics (select scanners).
- Generate the following reports.
 - Barcode Report - Programming barcode, included parameter settings, and supported scanner models.
 - Parameter Report - Parameters programmed within a configuration file.
 - Inventory Report - Scanner asset tracking information.
 - Statistics Report - All statistics retrieved from the scanner.



NOTE: Data view is not supported.

For more information go to: www.zebra.com/123Scan.

Communication with 123Scan

Use a USB cable to connect the scanner to a Windows host computer running 123Scan.

123Scan Requirements

- Host computer running Windows XP, 7, 8, and 10
- Scanner
- USB cable.

123Scan Information

For more information on 123Scan, go to: www.zebra.com/123Scan.

For a 1 minute tour of 123Scan, go to: www.zebra.com/ScannerHowToVideos.

To see a list of all of our software tools, go to: www.zebra.com/scannersoftware.

Scanner SDK, Other Software Tools, and Videos

Tackle all your scanner programming needs with our diversified set of software tools. Whether you need to simply stage a device, or develop a fully featured application with data capture as well as asset management, these tools help you every step of the way.

To download any of the following free tools, go to: www.zebra.com/scannersoftware.

- 123Scan configuration utility

- SDKs
 - Scanner SDK for Windows
 - Scanner SDK for Android
 - Scanner SDK for iOS
- Drivers
 - OPOS driver (supported over Bluetooth only)
 - USB CDC driver



NOTE: Video and SMS are not supported.

- Mobile Apps
 - Scan-To-Connect Utility
 - Android
 - iOS
 - Windows
 - Zebra AppGallery
- How-To-Videos

Bluetooth Communications

Introduction

This chapter provides information about the modes of operation and features available for wireless communication between the RS5100 and hosts. The chapter also includes the parameters necessary to configure the RS5100.

The RS5100 ships with the settings shown in the [Bluetooth Communication Defaults on page 27](#) (also see [Standard Default Parameters](#) for all host device and miscellaneous RS5100 defaults). If the default values suit user requirements, programming is not necessary.

To set feature values, scan a single barcode or a short barcode sequence. The settings are stored in non-volatile memory and are preserved even when the RS5100 is powered down.

To return all features to default values, scan a default barcode in [Default Parameters on page 122](#). Throughout the programming barcode menus, default values are indicated with asterisks (*).

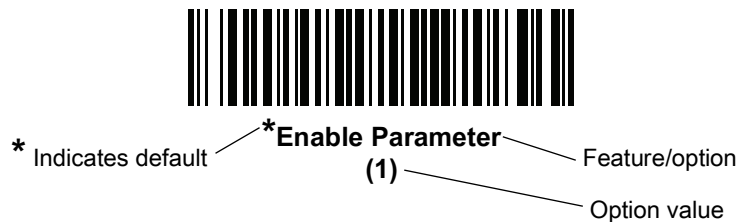

Scanning Sequence Examples

In most cases, scan one barcode to set a specific parameter value.

Errors While Scanning

Unless otherwise specified, to correct an error during a scanning sequence, just re-scan the correct parameter.

Bluetooth Communications Parameter Defaults

[Table 2](#) lists the defaults for Bluetooth radio communication parameters. If you wish to change any option, scan the appropriate barcode(s)



NOTE: See [Standard Default Parameters](#) for all user preferences, hosts, symbologies, and miscellaneous default parameters.

In this guide, the parameter numbers listed are the same as the attribute numbers for these parameters.

See [Country Codes](#) for Country Keyboard Types (Country Codes).

Table 2 Bluetooth Communication Defaults

Parameter	Parameter Number	Default	Page Number
Bluetooth Communications Host Types		SSI Bluetooth Classic	
Default BT Friendly Name	1701	Disable	61
Discoverable Mode	610	General	62
Wi-Fi Friendly Mode		Disable	64
Wi-Fi Friendly Channel Exclusion		Use All Channels	65
Radio Output Power	1324	Class 2	66
Link Supervision Timeout	1698	2 Seconds	67
HID Features for Apple iOS	1114	Disable	33
HID Keyboard Keystroke Delay		No Delay (0 msec)	33
HID CAPS Lock Override		Disable	35
Ignore Unknown Characters		Enable	35
Emulate Keypad		Disable	36
Fast HID Keyboard	1361	Enable	37
Quick Keypad Emulation	1362	Enable	38
Keyboard FN1 Substitution		Disable	38
Function Key Mapping		Disable	39
Simulated Caps Lock		Disable	39
Convert Case		No Case Conversion	40
Beep on Reconnect Attempt	559	Disable	69
Reconnect Attempt Interval	558	30 sec	69
Auto-reconnect	604	Auto-reconnect Immediately	71
Beep on Insertion	288	Enable	124
Beep on <BEL>	150	Enable	56
Toggle Pairing	1322	Disable	71
Force Pairing Save	795	Enable	72

Table 2 Bluetooth Communication Defaults (Continued)

Parameter	Parameter Number	Default	Page Number
Auto Un-Pairing	1708	Disable	72
Batch Mode	544	Normal (Do Not Batch Data)	74
Unique Identifier		Disable	76
PIN Code (Set and Store)	552	12345	62
Variable Pin Code	608	Static (Default PIN code is 12345)	63
Bluetooth Security Levels	1393	Low	63
Battery Threshold	1367, 1368, 1369	N/A	76
Beacon Upon Disconnection	2403	Disable	78
Unpaired Beaconing	2404	Disable	78
Beaconing Beep	2405	Disable	79
Beacon Frequency	2406	100 msec	79
Beacon Battery Threshold	2407	30%	79
Beacon ID	2408, 2409	N/A	81

Bluetooth Status Indications

When the RS5100 is pairing or re-establishing a connection to a computer, it issues various beep sequences indicating successful or unsuccessful operations. Go to [Status Indications on page 12](#) for all beep sequences and LED displays including those which occur during pairing operations.

Bluetooth Connection Modes

The RS5100 can connect to a host computer using the following Bluetooth modes:

- Human Interface Device (HID)
- Simple Serial Interface (SSI)
- Serial Port Profile (SPP).



NOTE: Once the RS5100 is paired to a Zebra host device, the scanning software will disable the ability to read the configuration barcodes.

Keyboard Emulation

The Bluetooth Human Interface Device (HID) profile enables the RS5100 to emulate a Bluetooth keyboard input device and connect to a host computer. The RS5100 supports two versions of the Bluetooth HID profile.

HID Bluetooth Classic

Enables the RS5100 to communicate using Bluetooth HID profile to a host computer through Bluetooth Classic radio. The RS5100 is capable of operating in Peripheral (discoverable) or Central mode.

HID Bluetooth Low Energy (Discoverable)

Enables the RS5100 to communicate using Bluetooth HID profile to a host computer through Bluetooth Low Energy radio. The RS5100 operates in Peripheral (discoverable) mode when BT HID Low Energy is enabled.

Low Energy (LE) Bluetooth has a smaller RF footprint (bandwidth) than Classic Bluetooth. The smaller RF footprint of LE Bluetooth significantly improves Wi-Fi co-existence. Due to its smaller RF bandwidth, LE Bluetooth is up to seven times slower than Classic Bluetooth (0.27 Mbps versus 0.7-2.1 Mbps). Data intensive activities such as firmware updates, can take significantly longer.



NOTE: Not all host devices support Bluetooth Low Energy. Verify that your device supports Bluetooth Low Energy mode before attempting to connect to the RS5100.

HID Bluetooth Barcodes

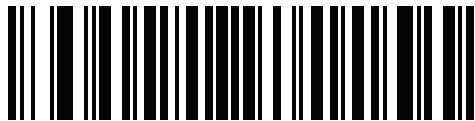

HID Bluetooth Classic

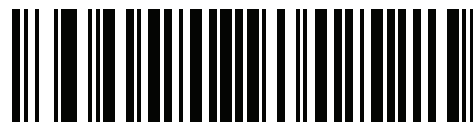

HID Bluetooth Low Energy

HID Setup

HID Bluetooth Connection to iOS/iPad/iPhone

1. Perform clean boot. Go to [Clean Boot on page 22](#).
2. Scan the appropriate HID Bluetooth Barcode.
3. Perform a Cold Boot by removing and re-installing the battery onto the RS5100. The RS5100 starts to operate and is discoverable as a keyboard.
4. Select **Settings > General > Bluetooth**.

5. Turn Bluetooth **ON**.
6. Select **Bluetooth Settings** and choose RS5100 from the list of discovered devices. The RS5100 displays as RS5100 - xxxxxx, where xxxxxx is the serial number.

HID Bluetooth Connection to Android

1. Perform clean boot. Go to [Clean Boot on page 22](#)
2. Scan the appropriate HID Bluetooth Barcode from the [HID Bluetooth Barcodes](#) table.
3. Perform a Cold Boot by removing and re-installing the battery onto the RS5100. The RS5100 starts to operate and is discoverable as a keyboard.
4. Select **Settings > Wireless & Networks > Bluetooth**
5. Turn Bluetooth **ON**.
6. Select **Bluetooth Settings** and choose RS5100 from the list of discovered devices. The RS5100 displays as RS5100 - xxxxxx, where xxxxxx is the serial number.



IMPORTANT: Some devices may require scanning a PIN to connect. If so, a PIN displays on the device. To enter the required PIN, scan the barcode, [Variable PIN Code on page 63](#) then re-attempt connection. When a beep sounds, indicating the RS5100 is waiting for PIN entry, scan the PIN using the [Alphanumeric and Numeric Barcodes on page 333](#). Incorrect scanned entries can be deleted by scanning [Cancel on page 334](#).

For more information, see [Variable PIN Code on page 63](#).

HID Bluetooth Connection to Windows 7 or 8



NOTE: For best user experience, it is recommend using Secure Simple Pairing (SSP). Windows 7 SP1 supports Bluetooth 2.1 and as such, supports SSP.

SSP reduces the number of steps to minimal or none when compared to legacy Bluetooth pairing.

If the host computer does not include an integrated Bluetooth module, use a USB Bluetooth dongle.

Use off-the-shelf dongle that supports Bluetooth v2.1 for effortless pairing in SSP.

To pair and connect the RS5100:

1. Perform clean boot. See [Clean Boot on page 22](#)
2. Scan the HID Bluetooth Classic barcode from page [29](#).
3. Perform a Cold Boot by removing and re-installing the battery onto the RS5100. The RS5100 starts to operate and is discoverable as a keyboard.
4. Right click on Bluetooth icon and select **Add a Device** (Windows 7) or **Add a Bluetooth Device** (Windows 8).

Figure 15 HID - Adding a Device - Windows

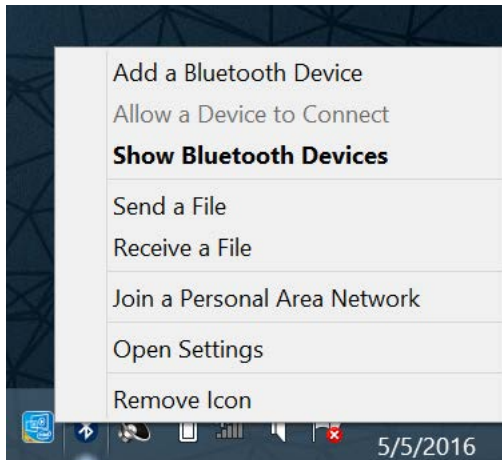

5. From the **Add a device** screen, select the RS5100 (shown as Bluetooth Keyboard) and click **Next**.

Figure 16 HID - Add Device Screen - Windows

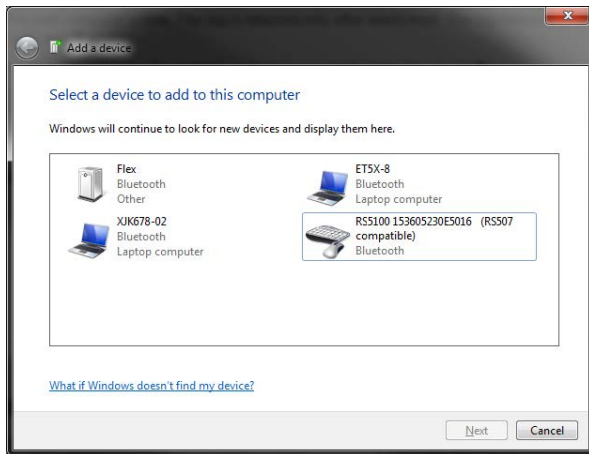

Windows 7

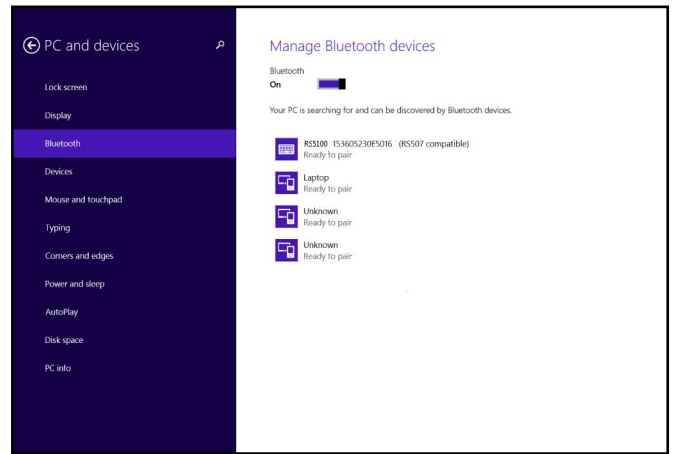

Windows 8

The computer connects to the RS5100 and the following screen displays.

Figure 17 HID - Device Successfully Added Screen - Windows

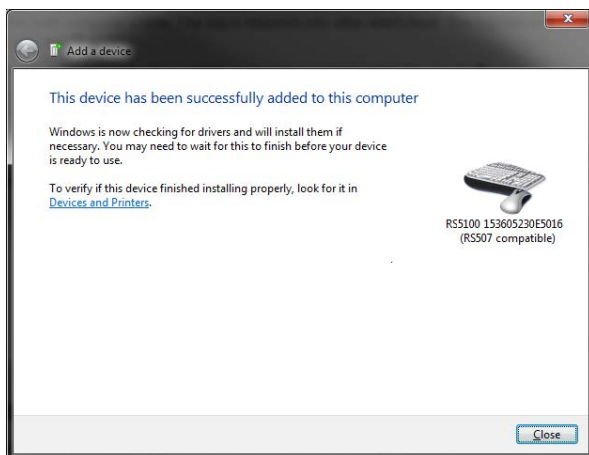

Windows 7

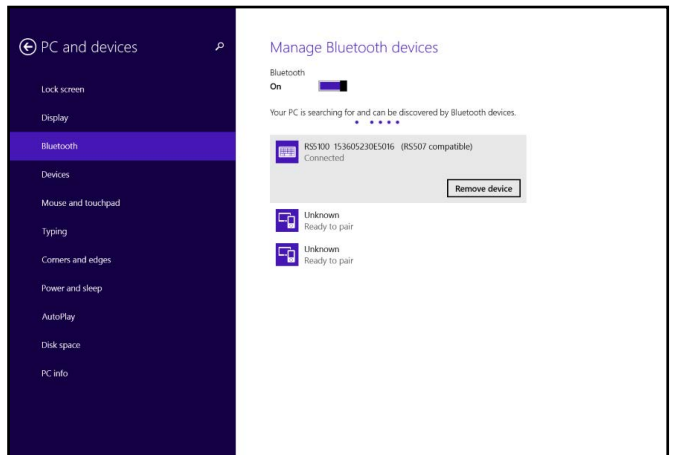

Windows 8

Demonstrating HID Connection

Following a successful connection, data can be scanned into any Windows, iOS or Android application field that accepts keyboard data; for example, in Windows, the Notepad application.

To scan a barcode:

1. Open the Notepad application.
2. Click in the text area.
3. Scan a barcode. The scanned barcode information displays on the Notepad window.

Figure 18 HID - Scanned Barcode Information On Notepad Window

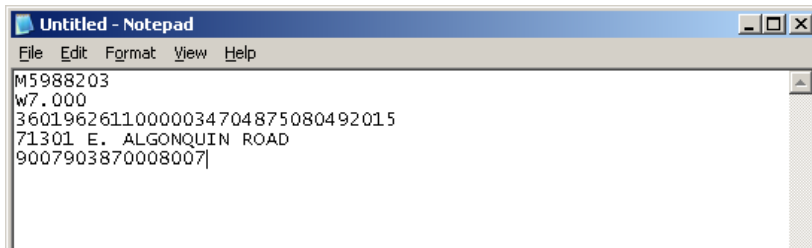

HID Options

The RS5100 supports virtual keyboard emulation for the Apple iOS, and keyboard emulation over the Bluetooth HID profile. In this mode the RS5100 can interact with Bluetooth enabled hosts supporting the HID profile as a Bluetooth keyboard. Scanned data is transmitted to the host as keystrokes.

HID Features for Apple iOS

Parameter # 1114

This option works with Apple iOS devices to enable the opening and closing of the iOS virtual keyboard by pressing the Restore key.



NOTE: When this feature is enabled, the RS5100 may be incompatible with non-Apple iOS devices.



***Disable
(0)**



**Enable
(1)**

HID Keyboard Keystroke Delay

This parameter sets the delay, in milliseconds, between emulated keystrokes. Scan a barcode below to increase the delay when the HID host requires a slower transmission of data.



***No Delay (0 msec)**



Medium Delay (20 msec)



Long Delay (40 msec)

HID CAPS Lock Override

When enabled, the case of the data is preserved regardless of the state of the caps lock key. This setting is always enabled for the “Japanese, Windows (ASCII)” keyboard type and can not be disabled.



***Do Not Override Caps Lock Key
(Disable)**



**Override Caps Lock Key
(Enable)**

HID Ignore Unknown Characters

This option applies only to the HID Keyboard Emulation device and IBM device. Unknown characters are characters the host does not recognize. When **Send Barcodes With Unknown Characters** is selected, all barcode data is sent except for unknown characters, and no error beeps sound. When **Do Not Send Barcodes With Unknown Characters** is selected, barcode data is sent up to the first unknown character, then the RS5100 issues an error beep.



***Send Barcodes With Unknown Characters
(Enable)**



**Do Not Send Barcodes With Unknown Characters
(Disable)**

Emulate Keypad

When enabled, all characters are sent as ASCII sequences over the numeric keypad. For example, ASCII A is sent as "ALT make" 0 6 5 "ALT Break."



***Enable Numeric Keypad Emulation**



Disable Numeric Keypad Emulation

Fast HID Keyboard

Parameter # 1361

This option transmits Bluetooth HID keyboard data at a faster rate.



Fast HID Disable

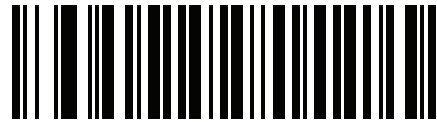

***Fast HID Enable**

Quick Keypad Emulation

Parameter # 1362



NOTE: This option applies only to a HID Keyboard Emulation Device which has **Emulate Keypad** enabled (see [Emulate Keypad on page 36](#)).

This parameter enables a quicker method of keypad emulation where ASCII sequences are only sent for ASCII characters not found on the keyboard.

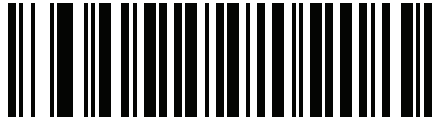

Quick Keypad Emulation Disable

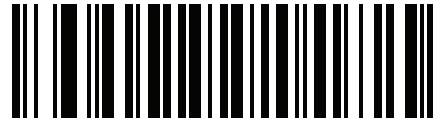

***Quick Keypad Emulation Enable**

HID Keyboard FN1 Substitution

When enabled, this parameter allows replacement of any FN1 character in an EAN128 barcode with a Key Category and value chosen by the user. See [FN1 Substitution Values on page 146](#) to set the Key Category and Key Value.



***Disable Keyboard FN1 Substitution**



Enable Keyboard FN1 Substitution

HID Function Key Mapping

ASCII values under 32 are normally sent as control-key sequences. When this parameter is enabled, the keys in bold are sent in place of the standard key mapping (see [ASCII Character Sets](#)).

Table entries that do not have a bold entry remain the same whether or not this parameter is enabled.



***Disable Function Key Mapping**



Enable Function Key Mapping

Simulated Caps Lock

When enabled, the RS5100 inverts upper and lower case characters on the RS5100 barcode as if the Caps Lock state is enabled on the keyboard. This inversion is done regardless of the current state of the keyboard Caps Lock state.



***Disable Simulated Caps Lock**



Enable Simulated Caps Lock

Convert Case

When enabled, the RS5100 converts all barcode data to the selected case.



***No Case Conversion**



Convert All to Upper Case



Convert All to LowerCase

Country Keyboard Type Change

While in HID mode, the RS5100 supports several keyboard layouts.

To change the North American Standard Keyboards layout to a different country code layout, scan the required barcode corresponding to the country keyboard type. See [Country Codes](#) for country keyboard types.

Simple Serial Interface (SSI)

Select this host type when connecting to a Zebra mobile device or PC/tablet/phone running a Zebra scanner SDK app.

SSI Bluetooth Classic (Non-discoverable)

This enables the scanner(s) to establish a connection with a Zebra mobile computer over a Bluetooth Classic radio. The scanner is NOT discoverable (Central mode).

To establish a connection (initial setup only), scan the **SSI BT Classic (Non-discoverable)** barcode, and then scan a pairing barcode with the host device's MAC address.



NOTE: Additional steps may be necessary depending on host's Bluetooth stack.

SSI Bluetooth Classic (Discoverable)

This enables communication with Scanner SDK for Android generated apps, and allows the host to establish a connection with the scanner over Bluetooth Classic radio. The scanner is discoverable (Peripheral mode).

To establish a connection (initial setup only), scan the **SSI Bluetooth Classic (Discoverable)** barcode. From the host, discover Bluetooth devices and select the scanner from the discovered device list.

SSI Bluetooth Low Energy

This enables communication with Scanner SDK for iOS generated apps, and allows the host to establish a connection with the scanner over Bluetooth Low Energy radio. The scanner is discoverable (Peripheral mode).

To establish a connection (initial setup only), scan the **SSI Bluetooth Low Energy** barcode. From the host application, select the scanner from the discovered device list.



SSI Bluetooth Classic (Non-discoverable)



SSI Bluetooth Classic (Discoverable)



SSI Bluetooth Low Energy

SSI Setup

SSI Bluetooth Connection using NFC

The RS5100 is NFC enabled and supports Bluetooth Tap-to-Pair.

To connect with a WT6000:

1. Check that NFC is enabled on the WT6000.
2. Align the NFC icon of the RS5100 with the NFC icon on the WT6000.

The Status LED blinks blue, indicating that the RS5100 is attempting to establish connection with the WT6000. When connection is established, the Status LED turns off and the RS5100 emits a single string of low/high beeps.

Figure 19 Touch NFC Antennas

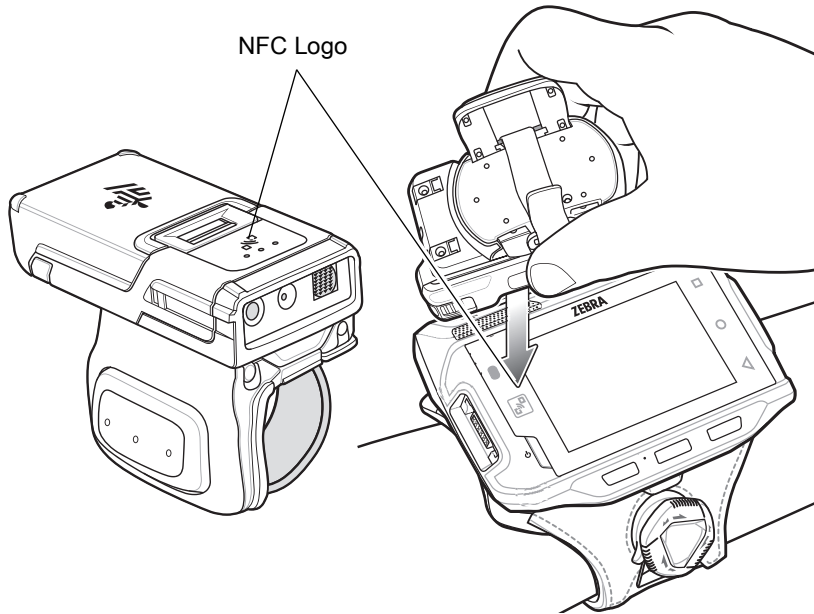

NOTE: Not all Zebra device support NFC readers and the Tap-to-Pair feature.

Pairing With a Mobile Device

To pair the RS5100 with a device, such as the WT6000 or TC52 using SSI:

1. On the device, open **Settings > Bluetooth Pairing Utility**. The Bluetooth Pairing Utility opens.

Figure 20 Bluetooth Pairing Utility



2. Using the RS5100, scan the barcode on the screen.

The Status LED blinks blue indicating that the RS5100 is attempting to establish a connection with the device. When a connection is established, the Status LED turns off and the RS5100 emits a single string of low/high beeps.

The device indicates a successful pairing attempt with a toast notification (audio and visual). When the Bluetooth connection is established, dialog box notifications appear on the device's screen.

3. On the device, touch  to return to the main screen.

Pairing with a Bluetooth Adapter

To pair the RS5100 with a host computer using a Bluetooth Adapter (BT-RS5X6-DNGL-01):

1. Using the RSS5100, scan the pairing code (1) on the adapter.

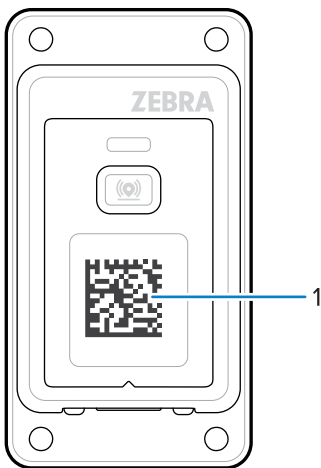

2. The Status LED blinks blue, indicating that the R5100 is attempting to establish a connection with the device. When a connection is established, the Status LED turns off and the RS5100 turns off and the RS5100 emits a single string of low/high beeps.

SSI Bluetooth Connection using STB3678 cradle

For information on STB3678 cradle configuration and usage refer to the DS36x8 user guide.

To pair the RS5100 with a STB3678 cradle:

1. Connect the STB3678 cradle to the host computer.
2. Using the RS5100, scan the pairing barcode on the STB3678 cradle.

The Status LED blinks blue indicating that the RS5100 is attempting to establish a connection with the STB3678. When the connection is established, the Status LED turns off and the RS5100 emits a single string of low/high beeps.



NOTE: Before pairing the RS5100 with a different device, perform clean boot. Go to [Clean Boot on page 22](#).

Point-to-Point Communication

In Point-to-Point communication mode, the cradle allows one digital scanner to connect to it at a time. In this mode, the digital scanner is paired to the cradle either by insertion into the cradle (if pairing on contacts is enabled), or by scanning the PAIR barcode. Communication can be locked, unlocked (default), or in a lock override state. In locked mode, locking intervals must be set by scanning a connection maintenance interval barcode.

Pairing Modes

When operating with the cradle, two modes of pairing are supported:

Locked Pairing Mode - When a cradle is paired (connected) to the digital scanner, any attempt to connect a different digital scanner, by either scanning the PAIR barcode on the cradle or by inserting it into the cradle with the pairing on contacts feature enabled, is rejected. The currently connected digital scanner(s) maintain connection. In this mode, you must set a Connection Maintenance Interval.

Unlocked Pairing Mode - Unlocking works in Point-to-Point mode only. Pair (connect) a new digital scanner to a cradle at any time by either scanning the PAIR barcode on the cradle or by inserting it into the cradle with the pairing on contacts feature enabled. This unpairs the previous digital scanner from the cradle.

Lock Override

Lock Override overrides a locked digital scanner base pairing and connects a new digital scanner.

Host Trigger Event Mode

Parameter #790

RS5100 is compatible with the STB3678 cradle and apps that utilize Zebra Scanner SDK, as well as Zebra host terminals apps that use EMDK. However, appropriate host trigger event mode has to be selected when partnering with those devices. RS5100 selects appropriate mode automatically, based on the pairing barcode, but it can be also manually set in case an appropriate pairing barcode is not used.

Use Host Trigger Event disabled mode for pairing with STB3678 cradle or Zebra Scanner SDK apps and utilities running on Windows, Android, or Apple iOS.

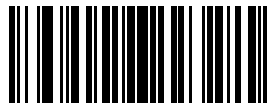

***Host Trigger Event Mode Enabled**

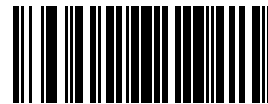

Host Trigger Event Mode Disabled

Serial Port Profile

Select this host type when connecting to a PC/tablet/phone using a Bluetooth serial connection.

SPP BT Classic (Non-discoverable)

This enables the scanner to establish an SPP connection with the host over Bluetooth Classic radio. The scanner is not discoverable (Central mode).

To establish a connection (initial setup only), scan the **SPP BT Classic (Non-discoverable)** barcode, and then scan a pairing barcode with the MAC address of the host device.

SPP BT Classic (Discoverable)

This enables the host to establish an SPP connection with the scanner over Bluetooth Classic radio. The scanner is discoverable (Peripheral mode).

To establish a connection (initial setup only), scan the **SPP BT Classic (Discoverable)** barcode. From the host, discover Bluetooth devices and select the scanner from the discovered device list.

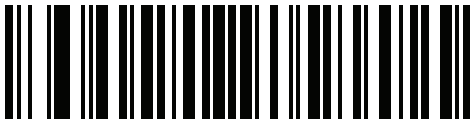

SPP Bluetooth Classic (Non-discoverable)

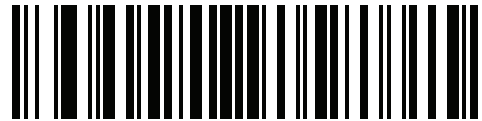

SPP Bluetooth Classic (Discoverable)



NOTE: Since the SPP connection does not support automatic acknowledgment when the data is received by the computer application, a BELL indication is used.

The BELL indication allows the computer application to send single binary character 0x07 to the RS5100 (as defined in ASCII table). Upon receiving the BELL character, the RS5100 beeps. To configure the beep, go to [Bell Indication Control on page 56](#).

SPP Setup

SPP Bluetooth Connection to Windows 7 or 8 as Central

1. Perform clean boot. Go to [Clean Boot on page 22](#).
2. Scan the SPP Bluetooth Classic (Non-Discoverable) barcode.
3. Perform a Cold Boot by removing and re-installing the battery onto the RS5100. The RS5100 starts to operate and is discoverable as a Bluetooth serial device.
4. Right click on the Bluetooth icon and select **Open Setting** to add a COM port

Figure 21 SPP - Open Setting Screen - Windows

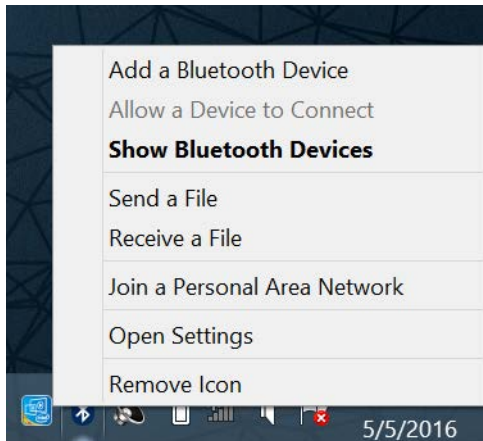

5. Select the **COM Ports** tab and click **Add**.

Figure 22 SPP - Bluetooth Settings - Com Ports Tab

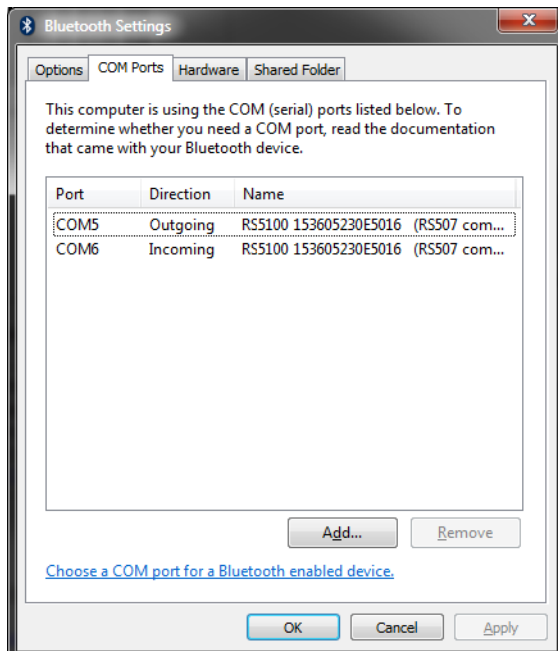

6. Select the **Incoming** radio button and click **OK**.

Figure 23 SPP - Bluetooth Settings - Add Com Port Screen

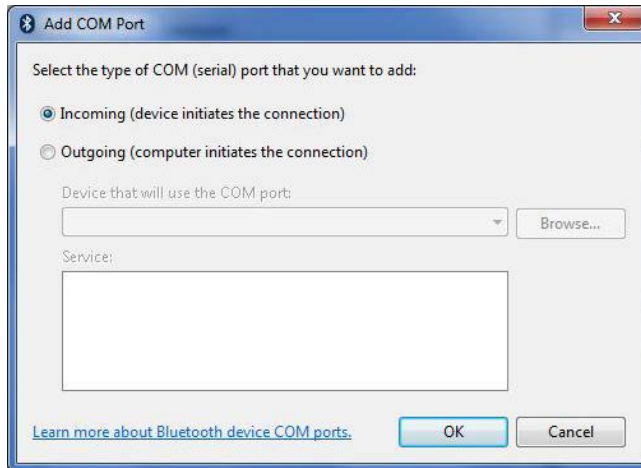

7. Click the **Hardware** tab.
8. Click the **Properties** button.
9. Click the **Advanced** tab to retrieve the Bluetooth radio BD address in the **Address** field.
10. Click **OK**.

Figure 24 SPP - Bluetooth Settings - Bluetooth Radio BD Address

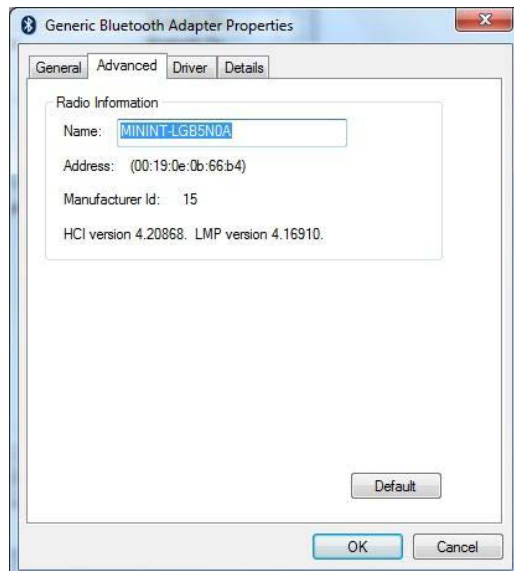

11. Run the PC Tool application.

Figure 25 SPP - PC Tool application

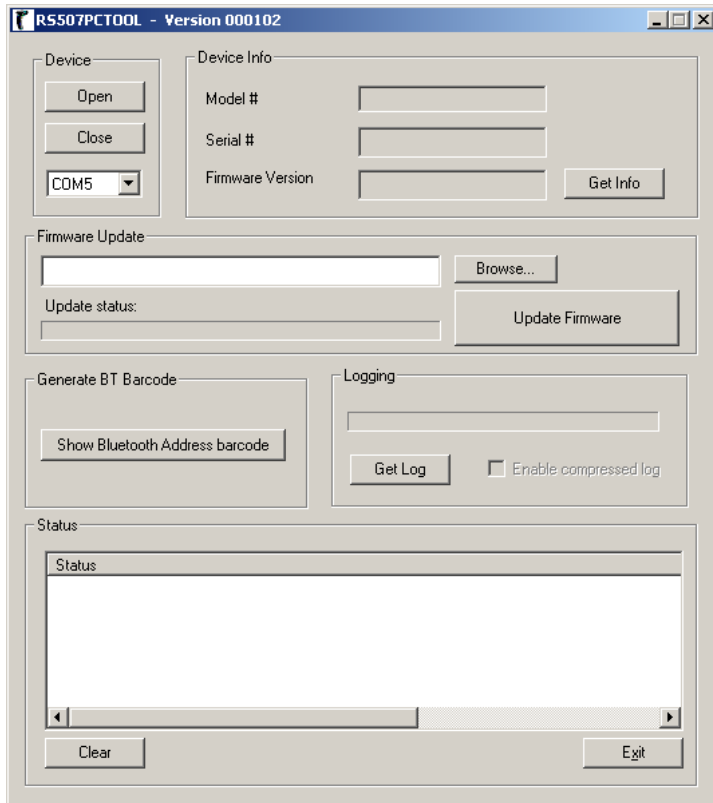

12. Click the **Show Bluetooth Address barcode** button.
13. Manually enter the BD address to the PC Tool application and click the **Generate** button.

Figure 26 SPP - PC Tool Application - Barcode Generator

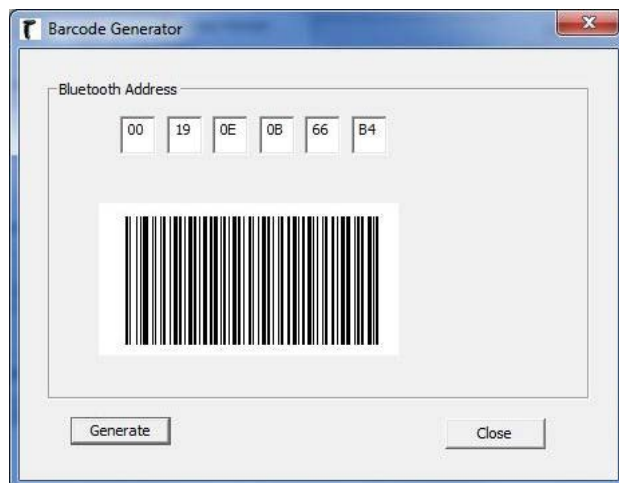

14. Click **Close**.
15. Open the incoming COM port assigned (for example, COM7) in the application. After the COM port is opened the computer connects to the RS5100 and a beep will sound. For demonstration, go to [General Bluetooth Options on page 61](#).



NOTE: If the COM port is not opened prior to the connection, the RS5100 will fail to connect.

16. To start the connection process aim the RS5100 at about 7" (18 cm) away from the computer screen and scan the barcode of the BD address of the computer (or the other target device).

The RS5100 Scan LEDs start flashing green indicating that the RS5100 is attempting to establish connection with the computer. The following notifications display upon successful connection.

Figure 27 SPP - Device Successfully Added Screen

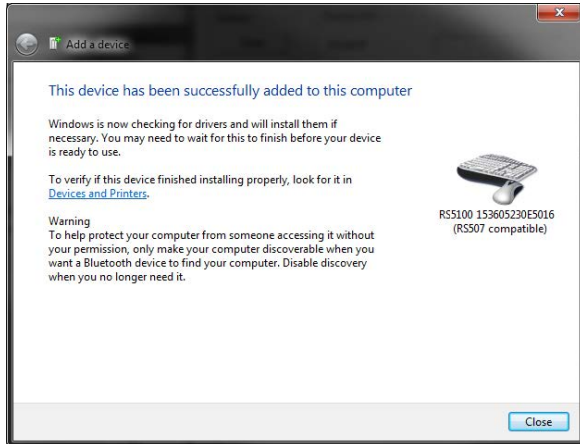

Windows 7

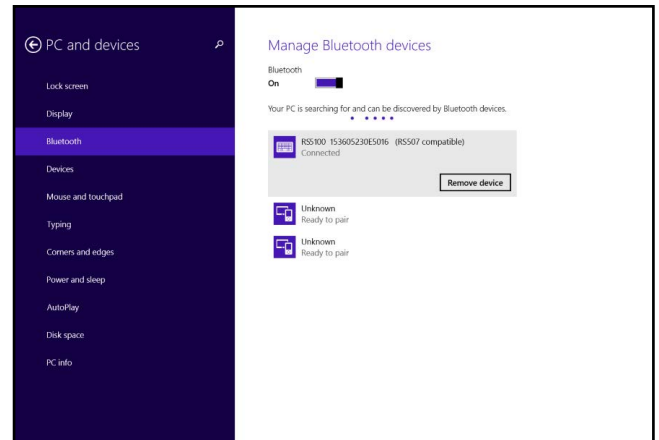

Windows 8

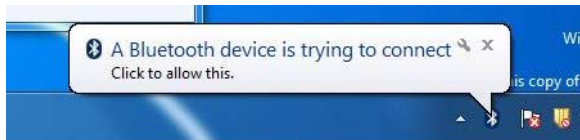

NOTE: In case you do not hear the connected beep on the RS5100, press the RS5100 **Restore key** to connect.

SPP Bluetooth Connection to Windows 7 or 8 as Peripheral

1. Perform clean boot. Go to [Clean Boot on page 22](#).
2. Scan the SPP Bluetooth Classic (discoverable) barcode.
3. Perform a Cold Boot by removing and re-installing the battery onto the RS5100. The RS5100 starts to operate and is discoverable as a Bluetooth serial device.
4. Right click the Bluetooth icon and select **Add a Device** (Windows 7) or **Add a Bluetooth Device** (Windows 8).

Figure 28 SPP connection with RS5100 as a Peripheral - Open Settings

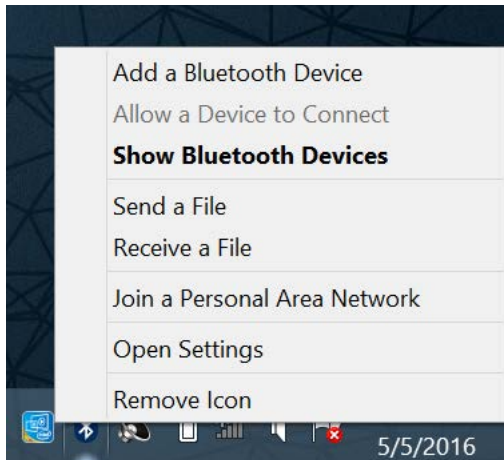

5. Select the RS5100 (see Bluetooth Camera icon below) and click **Next**

Figure 29 SPP connection with RS5100 as a Peripheral - Add Device Screen

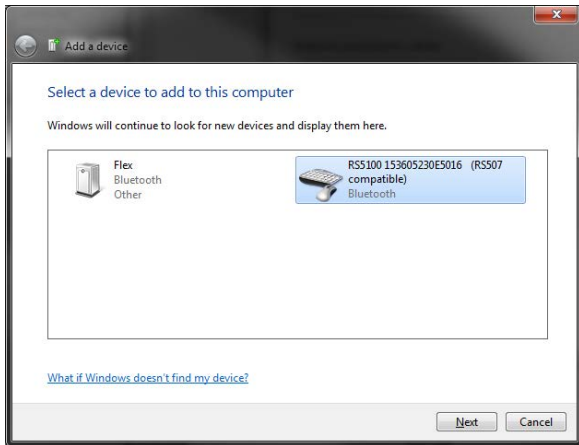

Windows 7

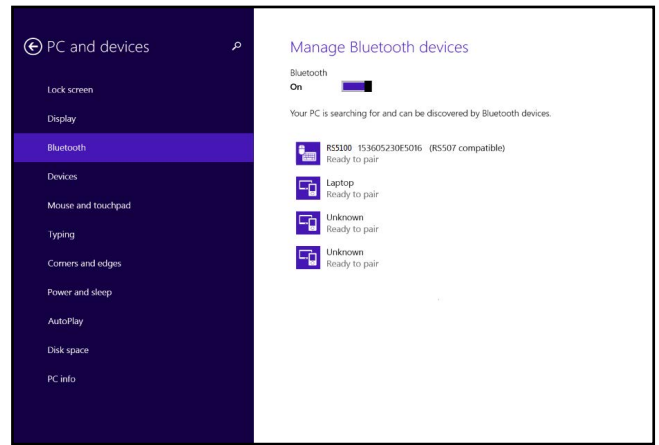

Windows 8

6. The computer attempts to connect to the RS5100

Figure 30 SPP connection with RS5100 as a Peripheral - Device Successfully Added Screen

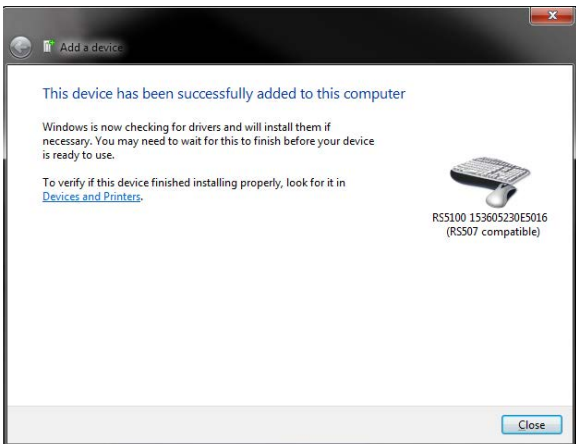

Windows 7

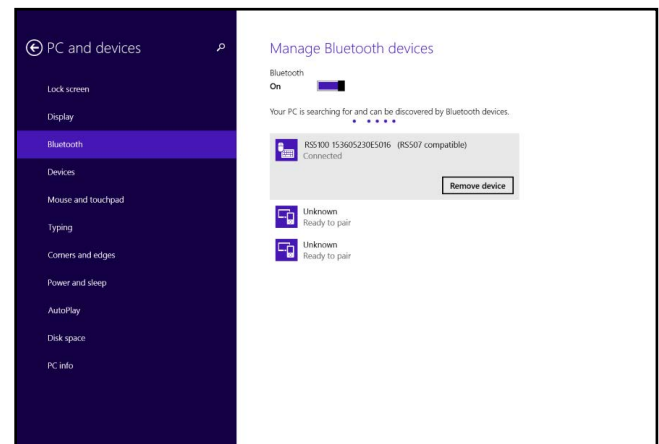

Windows 8

7. Open the incoming COM port assigned (for example, COM7) in the application. After the COM port is opened the computer connects to the RS5100 and a beep will sound. For a demonstration, go to [General Bluetooth Options on page 61](#).



NOTE: Make sure the same COM port is closed in other applications.

How to Demonstrate SPP Connection with a Computer

Once SPP connection is established, an application is required to demonstrate the RS5100.

To scan a barcode:

1. If the RS5100 is still connected to the PC Tool application, close the COM port on the PC Tool application.
2. Run a hyper terminal application such as the Tera Term application. (ayera.com/teraterm/download.cfm).

Figure 31 Tera Term Application Screen

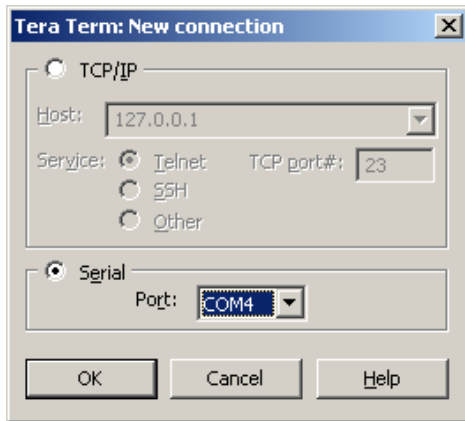

3. Select the virtual COM port set for the RS5100 connection.
4. Scan barcodes. Successful decoding of a barcode is indicated by one green flash of the **Scan LEDs** and a high beep sound. In case of Bluetooth disconnection, the RS5100 emits one high beep followed by four low beeps.

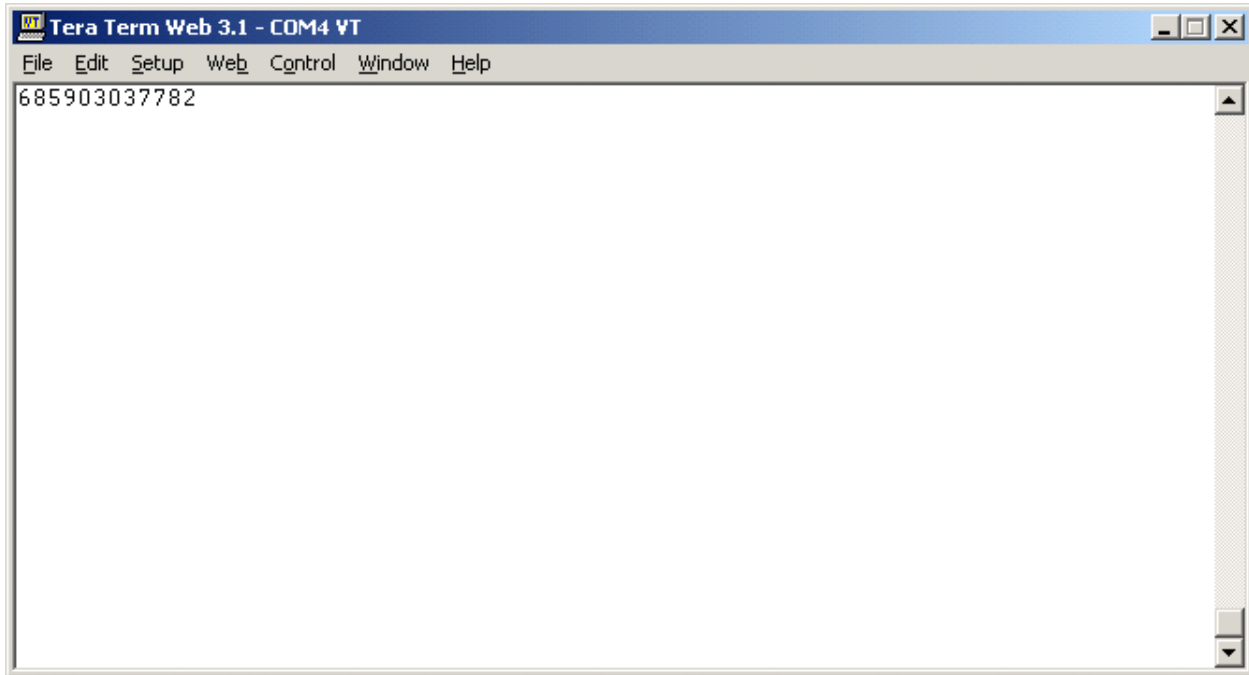

Figure 32 Tera Term Entry Screen

Special characters

SPP mode supports special characters that trigger actions when sent from the computer.

Table 3 Special Characters

Character	ASCII	Action
BELL	0x07	If Bell Indication is enabled, performs the configured Bell Indication.
Serial	0x73	Sends the serial number of the RS5100.
Image Capture Mode	0x69	Activates Image Capture mode.
Custom notification 1	0x79	Performs custom notification sequence 1.
Custom notification 2	0x63	Performs custom notification sequence 2.
Scanner enable	0x65	Enables scanner.
Scanner disable	0x64	Disables scanner.

Beep on BELL Character

Parameter # 150

When this parameter is enabled, the RS5100 issues a beep when a <BEL> character is received over the SPP connection to the host device.



NOTE: This parameter only applies to SPP (Serial Port Profile).

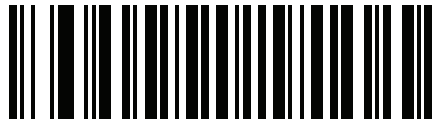

*Beep on <BEL> Enable

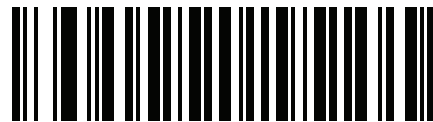

Beep on <BEL> Disable

Bell Indication Control

The BELL Indication Control parameter configures the beep tone sequence of the bell indication when a BELL character is received. This feature is valid only in SPP mode for PC connection.



GP_1_HI_SHORT



GP_2_HI_SHORT



GP_3_HI_SHORT



GP_4_HI_SHORT



GP_5_HI_SHORT



GP_1_LO_SHORT



GP_2_LO_SHORT



GP_3_LO_SHORT



GP_4_LO_SHORT



GP_5_LO_SHORT



GP_1_HI_LONG

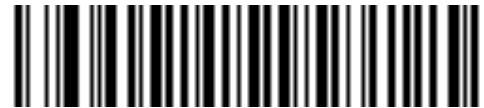

GP_2_HI_LONG



GP_3_HI_LONG

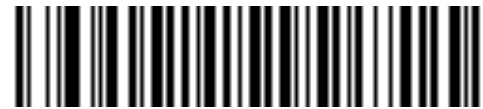

GP_4_HI_LONG



GP_5_HI_LONG



GP_1_LO_LONG



GP_2_LO_LONG



GP_3_LO_LONG



GP_4_LO_LONG



GP_5_LO_LONG



GP_FAST_WARBLE



GP_SLOW_WARBLE



GP_HI_LO



GP_LO_HI



GP_HI_LO_HI



GP_LO_HI_LO



GP_HI_HI_LO_LO



APP_ERROR_BEEP



APP_CLICK



LOW_CLICK

General Bluetooth Options

Default Bluetooth Friendly Name

Parameter # 1701

Select default Bluetooth Friendly Name.

- Select **RS5100** for pairing with Host device, in SSI mode, that supports RS5100. The Friendly Name becomes **RS5100 <serial number>**.
- Select **RS5100 and RS6000** for pairing with old Host device, in SSI mode, that does not support RS5100. The Friendly Name becomes **RS5100 <serial number> (RS6000 compatible)**



NOTE: When you change this parameter, the RS5100 needs to be rebooted.



NOTE: If RS5100 is already paired to a Host device in 'RS5100' mode that doesn't have RS5100 support, then after you change the parameter to 'RS5100 and RS6000' mode, you need to reboot the Host device and pair again before it can function properly.



***RS5100
(0)**



**RS5100 and RS6000
(1)**

Discoverable Mode

Parameter # 610

Select a discoverable mode based on the device initiating discovery:

- Select **General Discoverable Mode** when initiating connection from a PC.
- Select **Limited Discoverable Mode** when initiating connection from a PC or mobile device, and the RS5100 does not appear in General Discoverable Mode. Note that it can take longer to discover the device in this mode.

The RS5100 remains in Limited Discoverable Mode for 30 seconds, and the blue LED flashes while in this mode. It is then non-discoverable. To re-activate Limited Discoverable Mode, press the trigger.



***General Discoverable Mode
(0)**

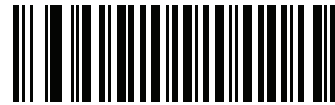

**Limited Discoverable Mode
(1)**

Bluetooth Security

The RS5100 supports Bluetooth authentication. Authentication can be requested by either the remote device or the RS5100.



NOTE: A remote device can still request authentication.

PIN Code

Parameter # 552



NOTE: The default PIN code is 12345.

To set and store a PIN code (e.g., password) on the RS5100 to connect to the host:

1. Scan the **Set & Store PIN Code** barcode below.
2. Scan five alphanumeric programming barcodes using the alphanumeric barcodes beginning on page [333](#).
3. Scan **End of Message** on page [341](#).

If the RS5100 communicates with a remote device with security enabled, synchronize the PIN codes on the RS5100 and remote device. To achieve this, connect the RS5100 to the host when setting the PIN codes. If the RS5100 is not connected to a host, the PIN code change only takes affect on the RS5100. If is required between the RS5100 and host, and the PIN codes do not match, pairing fails.



NOTE: An extended 16 character PIN code is available for additional security with Open Bluetooth (SPP and HID).

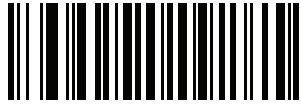

Set and Store PIN Code

Variable PIN Code

Parameter # 608

When connecting to a host device with authentication enabled, scan **Static PIN Code** below to avoid entering the PIN code manually. The PIN stored in memory is used. Scan the **Variable PIN Code** below to manually enter a PIN code with each connection.

The default PIN code is the user-programmed PIN set and stored above. Typically, however, HID connections require entering a Variable PIN Code. If, when attempting connection, the application presents a text box that includes a PIN, scan the **Variable PIN Code** barcode, then re-attempt connection. When you hear a beep indicating the RS5100 is waiting for an alphanumeric entry, enter the provided variable PIN using the [Alphanumeric and Numeric Barcodes on page 333](#), then scan **End of Message** on page 341 if the code is less than 16 characters. The RS5100 discards the variable PIN code after connection.



***Static PIN Code
(0)**



**Variable PIN Code
(1)**

Bluetooth Security Levels

Parameter # 1393

- **Low Bluetooth Security** - The low security setting is designed for ease of connection with most devices. This setting may be unacceptable to some devices. If connection fails, try re-connecting after increasing security setting on the RS5100.

If connecting to Bluetooth 2.1 device and above, Just Works method for secure and simple pairing is used.



NOTE: Data is encrypted using the **Low Bluetooth** security setting if connected to a Bluetooth 2.1 and above device.

- **Medium Bluetooth Security** - The medium security setting may require a passkey for the initial connection to pair RS5100 and device. If connecting to Bluetooth 2.1 device and above, *Passkey Entry* method for secure and simple pairing is used.

- **High Bluetooth Security** - The high security setting enables *Man in the Middle* protection for Bluetooth 2.1 and above. Not all devices are able to support this mode.
- **Legacy Bluetooth Security** (Bluetooth 2.0 and below) - The legacy security setting enables authentication and encryption for legacy pairing.

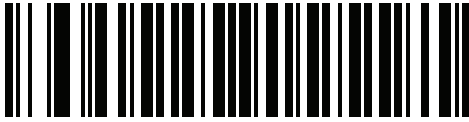

***Low Bluetooth Security**

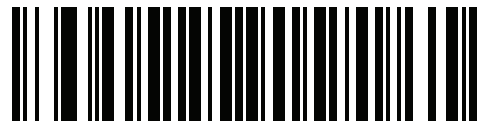

Medium Bluetooth Security

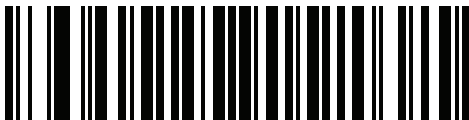

High Bluetooth Security



Legacy Bluetooth Security

Wi-Fi Friendly Mode

Scanners configured for Wi-Fi friendly mode behave as follows:

- The RS5100 remains in sniff mode, and exits sniff mode only during firmware update.
- If any Wi-Fi channel is excluded from the hopping sequence, AFH turns off.
- RS5100 avoid the selected Wi-Fi channels after establishing connection.

Notes

- If using this feature, configure all RS5100 in the area for Wi-Fi friendly mode.
- By default, no Wi-Fi channels are excluded.
- Since Bluetooth requires a minimum of 20 channels when Wi-Fi channels 1, 6, and 11 are excluded, a smaller number of channels are cut from the hopping sequence.
- Updating Wi-Fi friendly settings before Bluetooth connection is recommended.

Scan a barcode below to enable or disable **Wi-Fi Friendly Mode**, then use [Wi-Fi Friendly Channel Exclusion](#) to select any channels to exclude.



***Disable Wi-Fi Friendly Mode**

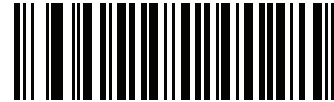

Enable Wi-Fi Friendly Mode

Wi-Fi Friendly Channel Exclusion

Select the channels to exclude:

- **Exclude Wi-Fi channel 1:** Bluetooth channels 0-21 are excluded from hopping sequence (2402-2423 MHz).
- **Exclude Wi-Fi channel 6:** Bluetooth channels 25-46 are excluded from hopping sequence (2427 - 2448 MHz).
- **Exclude Wi-Fi channel 11:** Bluetooth channels 50-71 are excluded from hopping sequence (2452 - 2473 MHz).
- **Exclude Wi-Fi channel 1, 6 and 11:** Bluetooth channels 2-19 (2404-2421 MHz), 26-45 (2428 - 2447 MHz) and 51-69 (2453 - 2471 MHz) are excluded from hopping sequence.
- **Exclude Wi-Fi channels 1 and 6:** Bluetooth channels 0-21 (2402-2423 MHz) and 25-46 (2427 - 2448 MHz) are excluded from hopping sequence.
- **Exclude Wi-Fi channels 1 and 11:** Bluetooth channels 0-21 (2402-2423 MHz) and 50-71 (2452 - 2473 MHz) are excluded from hopping sequence.
- **Exclude Wi-Fi channel 6 and 11:** Bluetooth channels 25-46 (2427 - 2448 MHz) and 50-71 (2452 - 2473 MHz) are excluded from hopping sequence.

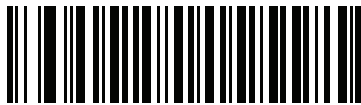

***Use All Channels (Standard AFH)**



Exclude Wi-Fi Channel 1



Exclude Wi-Fi Channel 6

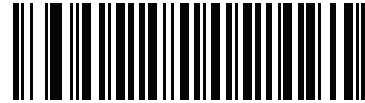

Exclude Wi-Fi Channel 11

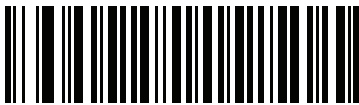

Exclude Wi-Fi Channels 1, 6, and 11

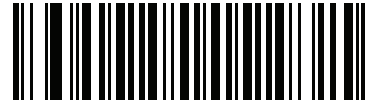

Exclude Wi-Fi Channels 1 and 6



Exclude Wi-Fi Channels 1 and 11



Exclude Wi-Fi Channels 6 and 11

Radio Output Power

Parameter # 1324

RS5100 uses a configurable radio which can be configured to operate in:

- Low power mode as a Class 2 device
- High power mode as Class 1 device.

Increase the radio output power to increase range. Scan a barcode to select the desired power mode.

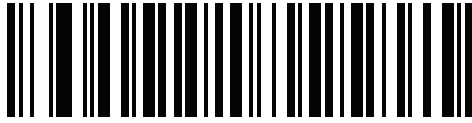

***Class 2 (Low Power)**

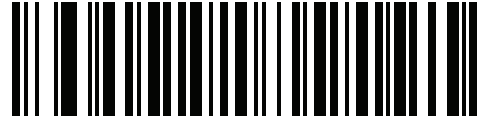

Class 1 (High Power)

Link Supervision Timeout

Parameter # 1698

Link supervision timeout controls how quickly the RS5100 senses that the Bluetooth radio lost connection to the remote device. A lower value helps prevent data loss at the edge of the operating range while a larger value helps prevent disconnects due to the remote device not responding in time. If you are experiencing occasional disconnects and the RS5100 is able to reconnect, increase the link supervision timeout value.



NOTE: The RS5100 only controls Link Supervision Timeout in Central mode.

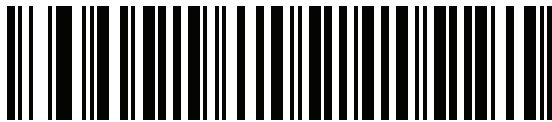

0.5 Seconds

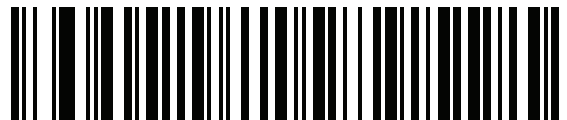

***2 Seconds**

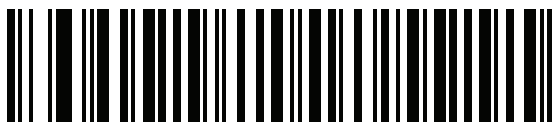

5 Seconds

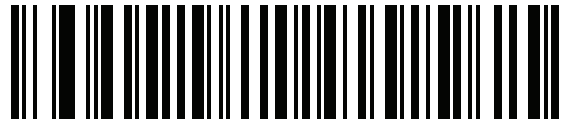

10 Seconds

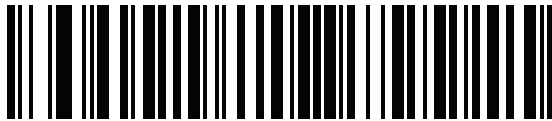

20 Seconds

Reconnecting

When in SPP Central, SSI Bluetooth Classic, and Bluetooth HID, the RS5100 automatically tries to reconnect to a remote device when a disconnection occurs that is due to the radio losing communication. This can happen if the RS5100 goes out of range with the remote device, or if the remote device powers down. The RS5100 initiates auto-reconnect based on the Auto-Reconnect setting. The duration of the auto-reconnect attempt is specified by the Reconnect Attempt Interval setting. During reconnection, the Status LED blinks blue.

If the auto-reconnect process fails due to:

- Page Time-Outs - The RS5100 sounds a page timeout beep (long low/long high) and enters low power mode.
- Connection Attempt Rejected - The RS5100 sounds a connection reject beep sequence (go to [Status Indications on page 12](#)) and enters low power mode.



NOTE: If a barcode is scanned while the auto-reconnect sequence is in process, a transmission error beep sequence sounds and the data is not transmitted to the host. After a connection is reestablished, normal scanning operation returns.

Switching between Bluetooth host types by scanning a host type barcode causes the radio to be reset. Scanning is disabled during this time. It takes several seconds for the RS5100 to re-initialize the radio at which time scanning is enabled.

Restore Lost Bluetooth Connection

If the auto-reconnect process fails and times out, the Bluetooth connection is re-established as follows:

1. Ensure that the RS5100 is within a range of 10 meters (30 feet) from the mobile computer.
2. Ensure that the mobile computer is on and “awake” (not in Suspend mode).
3. Briefly press the Restore Key on the RS5100 to initiate the reconnect process.
4. The Status LED starts flashing blue indicating that the RS5100 is attempting to establish connection with a mobile computer. The Status LED turns off and the RS5100 emits one string of low/high beeps indicating that the RS5100 is connected and ready for scanning.

Reconnect Attempt Beep Feedback

Parameter # 559

When the RS5100 disconnects as it goes out of range, it immediately attempts to reconnect. While the RS5100 attempts to reconnect, the Status LED continues to blink blue. If the auto-reconnect process fails, the RS5100 emits a page timeout beep (long low/long high) and the Status LED stops blinking. The process can be restarted by pulling the trigger or pressing the restore key.

The Beep on Reconnect Attempt feature is disabled by default. When enabled, the RS5100 emits five short high beeps every five seconds while the re-connection attempt is in progress. Scan a barcode below to enable or disable Beep on Reconnect Attempt.



***Disable Beep on Reconnect Attempt
(0)**



**Enable Beep on Reconnect Attempt
(1)**

Reconnect Attempt Interval

Parameter # 558

When a RS5100 disconnects as it goes out of range, it immediately attempts to reconnect for the default time interval of 30 seconds. This time interval can be changed to one of the options below.

To set the Reconnect Attempt Interval, scan one of the barcodes below.



***Attempt to Reconnect for 30 Seconds
(6)**



**Attempt to Reconnect for 1 Minute
(12)**



Attempt to Reconnect for 5 Minutes
(60)



Attempt to Reconnect for 30 Minutes
(360)



Attempt to Reconnect for 1 Hour
(720)



Attempt to Reconnect for 2 Hours
(1440)



Attempt to Reconnect Indefinitely
(0)

Auto-reconnect

Parameter # 604

In Bluetooth Keyboard Emulation (HID) mode, SPP Central, and SSI Bluetooth Classic, select a re-connect option for when the RS5100 loses its connection with a remote device:

- **Auto-reconnect on Barcode Data:** The RS5100 auto-reconnects when you scan a barcode. With this option, a delay can occur when transmitting the first characters. The RS5100 sounds a decode beep upon barcode scan, followed by a connection, a page timeout, a rejection beep, or a transmission error beep. Select this option to optimize battery life on the RS5100 and mobile device. Note that auto-reconnect does not occur on rejection commands.
- **Auto-reconnect Immediately:** When the RS5100 loses connection, it attempts to reconnect. If a page timeout occurs, the RS5100 attempts reconnect by pulling the trigger or pressing the restore key. Select this option if the RS5100 battery life is not an issue and you do not want a delay to occur when the first barcode is transmitted. Note that auto-reconnect does not occur on rejection commands.

- **Disable Auto-reconnect:** When the RS5100 loses connection, you must re-establish it manually.



**Auto-reconnect on Barcode Data
(1)**

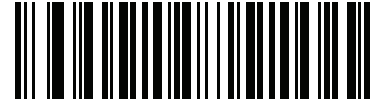

***Auto-reconnect Immediately
(2)**

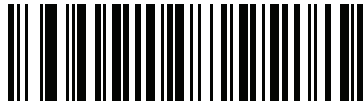

**Disable Auto-reconnect
(0)**

Pairing Support

Toggle Pairing

Parameter # 1322

If the RS5100 is configured for Toggle Pairing, scanning a pairing barcode a second time will unpair the scanner.

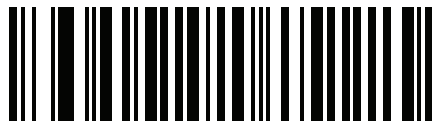

***Toggle Pairing Disable**

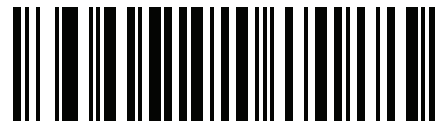

Toggle Pairing Enable

Force Pairing Save

The Force Pairing Save parameter enables/disables saving the remote Bluetooth address after each Bluetooth connection attempt.

When this parameter is disabled, the Bluetooth address is saved only after a successful Bluetooth connection. If the Bluetooth connection fails, the Bluetooth address is not saved.



NOTE: This parameter is effective when the RS5100 connects as Central.



Disable



***Enable**

Auto Un-Pairing

Parameter # 1708

The auto un-pair parameter configures the RS5100 to un-pair from the host computer on specific events.

- **Disable (default)** - the RS5100 will not auto un-pair on any events.
- **On cradle insertion** - the RS5100 will un-pair when inserted charging cradle
- **On reset** - the RS5100 will un-pair if a warm or cold reset occurs
- **On cradle or reset** - the RS5100 will un-pair on cradle insertion or reset event.



***Disable**



Un-pair on Cradle Insertion



On Reset

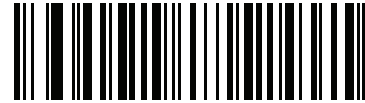

On Cradle or Reset

Pairing Barcode Format

When pairing the RS5100 to certain host devices in SSI Bluetooth Classic, SPP Bluetooth Central or Bluetooth HID, it is necessary to create a pairing barcode. The RS5100 scans the pairing barcode and initiates the connection to the host computer. To create a pairing barcode label, the Bluetooth address of the remote device must be known (refer to the mobile computer user guide).

Pairing barcodes are Code 128 or Data Matrix symbologies formatted as follows:

<Fnc 3>Bxxxxxxxxxxx

where:

- **B** (or **LNKB**) is the prefix
- xxxxxxxxxxxx represents the 12-character Bluetooth address.

Pairing Barcode Example

If the mobile computer Bluetooth address is 11:22:33:44:55:66, then the pairing barcode is:



Figure 33 Creating a Pairing Bluetooth Barcode

Unpairing

Unpair the RS5100 from the host computer to make the host computer available for pairing with another RS5100. Scan the barcode below to disconnect the RS5100 from its host computer.



Unpairing

Batch Mode

Parameter # 544



IMPORTANT: Batch mode only applies for HID and SPP Central Mode.

The RS5100 supports five versions of batch mode. When the RS5100 is configured for any of the batch modes, it attempts to store barcode data (not parameter barcodes) until transmission is initialized, or the maximum number of barcodes are stored. When a barcode is saved successfully, a good decode beep sounds and the LED flashes green. If the RS5100 is unable to store a new barcode, a low/high/low/high out of memory beep sounds. (go to page 12 for all beeper and LED definitions.)

In all modes, calculate the amount of data (number of barcodes) the RS5100 can store as follows:

Number of storable barcodes = 9,000 bytes of memory / (number of characters in the barcode + 3).



NOTE: If the batch mode selection is changed while there is batched data, the new batch mode takes effect only after all the previously batched data is sent.

Modes of Operation

- **Normal (default)** - Do not batch data. The RS5100 attempts to transmit every scanned barcode.
- **Out of Range Batch Mode** - The RS5100 starts storing barcode data when it loses its connection to a remote device (for example, when a user holding the RS5100 walks out of range). Data transmission is triggered by re-establishing the connection with the remote device (for example, when a user holding the RS5100 walks back into range).
- **Standard Batch Mode** - The RS5100 starts storing barcode data after **Enter Batch Mode** is scanned. Data transmission is triggered by scanning **Send Batch Data**.



NOTE: Transmission is halted if the connection to the remote device is lost.

In all modes, transmissions are halted if the RS5100 is moved out of range. The RS5100 resumes when it is back in range. If a barcode is scanned while batch data is transmitted it is appended to the end of the batched data; parameter barcodes are not stored.



***Normal
(00h)**



**Out of Range Batch Mode
(01h)**



**Standard Batch Mode
(02h)**



Enter Batch Mode



Send Batch Data

Unique Identifier (SPP only)

When using Batch Mode, enable Unique Identifier to add the device serial number to each payload data sent in Batch Mode.



*Disable



Enable

Image Capture (SPP only)

Image Capture mode allows the RS5100 to capture an image and send the binary data over the SPP connection. The connected device uses the binary data, starting from the JPG signature (hex value **FF D8 FF**), to create the image file in JPG format.

To use Image Capture mode:

1. Change the RS5100 to SPP mode. Go to [Serial Port Profile on page 48](#).
2. Pair and connect the RS5100 to a device.
3. Enable Image Capture mode by sending the character **i** to the RS5100. Go to [Special characters on page 55](#).
The cross hair laser beam illuminates, indicating that the RS5100 is ready to capture an image.
4. Press the Scan trigger.

After capturing an image the RS5100 performs the following in order:

- Sends the data to the connected device
- Exits Image Capture mode

Returns to the previous barcode scanning mode.

Battery Threshold

- **Parameter # 1367: Battery Status Threshold.** This parameter defines the battery level at which the scanner battery indicator turns green (High Threshold). The default value is 50%.
- **Parameter # 1368: Battery Status Medium Threshold.** This parameter defines the battery level at which the scanner indicator turns amber. The default value is 20%.
- **Parameter # 1369: Battery Status Low Warning Threshold.** This parameter defines the battery status at which the scanner enters low warning mode and the scanner indicator turns red. In low warning mode, the scanner emits four short beeps after every trigger release. The default value is 10%.
- **Parameter # 1370: Battery Health Low Warning Threshold.** This parameter defines the battery health level at which the battery enters low health mode. In low health mode, all battery indications alternate between red and the appropriate battery status indication.

NOTE: When battery health is low, consider replacing the battery.

To set each threshold, scan one of the following barcodes, and then scan two barcodes from [Numeric Barcodes](#) that correspond to the desired percentage from 00 to 99.



Battery Status High Threshold

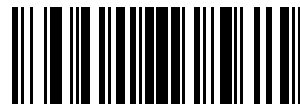

Battery Status Medium Threshold

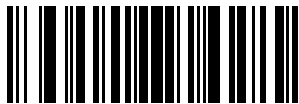

Battery Status Low Warning Threshold

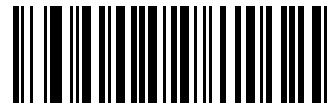

Battery Health Low Warning Threshold

Bluetooth Friendly Name

Parameter # 607

If the scanner was disabled previously by a PC/tablet/phone, it may take a while for the new name to appear as the PC/tablet/phone needs to update its list. Try turning the radio off and then on, or reboot your PC/tablet/phone.

You can set a meaningful name for the digital scanner that appears in the application in the application during device discovery. The default name is the scanner name followed by its serial number. Select **Set Defaults** operation.

If the application allows setting a device name, this takes precedence over the Bluetooth Friendly Name.

To create a Bluetooth Friendly Name, choose Bluetooth Friendly Name, and then scan up to 23 characters from Alphanumeric Barcodes. If the name contains less than 23 characters, scan this option after entering the name.

BLE Beacons

Beacon Upon Disconnection

Parameter # 2403

This parameter controls beacons when the scanner is disconnected from the host device.

NOTE: A scanner is still paired with its host device when it disconnects from the host. Go to [Bluetooth Connection on page 19](#) for more information.

- **Enable:** The scanner begins beacons when it disconnects from the host device.
- **Disable:** The scanner does not beacon when it disconnects from the host device.



Enable

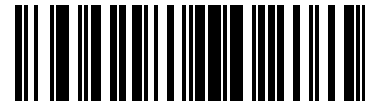

*Disable

Unpaired Beacons

Parameter #2404

This parameter controls beacons when the scanner is not paired to a host device.

- **Enable:** The scanner beacons if it is not paired to a host device. Any Bluetooth device can detect the beacon signal.
- **Disable:** The scanner does not beacon when it is not paired to a host device.



Enable



*Disable

Beaconing Beep

Parameter # 2405

This parameter controls beeping during beaconing.

If beaconing activates because of a low battery level, beeping is disabled to preserve battery power.



Enable

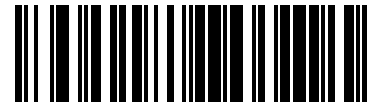

*Disable

Beacon Frequency

Parameter # 2406

This parameter defines how often the beacon signal is sent.

Scan the appropriate code to define how often the beacon emits a signal. The shorter interval provides more up-to-date information for tracking applications but has a more significant impact on battery life.

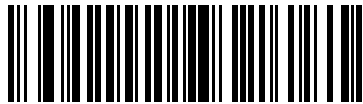

*100 ms

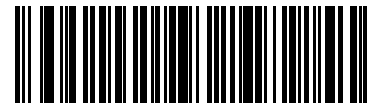

200 ms



500 ms

Beacon Battery Threshold

Parameter # 2407

This parameter defines the level the battery reaches when beaconing activates.

Scan one of the following codes to set the corresponding battery level. The recommended range is 0-40%.

When the scanner's battery reaches the defined level and beaconing activates, the scanner enters a power-saving mode. In the power-saving mode:

- pressing the trigger does not result in a scan
- sending data to and from the host device fails

To end power saving mode:

- place the scanner on a charger
- replace the battery with one that is more fully charged

NOTE: If the scanner's battery reaches 0%, there is no way to send a beacon signal to recover the scanner.



10%

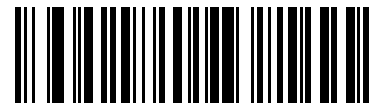

20%

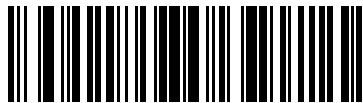

*30%



35%



37%

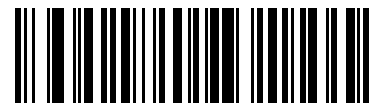

40%



Disable

Beacon ID

Parameters 2408 and 2409 comprise the Beacon ID in the Alt-Beacon packet.

ID1 is automatically generated and defined by Attribute 20036.

Parameter # 2408

This parameter sets the ID2 portion of the beacon ID.



0xE1E1 (1)



*0xEBEB (0)

Parameter # 2409

This parameter sets the ID2 portion of the beacon ID.



0XE2E2 (1)



*0XECDD (0)

Accessories

Accessories

Table 4 Accessories

Accessory	Part Number	Description
Cradles		
RS5100/6100 2-Bay Charger	CRD-RS5X6-2SCHG-01	Charges up to two devices with batteries. Additional shim attachment (p/n SHIM-CRD-R5X62B-01) charges a spare battery. Requires Power Supply PWR-WUA5V12W0US, USB A to USB C cord.
4-Slot RS5100 Charge Only Cradle	CRD-RS51-4SCHG-01	Charges up to four devices with batteries. Requires Power Supply PWR-BGA12V50W0WW, DC Line Cord CBL-DC-388A1-01 and Country Specific 3 wire AC Line Cord.
20-Slot RS5100 Charge Only Cradle	CRD-RS51-20SCHG-01	Charges up to twenty devices with batteries. Requires Power Supply PWR-BGA12V50W0WW, DC Line Cord CBL-DC-388A1-01 and Country Specific 3 wire AC Line Cord.
WT6000 / RS5100 5 Slot Charge Only Sharecradle	CRD-4WT6-4RS51-01	WT6000 / RS5100 5 Slot Charge Only Sharecradle, Allows Charging of 4 WT6000 Terminals, 4 WT6000 Spare Batteries and 4 RS5100 Ring Scanners.
TC5x / RS5100 5 Slot Charge Only Sharecradle	CRD-4TC5-4RS51-01	TC5x / RS5100 5 Slot Charge Only Sharecradle, Allows Charging of 4 TC5x Terminals and 4 RS5100 Ring Scanners.
Batteries and Chargers		
Replacement Standard Battery	BTRY-RS51-4MA-01	Replacement standard battery for RS5100 (single pack).
Replacement Standard Battery	BTRY-RS51-4MA-10	Replacement standard battery for RS5100 (ten pack).
Replacement Standard Battery	BTRY-RS51-4MA-CN	Replacement standard battery for RS5100, China only.

Accessories

Table 4 Accessories (Continued)

Accessory	Part Number	Description
Replacement Standard Battery	BTRY-RS51-4MA-02	Replacement standard battery for RS5100, India and South Korea only.
Replacement Extended Battery	BTRY-RS51-7MA-01	Replacement extended battery for RS5100 (single pack).
Replacement Extended Battery	BTRY-RS51-7MA-10	Replacement extended battery for RS5100 (ten pack).
Replacement Extended Battery	BTRY-RS51-7MA-02	Replacement extended battery for RS5100, India and South Korea only.
8-Slot Battery Charger	SAC-RS51-8SCHG-01	Charges up to eight spare batteries. Requires Power Supply PWR-BGA12V50W0WW, DC Line Cord CBL-DC-388A1-01 and Country Specific 3 wire AC Line Cord.
40-Slot Battery Charger	SAC-RS51-40SCHG-01	Charges up to forty spare batteries. Requires Power Supply PWR-BGA12V50W0WW, DC Line Cord CBL-DC-388A1-01 and Country Specific 3 wire AC Line Cord.
Triggers and Soft Goods		
Replacement Trigger Assembly	SG-RS51-TRGSS-01	RS5100 replacement Single Sided Trigger. Includes comfort pad and nylon strap.
Replacement Finger Strap	SG-RS51-STRPNY-10	RS5100 replacement Spare nylon finger straps for single sided trigger (10-pack).
Replacement Comfort Pad	SG-RS51-CMPD-05	RS5100 replacement comfort pads, to be used with single sided trigger (5-pack).
Replacement Trigger Assembly - Double Trigger: Standard Charge Contacts	SG-RS51-TRGDS-01	RS5100 replacement Double Sided Trigger. Replacement straps for double trigger (SG-RS51-STRPDT-10).
Replacement Trigger Assembly - Double Trigger: Standard Charge Contacts and Vibrator option	SG-RS51-TRGDV-01	RS5100 replacement Double Sided Trigger with vibrator. Replacement straps for double trigger (SG-RS51-STRPDT-10).
Replacement Trigger Assembly - Double Trigger: USB-C Charge Port	SG-RS51-TRGDU-01	RS5100 replacement Double Sided Trigger with USB-C. USB-C port on assembly allows the RS5100 to be charged via a USB cable and also allows for programming using 123Scan. Replacement straps for double trigger (SG-RS51-STRPDT-10).
Back of Hand Adapter	SG-RS51-BHMT-01	Back of Hand Mount, includes hand strap. Allows the RS5100 to be worn on the back of hand and provides a remote finger trigger. One size fits all; ambidextrous.

Accessories

Table 4 Accessories (Continued)

Accessory	Part Number	Description
Replacement Hand Strap	SG-RS51-BHSTP-01	Replacement strap for RS5100 back of hand mount.
Hand Mount - Left/Large	SG-RS51-HNMTLL-01	Hand Mount for RS5100, Left Hand Large, Includes Frame, Trigger and Hand Wrap.
Hand Mount - Left/Medium	SG-RS51-HNMTLM-01	Hand Mount for RS5100, Left Hand Medium, Includes Frame, Trigger and Hand Wrap.
Hand Mount - Left/Small	SG-RS51-HNMTLS-01	Hand Mount for RS5100, Left Hand Small, Includes Frame, Trigger and Hand Wrap.
Hand Mount - Right/Large	SG-RS51-HNMTRL-01	Hand Mount for RS5100, Right Hand Large, Includes Frame, Trigger and Hand Wrap.
Hand Mount - Right/Medium	SG-RS51-HNMTRM-01	Hand Mount for RS5100, Right Hand Medium, Includes Frame, Trigger and Hand Wrap.
Hand Mount - Right/Small	SG-RS51-HNMTRS-01	Hand Mount for RS5100, Right Hand Small, Includes Frame, Trigger and Hand Wrap.
Replacement Hand Wrap - Left/Large	SG-RS51-HNWPLL-01	Spare Hand Wrap for RS5100, Left Hand Large.
Replacement Hand Wrap - Left/Medium	SG-RS51-HNWPLM-01	Spare Hand Wrap for RS5100, Left Hand Medium.
Replacement Hand Wrap - Left/Small	SG-RS51-HNWPLS-01	Spare Hand Wrap for RS5100, Left Hand Small.
Replacement Hand Wrap - Right/Large	SG-RS51-HNWPRL-01	Spare Hand Wrap for RS5100, Right Hand Large.
Replacement Hand Wrap - Right/Medium	SG-RS51-HNWPRM-01	Spare Hand Wrap for RS5100, Right Hand Medium.
Replacement Hand Wrap - Right/Small	SG-RS51-HNWPRS-01	Spare Hand Wrap for RS5100, Right Hand Small.
Lanyard Trigger Assembly	SG-RS51-LNYD-01	Allows the RS5100 to be worn around the neck or hip. Requires separate purchase of the retractor with magnetic recoil (SG-RS51-RLYD1-01) for neck or hip mounting.
Retractor with Magnetic Recoil for Lanyard Trigger Assembly	SG-RS51-RLYD1-01	Allows RS5100 units with Lanyard Trigger Assembly (SG-RS51-LNYD-01) to be worn around the neck or hip. For use with RS51B0-LBLNWR, RS51B0-TBLNWR or SG-RS51-LNYD-01.
Other		
Bluetooth Adapter	BT-RS5X6-DNGL-01	Allows RS5100 to pair with a host computer via Bluetooth.

Charging

Use one of the accessories in the following table to charge the RS5100 and/or spare battery.

Table 5 Charging and Communication

Description	Part Number	Charging		Communication	
		Battery (In Device)	Battery Only	microUSB to USB	Ethernet
2-Bay Charge Only Charger	CRD-RS5X6-2SCHG-01	Yes	Yes	No	No
4-Slot RS5100 Charge Only Cradle	CRD-RS51-4SCHG-01	Yes	No	No	No
20-Slot RS5100 Charge Only Cradle	CRD-RS51-20SCHG-01	Yes	No	No	No
8-Slot Battery Charger	SAC-RS51-8SCHG-01	No	Yes	No	No
40-Slot Battery Charger	SAC-RS51-40SCHG-01	No	Yes	No	No

Charging the RS5100

To Charge the RS5100:

1. Insert the RS5100 into the RS5100 charging slot with the scan window facing the charge contacts.

Figure 34 Insert RS5100 Single Trigger and Double Trigger into Cradle

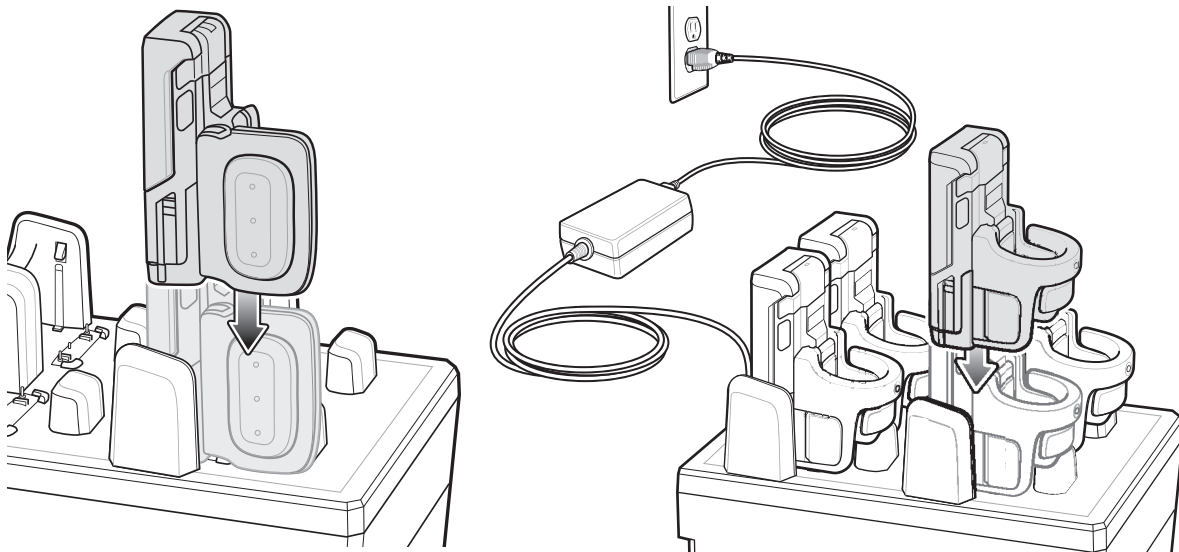

2. Ensure that the RS5100 is properly seated in the charging slot.



NOTE: It is suggested to charge the RS5100 before doing a firmware update over Bluetooth.

Charging the Spare Battery

1. Insert a spare battery into the spare battery slot.

Figure 35 Insert Battery into Cradle

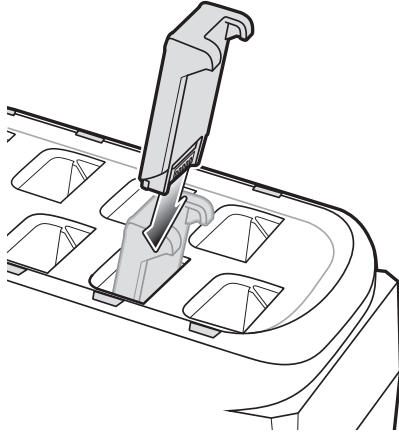

2. Ensure the battery is seated properly. The Spare Battery Charging LED blinks indicating charging.

Battery Charging

The RS5100 Charging LED indicates the charging status of the battery in the RS5100 and the Spare Battery Charging LED indicates the charging status of the spare battery. See [Table 6 on page 86](#).



NOTE: Brand new batteries from the factory are shipped in Ship Mode for protection, and need to be plugged into a charger (cradle or battery toaster) to activate the battery.

Table 6 Charging LED Indicators

State	Indication
Off	The battery is not charging. The RS5100 or battery is not inserted correctly in the cradle or connected to a power source. Cradle is not powered.
Solid Amber	Battery is charging.
Solid Green	Battery charging is complete.
Fast Blinking Red (2 blinks/second)	Charging error, e.g.: - Battery temperature is too low or too high for charging. - The battery has reached the charge cycle time-out period. Battery charging has gone on too long without completing a full charge cycle (typically eight hours).
Solid Red	Unhealthy battery is charging or fully charged.

Charge batteries in temperatures from 5°C to 40°C (41°F to 105°F). The standard battery charges from 0% to 90% in less than two and a half hours at room temperature. The extended battery charges from 0% to 90% in less than three and a half hours at room temperature. When the charging temperature is from 5°C to 10°C (41°F to 50°F), the standard battery charges in less than five hours. When the charging temperature is between 5°C and 10°C (41°F to 50°F), the extended battery charges in less than six hours.

The device and cradle monitor the battery temperature. Battery charging is only performed when the battery is within safe charging temperature limits. At higher temperatures (e.g. approximately +35 °C (+95 °F)) the device or charging cradle may for small periods of time alternately enable and disable battery charging to keep the battery at acceptable temperatures. This process may require additional time to complete a full charge cycle. The RS5100 or cradle indicate when charging is disabled due to abnormal temperatures via the Status LED.

2-Bay Charger

NOTE: Ensure that you follow the guidelines for battery safety described in [Battery Safety Guidelines on page 300](#).

The 2-Bay Charger:

Provides power for the operating the RS5100.

Charges up to two batteries in the RS5100.

Figure 36 2-Bay Charger

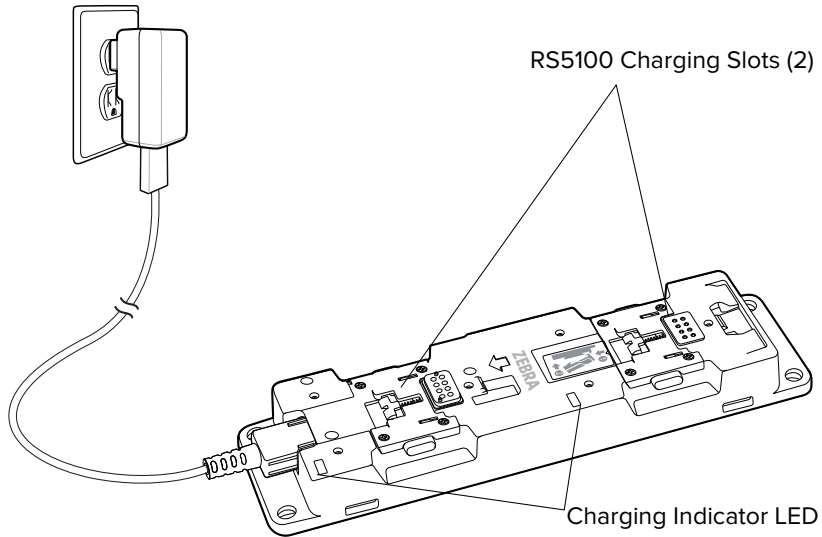
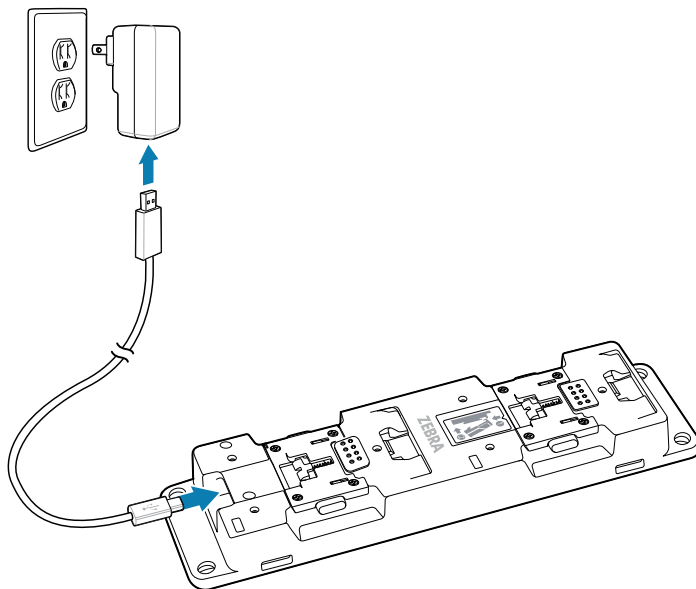

Figure 37 2-Bay Charger Setup



Accessories

Table 7 2-Bay Charger Accessories

Accessory Name	Part Number	Function
RS5100/6100 2-Bay Charger Mounting Bracket	BRKT-RS5X6-2SCHG-01	Mount up to five chargers together
RS5100/6100 Shim Attachment	SHIM-CRD-R5X62B-01	Charge spare batteries
Power Supply	PWR-WUA5V12W0XX	Supplies 100-240 VAC, 5 V, 2.5 A

Mounting the Charger onto a Bracket

Use the mounting bracket to mount up to five 2-Bay Chargers. The bracket may be mounted on a vertical surface.

Mount the 2-Bay chargers onto the bracket using four M5 7 mm long screws.

1. Align the mounting holes of the bracket and charger
2. Secure the charger in place with a screw in each mounting hole.

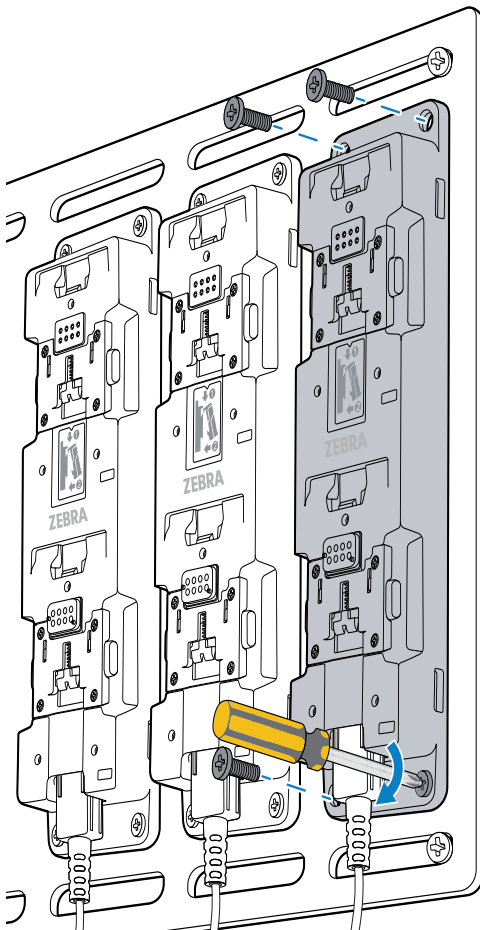

Shim Attachment

The Shim attachment allows the 2-Bay charger to charge spare batteries. Install one or two shim attachments to either charging bay.

1. Install the shim using the screws provided.

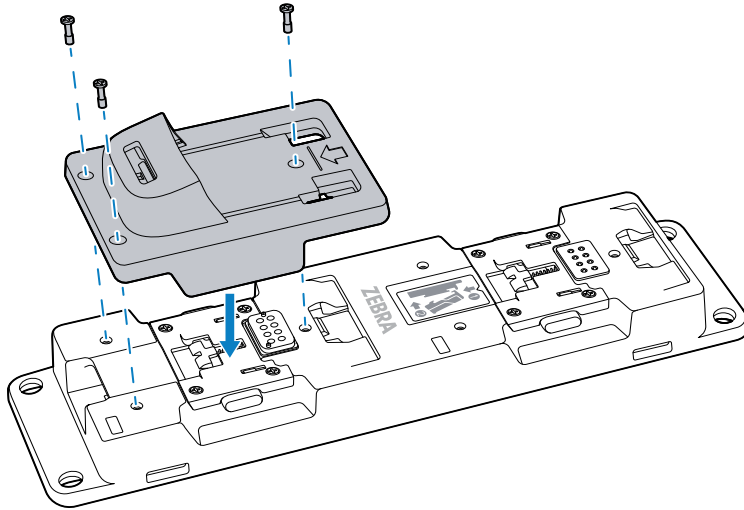

2. Insert a spare battery as shown. Press firmly until the battery latch clicks into place.
 - a. The charger's LED indicator illuminates when the battery is inserted successfully.

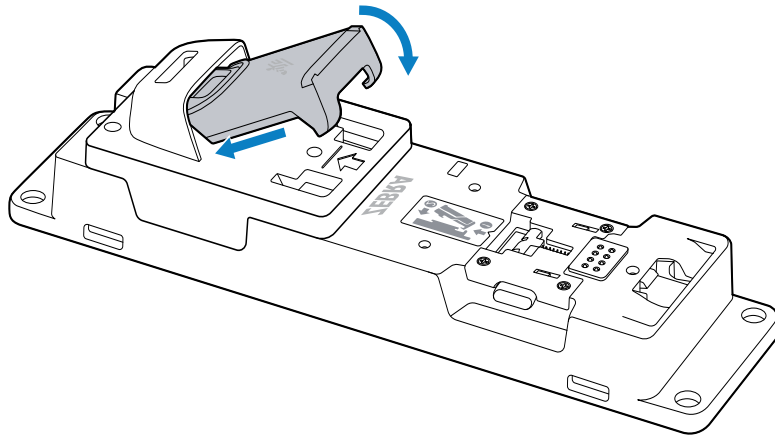

Table 8

Cradle LED	Indication
Amber	Charging healthy battery
Green	Spare battery is fully charged
Red	Charging/fully charged unhealthy battery
Red (blinking)	Charging fault or insufficient input
Off	No connection to battery or shim improperly connected to the charger

Power Supply

Zebra recommends connecting the USB-A end of the power cable to Zebra power supply (p/n PWR-WUA5V12W0XX). Use a power supply and outlet that provide at least 5 V, 1 A of power to the charger.

NOTE: If the 2-Bay Charger is connected to a power supply that provides less than 1 A, the charger will enter **low-current mode**. In **low current mode**:

- The top slot does not provide power to the charging slot. Its LED indicator blinks red.
- The bottom slot works as normal to charge a ring scanner or spare battery.

4-Slot RS5100 Charge Only Cradle



NOTE: Ensure that you follow the guidelines for battery safety described in [Battery Safety Guidelines on page 300](#).

The 4-Slot RS5100 Charge Only Cradle:

- provides power for operating the RS5100.
- charges up to four batteries in the RS5100.

Figure 38 4-Slot RS5100 Charge Only Cradle

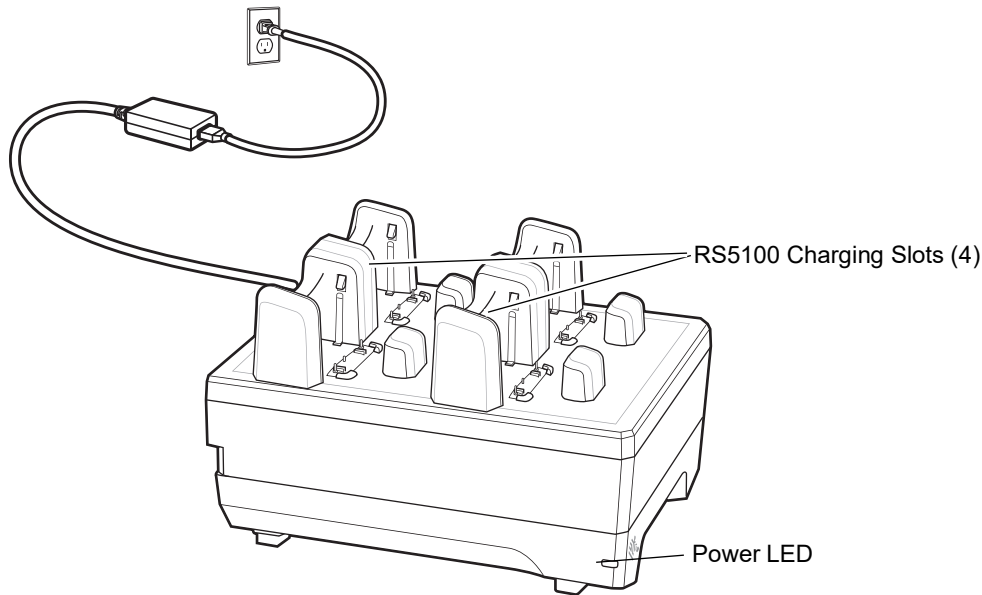
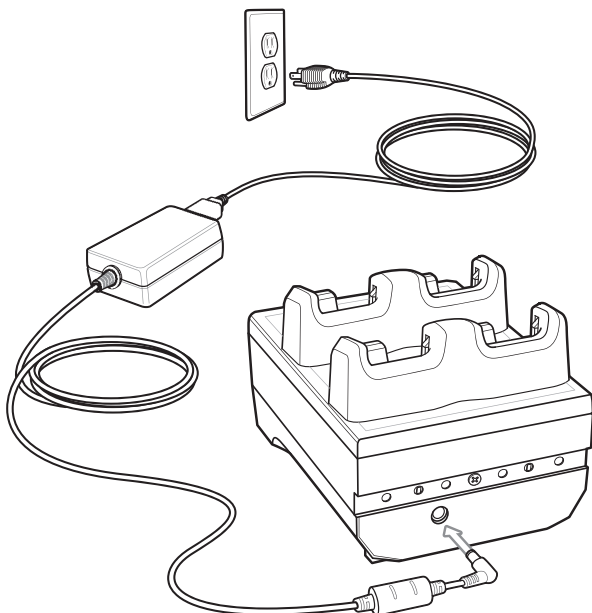

Figure 39 4-Slot RS5100 Charge Only Cradle Setup



8-Slot Battery Charger



NOTE: Ensure that you follow the guidelines for battery safety described in [Battery Safety Guidelines on page 300](#).

The 8-Slot Battery Charger charges up to eight spare batteries.

Figure 40 8-Slot Battery Charger

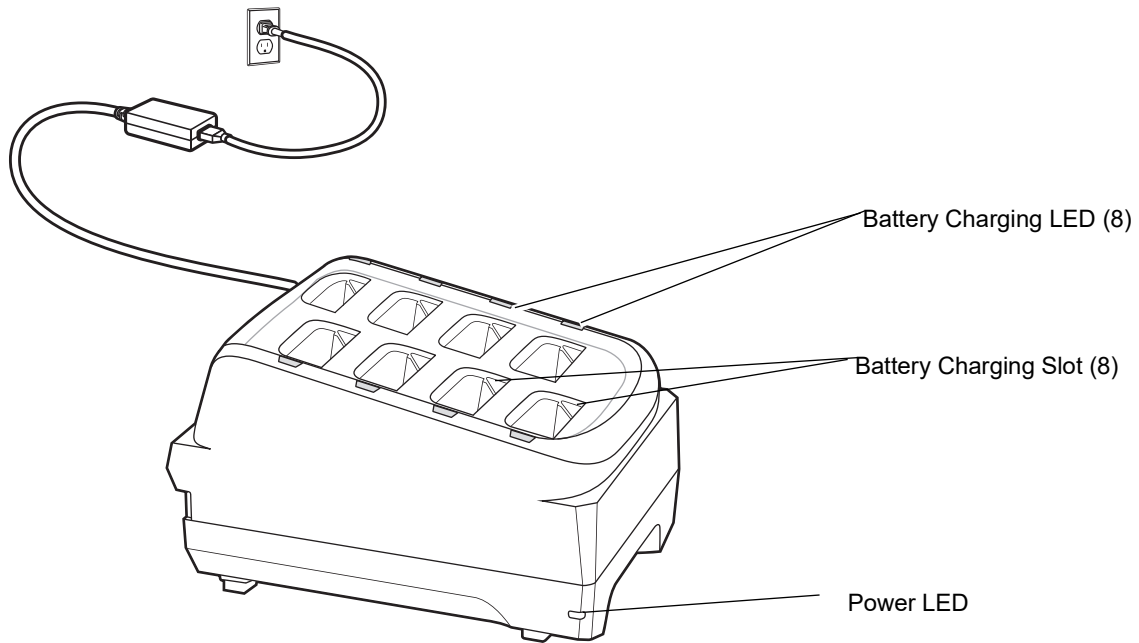
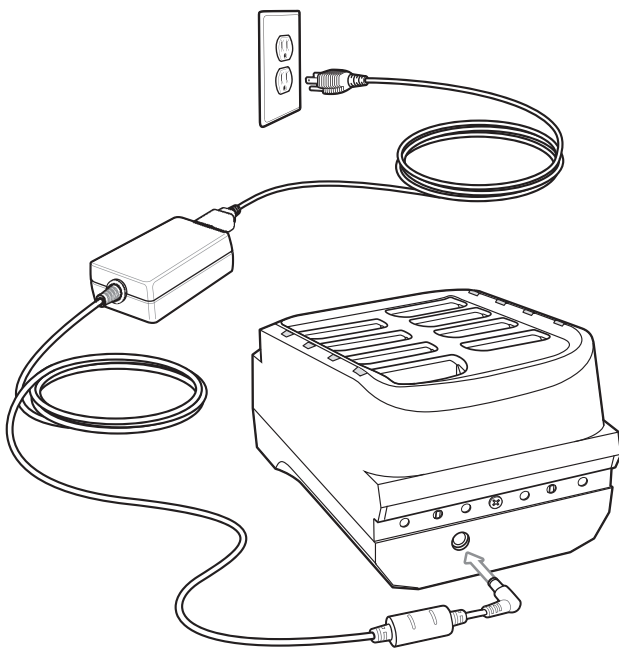

Figure 41 8-Slot Battery Charger Setup



20-Slot RS5100 Charge Only Cradle



NOTE: Ensure that you follow the guidelines for battery safety described in [Battery Safety Guidelines on page 300](#).

The 20-Slot RS5100 Charge Only Cradle:

- provides power for operating the RS5100.
- charges up to twenty batteries in the RS5100.

Figure 42 20-Slot RS5100 Charge Only Cradle

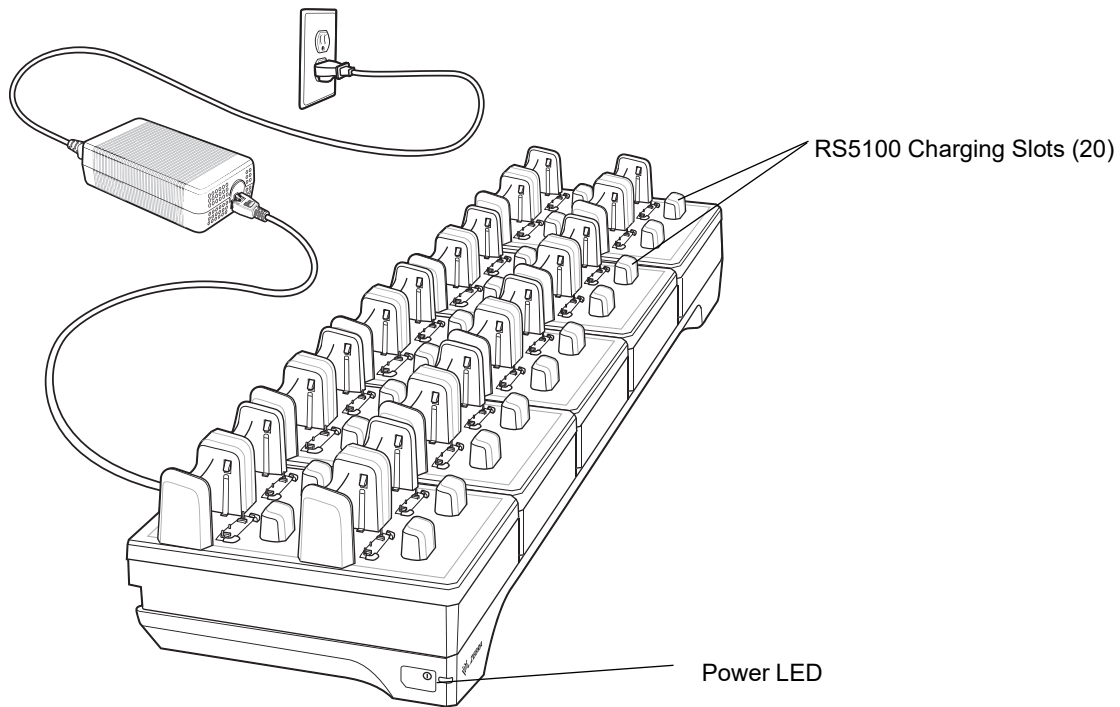
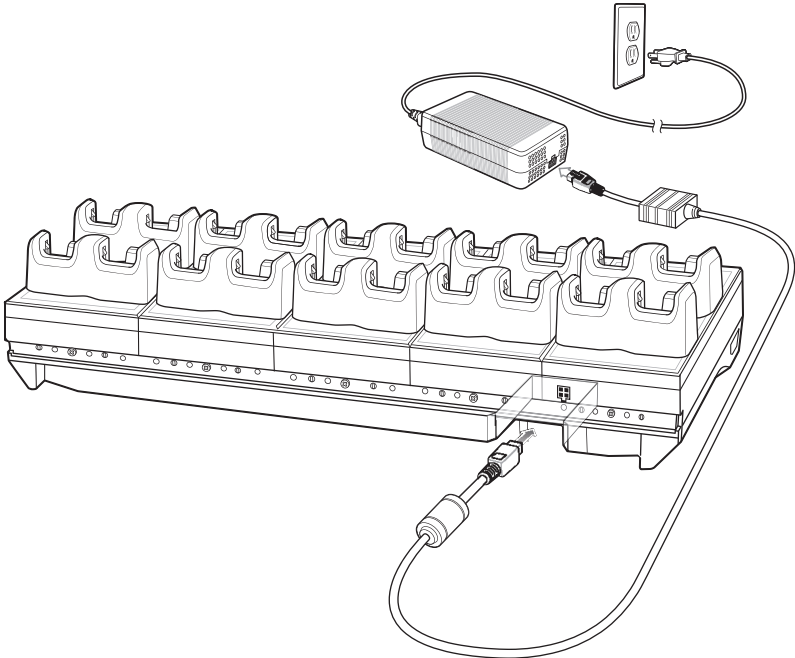

Figure 43 20-Slot RS5100 Charge Only Cradle Setup



40-Slot Battery Charger



NOTE: Ensure that you follow the guidelines for battery safety described in [Battery Safety Guidelines on page 300](#).

The 40-Slot Battery Charger charges up to forty spare batteries.

Figure 44 40-Slot Battery Charger

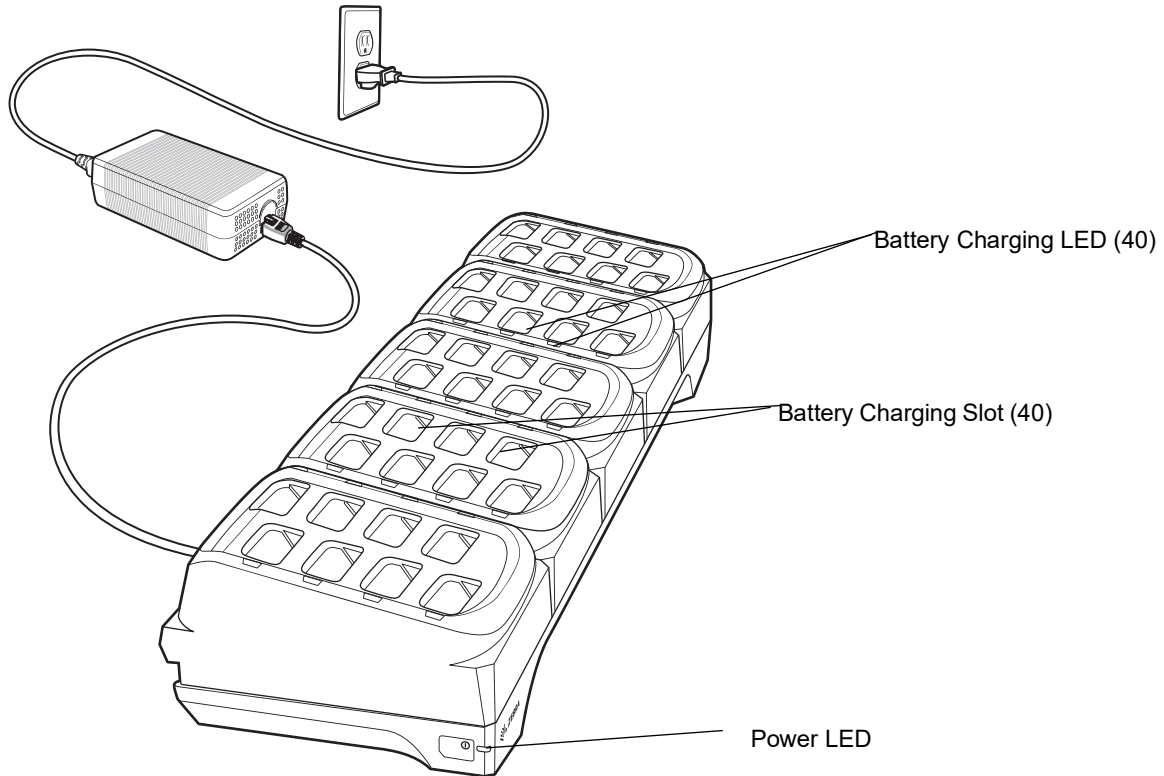
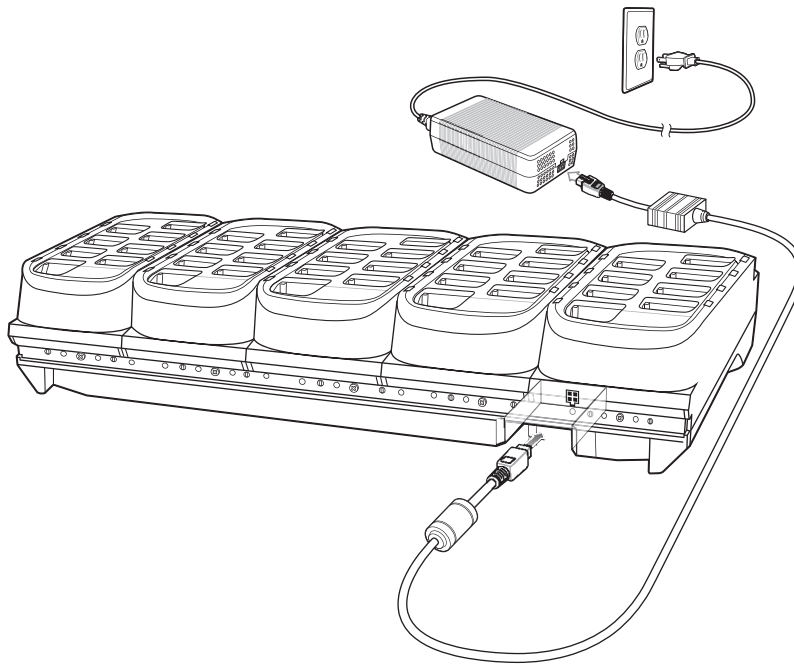

Figure 45 40-Slot Battery Charger Setup



Lanyard Mount

The lanyard mount is comprised of the lanyard trigger assembly, retractor, and lanyard. The lanyard trigger assembly allows the RS5100 to be worn around the neck or hip. It requires separate purchase of the retractor with magnetic recoil for neck or hip mounting.

Figure 46 Lanyard Mount

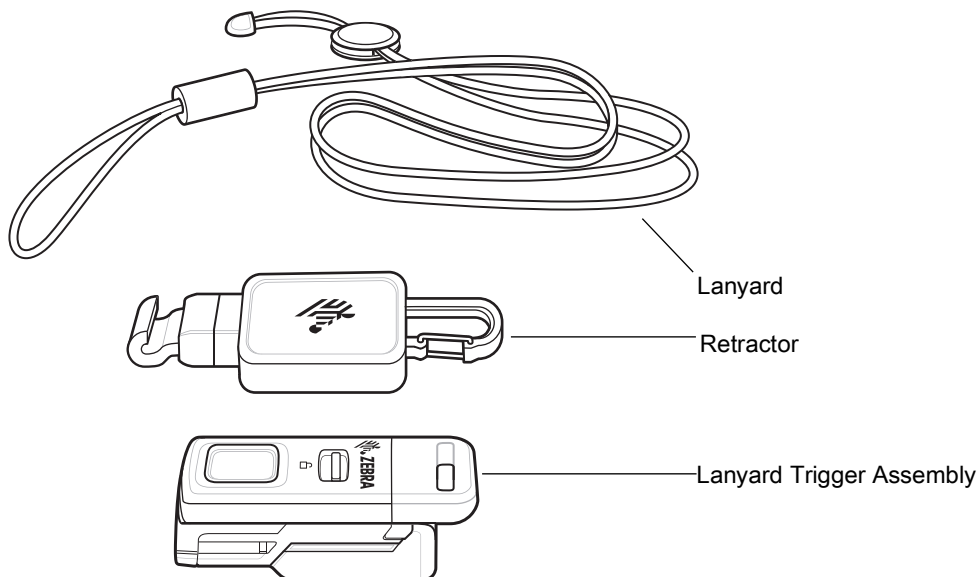

To attach the lanyard trigger assembly and retractor to the RS5100:

1. Align the contacts on the RS5100 assembly with the contacts on the back of the lanyard trigger assembly and slide the lanyard trigger assembly into the notch on the RS5100 assembly.

Figure 47 Attach Lanyard Trigger Assembly

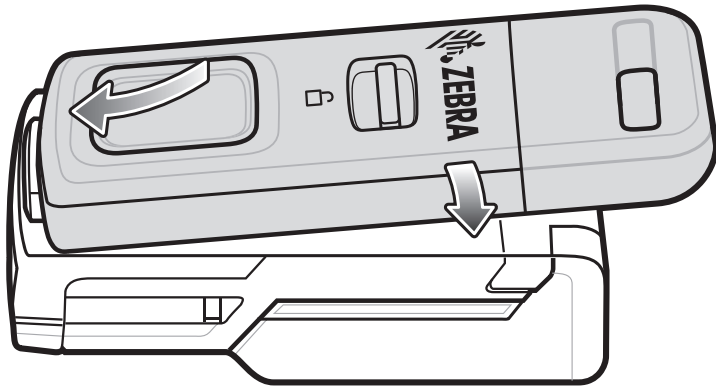

2. Push down on the lanyard trigger assembly to snap into place.
3. If using the retractor (optional), slide the hook on the bottom of the retractor into the top/front slot on the lanyard trigger assembly and push the lanyard through the clasp on the top of the retractor.

Figure 48 Attach Lanyard With Retractor

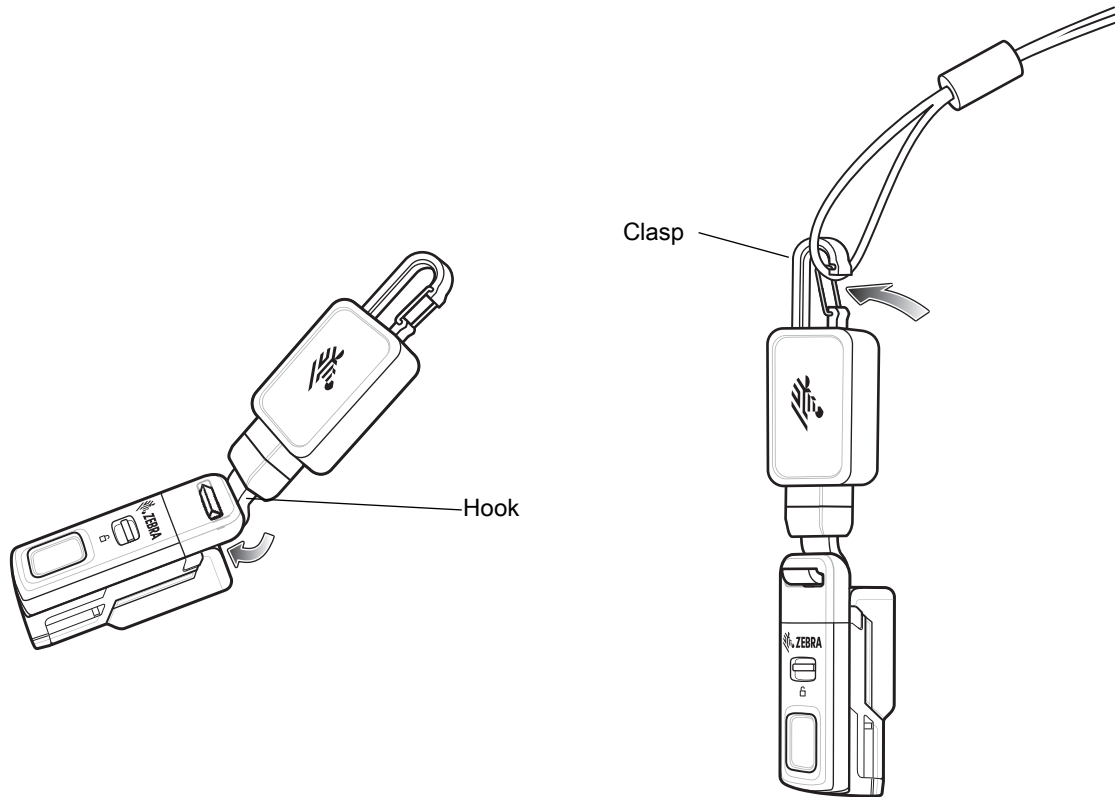

4. If you are not using the retractor, insert the lanyard through the top/front slot on the lanyard trigger assembly.

Figure 49 Attach Lanyard Without Retractor

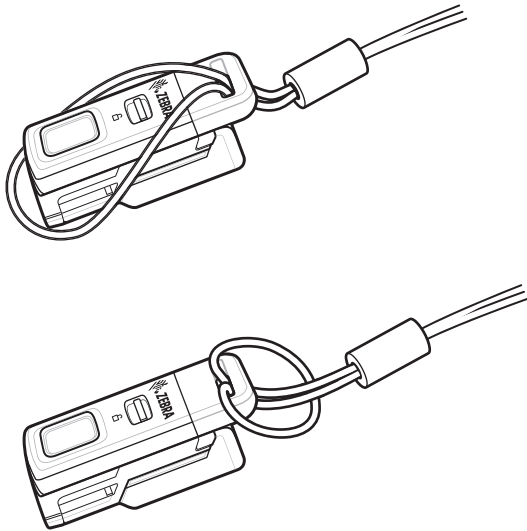

To remove the lanyard trigger assembly, slide the release latch and detach the lanyard trigger assembly from the RS5100 assembly.

Figure 50 Detach Lanyard Trigger

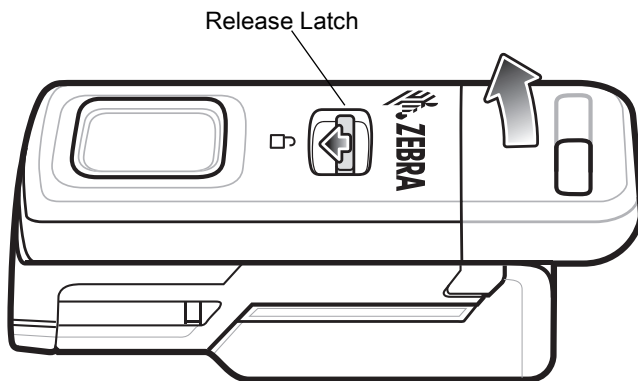

Back of Hand Mount

The Back of Hand Mount (which includes a hand strap), allows the RS5100 to be worn on the back of your hand and provides a remote finger trigger. It is one size to fit all and is ambidextrous.

To attach the back of hand mount, perform the following three steps:

1. Install the strap to the back of hand assembly (there is a difference for a right hand user and a left hand user)
2. Position the back of hand mount on the hand.
3. Install the RS5100 onto the back of hand mount.

To install the strap to the back of hand assembly for a right hand user:

1. Hold the Y shape strap in one hand and the back of hand assembly in the other hand.
2. Slide one end of the strap with the snap through the top left slot on the back of hand assembly and snap into place.

Figure 51 Right Hand User: Snap Strap Into Place

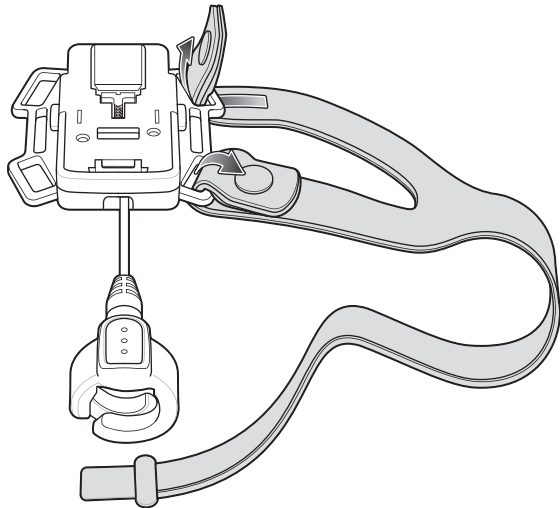

3. Slide the other end of the strap with the snap through the bottom left slot on the back of hand assembly and snap into place.
4. Slide the remaining long end of the strap with the velcro through the right center slot of the back of hand assembly and velcro in place.

Figure 52 Right Hand User: Velcro Strap Into Place

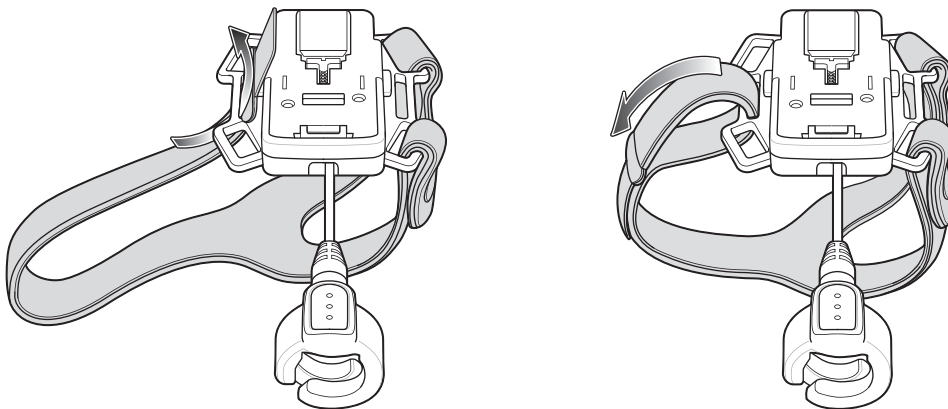

To install the strap to the back of hand assembly for a left hand user:

1. Hold the Y shape strap in one hand and the back of hand assembly in the other hand.
2. Slide one end of the strap with the snap through the top right slot on the back of hand assembly and snap into place.

Figure 53 Left Hand User: Snap Strap Into Place



3. Slide the other end of the strap with the snap through the bottom right slot on the back of hand assembly and snap into place.
4. Slide the remaining long end of the strap with the velcro through the left center slot of the back of hand assembly and velcro in place.

Figure 54 Left Hand User: Velcro Strap Into Place

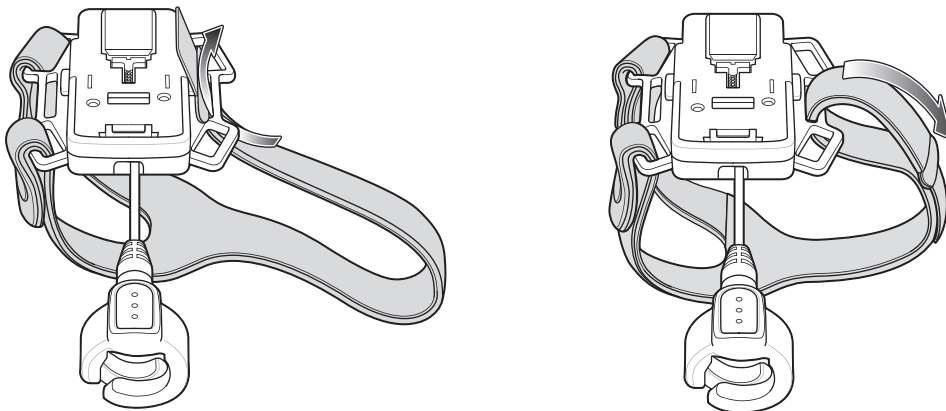

To position the back of hand mount on the hand:

1. Slide your hand through the strap, with your thumb through the smaller opening between the two snaps and your remaining four fingers through the larger opening.

Figure 55 Slide Hand Through Strap

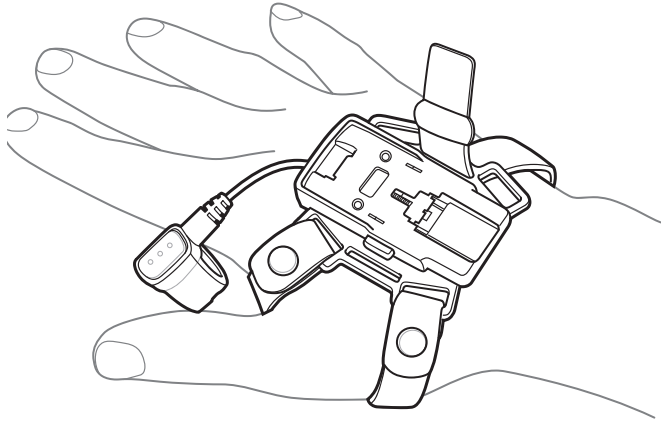

2. Adjust the velcro to a comfortable position.

Figure 56 Adjust Velcro

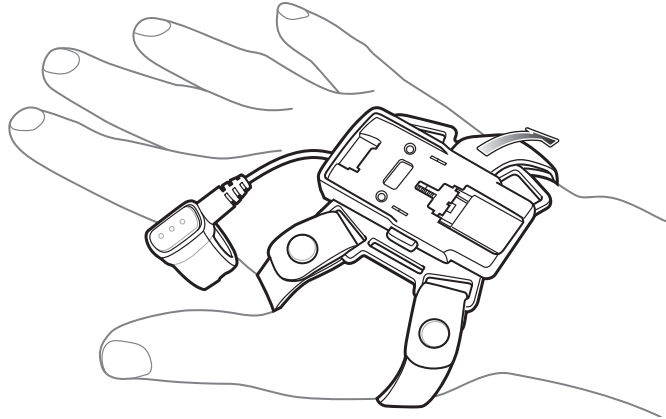

3. Pull the finger trigger to place it over your index finger and slide the finger trigger down the index finger.
4. Rotate the finger trigger so that the trigger button is easy access to your thumb.

Figure 57 Position Finger Trigger

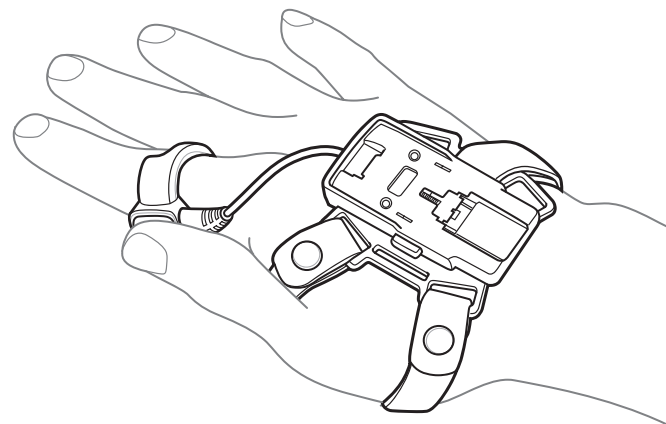

To install the RS5100 onto the back of hand mount:

1. Align the contacts on the RS5100 assembly with the contacts on the back of hand mount and engage the slot (located at the top of the RS5100 on the backside) on the RS5100 with the opening at the top of the back of hand mount.

Figure 58 Align and Engage RS5100

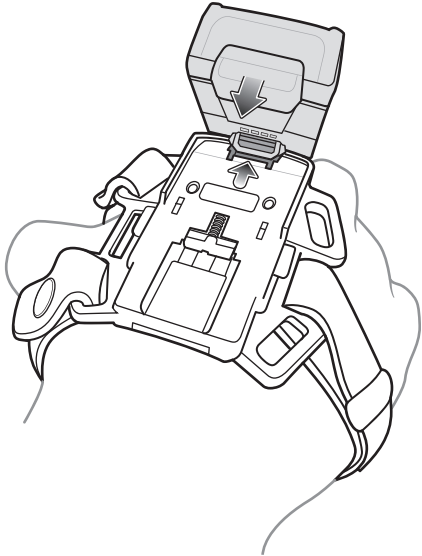

2. Push down on the RS5100 to snap into place.

Figure 59 Push Down To Snap In Place



To detach the RS5100 from the back of hand mount, press the release buttons on both sides of the back of hand mount using your thumb and middle finger, and lift the RS5100 off the back of hand mount using your index finger.

Figure 60 Detach RS5100 From Back of Hand Mount

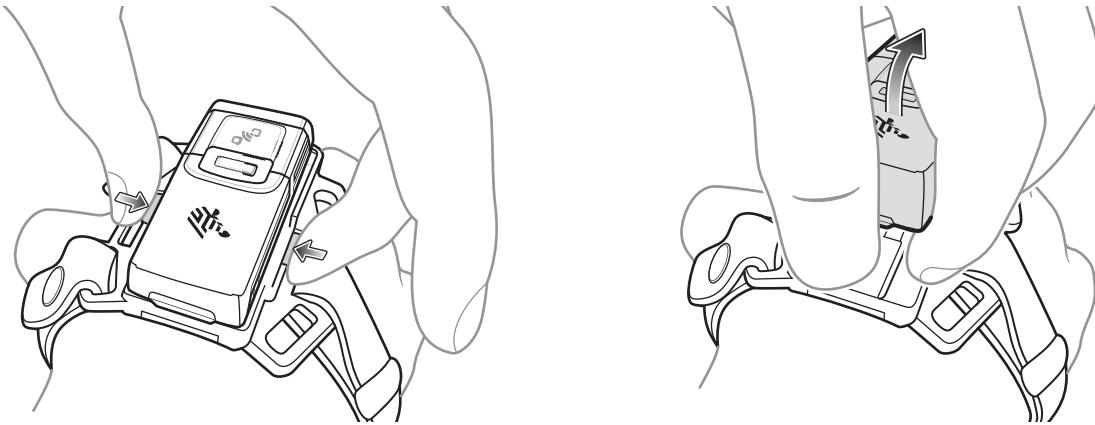

Enterprise Hand Mount

The Enterprise Hand Mount allows the RS5100 to be worn on the back of your hand and provides a remote finger trigger. It comes in multiple sizes to fit all and is available for right-handed and left-handed users. You can distinguish the size by the color of the stitching on the hand wrap.

- Small = white
- Medium = black
- Large = blue

To attach the hand mount to the hand mount assembly:

1. Install the hand wrap to the back of hand assembly, if not already installed (note the position for right hand user or left hand user).
2. Position the hand wrap on the hand.
3. Install the RS5100 onto the back of hand mount, if not already installed.

Install Hand Wrap: Right Hand User

To install the hand wrap to the back of hand assembly for a right hand user:

1. Insert the trigger cable and button through the trigger slot.

Figure 61 Insert Trigger Cable and Button

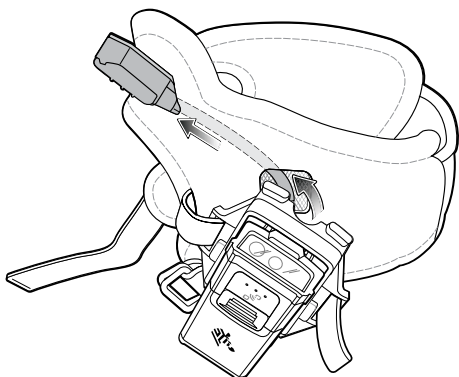

2. Insert the velcro strap through the left slot of the mount and slide under the mount.

Figure 62 Insert Velcro Strap Through Slot

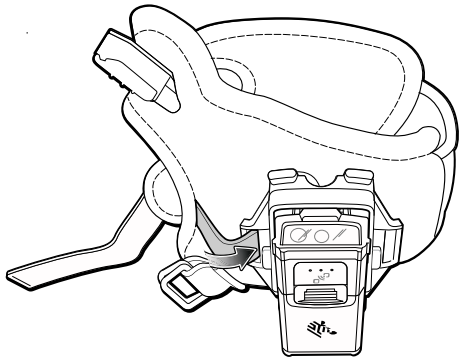

3. Insert the velcro strap through the right slot of the mount and fasten the velcro strap end.

Figure 63 Insert Velcro Strap Through Other Slot and Fasten

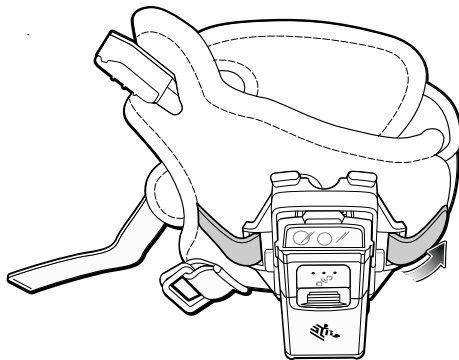

Install Hand Wrap: Left Hand User

To install the hand wrap to the back of hand assembly for a left hand user:

1. Insert the trigger cable and button through the trigger slot.

Figure 64 Insert Trigger Cable and Button

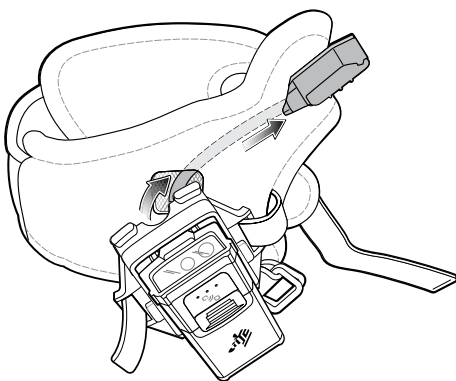

2. Insert the velcro strap through the right slot of the mount and slide under the mount.

Figure 65 Insert Velcro Strap Through Slot

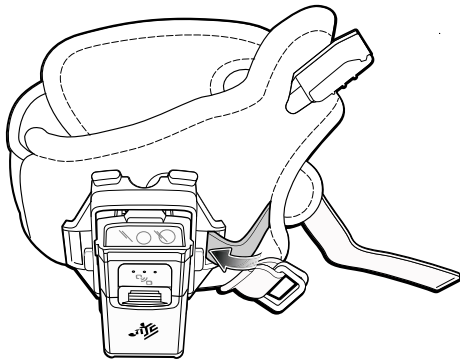

3. Insert the velcro strap through the left slot of the mount and fasten the velcro strap end.

Figure 66 Insert Velcro Strap Through Other Slot and Fasten

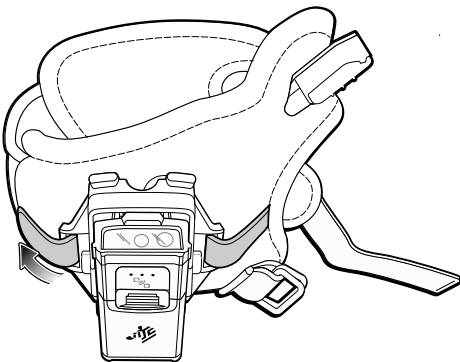

Position Hand Wrap on Hand

To position the hand wrap on the hand:

1. Slide your hand through the hand wrap, with your thumb through the smaller opening and your remaining four fingers through the larger opening. Note the position for a left-hand user and a right-hand user.

Figure 67 Slide Hand Through Hand Wrap

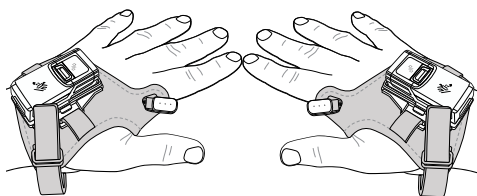

2. Adjust the strap to a comfortable position to fit securely by tightening or loosening the strap.

Figure 68 Adjust the Strap

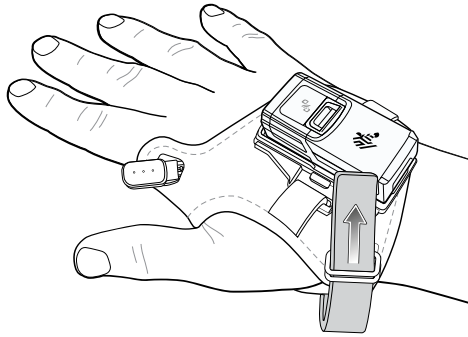

3. Slide the strap through the buckle and secure the end of the strap in place with the velcro.

Figure 69 Slide Strap Through Buckle and Secure Strap

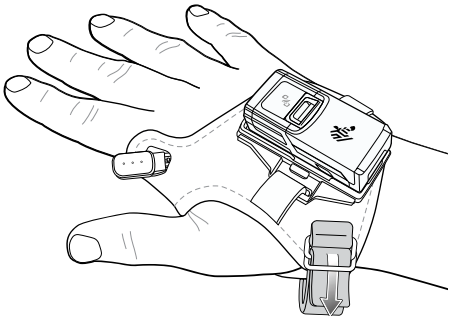

NOTE: The snap under the strap is meant as a safety breakaway and is not meant for securing the strap.

4. Position the finger trigger button to rotate it so that the button is easy access to your thumb and then fasten it in place with the velcro.

Figure 70 Position the Finger Trigger Button

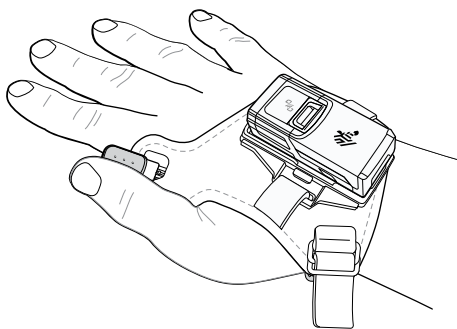

5. Align the mount on the hand wrap:

- a. Lift the velcro strap holding the mount in place.

Figure 71 Lift the Velcro Strap

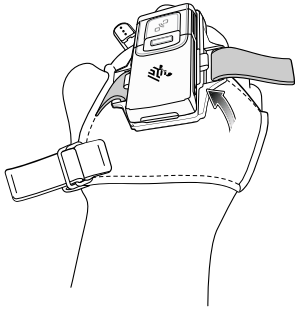

- b. Detach and lift the mount, which is holding the RS5100.
- c. Reposition the mount on the hand wrap to align the mount with your middle finger knuckle.

Figure 72 Reposition the Mount

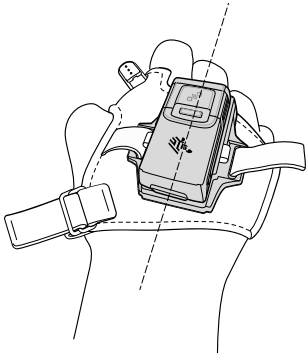

- d. Fasten the velcro strap.

Figure 73 Fasten the Velcro Strap

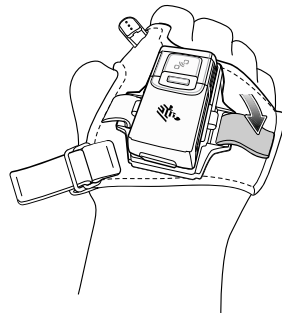

Install RS5100

To install the RS5100 onto the back of hand mount:

1. Align the contacts on the RS5100 assembly with the contacts on the back of hand mount and engage the slot (located at the top of the RS5100 on the backside) on the RS5100 with the opening at the top of the back of hand mount.

Figure 74 Align the Contacts and Engage the Slot

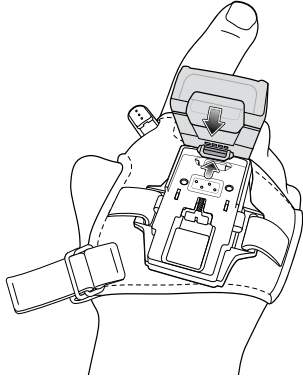

2. Push down on the RS5100 to snap into place.

Figure 75 Push Down

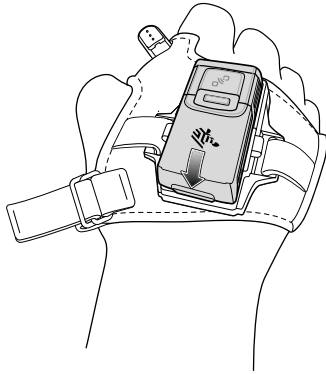

Correct Installation

Figure 76 Correct: Align Top of Device

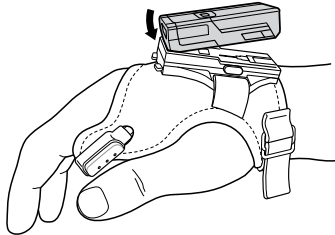
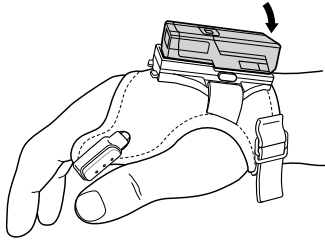

Figure 77 Correct: Push Down on Bottom of Device



Incorrect Installation

Figure 78 Incorrect: Align Bottom of Device

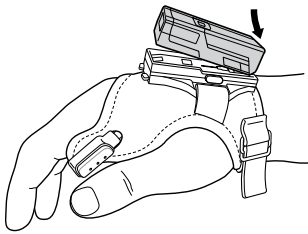
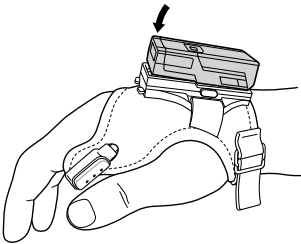

Figure 79 Incorrect: Push Down on Top of Device



Detach RS5100

To detach the RS5100 from the back of hand mount:

1. Press the release buttons on both sides of the back of hand mount using your thumb and middle finger.

Figure 80 Press Release Buttons

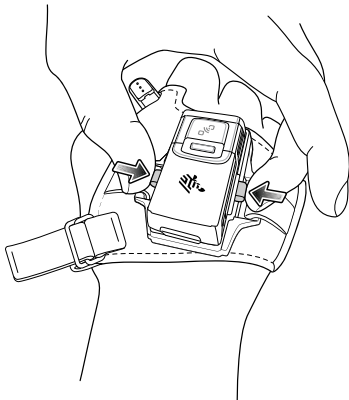

2. Lift the RS5100 off the back of hand mount using your index finger.

Figure 81 Lift the Device

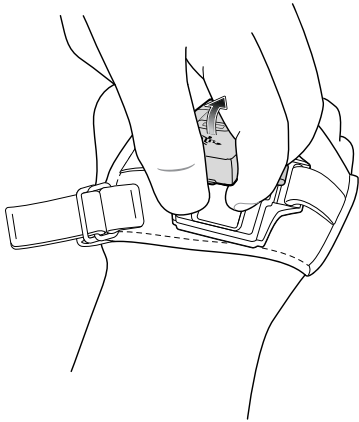

Cleaning the Hand Wrap

Before cleaning the hand wrap, remove the electronics:

1. Unfasten the strap and detach the mount holding the RS5100

Figure 82 Unfasten the Strap and Detach Mount

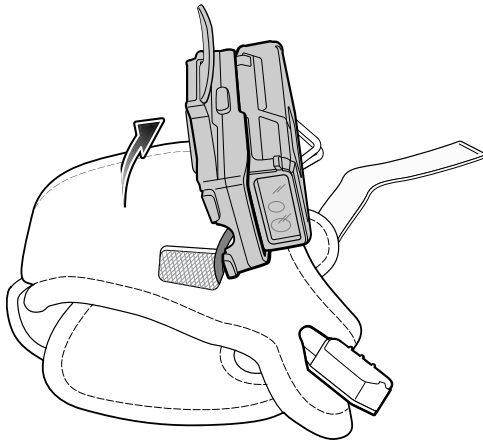

2. Slide the mount off the strap.

Figure 83 Slide Mount Off Strap

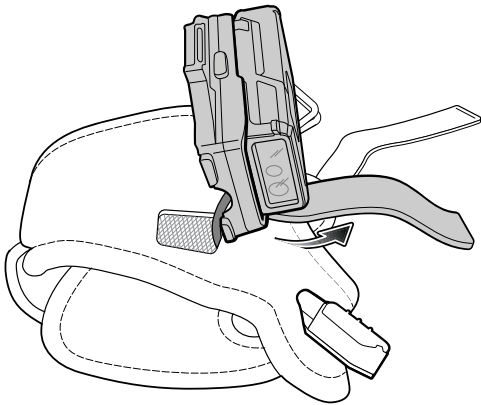

3. Remove the finger trigger button and cable from the hand wrap.

Figure 84 Remove Finger Trigger Button and Cable from Hand Wrap

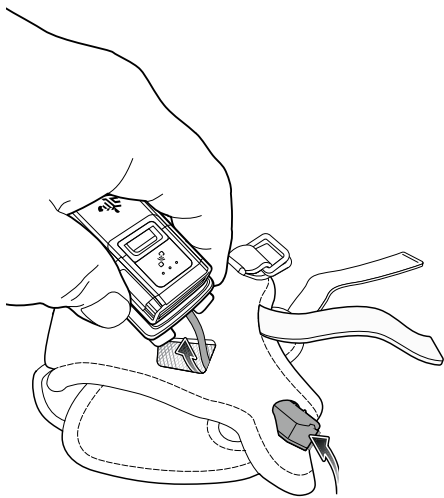

4. Use an approved cleaning agent or mild detergent on the hand wrap material only and air dry.

Bluetooth Adapter

NOTE: Refer to the Bluetooth Adapter's Product Reference Guide (p/n MN-004832-01EN) for more information including programming parameters.

The BT-RS5X6-DNGL-01 Bluetooth Adapter provides Bluetooth capability to a host computer. It is compatible with firmware version CAAEXS00-001-R07 or later.

Mounting on a horizontal surface

Place the adapter on a horizontal surface where the pairing barcode is clearly visible.

The rubber feet provide traction and prevent surface damage.

Mounting on a Vertical Surface with Screws

Mount the adapter using screws to hold it in place. Use four M5 screws at least 13 mm long.

1. Place the Bluetooth Adapter on the desired location.
2. Mark the surface through the four mounting holes to determine the location of the screw holes.
3. Pre-drill the holes to accommodate M5 screws.

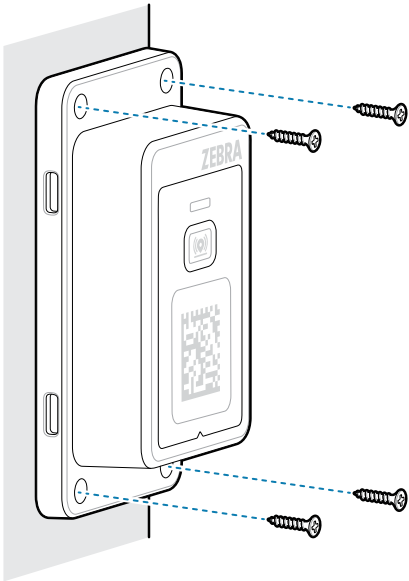

4. Attach the adapter securely to the surface.

Mounting on a Vertical Surface with Cable Ties

Use two cable ties a maximum of 8 mm wide and 3 mm thick.

NOTE: Mount the adapter no more than 2 m (6 ft 5 in.) above the floor.

1. Place the Bluetooth Adapter in the desired location.

2. Thread a cable tie through the top two mounting holes and wrap it around the pole.

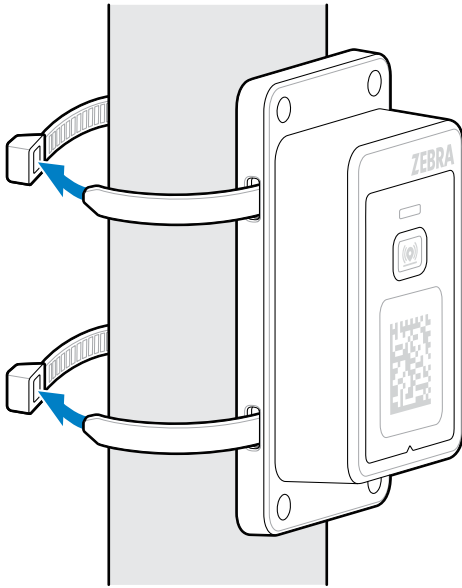

3. Tighten the cable tie.
4. Trim the excess length from the end of the cable tie.
5. Repeat the process for the bottom mounting holes.

Connecting the Adapter

Connect the Bluetooth Adapter to a host computer. Use cable CBA-U46-S07ZAR.

1. Connect the latching end of the cable to the Bluetooth Adapter port.

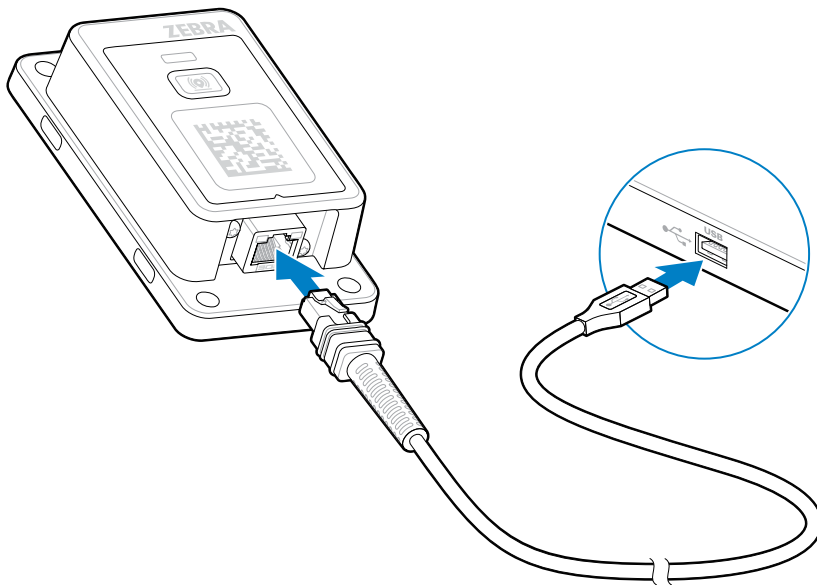

2. Press the cable firmly until you hear a click to ensure it is fully inserted into the port.
3. Connect the USB end of the cable to the host computer.

RS5100 Configuration and Update

Introduction

This chapter describes:

- Configuring the RS5100
- Debugging logger
- Upgrading Firmware.

Configuring the RS5100

Introduction

The RS5100 is provided with a default software configuration set in the factory. This software configuration can be optimized by the customer to meet their specific operational requirements. Therefore, before using the RS5100, it is essential to properly configure the RS5100 to harness its extensive capabilities and gain maximum efficiency.

Configure the RS5100 by scanning special configuration barcodes or via the 123Scan² application. When the RS5100 is connected to a Zebra mobile computer, some of the RS5100 configuration parameters can be automatically overwritten by an EMDK application or DataWedge.



NOTE: A warm boot should be performed to reset the RS5100 after scanning the configuration barcodes.

Once the RS5100 is paired to a Zebra host device, the scanning software will disable the ability to read the configuration barcodes.

DataWedge

DataWedge is an application available on Zebra mobile computers. DataWedge is used to configure scanner settings and process scanned data before sending to an application.

DataWedge is based on profiles. A profile contains information on how DataWedge should behave with different applications. Using profiles, each application can have a specific DataWedge configuration. For example, each user application can have a profile which outputs scanned data in the required format when that application comes to the foreground. DataWedge can be configured to process the same set of captured data differently based on the requirements of each application.

Once connected to a Zebra mobile computer, DataWedge settings override some of the RS5100 parameters previously set via configuration barcodes or 123Scan². These settings only apply while the RS5100 is connected to the Zebra mobile computer, and do not persist once the RS5100 has been disconnected and reset.

For more information on DataWedge, refer to WT6000 Integrator Guide, p/n MN-002699-xx.

123Scan²

123Scan² is a PC-based software tool that enables rapid customized setup of the device.

123Scan² uses a wizard tool to guide users through a streamlined set up process. Settings are saved in a configuration file that can be distributed via e-mail or used to generate a sheet of programming barcodes.

123Scan² can upgrade the device firmware, check on-line to enable support for newly released products, generate a collection of multi-setting barcodes if the number of settings is very large, and generate reports with asset tracking information.

For more information on 123Scan², go to [123Scan and Software Tools](#).

Real Time Logger

The RS5100 includes a Real Time Logger application that logs events, errors, exceptions and software diagnostics of the RS5100 during its operation. Each log record has a time stamp with a 1 ms resolution. The log record memory size is 4 MB and operates in a cyclic way. Log records reset after cold or clean boot.

[Figure 85](#) shows the Real Time Logger file content as shown on a host computer screen.

Figure 85 Real Time Logger Content Screen

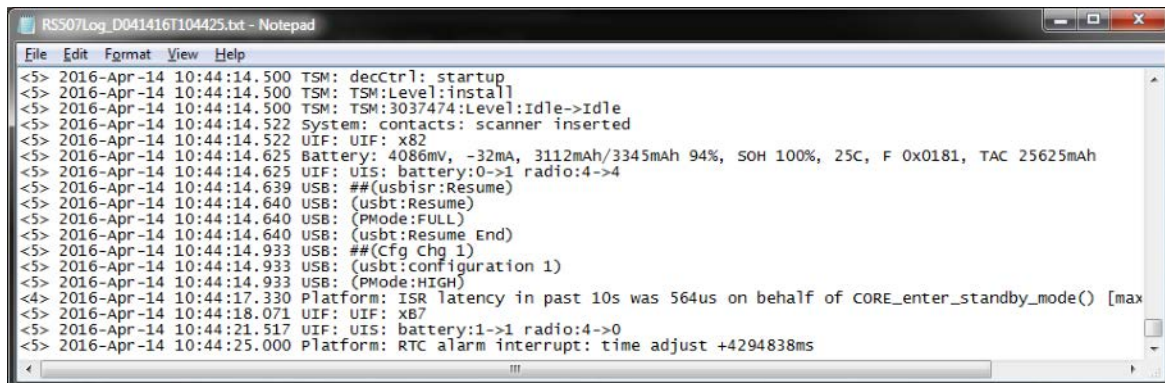

```

RS507Log_D041416T104425.txt - Notepad
File Edit Format View Help
<5> 2016-Apr-14 10:44:14.500 TSM: decCtrl: startup
<5> 2016-Apr-14 10:44:14.500 TSM: TSM:Level:install
<5> 2016-Apr-14 10:44:14.500 TSM: TSM:3037474:Level:Idle->Idle
<5> 2016-Apr-14 10:44:14.522 System: contacts: scanner inserted
<5> 2016-Apr-14 10:44:14.522 UIF: UIF: x82
<5> 2016-Apr-14 10:44:14.625 Battery: 4086mv, -32mA, 3112mAh/3345mAh 94%, SOH 100%, 25C, F 0x0181, TAC 25625mAh
<5> 2016-Apr-14 10:44:14.625 UIF: UIS: battery:0->1 radio:4->4
<5> 2016-Apr-14 10:44:14.639 USB: ##(usbisr:Resume)
<5> 2016-Apr-14 10:44:14.640 USB: (usbt:Resume)
<5> 2016-Apr-14 10:44:14.640 USB: (Pmode:FULL)
<5> 2016-Apr-14 10:44:14.640 USB: (usbt:Resume End)
<5> 2016-Apr-14 10:44:14.933 USB: ##(cfg Chg 1)
<5> 2016-Apr-14 10:44:14.933 USB: (usbt:configuration 1)
<5> 2016-Apr-14 10:44:14.933 USB: (Pmode:HIGH)
<4> 2016-Apr-14 10:44:17.330 Platform: ISR latency in past 10s was 564us on behalf of CORE_enter_standby_mode() [max
<5> 2016-Apr-14 10:44:18.071 UIF: UIF: xB7
<5> 2016-Apr-14 10:44:21.517 UIF: UIS: battery:1->1 radio:4->0
<5> 2016-Apr-14 10:44:25.000 Platform: RTC alarm interrupt: time adjust +4294838ms
  
```

Retrieving the RS5100 Log File

The RS5100 log file is retrieved using a host computer, USB trigger and the RS507PCTool application.

The RS507PCTool application requires the Scanner CDC driver be installed on the host computer. This driver creates a virtual COM port (Scanner Virtual COM Port) when the RS6000 is connected to a host computer via USB. Both RS507PCTool and the Scanner USB CDC driver are available for download from zebra.com/support.



SSI over USB CDC (non-persistent)

To obtain log messages over a USB connection:

1. Scan the **SSI over USB CDC** bar code to switch the RS5100 USB connection from SNAPI to CDC / SSI.
2. Connect the RS5100 to the host computer via the USB trigger.

3. Open the RS507PCTool application.
4. In the **Device** section, click **Open**. The virtual COM port assigned to the RS5100 opens and the **Device Info** for the RS5100 will be shown.

When the RS5100 is connected to the RS507PCTool, the logger time on the RS5100 is synchronized with the host computer's time.

Figure 86 RS507PCTool

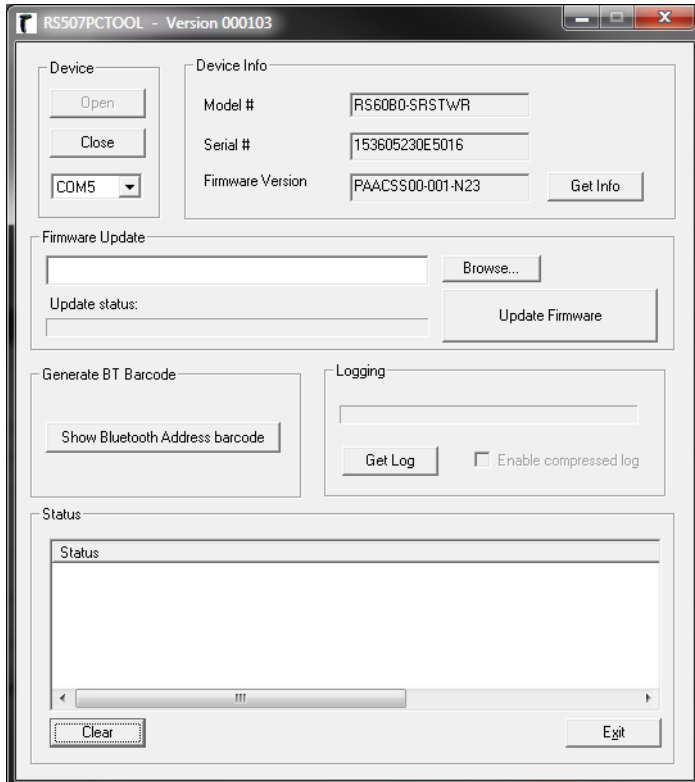

5. Click **Get Log**.
6. The log file is saved in the same directory on the host computer where RS507PCTool application is located.

Figure 87 RS507PCTool Finished Getting Log File

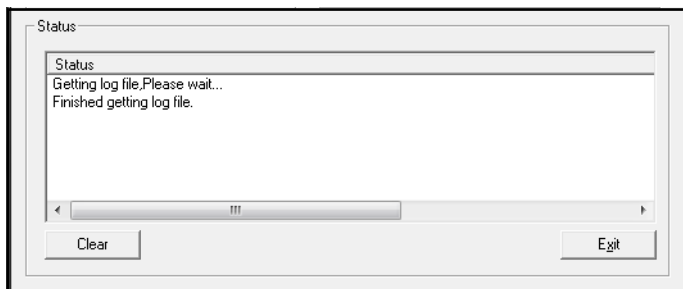

7. The log file name format is RS507Log_D<date&time>.txt

RS5100 Firmware Update

RS5100 devices can be upgraded and re-flashed with a new firmware. The update is performed by downloading the firmware to the RS5100 flash memory. If download fails, the previous firmware remains operational. The

firmware remains inside the RS5100 memory even when powering the RS5100 off/on (removing and re-installing the battery).

The RS5100 firmware can be updated using:

- Bluetooth with 123Scan²
- Bluetooth-connected Zebra device.

NOTE: Check to make sure that the current firmware version is different from the version selected for an update. If you try to update the firmware to the same version currently installed, the update process will fail.

Updating firmware with different parameters causes the scanner to reset. The connection to the host device is also reset. Manually scan to pair the scanner to a host device after a firmware update.

Bluetooth Using 123Scan²

The 123Scan² application can upgrade the RS5100 firmware using Bluetooth to connect to a host computer. For more information on using 123Scan² go to [123Scan and Software Tools](#).

Bluetooth Connected Zebra Device

The Zebra WT6000 or later device provides Enterprise Mobility Developer Kit (EMDK) support for updating the firmware of a Bluetooth connected RS5100. Using a Mobile Device Management (MDM) application, RS5100 firmware is deployed to the WT6000 device. Then an EMDK application must be created which downloads the firmware to the RS5100.

To update the RS5100 firmware by using the Zebra Device Central app (version 2.1.0.14 or later):

1. Deploy the firmware update to the Zebra host device in the location:
\\internal shared storage\Android\data\com.symbol.devicecentral\files
2. Open the Device Central app, and pair the RS5100.
3. Tap the RS5100 item to show the device details.
4. Tap the **Firmware update** button.

Miscellaneous Imager Options

Introduction

You can program the RS5100 to perform various functions, or activate different features. This chapter describes each user preference feature and provides programming barcodes for selecting these features.

The RS5100 ships with the settings shown in [Table 9 on page 120](#) (also see [Standard Default Parameters](#) for all defaults). If the default values suit requirements, programming is not necessary.

To set feature values, scan a single barcode or a short barcode sequence. The settings are stored in non-volatile memory and are preserved even when the RS5100 is powered down.



NOTE: Most computer monitors allow scanning the barcodes directly on the screen. When scanning from the screen, be sure to set the document magnification to a level where you can see the barcode clearly, and bars and/or spaces are not merging.

To return all features to default values, use [Default Parameters on page 122](#). Throughout the programming barcode menus, asterisks indicate (*) default values.



* Indicates Default — *Enable Parameter — Feature/Option
(1) — Option Value

Scanning Sequence Examples

In most cases, scanning one barcode sets the parameter value. For example, to set the beeper tone to high, scan the **High Frequency** (beeper tone) barcode listed under [Beeper Tone on page 126](#). The RS5100 issues a fast warble beep and the LED turns green, signifying a successful parameter entry.

Other parameters, such as **Data Transmission Formats**, require scanning several barcodes. See these parameter descriptions for this procedure.

Errors While Scanning

Unless otherwise specified, to correct an error during a scanning sequence, just re-scan the correct parameter.

User Preferences/Miscellaneous Options Parameter Defaults

[Table 9](#) lists defaults for user preferences parameters. To change the default values:

- Scan the appropriate barcodes in this guide. These new values replace the standard default values in memory. To recall the default parameter values, use the [Default Parameters on page 122](#).
- Configure the RS5100 using the 123Scan² configuration program (go to [123Scan2 on page 116](#)).



NOTE: Go to [Standard Default Parameters](#) for all user preferences, hosts, symbologies, and miscellaneous default parameters.

Table 9 User Preferences Parameter Defaults

Parameter	Parameter Number ¹	SSI Number ²	Default	Page Number
User Preferences				
Set Default Parameter			Restore Defaults	122
Parameter Barcode Scanning	236	ECh	Enable	123
Beep After Good Decode	56	38h	Enable	124
Beep on Insertion	288		Enabled	124
Beeper Volume	140	8Ch	High	125
Beeper Tone	145	91h	High	126
Beeper Duration	628	F1h 74h	Short	127
Suppress Power Up Beeps	721	F1h D1h	Do Not Suppress	127
Low Battery Indication	779	F2h 08h	Enable	128
Hand-Held Trigger Mode	138	8Ah	Level	129

1. Parameter number decimal values are used for programming via RSM commands.

2. SSI number hex values are used for programming via SSI commands.

Table 9 User Preferences Parameter Defaults (Continued)

Parameter	Parameter Number ¹	SSI Number ²	Default	Page Number
Hand-Held Decode Aiming Pattern	306	F0h 32h	Enable	130
Picklist Mode	402	F0h 92h	Disabled Always	131
Continuous Barcode Read	649	F1h 89h	Disable	132
Unique Barcode Reporting	723	F1h D3h	Enable	133
Decode Session Timeout	136	88h	9.9 Sec	134
Timeout Between Decodes, Same Symbol	137	89h	0.5 Sec	135
Timeout Between Decodes, Different Symbols	144	90h	0.1 sec	136
Fuzzy 1D Processing	514	F1h 02h	Enable	136
Decode Mirror Images (Data Matrix Only)	537	F1h 19h	Auto	137
Mobile Phone/Display Mode	716	F1h CCh	Normal	138
PDF Prioritization	719	F1h CFh	Disable	139
PDF Prioritization Timeout	720	F1h D0h	200 ms	139
Decoding Illumination	298	F0h 2Ah	Enable	141
Motion Tolerance	858	F2h 5Ah	Less Motion Tolerance	142
Miscellaneous Options				
Add an Enter Key	N/A	N/A	N/A	142
Transmit Code ID Character	45	2Dh	None	142
Prefix Value	99, 105	63h, 69h	7013 <CR><LF>	143
Suffix 1 Value	98, 104	62h, 68h	7013 <CR><LF>	143
Suffix 2 Value	100, 106	64h, 6Ah		
Scan Data Transmission Format	235	EBh	Data as is	144
FN1 Substitution Values	103, 109	67h, 6Dh	7013 <CR><LF>	146
Transmit "No Read" Message	94	5E	Disable	147
Trigger Buttons Enabled	2068	F8h 08h 14h	Enable	147
Low Power Mode	128	80h	Enable	150

1. Parameter number decimal values are used for programming via RSM commands.

2. SSI number hex values are used for programming via SSI commands.

User Preferences

Default Parameters

The RS5100 can be reset to two types of defaults: factory defaults or custom defaults. Scan the appropriate barcode below to reset the RS5100 to its default settings and/or set the RS5100 current settings as the custom default.

- **Restore Defaults** - Resets all default parameters as follows:
 - If custom default values were configured (see **Write to Custom Defaults**), the custom default values are set for all parameters each time the **Restore Defaults** barcode below is scanned.
 - If no custom default values were configured, the factory default values are set for all parameters each time the **Restore Defaults** barcode below is scanned. (For factory default values, see [Standard Default Parameters.](#))
- **Set Factory Defaults** - Scan the **Set Factory Defaults** barcode below to eliminate all custom default values and set the RS5100 to factory default values (For factory default values, see [Standard Default Parameters](#)).
- **Write to Custom Defaults** - Custom default parameters can be configured to set unique default values for all parameters. After changing all parameters to the desired default values, scan the **Write to Custom Defaults** barcode below to configure custom defaults.



*Restore Defaults



Set Factory Defaults



Write to Custom Defaults

Parameter Barcode Scanning

Parameter # 236 (SSI # ECh)

To disable the decoding of parameter barcodes, including the **Set Defaults** parameter barcodes, scan the **Disable Parameter Scanning** barcode below. To enable decoding of parameter barcodes, scan **Enable Parameter Scanning**.



***Enable Parameter Barcode Scanning**
(1)



Disable Parameter Barcode Scanning
(0)

Beep After Good Decode

Parameter # 56 (SSI # 38h)

Scan a barcode below to select whether or not the RS5100 beeps after a good decode. If selecting **Do Not Beep After Good Decode**, the beeper still operates during parameter menu scanning and to indicate error conditions.



***Beep After Good Decode (Enable)**
(1)



Do Not Beep After Good Decode (Disable)
(0)

Beep on Insertion

Parameter # 288

When the RS5100 is inserted into a cradle and detects power, it emits a short low beep. This feature is enabled by default.

To enable or disable beeping on insertion, scan the appropriate barcode below.



***Enable Beep on Insertion**
(00h)



Disable Beep on Insertion
(01h)

Beeper Volume

Parameter # 140 (SSI # 8Ch)

To select a beeper volume, scan the **Low Volume**, **Medium Volume**, or **High Volume** barcode.



Low Volume
(2)



Medium Volume
(1)



***High Volume**
(0)

Beeper Tone

Parameter # 145 (SSI # 91h)

To select a beeper tone, scan one of the following barcodes.



Off
(3)



Low Tone
(2)

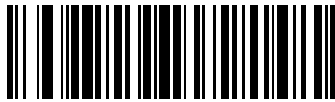

Medium Tone
(1)

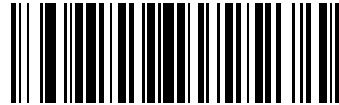

* High Tone
(0)

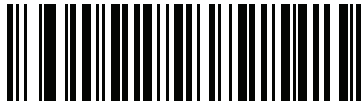

Medium to High Tone (2-tone)
(4)

Beeper Duration

Parameter # 628 (SSI # F1h 74h)

To select the duration for the beeper, scan one of the following barcodes.



*** Short
(0)**

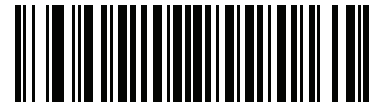

**Medium
(1)**

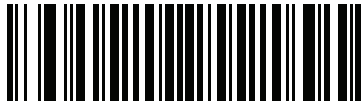

**Long
(2)**

Suppress Power Up Beeps

Parameter # 721 (SSI # F1h D1h)

Scan a barcode below to select whether or not to suppress the RS5100 power-up beeps.



***Do Not Suppress Power Up Beeps
(0)**



**Suppress Power Up Beeps
(1)**

Low Battery Indication

Parameter # 779 (SSI # F2h 0Bh)

Scan a barcode below to select whether or not to suppress the RS5100's low battery indication.



Disable
(0)



***Enable**
(1)

Hand-Held Trigger Mode

Parameter # 138 (SSI # 8Ah)

Select one of the following trigger modes for the RS5100.

- **Standard (Level)** - A trigger pull activates decode processing. Decode processing continues until the barcode decodes, you release the trigger, or the [Decode Session Timeout on page 134](#) occurs.
- **Two Stage:**
 - **Option 1** - This trigger mode presents the laser aiming guide when you press and hold the trigger. Releasing the trigger activates decode processing.
 - **Option 2** - This trigger mode projects the laser aiming guide on the first trigger press. A second trigger press within a short period of time activates decode processing.



NOTE: Hand-held Trigger Mode is not supported for triggerless models and should be left at its default value.

When configured for Bluetooth SSI mode, the triggering mode is controlled by the Zebra Mobile Computer and this setting should be left at its default value.

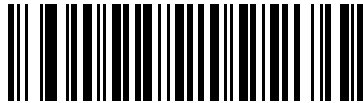

*Level (Standard)
(0)



Two Stage - Option 1
(14)



Two Stage - Option 2
(15)

Hand-Held Decode Aiming Pattern

Parameter # 306 (SSI # F0h 32h)

Select **Enable Hand-Held Decode Aiming Pattern** to project the aiming dot during barcode capture, **Disable Hand-Held Decode Aiming Pattern** to turn the aiming dot off, or **Enable Hand-Held Decode Aiming Pattern on PDF** to project the aiming dot when the RS5100 detects a 2D barcode.



NOTE: With [Picklist Mode on page 131](#) enabled, the decode aiming dot flashes even when the **Hand-Held Decode Aiming Pattern** is disabled.

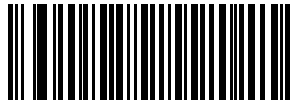

***Enable Hand-Held Decode Aiming Pattern
(2)**



**Disable Hand-Held Decode Aiming Pattern
(0)**

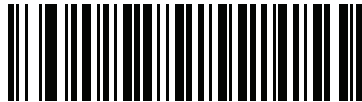

**Enable Hand-Held Decode Aiming Pattern on PDF
(3)**

Picklist Mode

Parameter # 402 (SSI # F0h 92h)

Picklist mode enables the RS5100 to decode only barcodes that are aligned under the LED aiming dot. Select one of the following picklist modes for the RS5100:

- **Disabled Always** - Picklist mode is always disabled.
- **Enabled in Hand-Held Mode** - Picklist mode is enabled in hand-held mode.



***Disabled Always**
(0)

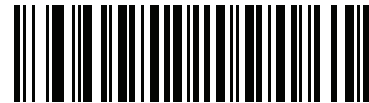

Enabled in Hand-Held Mode
(1)

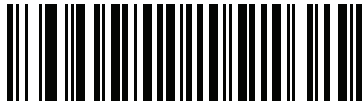

Enabled Always
(2)



NOTE: Picklist Mode temporarily overrides the Disable Decode Aiming Pattern parameter. You can not disable the decode aiming pattern when Picklist Mode is enabled.

Continuous Barcode Read

Parameter # 649 (SSI # F1h 89h)

Enable this to report every barcode while the trigger is pulled.



NOTE: Zebra strongly recommends enabling [Picklist Mode on page 131](#) with this feature. Disabling Picklist Mode can cause accidental decodes when more than one barcode is in the RS5100's field of view.

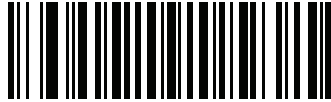

***Disable Continuous Barcode Read
(0)**



**Enable Continuous Barcode Read
(1)**

Unique Barcode Reporting

Parameter # 723 (SSI # F1h D3h)

Enable this to report only unique barcodes while the trigger is pulled. This option only applies when **Continuous Barcode Read** is enabled.



Disable Continuous Barcode Read Uniqueness
(0)



***Enable Continuous Barcode Read Uniqueness**
(1)

Decode Session Timeout

Parameter # 136 (SSI # 88h)

This parameter sets the maximum time decode processing continues during a scan attempt. It is programmable in 0.1 second increments from 0.5 to 9.9 seconds. The default timeout is 9.9 seconds.

To set a Decode Session Timeout, scan the barcode below. Next, scan two numeric barcodes from [Alphanumeric and Numeric Barcodes](#) that correspond to the desired on time. Enter a leading zero for single digit numbers. For example, to set a Decode Session Timeout of 0.5 seconds, scan the barcode below, then scan the **0** and **5** barcodes. To correct an error or change the selection, scan [Cancel on page 334](#).



Decode Session Timeout

Timeout Between Decodes, Same Symbol

Parameter # 137 (SSI # 89h)

Use this option in Continuous Barcode Read mode to prevent the beeper from continuously beeping when a barcode is left in the RS5100 field of view. The barcode must be out of the field of view for the timeout period before the RS5100 reads the same consecutive barcode. It is programmable in 0.1 second increments from 0.0 to 9.9 seconds. The default interval is 0.5 seconds.

To select the timeout between decodes for the same barcode, scan the barcode below, then scan two numeric barcodes from [Alphanumeric and Numeric Barcodes](#) that correspond to the desired interval, in 0.1 second increments.



Timeout Between Decodes, Same Symbol

Timeout Between Decodes, Different Symbol

Parameter # 144 (SSI # 90h)

Use this option in presentation mode or Continuous Barcode Read to control the time the RS5100 is inactive between decoding different barcodes. It is programmable in 0.1 second increments from 0.1 to 9.9 seconds. The default is 0.1 seconds.

To select the timeout between decodes for different barcodes, scan the barcode below, then scan two numeric barcodes from [Alphanumeric and Numeric Barcodes](#) that correspond to the desired interval, in 0.1 second increments.



NOTE: Timeout Between Decodes, Different Symbols cannot be greater than or equal to the Decode Session Timeout.

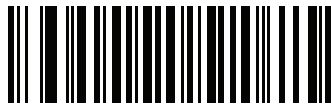

Timeout Between Decodes, Different Symbols

Fuzzy 1D Processing

Parameter # 514 (SSI # F1h 02h)

This option is enabled by default to optimize decode performance on 1D barcodes, including damaged and poor quality barcodes. Disable this only if you experience time delays when decoding 2D barcodes, or in detecting a no decode.



*Enable Fuzzy 1D Processing
(1)



Disable Fuzzy 1D Processing
(0)

Decode Mirror Images (Data Matrix Only)

Parameter # 537 (SSI # F1h 19h)

Select an option for decoding mirror image Data Matrix barcodes:

- Always - decode only Data Matrix barcodes that are mirror images
- Never - do not decode Data Matrix barcodes that are mirror images
- Auto - decode both mirrored and un-mirrored Data Matrix barcodes.



Never
(0)



Always
(1)



*** Auto**
(2)

Mobile Phone/Display Mode

Parameter # 716 (SSI # F1h CCh)

This mode improves barcode reading performance off mobile phones and electronic displays. Select Enhanced in hand-held or select Normal Mobile Phone/Display Mode.



***Normal Mobile Phone/Display Mode
(0)**



**Enhanced in Hand-Held Mode
(1)**

PDF Prioritization

Parameter # 719 (SSI # F1h CFh)

Enable this feature to delay decoding a 1D barcode (Code 128) by the value specified in [PDF Prioritization Timeout](#). During that time the RS5100 attempts to decode a PDF417 symbol (e.g., on a US driver's license), and if successful, reports this only. If it does not decode (can not find) a PDF417 symbol, it reports the 1D symbol after the timeout. The 1D symbol must be in the device's field of view for the RS5100 to report it. This parameter does not affect decoding other symbologies..

**NOTE:**

The 1D Code 128 barcode lengths include the following:

- 7 to 10 characters
- 14 to 17 characters
- 27 to 28 characters

In addition, a Code 39 barcode with the following lengths are considered to potentially be part of a US driver's license:

- 8 characters
- 12 characters



***Disable PDF Prioritization
(0)**

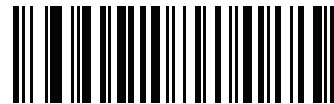

**Enable PDF Prioritization
(1)**

PDF Prioritization Timeout

Parameter # 720 (SSI # F1h D0h)

When [PDF Prioritization](#) is enabled, this timeout specifies how long the RS5100 attempts to decode a PDF417 symbol before reporting the 1D barcode in the field of view.

Scan the following barcode, then scan four digits from [Alphanumeric and Numeric Barcodes](#) that specify the timeout in milliseconds. For example, to enter 400 ms, scan the following barcode, then scan 0400. The range is 0 to 5000 ms, and the default is 200 ms.



PDF Prioritization Timeout

Decoding Illumination

Parameter # 298 (SSI # F0h 2Ah)

Selecting **Enable Decoding Illumination** causes the RS5100 to flash illumination to aid decoding. Select **Disable Decoding Illumination** to prevent the RS5100 from using decoding illumination.

Enabling illumination usually results in superior barcode reading performance. The effectiveness of the illumination decreases as the distance to the target increases.



***Enable Decoding Illumination
(1)**



**Disable Decoding Illumination
(0)**

Motion Tolerance

Parameter # 858 (SSI # F2h 5Ah)

Less Motion Tolerance provides optimal decoding performance on 1D barcodes.

To increase motion tolerance and speed decoding when scanning a series of 1D barcodes in rapid progression, scan **More Motion Tolerance**.



***Less Motion Tolerance
(0)**

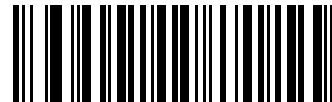

**More Motion Tolerance
(1)**

Miscellaneous Scanner Parameters

Add an Enter Key

To add an Enter key (carriage return/line feed) after scanned data, scan the following barcode.

To program other prefixes and/or suffixes, see [Prefix/Suffix Values on page 143](#).

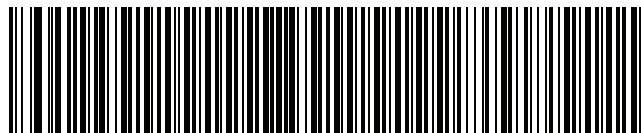

Add Enter Key (Carriage Return/Line Feed)

Transmit Code ID Character

Parameter # 45 (SSI # 2Dh)

A Code ID character identifies the code type of a scanned barcode. This is useful when decoding more than one code type. In addition to any single character prefix already selected, the Code ID character is inserted between the prefix and the decoded symbol.

Select no Code ID character, a Symbol Code ID character, or an AIM Code ID character. For Code ID characters, see [Programming Reference on page 327](#).



NOTE: If you enable Symbol Code ID Character or AIM Code ID Character, and enable [Transmit “No Read” Message on page 147](#), the RS5100 appends the code ID for Code 39 to the NR message.

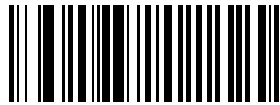

Symbol Code ID Character
(2)



AIM Code ID Character
(1)

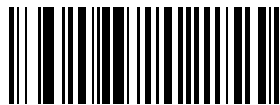

*None
(0)

Prefix/Suffix Values

Key Category Parameter # P = 99, S1 = 98, S2 = 100 (SSI # P = 63h, S1 = 62h, S2 = 64h)

Decimal Value Parameter # P = 105, S1 = 104, S2 = 106 (SSI # P = 69h, S1 = 68h, S2 = 6Ah)

You can append a prefix and/or one or two suffixes to scan data for use in data editing. To set a value for a prefix or suffix, scan a four-digit number (i.e., four barcodes from [Alphanumeric and Numeric Barcodes](#)) that corresponds to that value. See [ASCII Character Sets](#) for the four-digit codes.

When using host commands to set the prefix or suffix, set the key category parameter to 1, then set the 3-digit decimal value. See [ASCII Character Sets](#) for the four-digit codes.

The default prefix and suffix value is 7013 <CR><LF> (the Enter key). To correct an error or change a selection, scan [Cancel on page 334](#).



NOTE: To use Prefix/Suffix values, first set the [Scan Data Transmission Format on page 144](#).

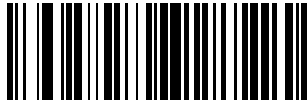

**Scan Prefix
(7)**

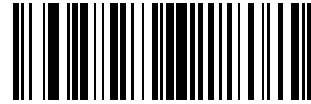

**Scan Suffix 1
(6)**



**Scan Suffix 2
(8)**

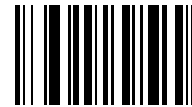

Data Format Cancel

Scan Data Transmission Format

Parameter # 235 (SSI # EBh)

To change the scan data format, scan one of the following eight barcodes corresponding to the desired format.



NOTE: If using this parameter do not use ADF rules to set the prefix/suffix.

To set values for the prefix and/or suffix, see [Prefix/Suffix Values on page 143](#).



***Data As Is**
(0)



<DATA> <SUFFIX 1>
(1)



<DATA> <SUFFIX 2>
(2)



<DATA> <SUFFIX 1> <SUFFIX 2>
(3)



<PREFIX> <DATA >
(4)

Scan Data Transmission Format (continued)



<PREFIX> <DATA> <SUFFIX 1>
(5)



<PREFIX> <DATA> <SUFFIX 2>
(6)



<PREFIX> <DATA> <SUFFIX 1> <SUFFIX 2>
(7)

FN1 Substitution Values

Key Category Parameter # 103 (SSI # 67h)

Decimal Value Parameter # 109 (SSI # 6Dh)

The wedge and USB HID keyboard hosts support a FN1 Substitution feature. Enabling this substitutes any FN1 character (0x1b) in an EAN128 barcode with a value. This value defaults to 7013 (Enter Key).

When using host commands to set the FN1 substitution value, set the key category parameter to 1, then set the 3-digit keystroke value. See the ASCII Character Set table for the current host interface for the desired value.

To select a FN1 substitution value via barcode menus:

1. Scan the barcode below.



Set FN1 Substitution Value

2. Locate the keystroke desired for FN1 Substitution in the ASCII Character Set table for the current host interface. Enter the 4-digit ASCII Value by scanning each digit in [Alphanumeric and Numeric Barcodes](#).

To correct an error or change the selection, scan **Cancel**.

To enable FN1 substitution for USB HID keyboard, scan the **Enable FN1 Substitution** barcode on page 38.

Transmit “No Read” Message

Parameter # 94 (SSI # 5Eh)

Scan a barcode below to select whether or not to transmit a No Read message. Enable this to transmit the characters NR when a successful decode does not occur before trigger release or the **Decode Session Timeout** expires. See [Decode Session Timeout on page 134](#). Disable this to send nothing to the host if a symbol does not decode.



NOTE: If you enable **Transmit No Read**, and also enable Symbol Code ID Character or AIM Code ID Character for [Transmit Code ID Character on page 142](#), the RS5100 appends the code ID for Code 39 to the NR message.



**Enable No Read
(1)**



***Disable No Read
(0)**

Trigger Buttons Enabled

Parameter # 2068 (SSI# F8h 08h 14h)

The trigger buttons on RS5100 can be enabled or disabled using the following barcodes. Please make sure to use the correct barcode appropriate for the type of trigger module mounted on the RS5100. In case of a misconfiguration, doing a clean boot will restore the default state of triggers.

RS5100 with single trigger module

The default value enables the top trigger and the single trigger – whether it's rotated to be left trigger or rotated to be the right trigger.



*** Top Trigger and Single Trigger Enabled**

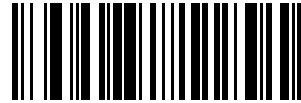

Single Trigger Only Enabled



Top Trigger Only Enabled

RS5100 with double trigger module

The default value enables all the triggers available - the top trigger, the left trigger and the right trigger.

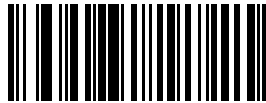

*** Top Trigger, Left Trigger, and Right Trigger Enabled**

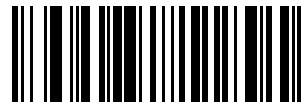

Left Trigger Only



Right Trigger Only

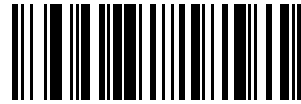

Top Trigger Only

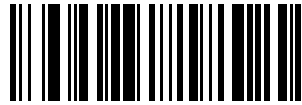

Left Trigger and Right Trigger

RS5100 with Lanyard or Back-Of-Hand mount.

The default value enables the Lanyard/Back-of-Hand mount trigger, but disables the top trigger.

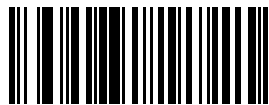

*** Lanyard/Back of Hand Mount Trigger Enabled**

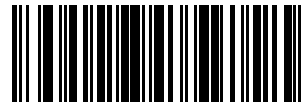

**Top Trigger and Lanyard/Back of Hand Mount
Trigger Enabled**

Low Power Mode

Parameter # 128

This parameter controls low power mode after a decode attempt.

This applies to serial and keyboard wedge connections. If disabled, power remains on after each decode attempt. If you enable this parameter, use the Time Delay to Low Power Mode parameter to set the inactivity time period.



*Enable Low Power Mode (1)

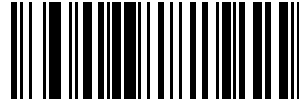

Disable Low Power Mode (0)

Symbologies

Introduction

This chapter describes symbology features and provides programming barcodes for selecting these features. To set feature values, scan a single barcode or a short barcode sequence. The settings are stored in non-volatile memory and are preserved even when the RS5100 powers down.



NOTE: Most computer monitors allow scanning the barcodes directly on the screen. When scanning from the screen, be sure to set the document magnification to a level where you can see the barcode clearly, and bars and/or spaces do not merge.

Select a host type (see each host chapter for specific host information) after the power-up beeps sound. This is only necessary upon the first power-up when connected to a new host.

To return all features to default values, see [Default Parameters on page 122](#). Throughout the programming barcode menus, asterisks (*) indicate default values.

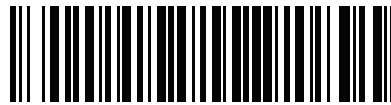

* Indicates Default *Enable Parameter Feature/Option
(1) Option Value

Scanning Sequence Examples

In most cases, scanning one barcode sets the parameter value. For example, to transmit barcode data without the UPC-A check digit, simply scan the **Do Not Transmit UPC-A Check Digit** barcode under [Transmit UPC-A Check Digit on page 167](#). The RS5100 issues a fast warble beep and the LED turns green, signifying a successful parameter entry.

Other parameters, such as **Set Length(s) for D 2 of 5** require scanning several barcodes. See the individual parameter, such as **Set Length(s) for D 2 of 5**, for this procedure.

Errors While Scanning

Unless otherwise specified, to correct an error during a scanning sequence, just re-scan the correct parameter.

Symbology Parameter Defaults

Table 10 lists the defaults for all symbology parameters. To change the default values, scan the appropriate barcodes in this guide. These new values replace the standard default values in memory. To recall the default parameter values, see [Default Parameters on page 122](#).



NOTE: See [Standard Default Parameters](#) for all user preferences, hosts, and miscellaneous default parameters.

Table 10 Symbology Parameter Defaults

Parameter	Parameter Number	SSI Number	Default	Page Number
Enable/Disable All Code Types				158
1D Symbologies				
UPC/EAN				
UPC-A	1	01h	Enable	159
UPC-E	2	02h	Enable	159
UPC-E1	12	0Ch	Disable	160
EAN-8/JAN 8	4	04h	Enable	160
EAN-13/JAN 13	3	03h	Enable	161
Bookland EAN	83	53h	Disable	161
Decode UPC/EAN/JAN Supplementals (2 and 5 digits)	16	10h	Ignore	163
User-Programmable Supplementals			000	165
Supplemental 1:	579	F1h 43h		
Supplemental 2:	580	F1h 44h		
UPC/EAN/JAN Supplemental Redundancy	80	50h	10	165
Decode UPC/EAN/JAN Supplemental AIM ID	672	F1h A0h	Combined	166
UPC Reduced Quiet Zone	1289	F8h 05h 09h	Disable	167
Transmit UPC-A Check Digit	40	28h	Enable	167
Transmit UPC-E Check Digit	41	29h	Enable	168
Transmit UPC-E1 Check Digit	42	2Ah	Enable	168
UPC-A Preamble	34	22h	System Character	169
UPC-E Preamble	35	23h	System Character	170
UPC-E1 Preamble	36	24h	System Character	171
Convert UPC-E to A	37	25h	Disable	172

Table 10 Symbology Parameter Defaults (Continued)

Parameter	Parameter Number	SSI Number	Default	Page Number
Convert UPC-E1 to A	38	26h	Disable	172
EAN-8/JAN-8 Extend	39	27h	Disable	173
Bookland ISBN Format	576	F1h 40h	ISBN-10	174
UCC Coupon Extended Code	85	55h	Disable	175
Coupon Report	730	F1h DAh	New Coupon Format	176
ISSN EAN	617	F1h 69h	Disable	177
Code 128				
Code 128	8	08h	Enable	178
Set Length(s) for Code 128	209, 210	D1h, D2h	1 to 55	179
GS1-128 (formerly UCC/EAN-128)	14	0Eh	Enable	181
ISBT 128	84	54h	Enable	181
ISBT Concatenation	577	F1h 41h	Autodiscriminate	182
Check ISBT Table	578	F1h 42h	Enable	183
ISBT Concatenation Redundancy	223	DFh	10	183
Code 128 Security Level	751	F1h EFh	Security Level 1	184
Code 128 Reduced Quiet Zone	1208	F8h 04h B8h	Disable	185
Ignore Code 128 <FNC4>	1254	F8h 04h E6h	Disable	185
Code 128 Exclusive	Param 673	SSI F1h A1H	Disable	186
Code 39				
Code 39	0	00h	Enable	187
Trioptic Code 39	13	0Dh	Disable	187
Convert Code 39 to Code 32 (Italian Pharmacy Code)	86	56h	Disable	188
Code 32 Prefix	231	E7h	Disable	189
Set Length(s) for Code 39	18, 19	12h, 13h	1 to 55	190
Code 39 Check Digit Verification	48	30h	Disable	191
Transmit Code 39 Check Digit	43	2Bh	Disable	191
Code 39 Full ASCII Conversion	17	11h	Disable	192
Code 39 Security Level	750	F1h EEh	Security Level 1	193
Code 39 Reduced Quiet Zone	1209	F8h 04h B9h	Disable	194
Code 39 Buffering - Scan and Store	113	71h	Disable	194

Table 10 Symbology Parameter Defaults (Continued)

Parameter	Parameter Number	SSI Number	Default	Page Number
Code 93				
Code 93	9	09h	Enable	197
Set Length(s) for Code 93	26, 27	1Ah, 1Bh	1 to 55	197
Code 11				
Code 11	10	0Ah	Disable	199
Set Lengths for Code 11	28, 29	1Ch, 1Dh	4 to 55	199
Code 11 Check Digit Verification	52	34h	Disable	201
Transmit Code 11 Check Digit(s)	47	2Fh	Disable	202
Interleaved 2 of 5 (ITF)				
Interleaved 2 of 5 (ITF)	6	06h	Disable	203
Set Lengths for I 2 of 5	22, 23	16h, 17h	6 to 55	204
I 2 of 5 Check Digit Verification	49	31h	Disable	206
Transmit I 2 of 5 Check Digit	44	2Ch	Disable	207
Convert I 2 of 5 to EAN 13	82	52h	Disable	207
I 2 of 5 Security Level	1121	F8h 04h 61h	Security Level 1	208
I 2 of 5 Reduced Quiet Zone	1210	F8h 04h BAh	Disable	209
Discrete 2 of 5 (DTF)				
Discrete 2 of 5	5	05h	Disable	210
Set Length(s) for D 2 of 5	20, 21	14h 15h	1 to 55	211
Codabar (NW - 7)				
Codabar	7	07h	Enable	213
Set Lengths for Codabar	24, 25	18h, 19h	4 to 55	213
CLSI Editing	54	36h	Disable	215
NOTIS Editing	55	37h	Disable	215
Codabar Upper or Lower Case Start/ Stop Characters Detection	855	F2h 57h	Upper Case	216
Codabar Mod 16 Check Digit Verification	1784	F8h 06h F8h	Disable	216
MSI				
MSI	11	0Bh	Disable	217
Set Length(s) for MSI	30, 31	1Eh, 1Fh	4 to 55	217
MSI Check Digits	50	32h	One	219

Table 10 Symbology Parameter Defaults (Continued)

Parameter	Parameter Number	SSI Number	Default	Page Number
Transmit MSI Check Digit	46	2Eh	Disable	219
MSI Check Digit Algorithm	51	33h	Mod 10/Mod 10	221
Chinese 2 of 5				
Chinese 2 of 5	408	F0h 98h	Disable	222
Matrix 2 of 5				
Matrix 2 of 5	618	F1h 6Ah	Disable	223
Matrix 2 of 5 Lengths	619 620	F1h 6Bh F1h 6Ch	4 to 55	223
Matrix 2 of 5 Check Digit	622	F1h 6Eh	Disable	225
Transmit Matrix 2 of 5 Check Digit	623	F1h 6Fh	Disable	225
Korean 3 of 5				
Korean 3 of 5	581	F1h 45h	Disable	226
Inverse 1D	586	F1h 4Ah	Regular	227
GS1 DataBar				
GS1 DataBar-14	338	F0h 52h	Enable	228
GS1 DataBar Limited	339	F0h 53h	Enable	228
GS1 DataBar Expanded	340	F0h 54h	Enable	229
Convert GS1 DataBar to UPC/EAN	397	F0h 8Dh	Disable	229
GS1 DataBar Limited Security Level	728	F1h D8h	Level 3	230
Composite				
Composite CC-C	341	F0h 55h	Disable	231
Composite CC-A/B	342	F0h 56h	Disable	231
Composite TLC-39	371	F0h 73h	Disable	232
UPC Composite Mode	344	F0h 58h	UPC Never Linked	233
Composite Beep Mode	398	F0h 8Eh	Beep As Each Code Type is Decoded	234
GS1-128 Emulation Mode for UCC/EAN Composite Codes	427	F0h ABh	Disable	234
2D Symbologies				
PDF417	15	0Fh	Enable	235
MicroPDF417	227	E3h	Disable	235
Code 128 Emulation	123	7Bh	Disable	236

Table 10 Symbology Parameter Defaults (Continued)

Parameter	Parameter Number	SSI Number	Default	Page Number
Data Matrix	292	F0h 24h	Enable	237
GS1 Data Matrix	1336	F8h 05h 38h	Disable	237
Data Matrix Inverse	588	F1h 4Ch	Inverse Autodetect	238
Maxicode	294	F0h 26h	Disable	238
QR Code	293	F0h 25h	Enable	239
GS1 QR	1343	F8h 05h 3Fh	Disable	239
MicroQR	573	F1h 3Dh	Enable	240
Aztec	574	F1h 3Eh	Enable	240
Aztec Inverse	589	F1h 4Dh	Inverse Autodetect	240
Han Xin	1167	F8h 04h 8Fh	Disable	241
Han Xin Inverse	1168	F8h 04h 90h	Regular	241
DotCode	1906	F8 07 72h	Disable	243
DotCode Inverse	1907	F8 07 73h	Autodetect	244
DotCode Mirrored	1908	F8 07 74h	Autodetect	245
DotCode Prioritize	1937	F8 07 91h	Disable	246
Postal Codes				
US Postnet	89	59h	Disable	247
US Planet	90	5Ah	Disable	247
Transmit US Postal Check Digit	95	5Fh	Enable	248
UK Postal	91	5Bh	Disable	248
Transmit UK Postal Check Digit	96	60h	Enable	249
Japan Postal	290	F0h 22h	Disable	249
Australia Post	291	F0h 23h	Disable	250
Australia Post Format	718	F1h CEh	Autodiscriminate	251
Netherlands KIX Code	326	F0h 46h	Disable	252
USPS 4CB/One Code/Intelligent Mail	592	F1h 50h	Disable	252
UPU FICS Postal	611	F1h 63h	Disable	253
Mailmark	1337	F8h 05h 39h	Disable	253
Canada Post	92	5Ch	Disable	254
Posti LAPA 4-State Code	2031	F8 07EF	Disable	254

Table 10 Symbology Parameter Defaults (Continued)

Parameter	Parameter Number	SSI Number	Default	Page Number
Symbology-Specific Security Levels				
Redundancy Level	78	4Eh	1	255
Security Level	77	4Dh	1	257
1D Quiet Zone Level	1288	F8h 05h 08h	1	258
Intercharacter Gap Size	381	F0h 7Dh	Normal	259
Report Version				259
Macro PDF				
Flush Macro PDF Buffer	N/A	N/A	N/A	260
Abort Macro PDF Entry	N/A	N/A	N/A	260

Enable/Disable All Code Types

To disable all symbologies, scan **Disable All Code Types** below. This is useful when enabling only a few code types.

Scan **Enable All Code Types** turn on (enable) all code types. This is useful when you want to read all codes, or when you want to disable only a few code types.

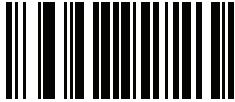

Disable All Code Types



Enable All Code Types

UPC/EAN

Enable/Disable UPC-A

Parameter # 1 (SSI # 01h)

To enable or disable UPC-A, scan the appropriate barcode below.

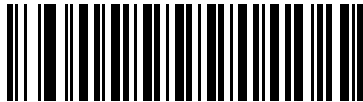

***Enable UPC-A
(1)**

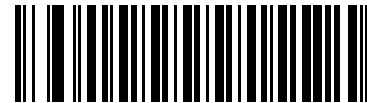

**Disable UPC-A
(0)**

Enable/Disable UPC-E

Parameter # 2 (SSI # 02h)

To enable or disable UPC-E, scan the appropriate barcode below.



***Enable UPC-E
(1)**



**Disable UPC-E
(0)**

Enable/Disable UPC-E1

Parameter # 12 (SSI # 0Ch)

UPC-E1 is disabled by default.

To enable or disable UPC-E1, scan the appropriate barcode below.



NOTE: UPC-E1 is not a UCC (Uniform Code Council) approved symbology.

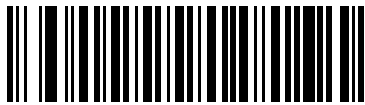

**Enable UPC-E1
(1)**

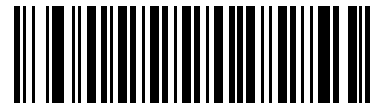

***Disable UPC-E1
(0)**

Enable/Disable EAN-8/JAN-8

Parameter # 4 (SSI # 04h)

To enable or disable EAN-8/JAN-8, scan the appropriate barcode below.



***Enable EAN-8/JAN-8
(1)**



**Disable EAN-8/JAN-8
(0)**

Enable/Disable EAN-13/JAN-13

Parameter # 3 (SSI # 03h)

To enable or disable EAN-13/JAN-13, scan the appropriate barcode below.

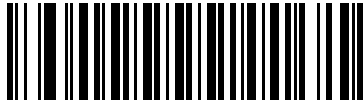

***Enable EAN-13/JAN-13
(1)**



**Disable EAN-13/JAN-13
(0)**

Enable/Disable Bookland EAN

Parameter # 83 (SSI # 53h)

To enable or disable Bookland EAN, scan the appropriate barcode below.

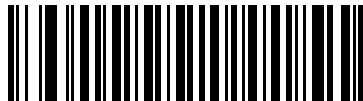

**Enable Bookland EAN
(1)**

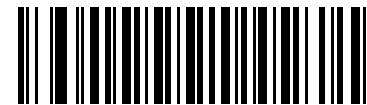

***Disable Bookland EAN
(0)**



NOTE: If you enable Bookland EAN, select a [Bookland ISBN Format on page 174](#). Also select either Decode UPC/EAN Supplementals, Autodiscriminate UPC/EAN Supplementals, or Enable 978/979 Supplemental Mode in [Decode UPC/EAN/JAN Supplementals on page 162](#).

Decode UPC/EAN/JAN Supplementals

Parameter # 16 (SSI # 10h)

Supplementals are barcodes appended according to specific format conventions (e.g., UPC A+2, UPC E+2, EAN 13+2). The following options are available:

- If you select **Ignore UPC/EAN with Supplementals**, and the RS5100 is presented with a UPC/EAN plus supplemental symbol, the RS5100 decodes UPC/EAN and ignores the supplemental characters.
- If you select **Decode UPC/EAN with Supplementals**, the RS5100 only decodes UPC/EAN symbols with supplemental characters, and ignores symbols without supplementals.
- If you select **Autodiscriminate UPC/EAN Supplementals**, the RS5100 decodes UPC/EAN symbols with supplemental characters immediately. If the symbol does not have a supplemental, the RS5100 must decode the barcode the number of times set via [UPC/EAN/JAN Supplemental Redundancy on page 165](#) before transmitting its data to confirm that there is no supplemental.
- If you select one of the following **Supplemental Mode** options, the RS5100 immediately transmits EAN-13 barcodes starting with that prefix that have supplemental characters. If the symbol does not have a supplemental, the RS5100 must decode the barcode the number of times set via [UPC/EAN/JAN Supplemental Redundancy on page 165](#) before transmitting its data to confirm that there is no supplemental. The RS5100 transmits UPC/EAN barcodes that do not have that prefix immediately.
 - Enable 378/379 Supplemental Mode
 - Enable 978/979 Supplemental Mode



NOTE: If you select 978/979 Supplemental Mode and are scanning Bookland EAN barcodes, see [Enable/Disable Bookland EAN on page 161](#) to enable Bookland EAN, and select a format using [Bookland ISBN Format on page 174](#).

- Enable 977 Supplemental Mode
- Enable 414/419/434/439 Supplemental Mode
- Enable 491 Supplemental Mode
- **Enable Smart Supplemental Mode** - applies to EAN-13 barcodes starting with any prefix listed previously.
- **Supplemental User-Programmable Type 1** - applies to EAN-13 barcodes starting with a 3-digit user-defined prefix. Set this 3-digit prefix using [User-Programmable Supplementals on page 165](#).
- **Supplemental User-Programmable Type 1 and 2** - applies to EAN-13 barcodes starting with either of two 3-digit user-defined prefixes. Set the 3-digit prefixes using [User-Programmable Supplementals on page 165](#).
- **Smart Supplemental Plus User-Programmable 1** - applies to EAN-13 barcodes starting with any prefix listed previously or the user-defined prefix set using [User-Programmable Supplementals on page 165](#).
- **Smart Supplemental Plus User-Programmable 1 and 2** - applies to EAN-13 barcodes starting with any prefix listed previously or one of the two user-defined prefixes set using [User-Programmable Supplementals on page 165](#)



NOTE: To minimize the risk of invalid data transmission, select either to decode or ignore supplemental characters.

Decode UPC/EAN/JAN Supplementals (continued)



**Decode UPC/EAN/JAN Only With Supplementals
(1)**

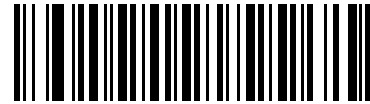

***Ignore Supplementals
(0)**

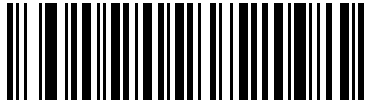

**Autodiscriminate UPC/EAN/JAN Supplementals
(2)**



**Enable 378/379 Supplemental Mode
(4)**



**Enable 978/979 Supplemental Mode
(5)**



**Enable 977 Supplemental Mode
(7)**

Decode UPC/EAN/JAN Supplementals (continued)



**Enable 414/419/434/439 Supplemental Mode
(6)**



**Enable 491 Supplemental Mode
(8)**



**Enable Smart Supplemental Mode
(3)**



**Supplemental User-Programmable Type 1
(9)**



**Supplemental User-Programmable Type 1 and 2
(10)**



**Smart Supplemental Plus User-Programmable 1
(11)**



**Smart Supplemental Plus User-Programmable 1
and 2
(12)**

User-Programmable Supplementals

Supplemental 1: Parameter # 579 (SSI # F1h 43h)

Supplemental 2: Parameter # 580 (SSI # F1h 44h)

If you selected a Supplemental User-Programmable option from [Decode UPC/EAN/JAN Supplementals on page 162](#), select **User-Programmable Supplemental 1** to set the 3-digit prefix. Then select the 3 digits using the numeric barcodes beginning on page 333. Select **User-Programmable Supplemental 2** to set a second 3-digit prefix. Then select the 3 digits using the numeric barcodes beginning on page 333. The default is 000 (zeroes).



User-Programmable Supplemental 1



User-Programmable Supplemental 2

UPC/EAN/JAN Supplemental Redundancy

Parameter # 80 (SSI # 50h)

If you selected **Autodiscriminate UPC/EAN/JAN Supplementals**, this option adjusts the number of times to decode a symbol without supplementals before transmission. The range is from two to thirty times. Five or above is recommended when decoding a mix of UPC/EAN/JAN symbols with and without supplementals. The default is 10.

Scan the barcode below to set a decode redundancy value. Next, scan two numeric barcodes in [Alphanumeric and Numeric Barcodes](#). Enter a leading zero for single digit numbers. To correct an error or change a selection, scan [Cancel](#) on page 334.

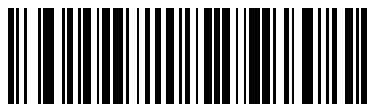

UPC/EAN/JAN Supplemental Redundancy

UPC/EAN/JAN Supplemental AIM ID Format

Parameter # 672 (SSI # F1h A0h)

Select an output format when reporting UPC/EAN/JAN barcodes with Supplementals with [Transmit Code ID Character](#) on page 142 set to **AIM Code ID Character**:

- **Separate** - transmit UPC/EAN with supplementals with separate AIM IDs but one transmission, i.e.:
]E<0 or 4><data>]E<1 or 2>[supplemental data]
- **Combined** – transmit UPC/EAN with supplementals with one AIM ID and one transmission, i.e.:
]E3<data+supplemental data>
- **Separate Transmissions** - transmit UPC/EAN with supplementals with separate AIM IDs and separate transmissions, i.e.:

]E<0 or 4><data>
]E<1 or 2>[supplemental data]



Separate
(0)



*Combined
(1)



Separate Transmissions
(2)

UPC Reduced Quiet Zone

Parameter # 1289 (SSI # F8h 05h 09h)

Scan one of the following barcodes to enable or disable decoding UPC barcodes with reduced quiet zones. If you select **Enable**, select a [1D Quiet Zone Level on page 258](#).

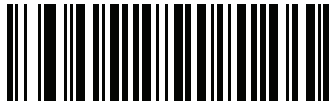

**Enable UPC Reduced Quiet Zone
(1)**

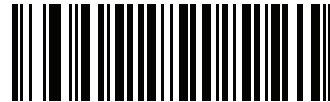

***Disable UPC Reduced Quiet Zone
(0)**

Transmit UPC-A Check Digit

Parameter # 40 (SSI # 28h)

The check digit is the last character of the symbol used to verify the integrity of the data. Scan the appropriate barcode below to transmit the barcode data with or without the UPC-A check digit. It is always verified to guarantee the integrity of the data.

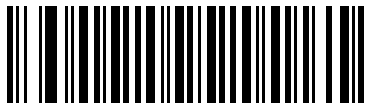

***Transmit UPC-A Check Digit
(1)**



**Do Not Transmit UPC-A Check Digit
(0)**

Transmit UPC-E Check Digit

Parameter # 41 (SSI # 29h)

The check digit is the last character of the symbol used to verify the integrity of the data. Scan the appropriate barcode below to transmit the barcode data with or without the UPC-E check digit. It is always verified to guarantee the integrity of the data.

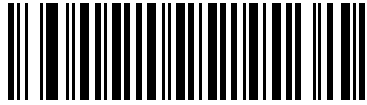

***Transmit UPC-E Check Digit
(1)**

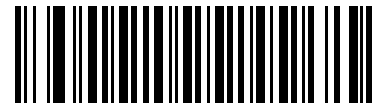

**Do Not Transmit UPC-E Check Digit
(0)**

Transmit UPC-E1 Check Digit

Parameter # 42 (SSI # 2Ah)

The check digit is the last character of the symbol used to verify the integrity of the data. Scan the appropriate barcode below to transmit the barcode data with or without the UPC-E1 check digit. It is always verified to guarantee the integrity of the data.

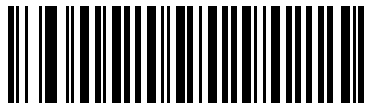

***Transmit UPC-E1 Check Digit
(1)**



**Do Not Transmit UPC-E1 Check Digit
(0)**

UPC-A Preamble

Parameter # 34 (SSI # 22h)

Preamble characters are part of the UPC symbol, and include Country Code and System Character. There are three options for transmitting a UPC-A preamble to the host device: transmit System Character only, transmit System Character and Country Code ("0" for USA), and transmit no preamble. Select the appropriate option to match the host system.

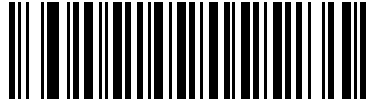

No Preamble (<DATA>
(0)

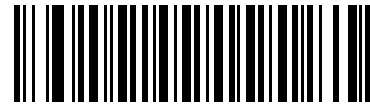

*System Character (<SYSTEM CHARACTER>
<DATA>
(1)

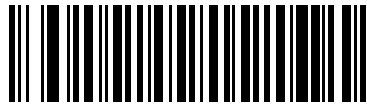

System Character & Country Code
(< COUNTRY CODE> <SYSTEM CHARACTER>
<DATA>
(2)

UPC-E Preamble

Parameter # 35 (SSI # 23h)

Preamble characters are part of the UPC symbol, and include Country Code and System Character. There are three options for transmitting a UPC-E preamble to the host device: transmit System Character only, transmit System Character and Country Code ("0" for USA), and transmit no preamble. Select the appropriate option to match the host system.

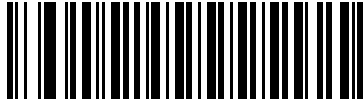

No Preamble (<DATA>
(0)

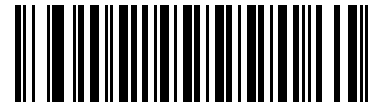

*System Character (<SYSTEM CHARACTER>
<DATA>
(1)

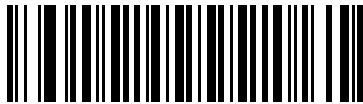

System Character & Country Code
(< COUNTRY CODE> <SYSTEM CHARACTER>
<DATA>
(2)

UPC-E1 Preamble

Parameter # 36 (SSI # 24h)

Preamble characters are part of the UPC symbol, and include Country Code and System Character. There are three options for transmitting a UPC-E1 preamble to the host device: transmit System Character only, transmit System Character and Country Code ("0" for USA), and transmit no preamble. Select the appropriate option to match the host system.

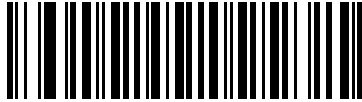

No Preamble (<DATA>)
(0)



*System Character (<SYSTEM CHARACTER> <DATA>)
(1)

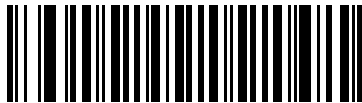

System Character & Country Code
(< COUNTRY CODE> <SYSTEM CHARACTER> <DATA>)
(2)

Convert UPC-E to UPC-A

Parameter # 37 (SSI # 25h)

Enable this to convert UPC-E (zero suppressed) decoded data to UPC-A format before transmission. After conversion, the data follows UPC-A format and is affected by UPC-A programming selections (e.g., Preamble, Check Digit).

Disable this to transmit UPC-E decoded data as UPC-E data, without conversion.

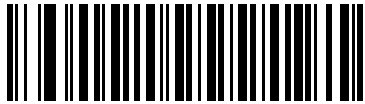

Convert UPC-E to UPC-A (Enable)
(1)

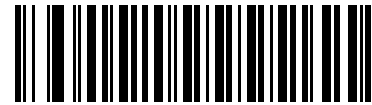

*Do Not Convert UPC-E to UPC-A (Disable)
(0)

Convert UPC-E1 to UPC-A

Parameter # 38 (SSI # 26h)

Enable this to convert UPC-E1 decoded data to UPC-A format before transmission. After conversion, the data follows UPC-A format and is affected by UPC-A programming selections (e.g., Preamble, Check Digit).

Disable this to transmit UPC-E1 decoded data as UPC-E1 data, without conversion.

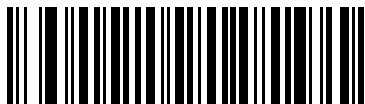

Convert UPC-E1 to UPC-A (Enable)
(1)

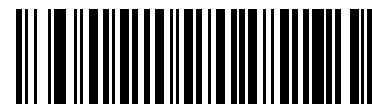

*Do Not Convert UPC-E1 to UPC-A (Disable)
(0)

EAN-8/JAN-8 Extend

Parameter # 39 (SSI # 27h)

Enable this parameter to add five leading zeros to decoded EAN-8 symbols to make them compatible in format to EAN-13 symbols. Disable this to transmit EAN-8 symbols as is.



Enable EAN/JAN Zero Extend
(1)

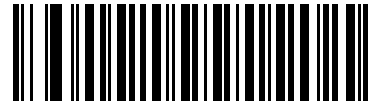

*Disable EAN/JAN Zero Extend
(0)

Bookland ISBN Format

Parameter # 576 (SSI # F1h 40h)

If you enabled Bookland EAN using [Enable/Disable Bookland EAN on page 161](#), select one of the following formats for Bookland data:

- **Bookland ISBN-10** - The RS5100 reports Bookland data starting with 978 in traditional 10-digit format with the special Bookland check digit for backward-compatibility. Data starting with 979 is not considered Bookland in this mode.
- **Bookland ISBN-13** - The RS5100 reports Bookland data (starting with either 978 or 979) as EAN-13 in 13-digit format to meet the 2007 ISBN-13 protocol.



*Bookland ISBN-10
(0)



Bookland ISBN-13
(1)



NOTE: For Bookland EAN to function properly, first enable Bookland EAN using [Enable/Disable Bookland EAN on page 161](#), then select either Decode UPC/EAN Supplementals, Autodiscriminate UPC/EAN Supplementals, or Enable 978/979 Supplemental Mode in [Decode UPC/EAN/JAN Supplementals on page 162](#).

UCC Coupon Extended Code

Parameter # 85 (SSI # 55h)

Enable this parameter to decode UPC-A barcodes starting with digit '5', EAN-13 barcodes starting with digit '99', and UPC-A/GS1-128 Coupon Codes. UPCA, EAN-13, and GS1-128 must be enabled to scan all types of Coupon Codes.

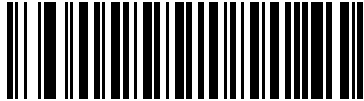

Enable UCC Coupon Extended Code
(1)



*Disable UCC Coupon Extended Code
(0)



NOTE: See [UPC/EAN/JAN Supplemental Redundancy on page 165](#) to control autodiscrimination of the GS1-128 (right half) of a coupon code.

Coupon Report

Parameter # 730 (SSI # F1h DAh)

Select an option to determine which type of coupon format to support.

- Select **Old Coupon Format** to support UPC-A/GS1-128 and EAN-13/GS1-128.
- Select **New Coupon Format** as an interim format to support UPC-A/GS1-DataBar and EAN-13/GS1-DataBar.
- If you select **Autodiscriminate Format**, the RS5100 supports both **Old Coupon Format** and **New Coupon Format**.



Old Coupon Format
(0)

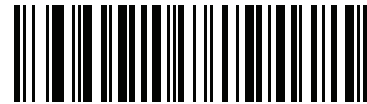

***New Coupon Format**
(1)



Autodiscriminate Coupon Format
(2)

ISSN EAN

Parameter # 617 (SSI # F1h 69h)

To enable or disable ISSN EAN, scan the appropriate barcode below.



**Enable ISSN EAN
(1)**

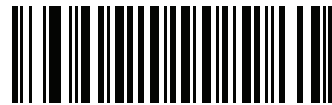

***Disable ISSN EAN
(0)**

Code 128

Enable/Disable Code 128

Parameter # 8 (SSI # 08h)

To enable or disable Code 128, scan the appropriate barcode below.

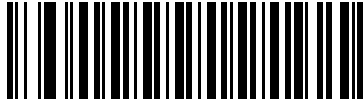

***Enable Code 128
(1)**



**Disable Code 128
(0)**

Set Lengths for Code 128

Parameter # L1 = 209 (SSI # D1h), L2 = 210 (SSI # D2h)

The length of a code refers to the number of characters (i.e., human readable characters), including check digit(s) the code contains. Set lengths for Code 128 to any length, one or two discrete lengths, or lengths within a specific range. The default is 1 to 55.



NOTE: When setting lengths for different barcode types, enter a leading zero for single digit numbers.

- **One Discrete Length** - Select this option to decode only Code 128 symbols containing a selected length. Select the length using the numeric barcodes in [Alphanumeric and Numeric Barcodes](#). For example, to decode only Code 128 symbols with 14 characters, scan **Code 128 - One Discrete Length**, then scan **1** followed by **4**. To correct an error or change the selection, scan [Cancel on page 334](#).
- **Two Discrete Lengths** - Select this option to decode only Code 128 symbols containing either of two selected lengths. Select lengths using the numeric barcodes in [Alphanumeric and Numeric Barcodes](#). For example, to decode only Code 128 symbols containing either 2 or 14 characters, select **Code 128 - Two Discrete Lengths**, then scan **0, 2, 1**, and then **4**. To correct an error or change the selection, scan [Cancel on page 334](#).
- **Length Within Range** - Select this option to decode a Code 128 symbol with a specific length range. Select lengths using numeric barcodes in [Alphanumeric and Numeric Barcodes](#). For example, to decode Code 128 symbols containing between 4 and 12 characters, first scan **Code 128 - Length Within Range**. Then scan **0, 4, 1**, and **2** (enter a leading zero for single digit numbers). To correct an error or change the selection, scan [Cancel on page 334](#).
- **Any Length** - Select this option to decode Code 128 symbols containing any number of characters within the RS5100's capability.

Set Lengths for Code 128 (continued)

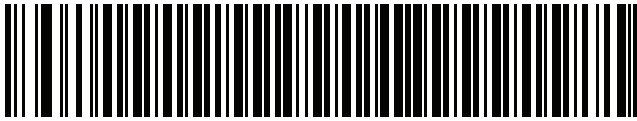

Code 128 - One Discrete Length

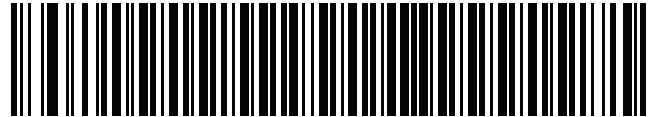

Code 128 - Two Discrete Lengths

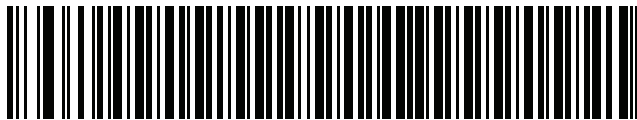

Code 128 - Length Within Range

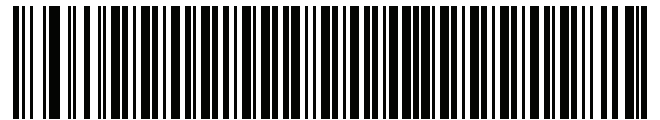

Code 128 - Any Length

Enable/Disable GS1-128 (formerly UCC/EAN-128)

Parameter # 14 (SSI # 0Eh)

To enable or disable GS1-128, scan the appropriate barcode below.

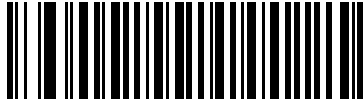

***Enable GS1-128
(1)**

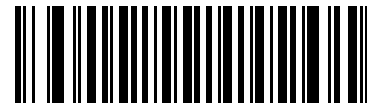

**Disable GS1-128
(0)**

Enable/Disable ISBT 128

Parameter # 84 (SSI # 54h)

ISBT 128 is a variant of Code 128 used in the blood bank industry. Scan a barcode below to enable or disable ISBT 128. If necessary, the host must perform concatenation of the ISBT data.



***Enable ISBT 128
(1)**

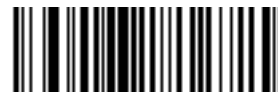

**Disable ISBT 128
(0)**

ISBT Concatenation

Parameter # 577 (SSI # F1h 41h)

Select an option for concatenating pairs of ISBT code types:

- If you select **Disable ISBT Concatenation**, the RS5100 does not concatenate pairs of ISBT codes it encounters.
- If you select **Enable ISBT Concatenation**, there must be two ISBT codes in order for the RS5100 to decode and perform concatenation. The RS5100 does not decode single ISBT symbols.
- If you select **Autodiscriminate ISBT Concatenation**, the RS5100 decodes and concatenates pairs of ISBT codes immediately. If only a single ISBT symbol is present, the RS5100 must decode the symbol the number of times set via [ISBT Concatenation Redundancy on page 183](#) before transmitting its data to confirm that there is no additional ISBT symbol.

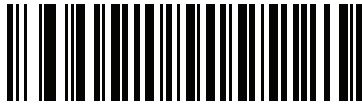

**Disable ISBT Concatenation
(0)**

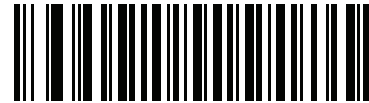

**Enable ISBT Concatenation
(1)**

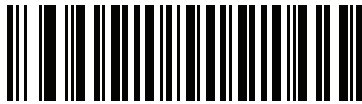

***Autodiscriminate ISBT Concatenation
(2)**

Check ISBT Table

Parameter # 578 (SSI # F1h 42h)

The ISBT specification includes a table that lists several types of ISBT barcodes that are commonly used in pairs. If you set **ISBT Concatenation** to **Enable**, enable **Check ISBT Table** to concatenate only those pairs found in this table. Other types of ISBT codes are not concatenated.



*Enable Check ISBT Table
(1)

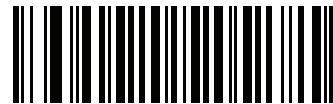

Disable Check ISBT Table
(0)

ISBT Concatenation Redundancy

Parameter # 223 (SSI # DFh)

If you set **ISBT Concatenation** to **Autodiscriminate**, use this parameter to set the number of times the RS5100 must decode an ISBT symbol before determining that there is no additional symbol.

Scan the barcode below, then scan two numeric barcodes in [Alphanumeric and Numeric Barcodes](#) to set a value between 2 and 20. Enter a leading zero for single digit numbers. To correct an error or change a selection, scan [Cancel on page 334](#). The default is 10.



ISBT Concatenation Redundancy

Code 128 Security Level

Parameter # 751 (SSI # F1h EFh)

Code 128 barcodes are vulnerable to misdecodes, particularly when Code 128 Lengths is set to **Any Length**. The RS5100 offers four levels of decode security for Code 128 barcodes. There is an inverse relationship between security and RS5100 aggressiveness. Increasing the level of security can reduce scanning aggressiveness, so select only the level of security necessary.

- **Code 128 Security Level 0:** This setting allows the RS5100 to operate in its most aggressive state, while providing sufficient security in decoding most in-spec barcodes.
- **Code 128 Security Level 1:** A barcode must be successfully read twice, and satisfy certain safety requirements before being decoded. This default setting eliminates most misdecodes.
- **Code 128 Security Level 2:** Select this option with greater barcode security requirements if **Security Level 1** fails to eliminate misdecodes.
- **Code 128 Security Level 3:** If you selected **Security Level 2**, and misdecodes still occur, select this security level to apply the highest safety requirements. A barcode must be successfully read three times before being decoded.



NOTE: Selecting this option is an extreme measure against mis-decoding severely out-of-spec barcodes. Selecting this level of security significantly impairs the decoding ability of the RS5100. If this level of security is required, try to improve the quality of the barcodes.



Code 128 Security Level 0
(0)



*Code 128 Security Level 1
(1)

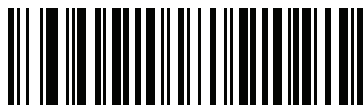

Code 128 Security Level 2
(2)



Code 128 Security Level 3
(3)

Code 128 Reduced Quiet Zone

Parameter # 1208 (SSI # F8h 04h B8h)

Scan one of the following barcodes to enable or disable decoding Code 128 barcodes with reduced quiet zones. If you select **Enable**, select a [1D Quiet Zone Level on page 258](#).



Enable Code 128 Reduced Quiet Zone
(1)



*Disable Code 128 Reduced Quiet Zone
(0)

Ignore Code 128 <FNC4>

Parameter # 1254 (SSI # F8h 04h E6h)

This feature applies to Code 128 barcodes with an embedded <FNC4> character. Enable this to strip the <FNC4> character from the decode data. The remaining characters are sent to the host unchanged. When disabled, the <FNC4> character is processed normally as per Code 128 standard.



Enable Ignore Code 128 <FNC4>
(1)



*Disable Ignore Code 128 <FNC4>
(0)

Code 128 Exclusive

Parameter # 673 (SSI # SSI F1h A1h)

This feature only allows decoding of barcode matching the Code 128 Exclusive format.

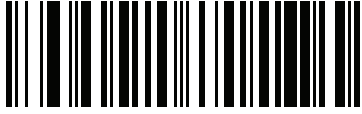

Enable
(1)



***Disable**
(0)

Code 39

Enable/Disable Code 39

Parameter # 0 (SSI # 00h)

To enable or disable Code 39, scan the appropriate barcode below.

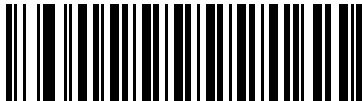

***Enable Code 39
(1)**

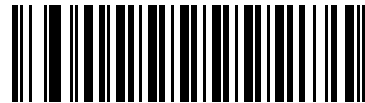

**Disable Code 39
(0)**

Enable/Disable Trioptic Code 39

Parameter # 13 (SSI # 0Dh)

Trioptic Code 39 is a variant of Code 39 used in the marking of computer tape cartridges. Trioptic Code 39 symbols always contain six characters. To enable or disable Trioptic Code 39, scan the appropriate barcode below.

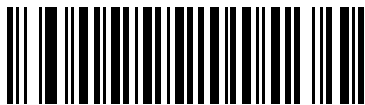

**Enable Trioptic Code 39
(1)**



***Disable Trioptic Code 39
(0)**



NOTE: You cannot enable Trioptic Code 39 and Code 39 Full ASCII simultaneously.

Convert Code 39 to Code 32

Parameter # 86 (SSI # 56h)

Code 32 is a variant of Code 39 used by the Italian pharmaceutical industry. Scan the appropriate barcode below to enable or disable converting Code 39 to Code 32.



NOTE: Code 39 must be enabled for this parameter to function.

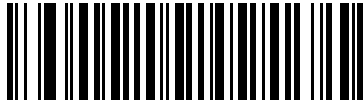

Enable Convert Code 39 to Code 32
(1)

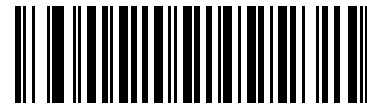

***Disable Convert Code 39 to Code 32**
(0)

Code 32 Prefix

Parameter # 231 (SSI # E7h)

Scan the appropriate barcode below to enable or disable adding the prefix character “A” to all Code 32 barcodes.



NOTE: Convert Code 39 to Code 32 must be enabled for this parameter to function.

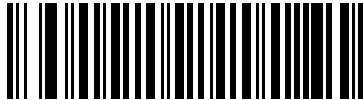

**Enable Code 32 Prefix
(1)**

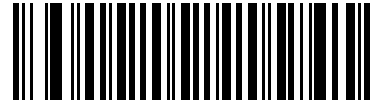

***Disable Code 32 Prefix
(0)**

Set Lengths for Code 39

Parameter # L1 = 18 (SSI # 12h), L2 = 19 (SSI # 13h)

The length of a code refers to the number of characters (i.e., human readable characters), including check digit(s) the code contains. Set lengths for Code 39 to any length, one or two discrete lengths, or lengths within a specific range. If Code 39 Full ASCII is enabled, **Length Within a Range** or **Any Length** are the preferred options. The default is 1 to 55.



NOTE: When setting lengths for different barcode types, enter a leading zero for single digit numbers.

- **One Discrete Length** - Select this option to decode only Code 39 symbols containing a selected length. Select the length using the numeric barcodes in [Alphanumeric and Numeric Barcodes](#). For example, to decode only Code 39 symbols with 14 characters, scan **Code 39 - One Discrete Length**, then scan **1** followed by **4**. To correct an error or change the selection, scan [Cancel on page 334](#).
- **Two Discrete Lengths** - Select this option to decode only Code 39 symbols containing either of two selected lengths. Select lengths using the numeric barcodes in [Alphanumeric and Numeric Barcodes](#). For example, to decode only Code 39 symbols containing either 2 or 14 characters, select **Code 39 - Two Discrete Lengths**, then scan **0, 2, 1**, and then **4**. To correct an error or change the selection, scan [Cancel on page 334](#).
- **Length Within Range** - Select this option to decode a Code 39 symbol with a specific length range. Select lengths using numeric barcodes in [Alphanumeric and Numeric Barcodes](#). For example, to decode Code 39 symbols containing between 4 and 12 characters, first scan **Code 39 - Length Within Range**. Then scan **0, 4, 1**, and **2** (enter a leading zero for single digit numbers). To correct an error or change the selection, scan [Cancel on page 334](#).
- **Any Length** - Select this option to decode Code 39 symbols containing any number of characters within the RS5100's capability.



Code 39 - One Discrete Length



Code 39 - Two Discrete Lengths



Code 39 - Length Within Range



Code 39 - Any Length

Code 39 Check Digit Verification

Parameter # 48 (SSI # 30h)

Enable this feature to check the integrity of all Code 39 symbols to verify that the data complies with specified check digit algorithm. Only Code 39 symbols which include a modulo 43 check digit are decoded. Enable this feature if the Code 39 symbols contain a Modulo 43 check digit.

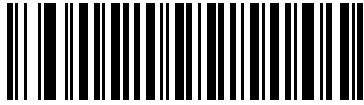

**Enable Code 39 Check Digit
(1)**

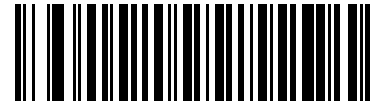

***Disable Code 39 Check Digit
(0)**

Transmit Code 39 Check Digit

Parameter # 43 (SSI # 2Bh)

Scan a barcode below to transmit Code 39 data with or without the check digit.

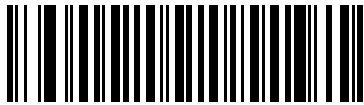

**Transmit Code 39 Check Digit (Enable)
(1)**



***Do Not Transmit Code 39 Check Digit (Disable)
(0)**



NOTE: Code 39 Check Digit Verification must be enabled for this parameter to function.

Code 39 Full ASCII Conversion

Parameter # 17 (SSI # 11h)

Code 39 Full ASCII is a variant of Code 39 which pairs characters to encode the full ASCII character set. To enable or disable Code 39 Full ASCII, scan the appropriate barcode below.

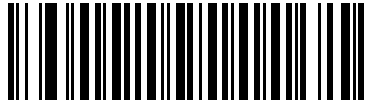

**Enable Code 39 Full ASCII
(1)**

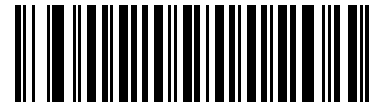

***Disable Code 39 Full ASCII
(0)**



NOTE: You cannot enable Trioptic Code 39 and Code 39 Full ASCII simultaneously.

Code 39 Full ASCII to Full ASCII Correlation is host-dependent, and is therefore described in the ASCII Character Set Table for the appropriate interface. See the [ASCII Character Sets on page 394](#).

Code 39 Security Level

Parameter # 750 (SSI # F1h EEh)

The RS5100 offers four levels of decode security for Code 39 barcodes. There is an inverse relationship between security and RS5100 aggressiveness. Increasing the level of security can reduce scanning aggressiveness, so select only the level of security necessary.

- **Code 39 Security Level 0:** This setting allows the RS5100 to operate in its most aggressive state, while providing sufficient security in decoding most in-spec barcodes.
- **Code 39 Security Level 1:** This default setting eliminates most misdecodes.
- **Code 39 Security Level 2:** Select this option with greater barcode security requirements if **Security Level 1** fails to eliminate misdecodes.
- **Code 39 Level 3:** If you selected **Security Level 2**, and misdecodes still occur, select this security level to apply the highest safety requirements.



NOTE: Selecting this option is an extreme measure against mis-decoding severely out-of-spec barcodes. Selecting this level of security significantly impairs the decoding ability of the RS5100. If this level of security is required, try to improve the quality of the barcodes.



Code 39 Security Level 0
(0)

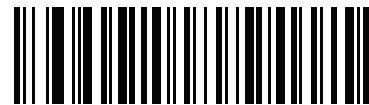

***Code 39 Security Level 1**
(1)



Code 39 Security Level 2
(2)



Code 39 Security Level 3
(3)

Code 39 Reduced Quiet Zone

Parameter # 1209 (SSI # F8h 04h B9h)

Scan one of the following barcodes to enable or disable decoding Code 39 barcodes with reduced quiet zones. If you select **Enable**, select a [1D Quiet Zone Level on page 258](#).



Enable Code 39 Reduced Quiet Zone
(1)

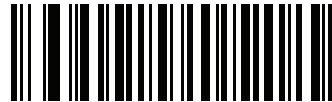

*Disable Code 39 Reduced Quiet Zone
(0)

Code 39 Buffering - Scan & Store

Parameter # 113 (SSI # 71h)

This feature allows the digital scanner to accumulate data from multiple Code 39 symbols.

Selecting the Scan and Store option (Buffer Code 39) temporarily buffers all Code 39 symbols having a leading space as a first character for later transmission. The leading space is not buffered.

Decoding a Code 39 symbol with no leading space transmits in sequence all buffered data in a first-in first-out format, plus the “triggering” symbol. See the following pages for further details.

Select **Do Not Buffer Code 39** to transmit all decoded Code 39 symbols immediately without storing them in the buffer.

Code 39 Buffering - Scan & Store (continued)

This feature affects Code 39 only. If selecting **Buffer Code 39**, we recommend configuring the digital scanner to decode Code 39 symbology only.

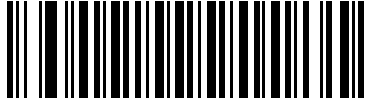

Buffer Code 39 (Enable)
(01h)

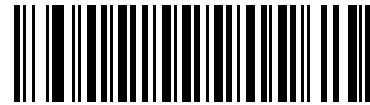

***Do Not Buffer Code 39 (Disable)**
(00h)

While there is data in the transmission buffer, you cannot select **Do Not Buffer Code 39**. The buffer holds 200 bytes of information.

To disable Code 39 buffering when there is data in the transmission buffer, first force the buffer transmission (see [Transmit Buffer on page 196](#)) or clear the buffer.

Buffer Data

To buffer data, enable Code 39 buffering and scan a Code 39 symbol with a space immediately following the start pattern.

- Unless the data overflows the transmission buffer, the digital scanner issues a low/high beep to indicate successful decode and buffering. (For overflow conditions, see [Overfilling Transmission Buffer on page 196](#).)
- The digital scanner adds the decoded data excluding the leading space to the transmission buffer.
- No transmission occurs.

Clear Transmission Buffer

To clear the transmission buffer, scan the **Clear Buffer** barcode below, which contains only a start character, a dash (minus), and a stop character.

- The digital scanner issues a short high/low/high beep.
- The digital scanner erases the transmission buffer.

- No transmission occurs.



Clear Buffer



NOTE: The Clear Buffer contains only the dash (minus) character. In order to scan this command, set Code 39 lengths to include length 1.

Transmit Buffer

There are two methods to transmit the Code 39 buffer.

1. Scan the **Transmit Buffer** barcode below, which includes only a start character, a plus (+), and a stop character.
2. The digital scanner transmits and clears the buffer.
 - The digital scanner issues a low/high beep.



Transmit Buffer

3. Scan a Code 39 barcode with a leading character other than a space.
 - The digital scanner appends new decode data to buffered data.
 - The digital scanner transmits and clears the buffer.
 - The digital scanner signals that it transmitted the buffer with a low/high beep.
 - The digital scanner transmits and clears the buffer.



NOTE: The Transmit Buffer contains only a plus (+) character. In order to scan this command, set Code 39 lengths to include length 1.

Overfilling Transmission Buffer

The Code 39 buffer holds 200 characters. If the symbol just read overflows the transmission buffer:

- The digital scanner indicates that it rejected the symbol by issuing three long, high beeps.
- No transmission occurs. The data in the buffer is not affected.

Attempt to Transmit an Empty Buffer

If you scan the **Transmit Buffer** symbol and the Code 39 buffer is empty:

- A short low/high/low beep signals that the buffer is empty.
- No transmission occurs.
- The buffer remains empty.

Code 93

Enable/Disable Code 93

Parameter # 9 (SSI # 09h)

To enable or disable Code 93, scan the appropriate barcode below.

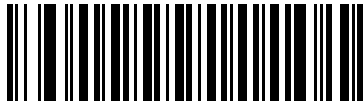

*Enable Code 93
(1)

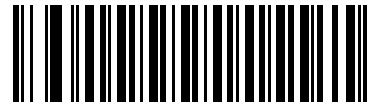

Disable Code 93
(0)

Set Lengths for Code 93

Parameter # L1 = 26 (SSI # 1Ah), L2 = 27 (SSI # 1Bh)

The length of a code refers to the number of characters (i.e., human readable characters), including check digit(s) the code contains. Set lengths for Code 93 to any length, one or two discrete lengths, or lengths within a specific range. The default is 1 to 55.

- **One Discrete Length** - Select this option to decode only Code 93 symbols containing a selected length. Select the length using the numeric barcodes in [Alphanumeric and Numeric Barcodes](#). For example, to decode only Code 93 symbols with 14 characters, scan **Code 93 - One Discrete Length**, then scan **1** followed by **4**. To correct an error or to change the selection, scan [Cancel on page 334](#).
- **Two Discrete Lengths** - Select this option to decode only Code 93 symbols containing either of two selected lengths. Select lengths using the numeric barcodes in [Alphanumeric and Numeric Barcodes](#). For example, to decode only Code 93 symbols containing either 2 or 14 characters, select **Code 93 - Two Discrete Lengths**, then scan **0, 2, 1**, and then **4**. To correct an error or to change the selection, scan [Cancel on page 334](#).
- **Length Within Range** - Select this option to decode a Code 93 symbol with a specific length range. Select lengths using the numeric barcodes in [Alphanumeric and Numeric Barcodes](#). For example, to decode Code 93 symbols containing between 4 and 12 characters, first scan **Code 93 - Length Within Range**. Then scan **0, 4, 1**, and **2** (enter a leading zero for single digit numbers). To correct an error or change the selection, scan [Cancel on page 334](#).
- **Any Length** - Scan this option to decode Code 93 symbols containing any number of characters within the RS5100's capability.

Set Lengths for Code 93 (continued)



Code 93 - One Discrete Length



Code 93 - Two Discrete Lengths



Code 93 - Length Within Range



Code 93 - Any Length

Code 11

Code 11

Parameter # 10 (SSI # 0Ah)

To enable or disable Code 11, scan the appropriate barcode below.

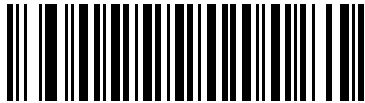

Enable Code 11
(1)

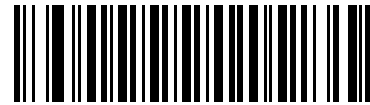

*Disable Code 11
(0)

Set Lengths for Code 11

Parameter # L1 = 28 (SSI # 1Ch), L2 = 29 (SSI # 1Dh)

The length of a code refers to the number of characters (i.e., human readable characters), including check digit(s) the code contains. Set lengths for Code 11 to any length, one or two discrete lengths, or lengths within a specific range. The default is 4 to 55.

- One Discrete Length** - Select this option to decode only Code 11 symbols containing a selected length. Select the length using the numeric barcodes in [Alphanumeric and Numeric Barcodes](#). For example, to decode only Code 11 symbols with 14 characters, scan **Code 11 - One Discrete Length**, then scan **1** followed by **4**. To correct an error or to change the selection, scan [Cancel on page 334](#).
- Two Discrete Lengths** - Select this option to decode only Code 11 symbols containing either of two selected lengths. Select lengths using the numeric barcodes in [Alphanumeric and Numeric Barcodes](#). For example, to decode only Code 11 symbols containing either 2 or 14 characters, select **Code 11 - Two Discrete Lengths**, then scan **0, 2, 1**, and then **4**. To correct an error or to change the selection, scan [Cancel on page 334](#).
- Length Within Range** - Select this option to decode a Code 11 symbol with a specific length range. Select lengths using numeric barcodes in [Alphanumeric and Numeric Barcodes](#). For example, to decode Code 11 symbols containing between 4 and 12 characters, first scan **Code 11 - Length Within Range**. Then scan **0, 4, 1**, and **2** (enter a leading zero for single digit numbers). To correct an error or change the selection, scan [Cancel on page 334](#).
- Any Length** - Scan this option to decode Code 11 symbols containing any number of characters within the RS5100's capability.

Set Lengths for Code 11 (continued)



Code 11 - One Discrete Length



Code 11 - Two Discrete Lengths



Code 11 - Length Within Range



Code 11 - Any Length

Code 11 Check Digit Verification

Parameter # 52 (SSI # 34h)

This feature allows the RS5100 to check the integrity of all Code 11 symbols to verify that the data complies with the specified check digit algorithm. This selects the check digit mechanism for the decoded Code 11 barcode. The options are to check for one check digit, check for two check digits, or disable the feature.

To enable this feature, scan the barcode below corresponding to the number of check digits encoded in the Code 11 symbols.

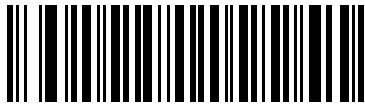

***Disable**
(0)



One Check Digit
(1)

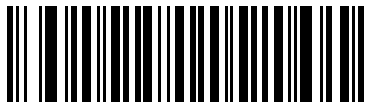

Two Check Digits
(2)

Transmit Code 11 Check Digits

Parameter # 47 (SSI # 2Fh)

This feature selects whether or not to transmit the Code 11 check digit(s).

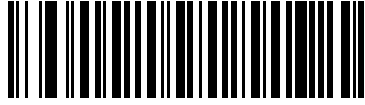

Transmit Code 11 Check Digit(s) (Enable)
(1)

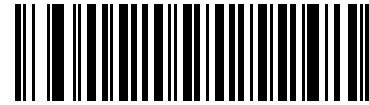

***Do Not Transmit Code 11 Check Digit(s) (Disable)**
(0)



NOTE: Code 11 Check Digit Verification must be enabled for this parameter to function.

Interleaved 2 of 5 (ITF)

Enable/Disable Interleaved 2 of 5

Parameter # 6 (SSI # 06h)

To enable or disable Interleaved 2 of 5, scan the appropriate barcode below, and select an Interleaved 2 of 5 length from the following pages.

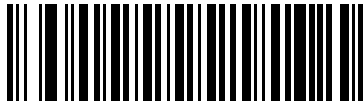

**Enable Interleaved 2 of 5
(1)**

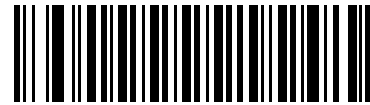

***Disable Interleaved 2 of 5
(0)**

Set Lengths for Interleaved 2 of 5

Parameter # L1 = 22 (SSI # 16h), L2 = 23 (SSI # 17h)

The length of a code refers to the number of characters (i.e., human readable characters), including check digit(s) the code contains. Set lengths for I 2 of 5 to any length, one or two discrete lengths, or lengths within a specific range. The range for Interleaved 2 of 5 lengths is 0 - 55. The default is 6 to 55.

- **One Discrete Length** - Select this option to decode only I 2 of 5 symbols containing a selected length. Select the length using the numeric barcodes in [Alphanumeric and Numeric Barcodes](#). For example, to decode only I 2 of 5 symbols with 14 characters, scan **I 2 of 5 - One Discrete Length**, then scan **1** followed by **4**. To correct an error or to change the selection, scan [Cancel on page 334](#).
- **Two Discrete Lengths** - Select this option to decode only I 2 of 5 symbols containing either of two selected lengths. Select lengths using the numeric barcodes in [Alphanumeric and Numeric Barcodes](#). For example, to decode only I 2 of 5 symbols containing either 2 or 14 characters, select **I 2 of 5 - Two Discrete Lengths**, then scan **0, 2, 1**, and then **4**. To correct an error or to change the selection, scan [Cancel on page 334](#).
- **Length Within Range** - Select this option to decode an I 2 of 5 symbol with a specific length range. Select lengths using numeric barcodes in [Alphanumeric and Numeric Barcodes](#). For example, to decode I 2 of 5 symbols containing between 4 and 12 characters, first scan **I 2 of 5 - Length Within Range**. Then scan **0, 4, 1**, and **2** (enter a leading zero for single digit numbers). To correct an error or change the selection, scan [Cancel on page 334](#).
- **Any Length** - Scan this option to decode I 2 of 5 symbols containing any number of characters within the RS5100's capability.



NOTE: Due to the construction of the I 2 of 5 symbology, it is possible for a scan line covering only a portion of the code to transmit as a complete scan, yielding less data than is encoded in the barcode. To prevent this, select specific lengths (I 2 of 5 - One Discrete Length, Two Discrete Lengths) for I 2 of 5 applications.

Set Lengths for Interleaved 2 of 5 (continued)



I 2 of 5 - One Discrete Length



I 2 of 5 - Two Discrete Lengths



I 2 of 5 - Length Within Range



I 2 of 5 - Any Length

I 2 of 5 Check Digit Verification

Parameter # 49 (SSI # 31h)

Enable this feature to check the integrity of all I 2 of 5 symbols to verify the data complies with either the specified Uniform Symbology Specification (USS), or the Optical Product Code Council (OPCC) check digit algorithm.



***Disable
(0)**



**USS Check Digit
(1)**



**OPCC Check Digit
(2)**

Transmit I 2 of 5 Check Digit

Parameter # 44 (SSI # 2Ch)

Scan the appropriate barcode below to transmit I 2 of 5 data with or without the check digit.

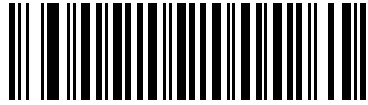

Transmit I 2 of 5 Check Digit (Enable)
(1)

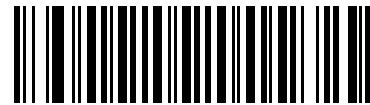

*Do Not Transmit I 2 of 5 Check Digit (Disable)
(0)

Convert I 2 of 5 to EAN-13

Parameter # 82 (SSI # 52h)

Enable this parameter to convert 14-character I 2 of 5 codes to EAN-13, and transmit to the host as EAN-13. To accomplish this, the I 2 of 5 code must be enabled, and the code must have a leading zero and a valid EAN-13 check digit.

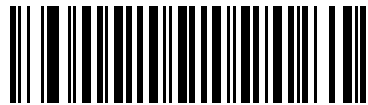

Convert I 2 of 5 to EAN-13 (Enable)
(1)



*Do Not Convert I 2 of 5 to EAN-13 (Disable)
(0)

I 2 of 5 Security Level

Parameter # 1121 (SSI # F8h 04h 61h)

Interleaved 2 of 5 barcodes are vulnerable to misdecodes, particularly when I 2 of 5 Lengths is set to **Any Length**. The RS5100 offers four levels of decode security for Interleaved 2 of 5 barcodes. There is an inverse relationship between security and RS5100 aggressiveness. Increasing the level of security can reduce scanning aggressiveness, so select only the level of security necessary.

- **I 2 of 5 Security Level 0:** This setting allows the RS5100 to operate in its most aggressive state, while providing sufficient security in decoding most in-spec barcodes.
- **I 2 of 5 Security Level 1:** A barcode must be successfully read twice, and satisfy certain safety requirements before being decoded. This default setting eliminates most misdecodes.
- **I 2 of 5 Security Level 2:** Select this option with greater barcode security requirements if **Security Level 1** fails to eliminate misdecodes.
- **I 2 of 5 Security Level 3:** If you selected **Security Level 2**, and misdecodes still occur, select this security level. The highest safety requirements are applied. A barcode must be successfully read three times before being decoded.



NOTE: Selecting this option is an extreme measure against mis-decoding severely out-of-spec barcodes. Selecting this level of security significantly impairs the decoding ability of the RS5100. If this level of security is required, try to improve the quality of the barcodes.



I 2 of 5 Security Level 0
(00h)



*I 2 of 5 Security Level 1
(01h)



I 2 of 5 Security Level 2
(02h)



I 2 of 5 Security Level 3
(03h)

I 2 of 5 Reduced Quiet Zone

Parameter # 1210 (SSI # F8h 04h BAh)

Scan one of the following barcodes to enable or disable decoding I 2 of 5 barcodes with reduced quiet zones. If you select **Enable**, select a [1D Quiet Zone Level on page 258](#).



**Enable I 2 of 5 Reduced Quiet Zone
(1)**

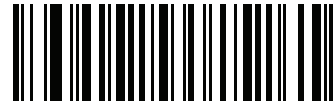

***Disable I 2 of 5 Reduced Quiet Zone
(0)**

Discrete 2 of 5 (DTF)

Enable/Disable Discrete 2 of 5

Parameter # 5 (SSI # 05h)

To enable or disable Discrete 2 of 5, scan the appropriate barcode below.

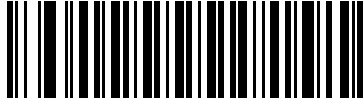

Enable Discrete 2 of 5
(1)



*Disable Discrete 2 of 5
(0)

Set Lengths for Discrete 2 of 5

Parameter # L1 = 20 (SSI # 14h), L2 = 21 (SSI # 15h)

The length of a code refers to the number of characters (i.e., human readable characters), including check digit(s) the code contains. Set lengths for D 2 of 5 to any length, one or two discrete lengths, or lengths within a specific range. The range for Discrete 2 of 5 lengths is 1 - 55.

- **One Discrete Length** - Select this option to decode only D 2 of 5 symbols containing a selected length. Select the length using the numeric barcodes in [Alphanumeric and Numeric Barcodes](#). For example, to decode only D 2 of 5 symbols with 14 characters, scan **D 2 of 5 - One Discrete Length**, then scan **1** followed by **4**. To correct an error or to change the selection, scan [Cancel on page 334](#).
- **Two Discrete Lengths** - Select this option to decode only D 2 of 5 symbols containing either of two selected lengths. Select lengths using the numeric barcodes in [Alphanumeric and Numeric Barcodes](#). For example, to decode only D 2 of 5 symbols containing either 2 or 14 characters, select **D 2 of 5 - Two Discrete Lengths**, then scan **0, 2, 1**, and then **4**. To correct an error or to change the selection, scan [Cancel on page 334](#).
- **Length Within Range** - Select this option to decode a D 2 of 5 symbol with a specific length range. Select lengths using numeric barcodes in [Alphanumeric and Numeric Barcodes](#). For example, to decode D 2 of 5 symbols containing between 4 and 12 characters, first scan **D 2 of 5 - Length Within Range**. Then scan **0, 4, 1**, and **2** (enter a leading zero for single digit numbers). To correct an error or change the selection, scan [Cancel on page 334](#).
- **Any Length** - Scan this option to decode D 2 of 5 symbols containing any number of characters within the RS5100's capability.



NOTE: Due to the construction of the D 2 of 5 symbology, it is possible for a scan line covering only a portion of the code to transmit as a complete scan, yielding less data than is encoded in the barcode. To prevent this, select specific lengths (**D 2 of 5 - One Discrete Length, Two Discrete Lengths**) for D 2 of 5 applications.

Set Lengths for Discrete 2 of 5 (continued)



D 2 of 5 - One Discrete Length



D 2 of 5 - Two Discrete Lengths



D 2 of 5 - Length Within Range



D 2 of 5 - Any Length

Codabar (NW - 7)

Enable/Disable Codabar

Parameter # 7 (SSI # 07h)

To enable or disable Codabar, scan the appropriate barcode below.

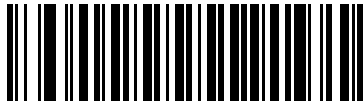

*Enable Codabar
(1)

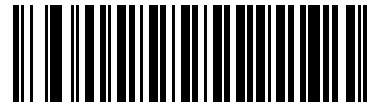

Disable Codabar
(0)

Set Lengths for Codabar

Parameter # L1 = 24 (SSI # 18h), L2 = 25 (SSI # 19h)

The length of a code refers to the number of characters (i.e., human readable characters), including check digit(s) the code contains. Set lengths for Codabar to any length, one or two discrete lengths, or lengths within a specific range. The default is 4 to 55.

- **One Discrete Length** - Select this option to decode only Codabar symbols containing a selected length. Select the length using the numeric barcodes in [Alphanumeric and Numeric Barcodes](#). For example, to decode only Codabar symbols with 14 characters, scan **Codabar - One Discrete Length**, then scan **1** followed by **4**. To correct an error or to change the selection, scan [Cancel on page 334](#).
- **Two Discrete Lengths** - Select this option to decode only Codabar symbols containing either of two selected lengths. Select lengths using the numeric barcodes in [Alphanumeric and Numeric Barcodes](#). For example, to decode only Codabar symbols containing either 2 or 14 characters, select **Codabar - Two Discrete Lengths**, then scan **0, 2, 1**, and then **4**. To correct an error or to change the selection, scan [Cancel on page 334](#).
- **Length Within Range** - Select this option to decode a Codabar symbol with a specific length range. Select lengths using numeric barcodes in [Alphanumeric and Numeric Barcodes](#). For example, to decode Codabar symbols containing between 4 and 12 characters, first scan **Codabar - Length Within Range**. Then scan **0, 4, 1**, and **2** (enter a leading zero for single digit numbers). To correct an error or change the selection, scan [Cancel on page 334](#).
- **Any Length** - Scan this option to decode Codabar symbols containing any number of characters within the RS5100's capability.

Set Lengths for Codabar (continued)



Codabar - One Discrete Length



Codabar - Two Discrete Lengths



Codabar - Length Within Range



Codabar - Any Length

CLSI Editing

Parameter # 54 (SSI # 36h)

Enable this parameter to strip the start and stop characters and insert a space after the first, fifth, and tenth characters of a 14-character Codabar symbol. Enable this feature if the host system requires this data format.



NOTE: Symbol length does not include start and stop characters.

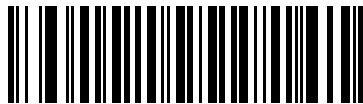

**Enable CLSI Editing
(1)**

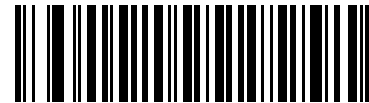

***Disable CLSI Editing
(0)**

NOTIS Editing

Parameter # 55 (SSI # 37h)

Enable this parameter to strip the start and stop characters from a decoded Codabar symbol. Enable this feature if the host system requires this data format.



**Enable NOTIS Editing
(1)**

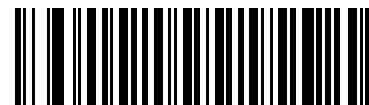

***Disable NOTIS Editing
(0)**

Codabar Upper or Lower Case Start/Stop Characters Detection

Parameter # 855 (SSI # F2h 57h)

Select whether to detect upper case or lower case Codabar start/stop characters.



Lower Case
(1)

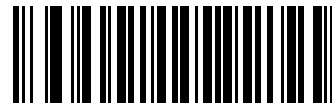

*Upper Case
(0)

Codabar Mod 16 Check Digit Verification

Parameter # 1784 (SSI # F8h 06h F8h)

Enable this feature to check the Codabar Mod 16 Check Digit to verify that the data complies with the specified check digit algorithm.



Enable Codabar Mod 16 Checkdigit
(1)



* Disable Codabar Mod 16 Checkdigit
(0)

MSI

Enable/Disable MSI

Parameter # 11 (SSI # 0Bh)

To enable or disable MSI, scan the appropriate barcode below.

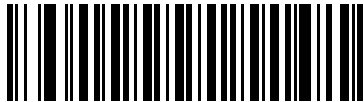

Enable MSI
(1)

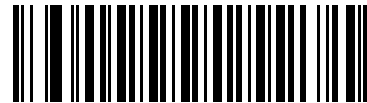

*Disable MSI
(0)

Set Lengths for MSI

Parameter # L1 = 30 (SSI # 1Eh), L2 = 31 (SSI # 1Fh)

The length of a code refers to the number of characters (i.e., human readable characters), including check digit(s) the code contains. Set lengths for MSI to any length, one or two discrete lengths, or lengths within a specific range. The default is 4 to 55.

- **One Discrete Length** - Select this option to decode only MSI symbols containing a selected length. Select the length using the numeric barcodes in [Alphanumeric and Numeric Barcodes](#). For example, to decode only MSI symbols with 14 characters, scan **MSI - One Discrete Length**, then scan **1** followed by **4**. To correct an error or to change the selection, scan [Cancel on page 334](#).
- **Two Discrete Lengths** - Select this option to decode only MSI symbols containing either of two selected lengths. Select lengths using the numeric barcodes in [Alphanumeric and Numeric Barcodes](#). For example, to decode only MSI symbols containing either 2 or 14 characters, select **MSI - Two Discrete Lengths**, then scan **0, 2, 1**, and then **4**. To correct an error or to change the selection, scan [Cancel on page 334](#).
- **Length Within Range** - Select this option to decode a MSI symbol with a specific length range. Select lengths using numeric barcodes in [Alphanumeric and Numeric Barcodes](#). For example, to decode MSI symbols containing between 4 and 12 characters, first scan **MSI - Length Within Range**. Then scan **0, 4, 1**, and **2** (enter a leading zero for single digit numbers). To correct an error or change the selection, scan [Cancel on page 334](#).
- **Any Length** - Scan this option to decode MSI symbols containing any number of characters within the RS5100's capability.

Set Lengths for MSI (continued)



NOTE: Due to the construction of the MSI symbology, it is possible for a scan line covering only a portion of the code to transmit as a complete scan, yielding less data than is encoded in the barcode. To prevent this, select specific lengths (**MSI - One Discrete Length, Two Discrete Lengths**) for MSI applications.



MSI - One Discrete Length



MSI - Two Discrete Lengths

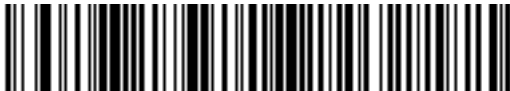

MSI - Length Within Range

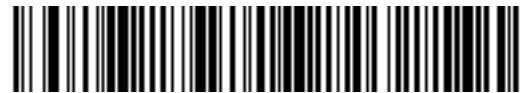

MSI - Any Length

MSI Check Digits

Parameter # 50 (SSI # 32h)

0 - Doesn't check MSI check digit. Decodes MSI with no check digit.

1 - MSI barcodes with 1 check digit. This is the default.

2 - MSI barcodes with 2 check digits.

See [MSI Check Digit Algorithm on page 221](#) for the selection of second digit algorithms.



NOTE: This parameter's value semantics have changed from previous models of Zebra scanners. As a result, this parameter is not compatible with current Zebra host devices. An update on the Zebra host devices is in progress.



None (0)



* One MSI Check Digit (1)



Two MSI Check Digits
(2)

Transmit MSI Check Digit(s)

Parameter # 46 (SSI # 2Eh)

Scan a barcode below to transmit MSI data with or without the check digit.

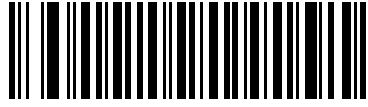

Transmit MSI Check Digit(s) (Enable)
(1)



***Do Not Transmit MSI Check Digit(s) (Disable)**
(0)

MSI Check Digit Algorithm

Parameter # 51 (SSI # 33h)

Two algorithms are possible for the verification of the second MSI check digit. Select the barcode below corresponding to the algorithm used to encode the check digit.



MOD 10/MOD 11
(0)

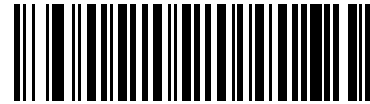

***MOD 10/MOD 10**
(1)

Chinese 2 of 5

Enable/Disable Chinese 2 of 5

Parameter # 408 (SSI # F0h 98h)

To enable or disable Chinese 2 of 5, scan the appropriate barcode below.

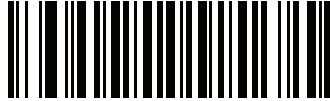

**Enable Chinese 2 of 5
(1)**

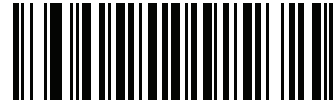

***Disable Chinese 2 of 5
(0)**

Matrix 2 of 5

Enable/Disable Matrix 2 of 5

Parameter # 618 (SSI # F1h 6Ah)

To enable or disable Matrix 2 of 5, scan the appropriate barcode below.

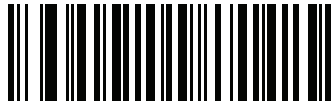

Enable Matrix 2 of 5
(1)



*Disable Matrix 2 of 5
(0)

Set Lengths for Matrix 2 of 5

Parameter # L1 = 619 (SSI # F1h 6Bh), L2 = 620 (SSI # F1h 6Ch)

The length of a code refers to the number of characters (i.e., human readable characters), including check digit(s) the code contains. Set lengths for Matrix 2 of 5 to any length, one or two discrete lengths, or lengths within a specific range. The default is 4 to 55.

- **One Discrete Length** - Select this option to decode only Matrix 2 of 5 symbols containing a selected length. Select the length using the numeric barcodes in [Alphanumeric and Numeric Barcodes](#). For example, to decode only Matrix 2 of 5 symbols with 14 characters, scan **Matrix 2 of 5 - One Discrete Length**, then scan **1** followed by **4**. To correct an error or to change the selection, scan [Cancel on page 334](#).
- **Two Discrete Lengths** - Select this option to decode only Matrix 2 of 5 symbols containing either of two selected lengths. Select lengths using the numeric barcodes in [Alphanumeric and Numeric Barcodes](#). For example, to decode only Matrix 2 of 5 symbols containing either 2 or 14 characters, select **Matrix 2 of 5 - Two Discrete Lengths**, then scan **0**, **2**, **1**, and then **4**. To correct an error or to change the selection, scan [Cancel on page 334](#).
- **Length Within Range** - Select this option to decode a Matrix 2 of 5 symbol with a specific length range. Select lengths using the numeric barcodes in [Alphanumeric and Numeric Barcodes](#). For example, to decode Matrix 2 of 5 symbols containing between 4 and 12 characters, first scan **Matrix 2 of 5 - Length Within Range**. Then scan **0**, **4**, **1**, and **2** (enter a leading zero for single digit numbers). To correct an error or change the selection, scan [Cancel on page 334](#).
- **Any Length** - Scan this option to decode Matrix 2 of 5 symbols containing any number of characters within the RS5100's capability.

Set Lengths for Matrix 2 of 5 (continued)



***Matrix 2 of 5 - One Discrete Length**

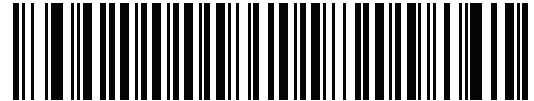

Matrix 2 of 5 - Two Discrete Lengths



Matrix 2 of 5 - Length Within Range

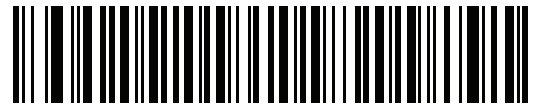

Matrix 2 of 5 - Any Length

Matrix 2 of 5 Check Digit

Parameter # 622 (SSI # F1h 6Eh)

The check digit is the last character of the symbol used to verify the integrity of the data. Scan the appropriate barcode below to transmit the barcode data with or without the Matrix 2 of 5 check digit.



Enable Matrix 2 of 5 Check Digit
(1)



*Disable Matrix 2 of 5 Check Digit
(0)

Transmit Matrix 2 of 5 Check Digit

Parameter # 623 (SSI # F1h 6Fh)

Scan a barcode below to transmit Matrix 2 of 5 data with or without the check digit.



Transmit Matrix 2 of 5 Check Digit
(1)



*Do Not Transmit Matrix 2 of 5 Check Digit
(0)

Korean 3 of 5

Enable/Disable Korean 3 of 5

Parameter # 581 (SSI # F1h 45h)

To enable or disable Korean 3 of 5, scan the appropriate barcode below.



NOTE: The length for Korean 3 of 5 is fixed at 6.

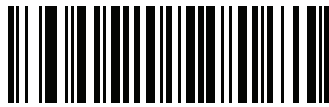

Enable Korean 3 of 5
(1)



***Disable Korean 3 of 5**
(0)

Inverse 1D

Parameter # 586 (SSI # F1h 4Ah)

This parameter sets the 1D inverse decoder setting. Options are:

- **Regular Only** - the RS5100 decodes regular 1D barcodes only.
- **Inverse Only** - the RS5100 decodes inverse 1D barcodes only.
- **Inverse Autodetect** - the RS5100 decodes both regular and inverse 1D barcodes.



***Regular**
(0)



Inverse Only
(1)



Inverse Autodetect
(2)

GS1 DataBar

The variants of GS1 DataBar are DataBar-14, DataBar Expanded, and DataBar Limited. The limited and expanded versions have stacked variants. Scan the appropriate barcodes to enable or disable each variant of GS1 DataBar.

GS1 DataBar-14

Parameter # 338 (SSI # F0h 52h)

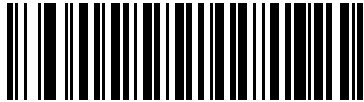

***Enable GS1 DataBar-14
(1)**

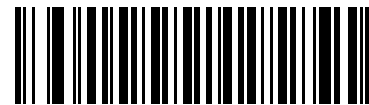

**Disable GS1 DataBar-14
(0)**

GS1 DataBar Limited

Parameter # 339 (SSI # F0h 53h)

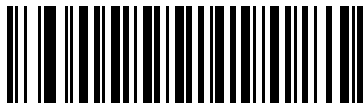

***Enable GS1 DataBar Limited
(1)**

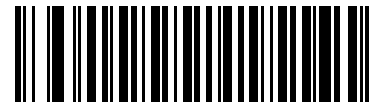

**Disable GS1 DataBar Limited
(0)**

GS1 DataBar Expanded

Parameter # 340 (SSI # F0h 54h)

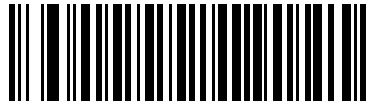

***Enable GS1 DataBar Expanded
(1)**

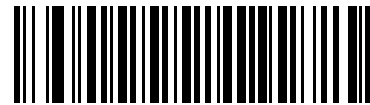

**Disable GS1 DataBar Expanded
(0)**

Convert GS1 DataBar to UPC/EAN

Parameter # 397 (SSI # F0h, 8Dh)

This parameter only applies to GS1 DataBar-14 and GS1 DataBar Limited symbols not decoded as part of a Composite symbol. Enable this to strip the leading '010' from DataBar-14 and DataBar Limited symbols encoding a single zero as the first digit, and report the barcode as EAN-13.

For barcodes beginning with two or more zeros but not six zeros, this parameter strips the leading '0100' and reports the barcode as UPC-A. The UPC-A Preamble parameter that transmits the system character and country code applies to converted barcodes. Note that neither the system character nor the check digit can be stripped.



**Enable Convert GS1 DataBar to UPC/EAN
(1)**



***Disable Convert GS1 DataBar to UPC/EAN
(0)**

GS1 DataBar Limited Security Level

Parameter # 728 (SSI # F1h D8h)

The RS5100 offers four levels of decode security for GS1 DataBar Limited barcodes. There is an inverse relationship between security and RS5100 aggressiveness. Increasing the level of security may result in reduced aggressiveness in scanning, so choose only that level of security necessary.

- Level 1 – No clear margin required. This complies with the original GS1 standard, yet might result in erroneous decoding of the DataBar Limited barcode when scanning some UPC symbols that start with digits “9” and “7”
- Level 2 – Automatic risk detection. This level of security may result in erroneous decoding of DataBar Limited barcodes when scanning some UPC symbols. The RS5100 defaults to Level 3, otherwise to Level 1.
- Level 3 – Security level reflects newly proposed GS1 standard that requires a 5 times trailing clear margin.
- Level 4 – Security level extends beyond the standard required by GS1. This level of security requires a 5 times leading and trailing clear margin.



GS1 DataBar Limited Security Level 1
(1)

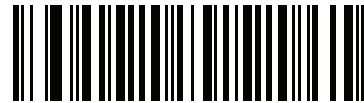

GS1 DataBar Limited Security Level 2
(2)



*GS1 DataBar Limited Security Level 3
(3)



GS1 DataBar Limited Security Level 4
(4)

Composite

Composite CC-C

Parameter # 341 (SSI # F0h 55h)

Scan a barcode below to enable or disable Composite barcodes of type CC-C.

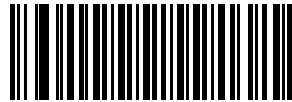

Enable CC-C
(1)

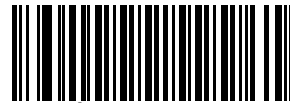

*Disable CC-C
(0)

Composite CC-A/B

Parameter # 342 (SSI # F0h 56h)

Scan a barcode below to enable or disable Composite barcodes of type CC-A/B.



Enable CC-A/B
(1)

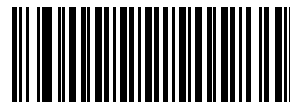

*Disable CC-A/B
(0)

Composite TLC-39

Parameter # 371 (SSI # F0h 73h)

Scan a barcode below to enable or disable Composite barcodes of type TLC-39.

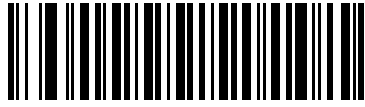

Enable TLC39
(1)

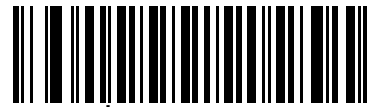

*Disable TLC39
(0)

UPC Composite Mode

Parameter # 344 (SSI # F0h 58h)

Select an option for linking UPC symbols with a 2D symbol during transmission as if they were one symbol:

- Select **UPC Never Linked** to transmit UPC barcodes regardless of whether a 2D symbol is detected.
- Select **UPC Always Linked** to transmit UPC barcodes and the 2D portion. If 2D is not present, the UPC barcode does not transmit.
- If you select **Autodiscriminate UPC Composites**, the RS5100 determines if there is a 2D portion, then transmits the UPC, as well as the 2D portion if present.

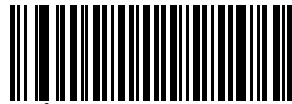

*UPC Never Linked
(0)

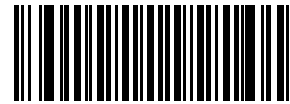

UPC Always Linked
(1)

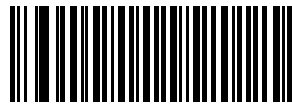

Autodiscriminate UPC Composites
(2)

Composite Beep Mode

Parameter # 398 (SSI # F0h, 8Eh)

To select the number of decode beeps when a composite barcode is decoded, scan the appropriate barcode.

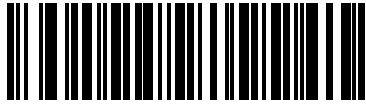

Single Beep after both are decoded
(0)

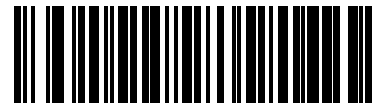

*Beep as each code type is decoded
(1)

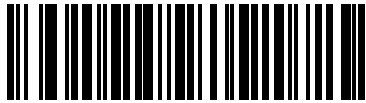

Double Beep after both are decoded
(2)

GS1-128 Emulation Mode for UCC/EAN Composite Codes

Parameter # 427 (SSI # F0h, ABh)

Select whether to enable or disable this mode.



Enable GS1-128 Emulation Mode for
UCC/EAN Composite Codes
(1)



*Disable GS1-128 Emulation Mode for
UCC/EAN Composite Codes
(0)

2D Symbologies

Enable/Disable PDF417

Parameter # 15 (SSI # 0Fh)

To enable or disable PDF417, scan the appropriate barcode below.



***Enable PDF417**
(1)



Disable PDF417
(0)

Enable/Disable MicroPDF417

Parameter # 227 (SSI # E3h)

To enable or disable MicroPDF417, scan the appropriate barcode below.



Enable MicroPDF417
(1)



***Disable MicroPDF417**
(0)

Code 128 Emulation

Parameter # 123 (SSI # 7Bh)

Enable this parameter to transmit data from certain MicroPDF417 symbols as Code 128. [AIM Code ID Character on page 143](#) must be enabled for this parameter to work.

Enable Code 128 Emulation to transmit these MicroPDF417 symbols with one of the following prefixes:

-]C1 if the first codeword is 903-905
-]C2 if the first codeword is 908 or 909
-]C0 if the first codeword is 910 or 911

Disable Code 128 Emulation to transmit these MicroPDF417 symbols with one of the following prefixes:

-]L3 if the first codeword is 903-905
-]L4 if the first codeword is 908 or 909
-]L5 if the first codeword is 910 or 911

Scan a barcode below to enable or disable Code 128 Emulation.



NOTE: Linked MicroPDF codewords 906, 907, 912, 914, and 915 are not supported. Use GS1 Composites instead.



Enable Code 128 Emulation
(1)



***Disable Code 128 Emulation**
(0)

Data Matrix

Parameter # 292 (SSI # F0h, 24h)

To enable or disable Data Matrix, scan the appropriate barcode below.



***Enable Data Matrix
(1)**



**Disable Data Matrix
(0)**

GS1 Data Matrix

Parameter # 1336 (SSI # F8h 05h 38h)

To enable or disable GS1 Data Matrix, scan the appropriate barcode below.

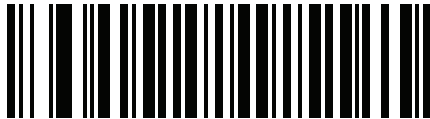

***Disable GS1 Data Matrix
(0)**

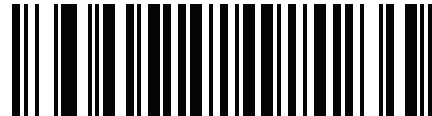

**Enable GS1 Data Matrix
(1)**

Data Matrix Inverse

Parameter # 588 (SSI # F1h 4Ch)

This parameter sets the Data Matrix inverse decoder setting. Options are:

- **Regular Only** - the RS5100 decodes regular Data Matrix barcodes only.
- **Inverse Only** - the RS5100 decodes inverse Data Matrix barcodes only.
- **Inverse Autodetect** - the RS5100 decodes both regular and inverse Data Matrix barcodes.



Regular
(0)



Inverse Only
(1)



*Inverse Autodetect
(2)

Maxicode

Parameter # 294 (SSI # F0h, 26h)

To enable or disable Maxicode, scan the appropriate barcode below.



Enable Maxicode
(1)



*Disable Maxicode
(0)

QR Code

Parameter # 293 (SSI # F0h, 25h)



NOTE: Inverse QR barcodes decode if QR Code is enabled.

To enable or disable QR Code, scan the appropriate barcode below.



***Enable QR Code**
(1)



Disable QR Code
(0)

GS1 QR

Parameter # 1343 (SSI # F8h 05h 3Fh)

To enable or disable GS1 QR, scan the appropriate barcode below.



***Disable GS1 QR**
(0)



Enable GS1 QR
(1)

MicroQR

Parameter # 573 (SSI # F1h 3Dh)

To enable or disable MicroQR, scan the appropriate barcode below.

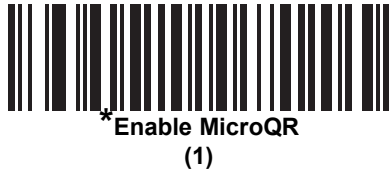

Aztec

Parameter # 574 (SSI # F1h 3Eh)

To enable or disable Aztec, scan the appropriate barcode below.



Aztec Inverse

Parameter # 589 (SSI # F1h 4Dh)

This parameter sets the Aztec inverse decoder setting. Options are:

- **Regular Only** - the RS5100 decodes regular Aztec barcodes only.
- **Inverse Only** - the RS5100 decodes inverse Aztec barcodes only.
- **Inverse Autodetect** - the RS5100 decodes both regular and inverse Aztec barcodes.



Regular
(0)



Inverse Only
(1)



*Inverse Autodetect
(2)

Han Xin

Parameter # 1167 (SSI # F8h 04h 8Fh)

To enable or disable Han Xin, scan the appropriate barcode below.

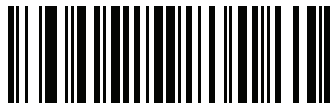

Enable Han Xin
(1)



*Disable Han Xin
(0)

Han Xin Inverse

Parameter # 1168 (SSI # F8h 04h 90h)

Select a Han Xin inverse decoder setting:

- **Regular Only** - the decoder decodes Han Xin barcodes with normal reflectance only.
- **Inverse Only** - the decoder decodes Han Xin barcodes with inverse reflectance only.

- **Inverse Autodetect** - the decoder decodes both regular and inverse Han Xin barcodes.



***Regular
(0)**

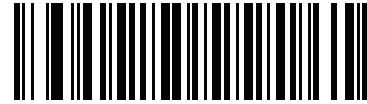

**Inverse Only
(1)**



**Inverse Autodetect
(2)**

DotCode

Parameter # 1906 (SSI # F8 07 72h)



NOTE This parameter is only supported on the SR and HD configurations.

Scan one of the following barcodes to enable or disable DotCode.



*** Disable DotCode
(0)**



**Enable DotCode
(1)**

DotCode Inverse

Parameter # 1907 (SSI # F8 07 73h)



NOTE This parameter is only supported on the SR and HD configurations.

Scan one of the following barcodes to select a DotCode Inverse decoder setting. Setting options are:

- **Regular Only** - Decoder decodes DotCode barcodes with normal reflectance only.
- **Inverse Only** - Decoder decodes DotCode barcodes with inverse reflectance only.
- **Inverse Autodetect** - Decoder decodes both regular and inverse DotCode barcodes.



**Regular
(0)**



**Inverse Only
(1)**



*** Autodetect
(2)**

DotCode Mirrored

Parameter # 1908 (SSI # F8 07 74h)



NOTE This parameter is only supported on the SR and HD configurations.

Scan one of the following barcodes to select a DotCode Mirror decoder setting:

- **Non-Mirrored Only** - Digital scanner decodes non-mirrored DotCode barcodes only.
- **Mirrored Only** - Digital scanner decodes mirrored DotCode barcodes only.
- **Autodetect** - Digital scanner decodes both mirrored and non-mirrored DotCode barcodes.



Never
(0)



Always
(1)



*** Autodetect**
(2)

DotCode Prioritize

Parameter # 1937 (SSI # F8 07 91h)



NOTE This parameter is only supported on the SR and HD configurations.

Enable DotCode Prioritize to give priority to DotCode decoding as compared to other symbologies.



* **Disable**



Enable

Postal Codes

US Postnet

Parameter # 89 (SSI # 59h)

To enable or disable US Postnet, scan the appropriate barcode below.



Enable US Postnet
(1)



*Disable US Postnet
(0)

US Planet

Parameter # 90 (SSI # 5Ah)

To enable or disable US Planet, scan the appropriate barcode below.



Enable US Planet
(1)



*Disable US Planet
(0)

Transmit US Postal Check Digit

Parameter # 95 (SSI # 5Fh)

Select whether to transmit US Postal data, which includes both US Postnet and US Planet, with or without the check digit.



***Transmit US Postal Check Digit
(1)**



**Do Not Transmit US Postal Check Digit
(0)**

UK Postal

Parameter # 91 (SSI # 5Bh)

To enable or disable UK Postal, scan the appropriate barcode below.



**Enable UK Postal
(1)**

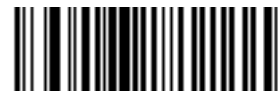

***Disable UK Postal
(0)**

Transmit UK Postal Check Digit

Parameter # 96 (SSI # 60h)

Select whether to transmit UK Postal data with or without the check digit.



***Transmit UK Postal
Check Digit
(1)**



**Do Not Transmit UK Postal Check Digit
(0)**

Japan Postal

Parameter # 290 (SSI # F0h, 22h)

To enable or disable Japan Postal, scan the appropriate barcode below.



**Enable Japan Postal
(1)**



***Disable Japan Postal
(0)**

Australia Post

Parameter # 291 (SSI # F0h, 23h)

To enable or disable Australia Post, scan the appropriate barcode below.



Enable Australia Post
(1)



***Disable Australia Post**
(0)

Australia Post Format

Parameter # 718 (SSI # F1h, CEh)

To select one of the following formats for Australia Post, scan the appropriate barcode below:

- **Autodiscriminate** (or Smart mode) - Attempt to decode the Customer Information Field using the N and C Encoding Tables.



NOTE: This option increases the risk of misdecodes because the encoded data format does not specify the Encoding Table used for encoding.

- **Raw Format** - Output raw bar patterns as a series of numbers 0 through 3.
- **Alphanumeric Encoding** - Decode the Customer Information Field using the C Encoding Table.
- **Numeric Encoding** - Decode the Customer Information Field using the N Encoding Table.

For more information on Australia Post Encoding Tables, refer to the Australia Post Customer Barcoding Technical Specifications available at auspost.com.au.



*Autodiscriminate
(0)



Raw Format
(1)

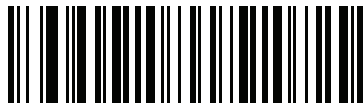

Alphanumeric Encoding
(2)



Numeric Encoding
(3)

Netherlands KIX Code

Parameter # 326 (SSI # F0h, 46h)

To enable or disable Netherlands KIX Code, scan the appropriate barcode below.



Enable Netherlands KIX Code
(1)



*Disable Netherlands KIX Code
(0)

USPS 4CB/One Code/Intelligent Mail

Parameter # 592 (SSI # F1h 50h)

To enable or disable USPS 4CB/One Code/Intelligent Mail, scan the appropriate barcode below.



Enable USPS 4CB/One Code/Intelligent Mail
(1)



*Disable USPS 4CB/One Code/Intelligent Mail
(0)

UPU FICS Postal

Parameter # 611 (SSI # F1h 63h)

To enable or disable UPU FICS Postal, scan the appropriate barcode below.



Enable UPU FICS Postal
(1)



*Disable UPU FICS Postal
(0)

Mailmark

Parameter # 1337 (SSI # F8h 05h 39h)

To enable or disable Mailmark, scan the appropriate barcode below.

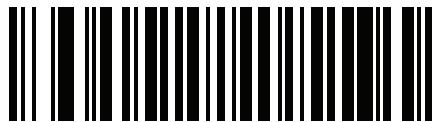

*Disable Mailmark
(0)

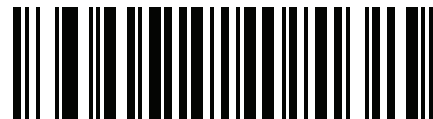

Enable Mailmark
(1)

Canada Post

Parameter # 92 (SSI # 5Ch)

To enable or disable Canada Post, scan the appropriate barcode below.

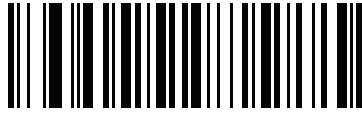

***Disable Canada Post
(0)**

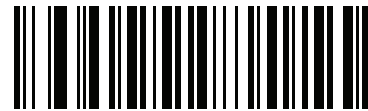

**Enable Canada Post
(1)**

Posti LAPA 4-State Code

Parameter # 2031 (SSI # F8 07EF)

To enable or disable Posti LAPA, scan the appropriate barcode below.



***Disable Posti LAPA
(0)**



**Enable Posti LAPA
(1)**

Symbology-Specific Security Levels

Redundancy Level

Parameter # 78 (SSI # 4Eh)

The RS5100 offers four levels of decode redundancy. Select higher redundancy levels for decreasing levels of barcode quality. As redundancy levels increase, the RS5100's aggressiveness decreases.

Select the redundancy level appropriate for the barcode quality.

Redundancy Level 1

The following code types must be successfully read twice before being decoded:

Table 11 Redundancy Level 1 Codes

Code Type	Code Length
Codabar	8 characters or less
MSI	4 characters or less
D 2 of 5	8 characters or less
I 2 of 5	8 characters or less

Redundancy Level 2

The following code types must be successfully read twice before being decoded:

Table 12 Redundancy Level 2 Codes

Code Type	Code Length
All	All

Redundancy Level 3

Code types other than the following must be successfully read twice before being decoded. The following codes must be read three times:

Table 13 Redundancy Level 3 Codes

Code Type	Code Length
MSI	4 characters or less
D 2 of 5	8 characters or less
I 2 of 5	8 characters or less
Codabar	8 characters or less

Redundancy Level 4

The following code types must be successfully read three times before being decoded:

Table 14 Redundancy Level 4 Codes

Code Type	Code Length
All	All

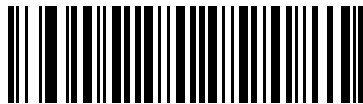

*Redundancy Level 1
(1)

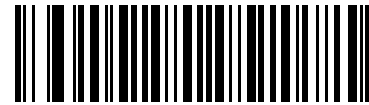

Redundancy Level 2
(2)

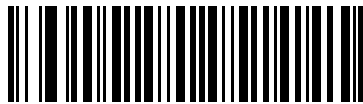

Redundancy Level 3
(3)

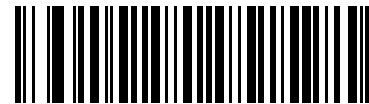

Redundancy Level 4
(4)

Security Level

Parameter # 77 (SSI # 4Dh)

The RS5100 offers four levels of decode security for delta barcodes, which include the Code 128 family, UPC/EAN, and Code 93. Select increasing levels of security for decreasing levels of barcode quality. There is an inverse relationship between security and RS5100 aggressiveness, so choose only that level of security necessary for any given application.

- **Security Level 0:** This setting allows the RS5100 to operate in its most aggressive state, while providing sufficient security in decoding most “in-spec” barcodes.
- **Security Level 1:** This default setting eliminates most misdecodes.
- **Security Level 2:** Select this option if Security level 1 fails to eliminate misdecodes.
- **Security Level 3:** If you selected Security Level 2 and misdecodes still occur, select this security level. Be advised, selecting this option is an extreme measure against mis-decoding severely out of spec barcodes. Selecting this level of security significantly impairs the decoding ability of the RS5100. If you need this level of security, try to improve the quality of the barcodes.

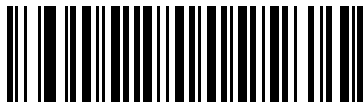

Security Level 0
(0)



*Security Level 1
(1)

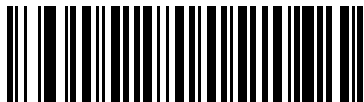

Security Level 2
(2)



Security Level 3
(3)

1D Quiet Zone Level

Parameter # 1288 (SSI # F8h 05h 08h)

This feature sets the level of aggressiveness in decoding barcodes with a reduced quiet zone (the area in front of and at the end of a barcode), and applies to symbologies enabled by a Reduced Quiet Zone parameter. Because higher levels increase the decoding time and risk of misdecodes, Symbol Technologies strongly recommends enabling only the symbologies which require higher quiet zone levels, and leaving Reduced Quiet Zone disabled for all other symbologies. Options are:

- 0 - The RS5100 performs normally in terms of quiet zone.
- 1 - The RS5100 performs more aggressively in terms of quiet zone.
- 2 - The RS5100 only requires one side EB (end of barcode) for decoding.
- 3 - The RS5100 decodes anything in terms of quiet zone or end of barcode.

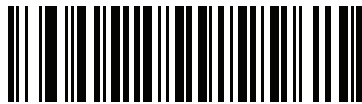

1D Quiet Zone Level 0
(0)

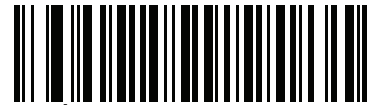

*1D Quiet Zone Level 1
(1)

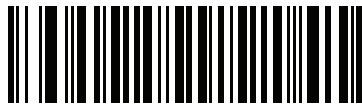

1D Quiet Zone Level 2
(2)

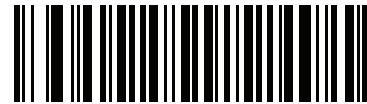

1D Quiet Zone Level 3
(3)

Intercharacter Gap Size

Parameter # 381 (SSI # F0h, 7Dh)

The Code 39 and Codabar symbologies have an intercharacter gap that is typically quite small. Due to various barcode-printing technologies, this gap can grow larger than the maximum size allowed, preventing the RS5100 from decoding the symbol. If this problem occurs, scan the **Large Intercharacter Gaps** parameter to tolerate these out-of-specification barcodes.

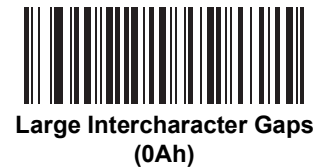

Report Version

Scan the barcode below to report the version of software installed in the RS5100.



Macro PDF Features

Macro PDF is a special feature for concatenating multiple PDF symbols into one file. The RS5100 can decode symbols that are encoded with this feature, and can store more than 64 Kb of decoded data stored in up to 50 MacroPDF symbols.



CAUTION: When printing, keep each Macro PDF sequence separate, as each sequence has unique identifiers. Do not mix barcodes from several Macro PDF sequences, even if they encode the same data. When scanning Macro PDF sequences, scan the entire Macro PDF sequence without interruption. If, when scanning a mixed sequence, the RS5100 emits two long low beeps (Low/Low) this indicates an inconsistent file ID or inconsistent symbology error.

Flush Macro PDF Buffer

This flushes the buffer of all decoded Macro PDF data stored to that point, transmits it to the host device, and aborts from Macro PDF mode.



Flush Macro PDF Buffer

Abort Macro PDF Entry

This clears all currently-stored Macro PDF data in the buffer without transmission and aborts from Macro PDF mode.



Abort Macro PDF Entry

Digimarc Barcode

Introduction

Digimarc Barcode is an invisible machine-readable code.

Digimarc Symbology

Digimarc codes are reported as UPC-A, UPC-E, EAN-13, or GS1 DataBar Expanded.



NOTE: Converting the Digimarc reported code types to other barcode types is not supported.

AIM and Symbol code IDs are supported for the reported Digimarc code types.

Picklist

The Digimarc decoder searches configured block areas of the image for Digimarc codes, and operates the same regardless of whether Picklist Mode is enabled or disabled.



NOTE: Decode time can be greater in Picklist Mode due to the additional processing required by the system and decoder.

Digimarc Digital Watermarks

Parameter # 1687 (SSI # F8h 06h 97h)

Scan the appropriate barcode to enable or disable the Digimarc Digital Watermarks code.



**Enable Digimarc Digital Watermarks
(1)**



***Disable Digimarc Digital Watermarks
(0)**

Data Formatting: ADF, MDF, Preferred Symbol

Introduction

This chapter briefly describes the Zebra features available for customizing scanner operation.

Advanced Data Formatting (ADF)

Advanced Data Formatting (ADF) allows customizing data before transmission to the host device. Use ADF to edit scanned data to suit the host application's requirements. With ADF you scan one barcode per trigger pull. ADF is programmed using 123Scan.

For a video on Creating an Advanced Data Formatting (ADF) Rule using 123Scan, go to: www.zebra.com/ScannerHowToVideos.

For additional information, refer to the Advanced Data Formatting Programmer Guide.

Multicode Data Formatting (Hand-held Mode Only)

Multicode Data Formatting (MDF) enables a 2D scanner to scan all barcodes on a label with a single trigger pull, and then modify and transmit the data to meet host application requirements. MDF supports programming up to nine unique labels into one scanner. MDF also supports scanning multiple barcodes on opposite sides of a box by holding the trigger.

MDF options include:

- Output all or specific barcodes.
- Control the barcode output sequence.
- Apply unique multicode data formatting (MDF) to each output barcode.
- Discard scanned data if all required barcodes are not present.

Programming a Scanner

- Using 123Scan, programming an MDF is similar to programming an ADF rule. MDF programming is saved in a 123Scan configuration file.
- MDF can be deployed to a fleet of 2D scanners using the Scanner Management Service (SMS) through a traditional SMS package.

For more information, refer to the Multicode Data Formatting and Preferred Symbol User Guide, p/n MN-002895-xx.

For a video on Creating an Multicode Data Formatting (MDF) Rule using 123Scan, go to: www.zebra.com/ScannerHowToVideos.

Preferred Symbol

Preferred Symbol is a barcode prioritization technique that enables favored decoding of high priority barcode(s). The Preferred Symbol is the only barcode that is decoded and output within the preset Preferred Symbol Timeout. During this time, the scanner attempts to decode the prioritized barcode and reports only this barcode.

For more information, refer to the Multicode Data Formatting and Preferred Symbol User Guide, p/n MN-002895-xx.

To program Preferred Symbol via 123Scan, select 123Scan > Configuration Wizard > Symbologies screen, and then select Preferred Symbol from the drop-down menu. Preferred Symbol programming is saved in the 123Scan configuration file.

OCR Programming

Introduction

This chapter describes how to set up the digital scanner for OCR programming. The digital scanner can read 6 to 60 point OCR typeface. It supports font types OCR-A, OCR-B, MICR-E13B, and US Currency Serial Number.

OCR is not as secure as a barcode. To decrease OCR misdecodes and speed OCR reading, set an accurate OCR template and character subset, and use a check digit.

All OCR fonts are disabled by default. Enabling OCR can slow barcode decoding. Enabling more than one OCR font could also slow OCR decoding and impact OCR decoding accuracy.

Throughout the programming barcode menus, asterisks (*) indicate default values. OCR Parameter Defaults

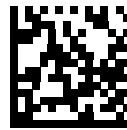

* Indicates Default * **Disable OCR-A** Feature/Option



NOTE: OCR pertains to the DS36X8-HP configuration only.



NOTE: Most computer monitors allow scanning the barcodes directly on the screen. When scanning from the screen, be sure to set the document magnification to a level where you can see the barcode clearly, and bars and/or spaces are not merging.

Table 15 lists the defaults for OCR parameters. To change any option, scan the appropriate barcode(s) provided in the Parameter Descriptions section beginning on [page 267](#).



NOTE: See [Standard Default Parameters](#) for all user preferences, hosts, symbologies, and default parameters.

Table 15 OCR Programming Default Table

Parameter	Parameter Number	SSI Number	Default	Page Number
OCR Programming Parameters				
OCR-A	680	F1h A8h	Disable	267
OCR-A Variant	684	F1h ACh	Full ASCII	268

Table 15 OCR Programming Default Table (Continued)

Parameter	Parameter Number	SSI Number	Default	Page Number
OCR-B	681	F1h A9h	Disable	270
OCR-B Variant	685	F1h ADh	Full ASCII	271
MICR E13B	682	F1h AAh	Disable	275
US Currency	683	F1h ABh	Disable	276
OCR Orientation	687	F1h AFh	0°	276
OCR Lines	691	F1h B3h	1	278
OCR Minimum Characters	689	F1h B1h	3	278
OCR Maximum Characters	690	F1h B2h	100	279
OCR Subset	686	F1h AEh	Selected font variant	279
OCR Quiet Zone	695	F1h B7h	50	280
OCR Template	547	F1h 23h	99999999	281
OCR Check Digit Modulus	688	F1h B0h	1	290
OCR Check Digit Multiplier	700	F1h BCh	121212121212	291
OCR Check Digit Validation	694	F1h B6h	None	293
Inverse OCR	856	F2h 58h	Regular	298
OCR Redundancy	1770	F8h 06h EAh	Level 1	299

OCR Programming Parameters

Enable/Disable OCR-A

Parameter # 680 (SSI # F1h A8h)

To enable or disable OCR-A, scan one of the following barcodes.



NOTE: OCR is not as secure as a barcode. To decrease OCR misdecodes and speed OCR reading, set an accurate OCR template and character subset, and use a check digit. See [OCR Subset on page 279](#) and [OCR Template on page 281](#).



NOTE: All OCR fonts are disabled by default. Enabling OCR can slow barcode decoding. Enabling more than one OCR font could also slow OCR decoding and impact OCR decoding accuracy.



Enable OCR-A
(1)



* Disable OCR-A
(0)

OCR-A Variant

Parameter # 684 (SSI # F1 ACh)

Font variant sets a processing algorithm and default character subset for the given font. To choose a variant, scan one of the following barcodes. Selecting the most appropriate font variant optimizes performance and accuracy.

OCR-A supports the following variants:

- OCR-A Full ASCII
!#\$()*+,-./0123456789<>ABCDEFGHIJKLMNOPQRSTUVWXYZ\^
- OCR-A Reserved 1
\$*+,-./0123456789ABCDEFGHIJKLMNOPQRSTUVWXYZ
- OCR-A Reserved 2
\$*+,-./0123456789<>ABCDEFGHIJKLMNOPQRSTUVWXYZ
- OCR-A Banking
-0123456789<> ƒ ɸ ɦ

Special banking characters output as the following representative characters:

ƒ outputs as f

ɸ outputs as c

ɦ outputs as h



NOTE: Enable OCR-A before setting this parameter. If disabling OCR-A, set the variant to its default (OCR-A Full ASCII).

OCR-A Variant (continued)



* OCR-A Full ASCII
(0)



OCR-A Reserved 1
(1)

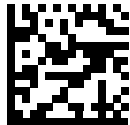

OCR-A Reserved 2
(2)



OCR-A Banking
(3)

Enable/Disable OCR-B

Parameter # 681 (SSI # F1h A9h)

To enable or disable OCR-B, scan one of the following barcodes.



NOTE: OCR is not as secure as a barcode. To decrease OCR misdecodes and speed OCR reading, set an accurate OCR template and character subset, and use a check digit. See [OCR Subset on page 279](#) and [OCR Template on page 281](#).



NOTE: All OCR fonts are disabled by default. Enabling OCR can slow barcode decoding. Enabling more than one OCR font could also slow OCR decoding and impact OCR decoding accuracy.



**Enable OCR-B
(1)**



*** Disable OCR-B
(0)**

OCR-B Variant

Parameter # 685 (SSI # F1h ADh)

OCR-B has the following variants. Selecting the most appropriate font variant affects performance and accuracy.

- OCR-B Full ASCII
!#\$%()*+,-./0123456789<>ABCDEFGHIJKLMNOPQRSTUVWXYZ^|ñ
- OCR-B Banking
#+-0123456789<>JNP|
- OCR-B Limited
+,-./0123456789<>ACENPSTVX
- OCR-B ISBN 10-Digit Book Numbers
-0123456789>BCEINPSXz
- OCR-B ISBN 10 or 13-Digit Book Numbers
-0123456789>BCEINPSXz
- OCR-B Travel Document Version 1 (TD1) 3-Line ID Cards
-0123456789<ABCDEFGHIJKLMNOPQRSTUVWXYZ
- OCR-B Travel Document Version 2 (TD2) 2-Line ID Cards
-0123456789<ABCDEFGHIJKLMNOPQRSTUVWXYZ
- OCR-B Travel Document 2 or 3-Line ID Cards Auto-Detect
!#\$%()*+,-./0123456789<>ABCDEFGHIJKLMNOPQRSTUVWXYZ^|ñ
- OCR-B Passport
-0123456789<ABCDEFGHIJKLMNOPQRSTUVWXYZñ
- OCR-B Visa Type A
-0123456789<ABCDEFGHIJKLMNOPQRSTUVWXYZ
- OCR-B Visa Type B
-0123456789<ABCDEFGHIJKLMNOPQRSTUVWXYZñ
- OCR-B ICAO Travel Documents
This allows reading either TD1, TD2, Passport, Visa Type A, or Visa Type B without switching between these options. It automatically recognizes the travel document read.

To choose a variant, scan one of the following barcodes. Selecting the following OCR-B variants automatically sets the appropriate [OCR Lines on page 278](#). These five variants invoke extensive special algorithms and checking for that particular document type:

VariantOCR Lines Setting

Passport2

TD1 ID Cards3

TD2 ID Cards2

Visa Type A2

Visa Type B2

Selecting one of the ISBN Book Numbers automatically applies the appropriate ISBN checksum, so you do not need to set this.

OCR-B Variant (continued)

For the best performance in passport reading, fix the target passport and the decoder in place (6.5 - 7.5”).



NOTE: Enable OCR-B before setting this parameter. If disabling OCR-B, set the variant to its default (OCR-B Full ASCII).



* OCR-B Full ASCII
(0)



OCR-B Banking
(1)



OCR-B Limited
(2)



OCR-B ISBN 10-Digit Book Numbers
(6)

OCR-B Variant (continued)

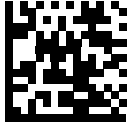

**OCR-B ISBN 10 or 13-Digit Book Numbers
(7)**



**OCR-B Travel Document Version 1 (TD1)
3 Line ID Cards
(3)**



**OCR-B Travel Document Version 2 (TD2)
2-Line ID Cards
(8)**



**Travel Document 2 or 3-Line ID Cards Auto-Detect
(20)**

OCR-B Variant (continued)



**OCR-B Passport
(4)**



**OCR-B Visa Type A
(9)**



**OCR-B Visa Type B
(10)**



**OCR-B ICAO Travel Documents
(11)**

Enable/Disable MICR E13B

Parameter # 682 (SSI # F1h AAh)

To enable or disable MICR E13B, scan one of the following barcodes.

MICR E13B uses the following characters:

0 1 2 3 4 5 6 7 8 9 | : ; ' | " | .

TOAD characters (Transit, On Us, Amount, and Dash) output as the following representative characters:

- |: outputs as t
- '| outputs as a
- || outputs as o
- ||| outputs as d



NOTE: OCR is not as secure as a barcode. To decrease OCR misdecodes and speed OCR reading, set an accurate OCR template and character subset, and use a check digit. See [OCR Subset on page 279](#) and [OCR Template on page 281](#).



NOTE: All OCR fonts are disabled by default. Enabling OCR can slow barcode decoding. Enabling more than one OCR font could also slow OCR decoding and impact OCR decoding accuracy.



Enable MICR E13B
(1)



* Disable MICR E13B
(0)

Enable/Disable US Currency Serial Number

Parameter # 683 (SSI # F1h ABh)

To enable or disable US Currency Serial Number, scan one of the following barcodes.



NOTE: OCR is not as secure as a barcode. To decrease OCR misdecodes and speed OCR reading, set an accurate OCR template and character subset, and use a check digit. See [OCR Subset on page 279](#) and [OCR Template on page 281](#).



NOTE: All OCR fonts are disabled by default. Enabling OCR can slow barcode decoding. Enabling more than one OCR font could also slow OCR decoding and impact OCR decoding accuracy.



**Enable US Currency
(1)**



*** Disable US Currency
(0)**

OCR Orientation

Parameter # 687 (SSI # F1h AFh)

Select one of five options to specify the orientation of an OCR string to be read:

- 0° to the imaging engine (default)
- 270° clockwise (or 90° counterclockwise) to the imaging engine
- 180° (upside down) to the imaging engine
- 90° clockwise to the imaging engine
- Omnidirectional

Setting an incorrect orientation can cause misdecodes.

OCR Orientation (continued)



*** OCR Orientation 0°
(0)**

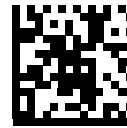

**OCR Orientation 270° Clockwise
(1)**



**OCR Orientation 180° Clockwise
(2)**



**OCR Orientation 90° Clockwise
(3)**



**OCR Orientation Omnidirectional
(4)**

OCR Lines

Parameter # 691 (SSI # F1h B3h)

To select the number of OCR lines to decode, scan one of the following barcodes. Selecting Visas, TD1, or TD2 ID cards automatically sets the appropriate **OCR Lines**. Also see [OCR-B Variant on page 271](#).



* OCR 1 Line
(1)



OCR 2 Lines
(2)



OCR 3 Lines
(3)

OCR Minimum Characters

Parameter # 689 (SSI # F1h B1h)

To select the minimum number of OCR characters (not including spaces) per line to decode, scan the following barcode, then scan a three-digit number between 003 and 100 using the barcodes in [Alphanumeric and Numeric Barcodes](#) representing the number of OCR characters to decode. Strings of OCR characters less than the minimum are ignored. The default is 003.



OCR Minimum Characters

OCR Maximum Characters

Parameter # 690 (SSI # F1h B2h)

To select the maximum number of OCR characters (including spaces) per line to decode, scan the following barcode, then scan a three-digit number between 003 and 100 using the barcodes in [Alphanumeric and Numeric Barcodes](#) representing the number of OCR characters to decode. Strings of OCR characters greater than the maximum are ignored. The default is 100.



OCR Maximum Characters

OCR Subset

Parameter # 686 (SSI # F1h AEh)

Set an OCR subset to define a custom group of characters in place of a preset font variant. For example, if scanning only numbers and the letters A, B, and C, create a subset of just these characters to speed decoding. This applies a designated OCR Subset across all enabled OCR fonts.

To set or modify the OCR font subset, first enable the appropriate OCR font(s). Next, scan the following barcode, then scan numbers and letters to form the OCR Subset from the alphanumeric keyboard in the *Advanced Data Formatting Guide*. Then scan **End of Message** in the *Advanced Data Formatting Guide*.



OCR Subset

To cancel an OCR subset, for OCR-A or OCR-B, set OCR-A variant **Full ASCII**, or OCR-B variant **Full ASCII**, and set subset to **NULL string**.

For MICR E13B or US Currency Serial Number, create a subset which includes all allowed characters in that character set, or scan an option from the [Standard Default Parameters on page 318](#) and re-program the digital scanner.

OCR Quiet Zone

Parameter # 695 (SSI # F1h B7h)

This option sets the OCR quiet zone. The digital scanner stops scanning a field when it detects a sufficiently wide blank space. The width of this space is defined by the End of Field option. Used with parsers that tolerate slanted characters, the End of Field count is roughly a count of 8 for a character width. For example if set to 15, then two character widths are an end of line indicator for the parser. Larger end of field numbers require bigger quiet zones at each end of text line.

To set a quiet zone, scan the following barcode, then scan a two-digit number using the numeric keypad in the *Advanced Data Formatting Guide*. The range of the quiet zone is 20 - 99 and the default is 50, indicating a six character width quiet zone.



OCR Quiet Zone

OCR Template

Parameter # 547 (SSI # F1h 23h)

This option creates a template for precisely matching scanned OCR characters to a desired input format. Carefully constructing an OCR template eliminates scanning errors.

To set or modify the OCR decode template, scan the [OCR Template](#) barcode, then barcodes corresponding to numbers and letters on the following pages to form the template expression. Then scan **End of Message** in the *Advanced Data Formatting Guide*. The default is **99999999** which accepts OCR strings only containing eight digits.



OCR Template



End of Message

Required Digit (9)



9

Only a numeric character is allowed in this position.

Template	Valid data	Valid data	Invalid data
99999	12987	30517	123AB

Required Alpha (A)

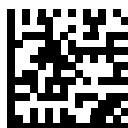

A

Only an alpha character is allowed in this position.

Template	Valid data	Valid data	Invalid data
AAA	ABC	WXY	12F

Optional Alphanumeric (1)



1

When this option appears in the template string, the data validator accepts an alphanumeric character if present. Optional characters are not allowed as the first character(s) in a field of like characters.

Template	Valid data	Valid data	Invalid data
99991	1234A	12345	1234<

Optional Alpha (2)



2

When this option appears in the template string, the data validator accepts an alpha character if present. Optional characters are not allowed as the first character(s) in a field of like characters.

Template	Valid data	Valid data	Invalid data
AAAA2	ABCDE	WXYZ	ABCD6

Alpha or Digit (3)



3

The data validator requires an alphanumeric character in this position to validate the incoming data.

Template	Valid data	Valid data	Invalid data
33333	12ABC	WXY34	12AB<

Any Including Space & Reject (4)



4

The template accepts any character in this position, including space and reject. Rejects are represented as an underscore (_) in the output. This is a good selection for troubleshooting.

Template	Valid data	Valid data
99499	12\$34	34_98

Any except Space & Reject (5)



5

The template accepts any character in this position except a space or reject.

Template	Valid data	Valid data	Invalid data
55999	A.123	*Z456	A BCD

Optional Digit (7)



7

When this option appears in the template string, the template accepts a numeric character if present. Optional characters are not allowed as the first character(s) in a field of like characters.

Template	Valid data	Valid data	Invalid data
99977	12345	789	789AB

Digit or Fill (8)



8

The data validator accepts any numeric or fill character in this position.

Template	Valid data	Valid data	Valid data
88899	12345	>>789	<<789

Alpha or Fill (F)



F

The data validator accepts any alpha or fill character in this position.

Template	Valid data	Valid data	Valid data
AAFF	ABCXY	LMN>>	ABC<5

Optional Space ()



Space

When this option appears in the template string, the template accepts a space if present. Optional characters are not allowed as the first character(s) in a field of like characters.

Template	Valid data	Valid data	Invalid data
99 99	12 34	1234	67891

Optional Small Special (.)



.

When this option appears in the template string, the data validator accepts a special character if present. Optional characters are not allowed as the first character(s) in a field of like characters. Small special characters are - , and .

Template	Valid data	Valid data	Invalid data
AA.99	MN.35	XY98	XYZ12

Other Template Operators

These template operators assist in capturing, delimiting, and formatting scanned OCR data.

Literal String (" and +)



"



+

Use either of these delimiting characters surrounding characters from the alphanumeric keyboard in the *Advanced Data Formatting Guide* to define a literal string within a template that must be present in scanned OCR data. There are two characters used to delimit required literal strings; if one of the delimiter characters is present in the desired literal string, use the other delimiter.

Template	Valid data	Invalid data
"35+BC"	35+BC	AB+22

New Line (E)



E

To create a template of multiple lines, add **E** between the template of each single line.

Template	Valid data	Valid data	Invalid data
999EAAAA	321	987	XYZW
	BCAD	ZXYW	12

String Extract (C)



C

This operator combined with others defines a string of characters to extract from the scanned data. The string extract is structured as follows:

CbPe

Where:

- C is the string extract operator
- b is the string begin delimiter
- P is the category (one or more numeric or alpha characters) describing the string representation
- e is the string end delimiter

Values for b and e can be any scannable character. They are included in the output stream.

Template	Incoming data	Output
C>A>	XQ3>ABCDE>	>ABCDE>
	->ATHRUZ>123	>ATHRUZ>
	1ABCZXYZ	No Output

Ignore to End of Field (D)

D

This operator causes all characters after a template to be ignored. Use this as the last character in a template expression. Examples for the template 999D:

Template	Incoming data	Output
999D	123-PED	123
	357298	357
	193	193

Skip Until (P1)

P



1

This operator allows skipping over characters until a specific character type or a literal string is detected. It can be used in two ways:

P1ct

Where:

- P1 is the Skip Until operator
- c is the type of character that triggers the start of output
- t is one or more template characters

P1"s"t

Where:

- P1 is the Skip Until operator
- "s" is one or more literal string characters (see [Literal String \(" and +\) on page 285](#)) that trigger the start of output

- t is one or more template characters

The trigger character or literal string is included in output from a Skip Until operator, and the first character in the template should accommodate this trigger.

Template	Incoming data	Output
P1"PN"AA9999	123PN9876	PN9876
	PN1234	PN1234
	X-PN3592	PN3592

Skip Until Not (P0)



P



0

This operator allows skipping over characters until a specific character type or a literal string is not matched in the output stream. It can be used in two ways:

P0ct

Where:

- P0 is the Skip Until Not operator
- c is the type of character that triggers the start of output
- t is one or more template characters

P0"s"t

Where:

- P0 is the Skip Until Not operator
- "s" is one or more literal string characters (see [Literal String \(" and +\) on page 285](#)) that trigger the start of output
- t is one or more template characters

The trigger character or literal string is not included in output from a Skip Until Not operator.

Template	Incoming data	Output
POA9999	BPN3456	3456
	PN1234	1234
	5341	No output
P0"PN"9999	PN3456	3456
	5341	No output
	PNPN7654	7654

Repeat Previous (R)



R

This operator allows a template character to repeat one or more times, allowing the capture of variable-length scanned data. The following examples capture two required alpha characters followed by one or more required digits:

Template	Incoming data	Output
AA9R	AB3	AB3
	PN12345	PN12345
	32RM52700	No output

Scroll Until Match (S)



S

This operator steps through scanned data one character at a time until the data matches the template.

Template	Incoming data	Output
S99999	AB3	No Output
	PN12345	12345
	32RM52700	52700

Multiple Templates

This feature sets up multiple templates for OCR decoding. To do this, follow the procedure described in [OCR Template on page 281](#) (scan the [OCR Template](#) barcode, then barcodes corresponding to numbers and letters to form the template expression, then **End of Message**) for each template in the multiple template string, using a capital letter **X** as a separator between the templates.

For example, set the [OCR Template](#) as **99999XAAAAA** to decode OCR strings of either **12345** or **ABCDE**.

Template Examples

Following are sample templates with descriptions of valid data for each definition.

Field Definition Description

"M"99977 **M** followed by three digits and two optional digits.

"X"997777"X" **X** followed by two digits, four optional digits, and an X.

9959775599 Two digits followed by any character, a digit, two optional digits, any two characters, and two digits.

A55"-"999"-"99 A letter followed by two characters, a dash, three digits, a dash, and two digits.

33A"."99 Two alphanumeric characters followed by a letter, a period, and two digits.

999992991Five digits followed by an optional alpha, two digits, and an optional alphanumeric.

"PN98" Literal field - **PN98**

OCR Check Digit Modulus

Parameter # 688 (SSI # F1h B0h)

This option sets OCR module check digit calculation. The check digit is the last digit (in the right most position) in an OCR string and improves the accuracy of the collected data. The check digit is the end product of a calculation made on the incoming data. For check digit calculation, for example Modulus 10, alpha and numeric characters are assigned numeric weights (see [OCR Check Digit Multiplier on page 291](#)). The calculation is applied to the character weights and the resulting check digit is added to the end of the data. If the incoming data does not match the check digit, the data is considered corrupt.

The selected check digit option does not take effect until you set **OCR Check Digit Validation**.

To choose the Check Digit Modulus, such as 10 for modulo 10, scan the following barcode, then scan a three-digit number from 001 to 099 representing the check digit using the numeric keypad in the *Advanced Data Formatting Guide*. The default is 1.



OCR Check Digit

OCR Check Digit Multiplier

Parameter # 700 (SSI # F1h BCh)

This option sets OCR check digit multipliers for the character positions. For check digit validation, each character in scanned data has an equivalent weight used in the check digit calculation. DS36X8 OCR ships with the following weight equivalents:

0 = 0 A = 10 K = 20 U = 30

1 = 1 B = 11 L = 21 V = 31

2 = 2 C = 12 M = 22 W = 32

3 = 3 D = 13 N = 23 X = 33

4 = 4 E = 14 O = 24 Y = 34

5 = 5 F = 15 P = 25 Z = 35

6 = 6 G = 16 Q = 26 Space = 0

7 = 7 H = 17 R = 27

8 = 8 I = 18 S = 28

9 = 9 J = 19 T = 29

All other characters are equivalent to one (1).

You can define the multiplier string if it is different from the default.

121212121212 (default)

123456789A (for ISBN, Product Add Right to Left. See [OCR Check Digit Validation on page 293](#).)

For example:

ISBN 0 2 0 1 1 8 3 9 9 4

Multiplier 10 9 8 7 6 5 4 3 2 1

Product 0 18 0 7 6 40 12 27 18 4

Product add 0+ 18+ 0+ 7+ 6+ 40+ 12+ 27+ 18+ 4= 132

ISBN uses modulo 11 for its check digit. In this case, 132 is divisible by 11, so it passes the check digit.

To set the check digit multiplier, scan the following barcode, then scan numbers and letters to form the multiplier string from the alphanumeric keyboard in the *Advanced Data Formatting Guide*. Then scan **End of Message** in the *Advanced Data Formatting Guide*.

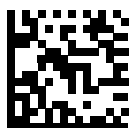

OCR Check Digit Multiplier

OCR Check Digit Validation

Parameter # 694 (SSI # F1h B6h)

Use **OCR Check Digit Validation** to protect against scanning errors by applying a check digit validation scheme. The following is a list of options.

None

No check digit validation, indicating no check digit is applied. This is the default.



* No Check Digit
(0)

Product Add Left to Right

Each character in the scanned data is assigned a numeric value (see [OCR Check Digit Multiplier on page 291](#)). Each digit representing a character in the scanned data is multiplied by its corresponding digit in the multiplier, and the sum of these products is computed. The check digit passes if this sum modulo Check Digit Modulus is zero.

Example:

Scanned data numeric value is 132456 (check digit is 6)

Check digit multiplier string is 123456

Digit 1 3 2 4 5 6

Multiplier 1 2 3 4 5 6

Product 1 6 6 16 25 36

Product add $1+ 6+ 6+ 16+ 25+ 36= 90$

The Check Digit Modulus is 10. It passes because 90 is divisible by 10 (the remainder is zero).



Product Add Left to Right
(3)

Product Add Right to Left

Each character in the scanned data is assigned a numeric value (see [OCR Check Digit Multiplier on page 291](#)). The check digit multiplier is reversed in order. Each value representing a character in the scanned data is

multiplied by its corresponding digit in the reversed multiplier, resulting in a product for each character in the scanned data. The sum of these products is computed. The check digit passes if this sum modulo Check Digit Modulus is zero.

Example:

Scanned data numeric value is 132459 (check digit is 9)

Check digit multiplier string is 123456

Digit 1 3 2 4 5 9

Multiplier 6 5 4 3 2 1

Product 6 15 8 12 10 9

Product add $6+ 15+ 8+ 12+ 10+ 9= 60$

The Check Digit Modulus is 10. It passes because 60 is divisible by 10 (the remainder is 0).



**Product Add Right to Left
(1)**

Digit Add Left to Right

Each character in the scanned data is assigned a numeric value (see [OCR Check Digit Multiplier on page 291](#)). Each value representing a character in the scanned data is multiplied by its corresponding digit in the multiplier, resulting in a product for each character in the scanned data. The sum of each individual digit in all of the products is then calculated. The check digit passes if this sum modulo Check Digit Modulus is zero.

Example:

Scanned data numeric value is 132456 (check digit is 6)

Check digit multiplier string is 123456

Digit 1 3 2 4 5 6

Multiplier 1 2 3 4 5 6

Product 1 6 6 16 25 36

Digit add $1+ 6+ 6+ 1+6+ 2+5+ 3+6= 36$

The Check Digit Modulus is 12. It passes because 36 is divisible by 12 (the remainder is 0).



**Digit Add Left to Right
(4)**

Digit Add Right to Left

Each character in the scanned data is assigned a numeric value (see [OCR Check Digit Multiplier on page 291](#)). The check digit multiplier is reversed in order. Each value representing a character in the scanned data is multiplied by its corresponding digit in the reversed multiplier, resulting in a product for each character in the scanned data. The sum of each individual digit in all of the products is then calculated. The check digit passes if this sum modulo Check Digit Modulus is zero.

Example:

Scanned data numeric value is 132456 (check digit is 6)

Check digit multiplier string is 123456

Digit 1 3 2 4 5 6

Multiplier 6 5 4 3 2 1

Product 6 15 8 12 10 6

Digit add $6+ 1+5+ 8+ 1+2+ 1+0+ 6= 30$

The Check Digit Modulus is 10. It passes because 30 is divisible by 10 (the remainder is 0).



**Digit Add Right to Left
(2)**

Product Add Right to Left Simple Remainder

Each character in the scanned data is assigned a numeric value (see [OCR Check Digit Multiplier on page 291](#)). The check digit multiplier is reversed in order. Each value representing a character in the scanned data is multiplied by its corresponding digit in the reversed multiplier, resulting in a product for each character in the scanned data. The sum of these products **except for the check digit's product** is computed. The check digit passes if this sum modulo Check Digit Modulus is equal to the check digit's product.

Example:

Scanned data numeric value is 122456 (check digit is 6)

Check digit multiplier string is 123456

Digit 1 2 2 4 5 6

Multiplier 6 5 4 3 2 1

Product 6 10 8 12 10 6

Product add $6+ 10+ 8+ 12+ 10= 466$

The Check Digit Modulus is 10. It passes because 46 divided by 10 leaves a remainder of 6.



Product Add Right to Left Simple Remainder (5)

Digit Add Right To Left Simple Remainder

Each character in the scanned data is assigned a numeric value (see [OCR Check Digit Multiplier on page 291](#)). The check digit multiplier is reversed in order. Each value representing a character in the scanned data is multiplied by its corresponding digit in the reversed multiplier, resulting in a product for each character in the scanned data. The sum of each individual digit in all of the products **except for the check digit's product** is then calculated. The check digit passes if this sum modulo Check Digit Modulus is equal to the check digit's product.

Example:

Scanned data numeric value is 122459 (check digit is 6)

Check digit multiplier string is 123456

Digit 1 2 2 4 5 9

Multiplier 6 5 4 3 2 1

Product 6 10 8 12 10 9

Digit add $6+ 1+0+ 8+ 1+2+ 1+0= 199$

The Check Digit Modulus is 10. It passes because 19 divided by 10 leaves a remainder of 9.

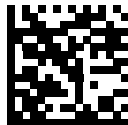

Digit Add Right to Left Simple Remainder (6)

Health Industry - HIBCC43

This is the health industry module 43 check digit standard. The check digit is the modulus 43 sum of all the character values in a given message, and is printed as the last character in a given message.

Example:

Supplier Labeling Data Structure: + A 1 2 3 B J C 5 D 6 E 7 1

Sum of values: $41+10+1+2+3+11+19+12+5+13+6+14+7+1 = 145$

Divide 145 by 43. The quotient is 3 with a remainder of 16. The check digit is the character corresponding to the value of the remainder (see Table 16), which in this example is 16, or **G**. The complete Supplier Labeling Data Structure, including the check digit, therefore is:

A 1 2 3 B J C 5 D 6 E 7 1 G

Table 16 Table of Numeric Value Assignments for Computing HIBC LIC Data Format Check Digit

0 = 0	9 = 9	I = 18	R = 27	- = 36
1 = 1	A = 10	J = 19	S = 28	. = 37
2 = 2	B = 11	K = 20	T = 29	Space = 38
3 = 3	C = 12	L = 21	U = 30	\$ = 39
4 = 4	D = 13	M = 22	V = 31	/ = 40
5 = 5	E = 14	N = 23	W = 32	+ = 41
6 = 6	F = 15	O = 24	X = 33	% = 42
7 = 7	G = 16	P = 25	Y = 34	
8 = 8	H = 17	Q = 26	Z = 35	



Health Industry - HIBCC43
(9)

Inverse OCR

Parameter # 856 (SSI # F2h 58h)

Inverse OCR is white or light words on a black or dark background. Select an option for decoding inverse OCR:

- **Regular Only** - decode regular OCR (black on white) strings only.
- **Inverse Only** - decode inverse OCR (white on black) strings only.
- **Autodiscriminate** - decodes both regular and inverse OCR strings.



* Regular Only
(0)



Inverse Only
(1)



Autodiscriminate
(2)

OCR Redundancy

Parameter # 1770 (SSI # F8h 06h EAh)

This option adjusts the number of times to decode an OCR text string before transmission. There are three levels of OCR decode redundancy. There is an inverse relationship between the redundancy level and OCR decoding aggressiveness. Increasing the level of the redundancy can reduce OCR scanning aggressiveness, so select only the level of redundancy necessary.

- **OCR Redundancy Level 1:** This default setting allows the scanner to operate in its most aggressive state while providing sufficient accuracy in decoding most in-spec OCR text strings.
- **OCR Redundancy Level 2:** This setting eliminates most misdecodes while maintaining reasonable aggressiveness.
- **OCR Redundancy Level 3:** Select this option with greater redundancy requirements if OCR Redundancy Level 2 fails to eliminate misdecodes.

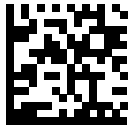

* OCR Redundancy Level 1
(1)



OCR Redundancy Level 2
(2)



OCR Redundancy Level 3
(3)

Maintenance and Troubleshooting

Introduction

This chapter provides suggested RS5100 troubleshooting and maintenance.

Maintenance

Cleaning the scan window is the basic maintenance required. A dirty window can affect scanning performance.

- Do not allow abrasive material to touch the window.
- Remove any dirt particles with a damp cloth.
- Wipe the window using a tissue moistened with ammonia/water.
- Do not spray water or other cleaning liquids directly into the window.

Battery Safety Guidelines

- The area in which the RS5100 units are charged should be clear of debris and combustible materials or chemicals. Particular care should be taken where the device is charged in a non-commercial environment.
- Do not use incompatible batteries and chargers. If you have any questions about the compatibility of a battery or a charger, contact Zebra Support. Go to [Service Information on page 5](#) for contact information.
- Do not crush, puncture, or place a high degree of pressure on the battery.
- Follow battery usage, storage, and charging guidelines.
- Improper battery use may result in a fire, explosion, or other hazard.
- To charge the mobile device battery, the battery and charger temperatures must be between +32°F and +104°F (0°C and +40°C)
- Do not disassemble or open, crush, bend or deform, puncture, or shred.
- Severe impact from dropping any battery-operated device on a hard surface could cause the battery to overheat.
- Do not short circuit a battery or allow metallic or conductive objects to contact the battery terminals.
- Do not modify or remanufacture, attempt to insert foreign objects into the battery, immerse or expose to water or other liquids, or expose to fire, explosion, or other hazard.
- Do not leave or store the equipment in or near areas that might get very hot, such as in a parked vehicle or near a radiator or other heat source. Do not place battery into a microwave oven or dryer.

- Battery usage by children should be supervised.
- Please follow local regulations to promptly dispose of used re-chargeable batteries.
- Do not dispose of batteries in fire.
- Seek medical advice immediately if a battery has been swallowed.
- In the event of a battery leak, do not allow the liquid to come in contact with the skin or eyes. If contact has been made, wash the affected area with large amounts of water and seek medical advice.
- If you suspect damage to your equipment or battery, call Customer Support to arrange for inspection. Go to [Service Information on page 5](#) for contact information.

Long Term Storage

When storing the RS5100 for a long period of time, it is recommended to remove the battery. When returning the RS5100 to everyday operation, install a fully charged battery.

Cleaning Instructions



CAUTION: Always wear eye protection.

Read warning label on compressed air and alcohol product before using.

If you have to use any other solution for medical reasons please contact Zebra for more information.



WARNING: Avoid exposing this product to contact with hot oil or other flammable liquids. If such exposure occurs, unplug the device and clean the product immediately in accordance with these guidelines.

Approved Cleanser Active Ingredients

100% of the active ingredients in any cleaner must consist of one or some combination of the following: isopropyl alcohol, or mild dish soap.

Harmful Ingredients

The following chemicals are known to damage the plastics on the device and should not come in contact with the device: ammonia solutions, compounds of amines or ammonia; acetone; ketones; ethers; aromatic and chlorinated hydrocarbons; aqueous or alcoholic alkaline solutions; ethanolamine; toluene; trichloroethylene; benzene; carbolic acid, TB-lysoform, bleach products and hydrogen peroxide.

Cleaning Instructions

Do not apply liquid directly to the device. Dampen a soft cloth or use pre-moistened wipes. Do not wrap the device in the cloth or wipe, but gently wipe the unit. Be careful not to let liquid pool around the display window or other places. Allow the unit to air dry before use.

Special Cleaning Notes

Many vinyl gloves contain phthalate additives, which are often not recommended for medical use and are known to be harmful to the housing of the device. The device should not be handled while wearing vinyl gloves containing phthalates, or before hands are washed to remove contaminant residue after gloves are removed. If products

containing any of the harmful ingredients listed above are used prior to handling the device, such as hand sanitizer that contain ethanalamine, hands must be completely dry before handling the device to prevent damage to the plastics.

Cleaning Materials Required

- Alcohol wipes
- Lens tissue
- Cotton tipped applicators
- Isopropyl alcohol
- Can of compressed air with a tube.

Cleaning Frequency

The cleaning frequency is up to the customer's discretion due to the varied environments in which the WT6000 units are used. They may be cleaned as frequently as required. However when used in dirty environments it may be advisable to periodically clean the scanner exit window to ensure optimum scanning performance.

Cleaning the RS5100

Housing

Using alcohol wipes, wipe the housing.

Exit Window

Wipe the exit window periodically with a lens tissue or other material suitable for cleaning eyeglasses.



CAUTION: Do not pour, spray, or spill any liquid on the RS5100.

Power Connector

1. Remove the battery from RS5100.
2. Dip the cotton portion of the cotton tipped applicator in isopropyl alcohol.
3. Rub the cotton portion of the cotton tipped applicator back-and-forth across the battery connector inside the battery compartment and the I/O connector on the top side of the RS5100. Do not leave any cotton residue on the connectors.
4. Repeat at least three times.
5. Use the cotton tipped applicator dipped in alcohol to remove any grease and dirt near the connector area.
6. Use a dry cotton tipped applicator and repeat steps 3 through 5.
7. Spray compressed air on the connector area by pointing the tube/nozzle about ½ inch away from the surface.



CAUTION: Do not point nozzle at yourself and others, ensure the nozzle or tube is away from your face.

8. Inspect the area for any grease or dirt, repeat if required.

Cleaning Cradle Connectors

Use this procedure to clean the connectors on a cradle:

1. Remove power from the cradle.
2. Dip the cotton portion of the cotton tipped applicator in isopropyl alcohol.
3. Rub the cotton portion of the cotton tipped applicator along the pins of the connector. Slowly move the applicator back-and-forth from one side of the connector to the other. Do not let any cotton residue on the connector.
4. All sides of the connector should also be rubbed with the cotton tipped applicator.
5. Spray compressed air in the connector area by pointing the tube/nozzle about ½ inch away from the surface.



CAUTION: Do not pour, spray, or spill any liquid on the RS5100.

6. Ensure that there is no lint left by the cotton tipped applicator, remove lint if found.
7. If grease and other dirt can be found on other areas of the cradle, use lint free cloth and alcohol to remove.
8. Allow at least 10 to 30 minutes (depending on ambient temperature and humidity) for the alcohol to air dry before applying power to cradle.

If the temperature is low and humidity is high, longer drying time is required. Warm temperature and dry humidity requires less drying time.

Cleaning the Finger Strap and Comfort Pad

It may be necessary to wash the finger strap and comfort pad when they become soiled.

Remove the strap and comfort pads. See [Finger Strap Replacement](#) and [Comfort Pad Replacement](#). Hand wash in cold water with dish soap. Do not use bleach. Air dry. Do not use a hand dryer. Leave the comfort pad to air dry in a shaded area.

Comfort Pad Replacement

To replace the Comfort Pad:

1. Slide the strap out of the buckle.
2. Remove the Comfort Pad from the RS5100.

Figure 88 Removal of Comfort Pad

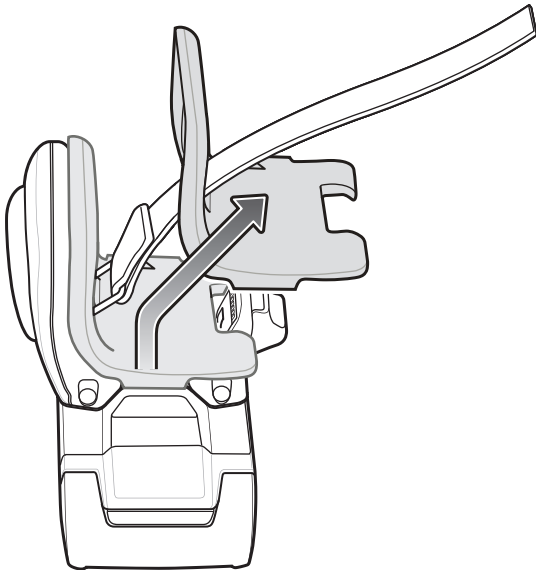

3. Position the Comfort Pad onto the RS5100 as shown.
4. Press the Comfort Pad onto the RS5100. When properly installed, the Comfort Pad locks into place.

Figure 89 Installation of Comfort Pad

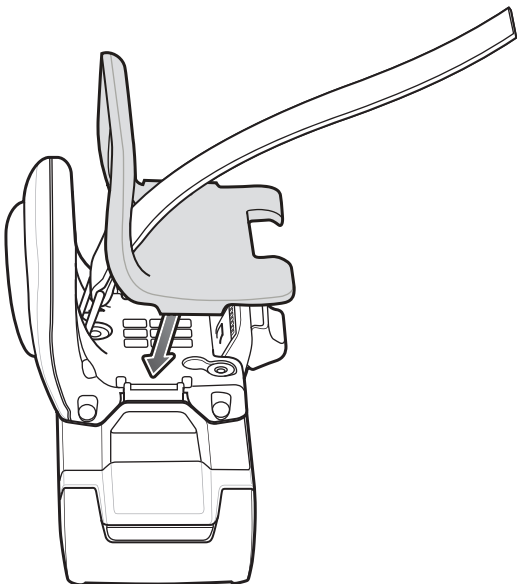

Trigger Assembly Replacement

To replace the Single Trigger or Double Trigger Assembly:



NOTE: After installing a different type of trigger, reboot the RS5100 to recognize the new trigger.

1. Push the Trigger Assembly latch in, while lifting the Trigger Assembly away from the RS5100.

Figure 90 Push Trigger Assembly Latch In and Lift

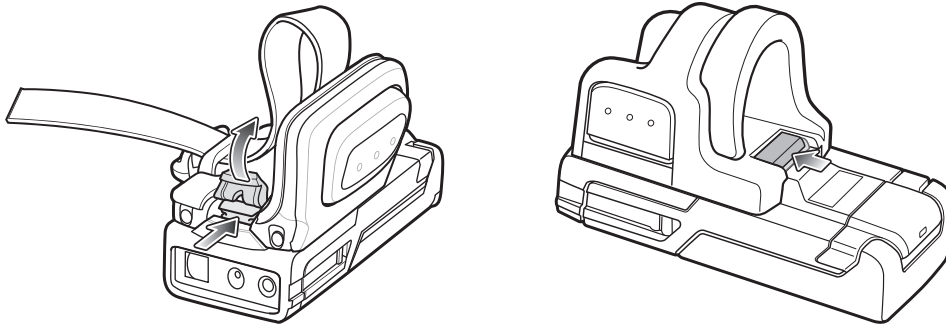

2. Lift the Trigger Assembly off of the RS5100.

Figure 91 Lift Trigger Assembly Off RS5100

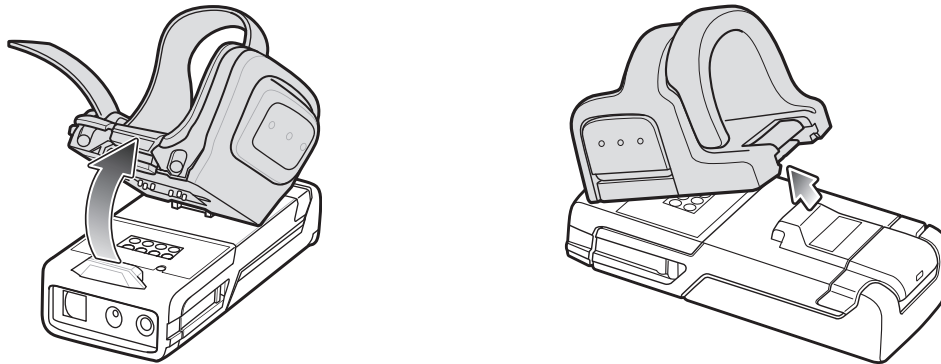

3. Position the Trigger Assembly to align with the back of the RS5100.

Figure 92 Align Trigger Assembly

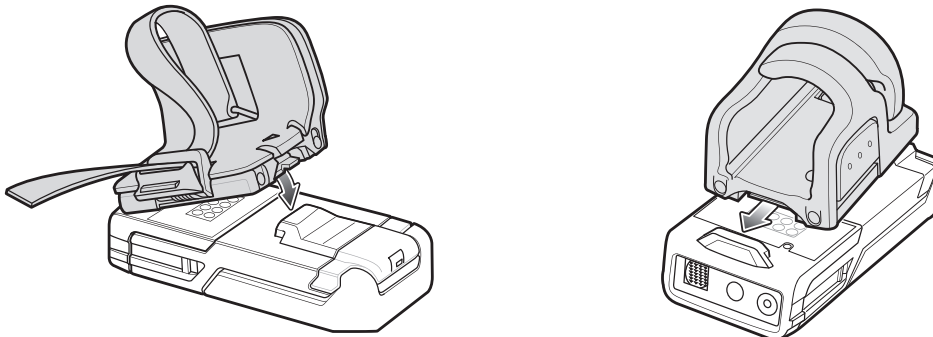

4. Lower the Trigger Assembly onto the housing and snap into place.

Figure 93 Lower Trigger Assembly

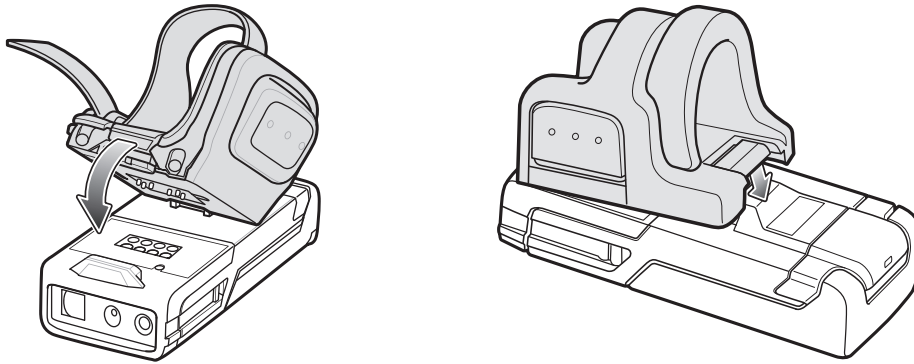

Finger Strap Replacement

To replace the finger strap:

1. Use finger tip to press the strap release latch on the buckle.
2. Remove the Finger Strap from the buckle.
3. Push the Strap Pin in and pull the Finger Strap to remove the Strap Pin out of the Trigger Assembly.

Figure 94 Remove Finger Strap from Trigger Assembly

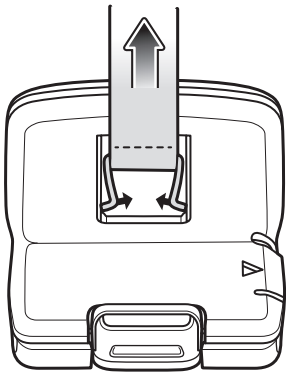

4. Align the Strap Pin of a new Finger Strap with the slot in the Trigger Swivel Assembly.

Figure 95 Finger Strap Pin Replacement

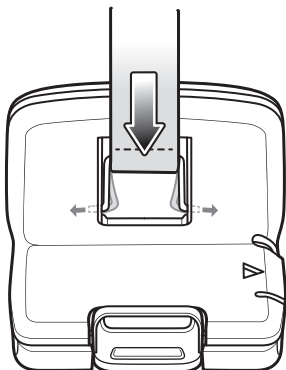

5. Guide the Strap Pin into the slots of the Trigger Swivel Assembly.

6. Pull up on the strap to snap the Strap Pin into the slots.
7. Slide the other end of the strap into the buckle.
8. Press the cam buckle closed.

Troubleshooting

RS5100

Table 17 RS5100 Troubleshooting

Problem	Cause	Solution
Laser aiming pattern does not display when pressing the Scan Trigger.	Battery is not charged.	Replace or charge battery.
	Power is not applied to RS5100.	Replace or charge RS5100 battery.
	Scan application on the mobile computer is not functioning.	Restart the scanning application on the mobile computer.
	RS5100 does not respond.	Reset the RS5100 (Go to Resetting the RS5100 on page 21).
RS5100 does not decode a barcode.	Barcode is unreadable.	Verify that the barcode is not defective, i.e., smudged or damaged.
	Exit window is dirty.	Clean exit window with a lens tissue. Tissues for eyeglasses work well. Do not use tissues coated with lotion (Go to Cleaning the RS5100 on page 302).
	Barcode symbology is not supported or enabled.	See your system administrator.
	Bluetooth link is disconnected.	Reestablish Bluetooth connection (Go to Reconnecting on page 68).
Scanner loses connection to the host device after firmware update	A firmware update caused the scanner to disconnect from the host.	Manually scan a pairing barcode to reconnect to the host device.



NOTE: If after performing these checks the RS5100 still experiences problems, contact the distributor or call Zebra Support. For more information about support, go to [Service Information on page 5](#).

Cradles

Table 18 RS5100 Troubleshooting

Problem	Cause	Solution
Device battery is not charging.	Device was removed from cradle or cradle was unplugged from AC power.	Ensure cradle is receiving power. Ensure device is seated correctly. Confirm main battery is charging. The battery fully charges in approximately four hours.
	Battery is faulty.	Verify that other batteries charge properly. If so, replace the faulty battery (see Figure 7 on page 16).
	The device is not fully seated in the cradle.	Remove and re-insert the device into the cradle, ensuring it is firmly seated.
	Ambient temperature of the cradle is too warm or too cold.	Move the cradle to an area where the ambient temperature is between 5 °C and 40 °C (41 °F and 105 °F).



NOTE: If after performing these checks the RS5100 still experiences problems, contact the distributor or call Zebra Support. For more information about support, go to [Service Information on page 5](#).

Specifications

RS5100 Technical Specifications

The following tables summarize the RS5100's intended operating environment and general technical hardware specifications.

Table 19 RS5100 Technical Specifications

Item	Description
Physical Characteristics	
Dimensions (H x W x L):	61 mm (2.67 in.) x 28 mm (1.10 in.) x 21 mm (0.83 in.)
Weight:	70 g / 2.47 oz
Power	480 mAh standard capacity; 735 mAh extended; PowerPrecision+; Li-Ion Battery Pack
Performance Characteristics	
Optical Resolution:	1280 x 960 pixels
Roll:	360°
Pitch Angle:	± 60° from normal
Skew Tolerance:	± 60° from normal
Aiming Element:	SE4710: 610 nm LED SE4770: 655 nm Laser
Illumination Element	SE4710: 1 Hyper Red 660 nm LED SE4770: 1 Hyper Red 660 nm LED or 1 Warm-White LED
Field of View:	SE4710: Horizontal: 42°, Vertical: 28° SE4770: Horizontal: 48°, Vertical: 30°
SE4710 Typical Working Distance	See Decode Distances on page 317 .
SE4770 Typical Working Distance	See Decode Distances on page 317 .

Specifications

Table 19 RS5100 Technical Specifications (Continued)

Item	Description
Ambient Light Immunity (from total darkness):	Max 107,639 lux (direct sunlight)
Supported 1D Symbologies	Code 39, Code 128, Code 93, Codebar/NW7, Code 11, MSI, UPC/EAN, I 2 of 5, Korean 3 of 5, GSI DataBar, Base 32 (Italian Pharma).
Supported 2D Symbologies	PDF417, MicroPDF417, Composite Codes, TLC-39, Aztec, DataMatrix, MaxiCode, QR Code, Micro QR, Chinese Sensible (Han Xin), Postal Codes.
Supported OCR Symbologies	OCR-A, OCR-B
User Interface	
LED:	4 RGB LEDs located at the back side of the device (programmable).
Beeper:	Up to 85 dBA at 10 cm from the back of the device beeper port.
Restore Key:	User accessible for emergency warm boot and Bluetooth reconnect (after disconnect timeout).
Scan Triggering:	Manual ambidextrous trigger.
User Environment	
Operating Temperature:	-20°C (-4°F) to +50°C (+122°F) (operation with extended battery).
Storage Temperature:	-40°C (-40°F) to +60°C (+140°F) including battery -40°C (-40°F) to +70°C (+158°F) excluding battery
Humidity	5% to 95% (non-condensing).
Drop Specification:	6 ft./1.8 m multiple drops to concrete across operating temperature range.
Tumble Specification	1,000 tumbles @ 0.5 m/1.64 ft.
Sealing	IEC 60529: IP65
Vibration	Sine 5-2000 Hz, 4g peak, one hour per axis Random 20-2000 Hz, 6g RMS or 0.04g2/Hz, one hour per axis
Pairing	NFC; Tap to Pair
Electrostatic Discharge (ESD):	+/-15 kVdc air discharge +/-8 kVdc contact discharge
Data Capture	
Scanning Options	SE4710 or SE4770 standard range imaging engines.
Peripherals and Accessories	
Ring charger:	4-Slot RS5100 Charge Only Cradle 20-Slot RS5100 Charge Only Cradle
Battery charger:	8-Slot Battery Charger 40-Slot Battery Charger

Table 19 RS5100 Technical Specifications (Continued)

Item	Description
Other:	Back of hand mount, lanyard, spare trigger mounts (Not all accessories available during initial release).
Wireless PAN	
Bluetooth	Class 1 and 2, Bluetooth v4.0 with Bluetooth Low Energy (BLE) Supporting profiles: Serial Port Profile (SPP), Human Interface Device Profile (HID), Service Discovery Application Profile (SDAP).
Regulatory	
Environmental Compliance:	RoHS Directive 2011/65/EU; Amendment 2015/863 REACH SVHC 1907/2006

Charger Technical Specifications

2-Bay Charge Only Charger Technical Specifications

Table 20 2-Bay Charge Only Charger Technical Specifications

Item	Description
Dimensions	Height: 180 mm (7.09 in.) Width: 48 mm (1.89 in.) Depth: 19 mm (0.75 in.)
Weight	96 g (3.39 oz)
Input Voltage	5 VDC, 1 A
Operating Temperature	-20°C to 50°C (-4°F to 122°F)
Storage Temperature	-40°C to 70°C (-40°F to 158°F)
Charging Temperature	5°C to 40°C (41°F to 104°F)
Humidity	5 to 95% non-condensing
Drop	75 cm (30 in.) drops to concrete at room temperature.
Electrostatic Discharge (ESD)	+/- 15 kV air discharge +/- 8 kV contact discharge

4-Slot Charge Only Cradle Technical Specifications

Table 21 4-Slot Charge Only Cradle Technical Specifications

Item	Description
Dimensions	Height: 87.97 mm (3.46 in.) Width: 97.52 mm (3.84 in.) Depth: 136.25 mm (5.36 in.)
Weight	433 g (15.27 oz)
Input Voltage	12 VDC
Power Consumption	50 watts
Operating Temperature	5°C to 40°C (41°F to 105°F)
Storage Temperature	-40°C to 70°C (-40°F to 158°F)
Charging Temperature	10°C to 40°C (50°F to 104°F)
Humidity	5% to 95% non-condensing

Table 21 4-Slot Charge Only Cradle Technical Specifications (Continued)

Item	Description
Drop	75 cm (30 in.) drops to concrete at room temperature.
Electrostatic Discharge (ESD)	+/- 15 kV air discharge +/- 8 kV contact discharge

8-Slot Battery Charger Technical Specifications

Table 22 8-Slot Battery Charger Technical Specifications

Item	Description
Dimensions	Height: 83.64 mm (3.29 in.) Width: 97.52 mm (3.84 in.) Depth: 137.29 mm (5.4 in.)
Weight	486 g (17.14 oz)
Input Voltage	12 VDC
Power Consumption	50 watts
Operating Temperature	5°C to 40°C (41°F to 105°F)
Storage Temperature	-40°C to 70°C (-40°F to 158°F)
Charging Temperature	10°C to 40°C (50°F to 104°F)
Humidity	5% to 95% non-condensing
Drop	75 cm (30 in.) drops to concrete at room temperature.
Electrostatic Discharge (ESD)	+/- 15 kV air discharge +/- 8 kV contact discharge

20-Slot Battery Charger Technical Specifications

Table 23 20-Slot Battery Charger Technical Specifications

Item	Description
Dimensions	Height: 523 mm (20.59 in.) Width: 221 mm (8.7 in.) Depth: 131 mm (5.16 in.)
Weight	2,660 g (93.3 oz)
Input Voltage	12 VDC
Power Consumption	50 watts
Operating Temperature	0°C to 50°C (32°F to 122°F)

Specifications

Item	Description
Storage Temperature	-40°C to 70°C (-40°F to 158°F)
Charging Temperature	0°C to 40°C (32°F to 104°F)
Humidity	5% to 95% non-condensing
Drop	75 cm (30 in.) drops to concrete at room temperature.
Electrostatic Discharge (ESD)	+/- 15 kV air discharge +/- 8 kV contact discharge

40-Slot Battery Charger Technical Specifications

Table 24 40-Slot Battery Charger Technical Specifications

Item	Description
Dimensions	Height: 540 mm (21.26 in.) Width: 150 mm (5.91 in.) Depth: 190 mm (7.24 in.)
Weight	3200 g (7.15 oz)
Input Voltage	12 VDC
Power Consumption	50 watts
Operating Temperature	5°C to 40°C (41°F to 158°F)
Storage Temperature	-40°C to 70°C (-40°F to 158°F)
Charging Temperature	0°C to 40°C (32°F to 104°F)
Humidity	5 to 95% non-condensing
Drop	75 cm (30 in.) drops to concrete at room temperature.
Electrostatic Discharge	+/- 20 kV air discharge +/- 10 kV contact discharge

Bluetooth Adapter Technical Specifications

Table 25 Bluetooth Adapter Technical Specifications

Item	Description
Dimensions	Height: 113 mm (4.45 in.) Width: 60.1 mm (2.37 in.) Depth: 31 mm (1.22 in.)
Weight	98 g (3.46 oz)
Input Power Requirements	5 VDC, 200 mA
Operating Temperature	-20 °C to 50°C (-4°F to 122°F)
Storage Temperature	-40°C to 70°C (-40°F to 158°F)
Humidity	5% to 95% non-condensing
Drop	75 cm (30 in.) drops to concrete at room temperature.
Electrostatic Discharge (ESD)	+/- 15 kV air discharge +/- 8 kV contact discharge

Decode Distances

Table 26 Decode Distances

Barcode Type	Symbol Density	SE4710 Typical Working Ranges		SE4770 Typical Working Ranges	
		Near	Far	Near	Far
Code 39	3 mil	N/A	N/A	7.6 cm./3.0 in.	14.7 cm./5.8 in.
	4 mil	8.4 cm./3.3 in.	22.4 cm./8.8 in.	N/A	N/A
	5 mil	5.08 cm./2.0 in.	34.3 cm./13.5 in.	N/A	N/A
	20 mil	5.08 cm./2.0 in. Field of view limited	76.2 cm./30.0 in.	4.1 cm./1.6 in.	91.7 cm./36.1 in.
Code 128	5 mil	7.1 cm./2.8 in.	20.8 cm/8.2 in.	5.8 cm./2.3 in.	24.9 cm./9.8 in.
	15 mil	N/A	N/A	6.1 cm./2.4 in.	70.6 cm./27.8 in.
PDF 417	5 mil	7.9 cm./3.1 in.	21.3 cm./8.4 in.	7.6 cm./3.0 in.	20.1 cm./7.9 in.
	6.67 mil	N/A	N/A	6.4 cm./2.5 in.	25.7 cm./10.1 in.
DataMatrix	10 mil	7.4 cm./2.9 in.	25.7 cm./10.1 in.	5.3 cm./2.1 in.	27.9 cm./11.0 in.
100% UPCA		4.6 cm./1.8 in. Field of view limited	66.0 cm./26.0 in.	4.1 cm./1.6 in.	63.2 cm./24.9 in.
QR	20 mil	N/A	N/A	2.8 cm./1.1 in.	44.5 cm./17.5 in.

Standard Default Parameters

Standard Default Parameters Table

Table 27 Standard Default Parameters Table

Parameter	Parameter Number	Default	Page Number
Bluetooth Communications			
Bluetooth Communications Host Types		SSI Bluetooth Classic	
Discoverable Mode	610	General	61
Wi-Fi Friendly Mode		Disable	64
Wi-Fi Friendly Channel Exclusion		Use All Channels	65
Radio Output Power	1324	Class 2	66
Link Supervision Timeout	1698	2 Seconds	67
HID Features for Apple iOS	1114	Disable	33
HID Keyboard Keystroke Delay		No Delay (0 msec)	33
CAPS Lock Override		Disable	35
Ignore Unknown Characters		Enable	35
Emulate Keypad		Disable	36
Fast HID Keyboard	1361	Enable	37
Quick Keypad Emulation	1362	Enable	38
Keyboard FN1 Substitution		Disable	38
Function Key Mapping		Disable	39
Simulated Caps Lock		Disable	39
Convert Case		No Case Conversion	40
Beep on Reconnect Attempt	559	Disable	69
Reconnect Attempt Interval	558	30 sec	69

Standard Default Parameters

Table 27 Standard Default Parameters Table (Continued)

Parameter	Parameter Number	Default	Page Number
Auto-reconnect	604	Auto-reconnect Immediately	70
Beep on Insertion	288	Enable	124
Beep on <BEL>	150	Enable	56
Toggle Pairing	1322	Disable	71
Force Pairing Save	795	Enable	72
Auto Un-Pairing	1708	Disable	72
Batch Mode	544	Normal (Do Not Batch Data)	74
PIN Code (Set and Store)	552	12345	62
Variable Pin Code	608	Static (Default PIN code is 12345)	63
Bluetooth Security Levels	1393	Low	63
User Preferences			
Set Default Parameter		Set Defaults	122
Parameter Barcode Scanning	ECh	Enabled	123
Beep After Good Decode	38h	Enabled	124
Beep on Insertion	288	Enabled	124
Beeper Tone	91h	High	126
Beeper Volume	8Ch	High	125
Beeper Duration	F1 74h	Medium	127
Suppress Power Up Beeps	721	Do Not Suppress	127
Low Battery Indication	779	Enable	128
Hand-Held Trigger Mode	138	Level	129
Hand-Held Decode Aiming Pattern	306	Enable	130
Picklist Mode	402	Disabled Always	131
Continuous Barcode Read	649	Disable	132
Unique Barcode Reporting	723	Enable	133
Decode Session Timeout	136	9.9 Sec	134
Timeout Between Decodes, Same Symbol	137	0.5 Sec	135
Timeout Between Decodes, Different Symbols	144	0.1 sec	136

Standard Default Parameters

Table 27 Standard Default Parameters Table (Continued)

Parameter	Parameter Number	Default	Page Number
Fuzzy 1D Processing	514	Enable	136
Decode Mirror Images (Data Matrix Only)	537	Auto	137
Mobile Phone/Display Mode	716	Normal	138
PDF Prioritization	719	Disable	139
PDF Prioritization Timeout	720	200 ms	140
Decoding Illumination	298	Enable	141
Motion Tolerance	858	Less Motion Tolerance	142
Miscellaneous Options			
Add an Enter Key	N/A	N/A	142
Transmit Code ID Character	45	None	142
Prefix Value	99, 105	7013 <CR><LF>	143
Suffix 1 Value Suffix 2 Value	98, 104 100, 106	7013 <CR><LF>	143
Scan Data Transmission Format	235	Data as is	144
FN1 Substitution Values	103, 109	7013 <CR><LF>	146
Transmit "No Read" Message	94	Disable	147
Picklist Mode	F0h 92h	Disabled	131
Fuzzy 1D Processing	F1h 02h	Enabled	136
Decoding Illumination	F0h, 2Ah	Enabled	141
Symbologies			
Enable/Disable All Code Types			158
UPC/EAN			
UPC-A	1	Enable	159
UPC-E	2	Enable	159
UPC-E1	12	Disable	160
EAN-8/JAN 8	4	Enable	160
EAN-13/JAN 13	3	Enable	161
Bookland EAN	83	Disable	161
Decode UPC/EAN/JAN Supplementals (2 and 5 digits)	16	Ignore	162

Standard Default Parameters

Table 27 Standard Default Parameters Table (Continued)

Parameter	Parameter Number	Default	Page Number
User-Programmable Supplementals		000	165
Supplemental 1:	579		
Supplemental 2:	580		
UPC/EAN/JAN Supplemental Redundancy	80	10	165
Decode UPC/EAN/JAN Supplemental AIM ID	672	Combined	166
UPC Reduced Quiet Zone	1289	Disable	167
Transmit UPC-A Check Digit	40	Enable	167
Transmit UPC-E Check Digit	41	Enable	168
Transmit UPC-E1 Check Digit	42	Enable	168
UPC-A Preamble	34	System Character	169
UPC-E Preamble	35	System Character	170
UPC-E1 Preamble	36	System Character	171
Convert UPC-E to A	37	Disable	172
Convert UPC-E1 to A	38	Disable	172
EAN-8/JAN-8 Extend	39	Disable	173
Bookland ISBN Format	576	ISBN-10	174
UCC Coupon Extended Code	85	Disable	175
Coupon Report	730	New Coupon Format	176
ISSN EAN	617	Disable	177
Code 128			
Code 128	8	Enable	178
Set Length(s) for Code 128	209, 210	1 to 55	179
GS1-128 (formerly UCC/EAN-128)	14	Enable	181
ISBT 128	84	Enable	181
ISBT Concatenation	577	Autodiscriminate	182
Check ISBT Table	578	Enable	183
ISBT Concatenation Redundancy	223	10	183
Code 128 Security Level	751	Security Level 1	184
Code 128 Reduced Quiet Zone	1208	Disable	185

Standard Default Parameters

Table 27 Standard Default Parameters Table (Continued)

Parameter	Parameter Number	Default	Page Number
Ignore Code 128 <FNC4>	1254	Disable	185
Code 128 Exclusive	Param 673	Disable	186
Code 39			
Code 39	0	Enable	187
Trioptic Code 39	13	Disable	187
Convert Code 39 to Code 32 (Italian Pharmacy Code)	86	Disable	188
Code 32 Prefix	231	Disable	189
Set Length(s) for Code 39	18, 19	1 to 55	190
Code 39 Check Digit Verification	48	Disable	191
Transmit Code 39 Check Digit	43	Disable	191
Code 39 Full ASCII Conversion	17	Disable	192
Code 39 Security Level	750	Security Level 1	193
Code 39 Reduced Quiet Zone	1209	Disable	194
Code 39 Buffering - Scan and Store	113	Disable	194
Code 93			
Code 93	9	Enable	197
Set Length(s) for Code 93	26, 27	1 to 55	197
Code 11			
Code 11	10	Disable	199
Set Lengths for Code 11	28, 29	4 to 55	199
Code 11 Check Digit Verification	52	Disable	201
Transmit Code 11 Check Digit(s)	47	Disable	202
Interleaved 2 of 5 (ITF)			
Interleaved 2 of 5 (ITF)	6	Disable	203
Set Lengths for I 2 of 5	22, 23	6 to 55	204
I 2 of 5 Check Digit Verification	49	Disable	206
Transmit I 2 of 5 Check Digit	44	Disable	207
Convert I 2 of 5 to EAN 13	82	Disable	207

Standard Default Parameters

Table 27 Standard Default Parameters Table (Continued)

Parameter	Parameter Number	Default	Page Number
I 2 of 5 Security Level	1121	Security Level 1	208
I 2 of 5 Reduced Quiet Zone	1210	Disable	209
Discrete 2 of 5 (DTF)			
Discrete 2 of 5	5	Disable	210
Set Length(s) for D 2 of 5	20, 21	1 to 55	211
Codabar (NW - 7)			
Codabar	7	Enable	213
Set Lengths for Codabar	24, 25	4 to 55	213
CLSI Editing	54	Disable	215
NOTIS Editing	55	Disable	215
Codabar Upper or Lower Case Start/ Stop Characters Detection	855	Upper Case	216
MSI			
MSI	11	Disable	217
Set Length(s) for MSI	30, 31	4 to 55	217
MSI Check Digits	50	One	219
Transmit MSI Check Digit	46	Disable	219
MSI Check Digit Algorithm	51	Mod 10/Mod 10	221
Chinese 2 of 5			
Chinese 2 of 5	408	Disable	222
Matrix 2 of 5			
Matrix 2 of 5	618	Disable	223
Matrix 2 of 5 Lengths	619 620	4 to 55	223
Matrix 2 of 5 Check Digit	622	Disable	225
Transmit Matrix 2 of 5 Check Digit	623	Disable	225
Korean 3 of 5			
Korean 3 of 5	581	Disable	226
Inverse 1D	586	Regular	227

Standard Default Parameters

Table 27 Standard Default Parameters Table (Continued)

Parameter	Parameter Number	Default	Page Number
GS1 DataBar			
GS1 DataBar-14	338	Enable	228
GS1 DataBar Limited	339	Enable	228
GS1 DataBar Expanded	340	Enable	229
Convert GS1 DataBar to UPC/EAN	397	Disable	229
GS1 DataBar Limited Security Level	728	Level 3	230
Composite			
Composite CC-C	341	Disable	231
Composite CC-A/B	342	Disable	231
Composite TLC-39	371	Disable	232
UPC Composite Mode	344	UPC Never Linked	233
Composite Beep Mode	398	Beep As Each Code Type is Decoded	234
GS1-128 Emulation Mode for UCC/EAN Composite Codes	427	Disable	234
2D Symbolgies			
PDF417	15	Enable	235
MicroPDF417	227	Disable	235
Code 128 Emulation	123	Disable	236
Data Matrix	292	Enable	237
GS1 Data Matrix	1336	Disable	237
Data Matrix Inverse	588	Inverse Autodetect	238
Maxicode	294	Disable	238
QR Code	293	Enable	239
GS1 QR	1343	Disable	239
MicroQR	573	Enable	240
Aztec	574	Enable	240
Aztec Inverse	589	Inverse Autodetect	240
Han Xin	1167	Disable	241
Han Xin Inverse	1168	Regular	241

Table 27 Standard Default Parameters Table (Continued)

Parameter	Parameter Number	Default	Page Number
Postal Codes			
US Postnet	89	Disable	247
US Planet	90	Disable	247
Transmit US Postal Check Digit	95	Enable	248
UK Postal	91	Disable	248
Transmit UK Postal Check Digit	96	Enable	249
Japan Postal	290	Disable	249
Australia Post	291	Disable	250
Australia Post Format	718	Autodiscriminate	251
Netherlands KIX Code	326	Disable	252
USPS 4CB/One Code/Intelligent Mail	592	Disable	252
UPU FICS Postal	611	Disable	253
Mailmark	1337	Disable	253
Canada Post	92	Disable	254
Posti LAPA 4-State Code	2031	Disable	254
Symbology-Specific Security Levels			
Redundancy Level	78	1	255
Security Level	77	1	257
1D Quiet Zone Level	1288	1	258
Intercharacter Gap Size	381	Normal	259
Report Version			259
Macro PDF			
Flush Macro PDF Buffer	N/A	N/A	260
Abort Macro PDF Entry	N/A	N/A	260
Digimarc Barcode			
Digimarc Digital Watermarks	1687	Disable	262
OCR Programming Parameters			
OCR-A	680	Disable	267
OCR-A Variant	684	Full ASCII	268

Standard Default Parameters

Table 27 Standard Default Parameters Table (Continued)

Parameter	Parameter Number	Default	Page Number
OCR-B	681	Disable	270
OCR-B Variant	685	Full ASCII	271
MICR E13B	682	Disable	275
US Currency	683	Disable	276
OCR Orientation	687	0°	276
OCR Lines	691	1	278
OCR Minimum Characters	689	3	278
OCR Maximum Characters	690	100	279
OCR Subset	686	Selected font variant	279
OCR Quiet Zone	695	50	280
OCR Template	547	54R	281
OCR Check Digit Modulus	688	1	290
OCR Check Digit Multiplier	700	121212121212	291
OCR Check Digit Validation	694	None	293
Inverse OCR	856	Regular	298

Programming Reference

Symbol Code Identifiers

Table 28 Symbol Code Characters

Code Character	Code Type
A	UPC-A, UPC-E, UPC-E1, EAN-8, EAN-13
B	Code 39, Code 32
C	Codabar
D	Code 128
E	Code 93
F	Interleaved 2 of 5
G	Discrete 2 of 5, or Discrete 2 of 5 IATA
H	Code 11
J	MSI
K	GS1-128
L	Bookland EAN
M	Trioptic Code 39
N	Coupon Code
R	GS1 DataBar Family
T	UCC Composite, TLC 39
X	PDF417, Macro PDF417, Micro PDF417
z	Aztec, Aztec Rune
P00	Data Matrix
P01	QR Code, MicroQR
P02	Maxicode
P03	US Postnet

Table 28 Symbol Code Characters (Continued)

Code Character	Code Type
P04	US Planet
P05	Japan Postal
P06	UK Postal
P08	Netherlands KIX Code
P09	Australian Postal
P0A	USPS 4CB/One Code/Intelligent Mail
P0B	UPU FICS Postal

AIM Code Identifiers

Each AIM Code Identifier contains the three-character string **jcm** where:

- j = Flag Character (ASCII 93)
- c = Code Character (see [Table 29](#))
- m = Modifier Character (see [Table 30](#))

Table 29 Aim Code Characters

Code Character	Code Type
A	Code 39, Code 39 Full ASCII, Code 32
C	Code 128, Coupon (Code 128 portion)
d	Data Matrix
E	UPC/EAN, Coupon (UPC portion)
e	GS1 DataBar Family
F	Codabar
G	Code 93
H	Code 11
I	Interleaved 2 of 5
L	PDF417, Macro PDF417, Micro PDF417
M	MSI
Q	QR Code, MicroQR
S	Discrete 2 of 5, IATA 2 of 5
U	Maxicode

Table 29 Aim Code Characters (Continued)

Code Character	Code Type
z	Aztec, Aztec Rune
X	Bookland EAN, Trioptic Code 39, US Postnet, US Planet, UK Postal, Japan Postal, Australian Postal, Netherlands KIX Code, USPS 4CB/One Code/Intelligent Mail, UPU FICS Postal

The modifier character is the sum of the applicable option values based on [Table 30](#).

Table 30 Modifier Characters

Code Type	Option Value	Option
Code 39	0	No check character or Full ASCII processing.
	1	Reader has checked one check character.
	3	Reader has checked and stripped check character.
	4	Reader has performed Full ASCII character conversion.
	5	Reader has performed Full ASCII character conversion and checked one check character.
	7	Reader has performed Full ASCII character conversion and checked and stripped check character.
	Example: A Full ASCII barcode with check character W, A+I+MI+DW , is transmitted as J A7AIMID where 7 = (3+4).	
Trioptic Code 39	0	No option specified at this time. Always transmit 0.
	Example: A Trioptic barcode 412356 is transmitted as J X0412356	
Code 128	0	Standard data packet, no Function code 1 in first symbol position.
	1	Function code 1 in first symbol character position.
	2	Function code 1 in second symbol character position.
	Example: A Code (EAN) 128 barcode with Function 1 character ^{FNC1} in the first position, AIMID is transmitted as J C1AIMID	
I 2 of 5	0	No check digit processing.
	1	Reader has validated check digit.
	3	Reader has validated and stripped check digit.
	Example: An I 2 of 5 barcode without check digit, 4123, is transmitted as J I04123	
Codabar	0	No check digit processing.
	1	Reader has checked check digit.
	3	Reader has stripped check digit before transmission.
	Example: A Codabar barcode without check digit, 4123, is transmitted as J F04123	

Table 30 Modifier Characters (Continued)

Code Type	Option Value	Option
Code 93	0	No options specified at this time. Always transmit 0.
	Example: A Code 93 barcode 012345678905 is transmitted as JG00 12345678905	
MSI	0	Check digits are sent.
	1	No check digit is sent.
	Example: An MSI barcode 4123, with a single check digit checked, is transmitted as JM1 4123	
D 2 of 5	0	No options specified at this time. Always transmit 0.
	Example: A D 2 of 5 barcode 4123, is transmitted as JS0 4123	
UPC/EAN	0	Standard data packet in full EAN format, i.e. 13 digits for UPC-A, UPC-E, and EAN-13 (not including supplemental data).
	1	Two digit supplemental data only.
	2	Five digit supplemental data only.
	3	Combined data packet comprising 13 digits from EAN-13, UPC-A or UPC-E symbol and 2 or 5 digits from supplemental symbol.
	4	EAN-8 data packet.
	Example: A UPC-A barcode 012345678905 is transmitted as JE000 12345678905	
Bookland EAN	0	No options specified at this time. Always transmit 0.
	Example: A Bookland EAN barcode 123456789X is transmitted as JX0 123456789X	
Code 11	0	Single check digit
	1	Two check digits
	3	Check characters validated but not transmitted.
GS1 DataBar Family		No option specified at this time. Always transmit 0. GS1 DataBar-14 and GS1 DataBar Limited transmit with an Application Identifier "01". Note: In GS1-128 emulation mode, GS1 DataBar is transmitted using Code 128 rules (i.e., J C1).
	Example: A GS1 DataBar-14 barcode 100123456788902 is transmitted as Je001 100123456788902.	

Table 30 Modifier Characters (Continued)

Code Type	Option Value	Option
EAN.UCC Composites (GS1 DataBar, GS1-128, 2D portion of UPC composite)		Native mode transmission. Note: UPC portion of composite is transmitted using UPC rules.
	0	Standard data packet.
	1	Data packet containing the data following an encoded symbol separator character.
	2	Data packet containing the data following an escape mechanism character. The data packet does not support the ECI protocol.
	3	Data packet containing the data following an escape mechanism character. The data packet supports the ECI protocol.
		GS1-128 emulation Note: UPC portion of composite is transmitted using UPC rules.
	1	Data packet is a GS1-128 symbol (i.e., data is preceded with]JC1).
PDF417, Micro PDF417	0	Reader set to conform to protocol defined in 1994 PDF417 symbology specifications. Note: When this option is transmitted, the receiver cannot reliably determine whether ECIs have been invoked or whether data byte 92 _{DEC} has been doubled in transmission.
	1	Reader set to follow the ECI protocol (Extended Channel Interpretation). All data characters 92 _{DEC} are doubled.
	2	Reader set for Basic Channel operation (no escape character transmission protocol). Data characters 92 _{DEC} are not doubled. Note: When decoders are set to this mode, unbuffered Macro symbols and symbols requiring the decoder to convey ECI escape sequences cannot be transmitted.
	3	The barcode contains a GS1-128 symbol, and the first codeword is 903-907, 912, 914, 915.
	4	The barcode contains a GS1-128 symbol, and the first codeword is in the range 908-909.
	5	The barcode contains a GS1-128 symbol, and the first codeword is in the range 910-911.
	Example: A PDF417 barcode ABCD, with no transmission protocol enabled, is transmitted as]L2ABCD.	
Data Matrix	0	ECC 000-140, not supported.
	1	ECC 200.
	2	ECC 200, FNC1 in first or fifth position.
	3	ECC 200, FNC1 in second or sixth position.
	4	ECC 200, ECI protocol implemented.
	5	ECC 200, FNC1 in first or fifth position, ECI protocol implemented.
	6	ECC 200, FNC1 in second or sixth position, ECI protocol implemented.

Table 30 Modifier Characters (Continued)

Code Type	Option Value	Option
MaxiCode	0	Symbol in Mode 4 or 5.
	1	Symbol in Mode 2 or 3.
	2	Symbol in Mode 4 or 5, ECI protocol implemented.
	3	Symbol in Mode 2 or 3, ECI protocol implemented in secondary message.
QR Code	0	Model 1 symbol.
	1	Model 2 / MicroQR symbol, ECI protocol not implemented.
	2	Model 2 symbol, ECI protocol implemented.
	3	Model 2 symbol, ECI protocol not implemented, FNC1 implied in first position.
	4	Model 2 symbol, ECI protocol implemented, FNC1 implied in first position.
	5	Model 2 symbol, ECI protocol not implemented, FNC1 implied in second position.
	6	Model 2 symbol, ECI protocol implemented, FNC1 implied in second position.
Aztec	0	Aztec symbol.
	C	Aztec Rune symbol.

Alphanumeric and Numeric Barcodes

Numeric Barcodes

For parameters requiring specific numeric values, scan the appropriately numbered barcode(s).



Numeric Barcodes (continued)



Cancel

To correct an error or change a selection, scan the barcode below.



Alphanumeric Barcodes

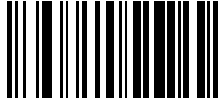

Space



#



\$



%

Alphanumeric Keyboard (continued)



*



+



-



.



/

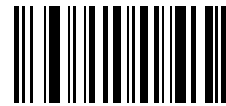

!

Alphanumeric Keyboard (continued)



“



&



\$

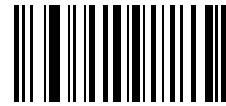

(



)



:

Alphanumeric Keyboard (continued)



;

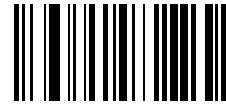

<



=

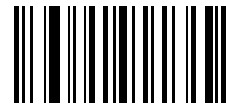

>

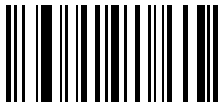

?

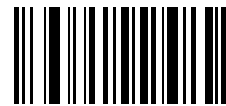

@

Alphanumeric Keyboard (continued)

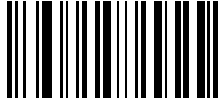

[

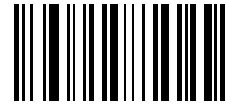

\



]



^

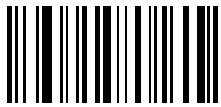

-

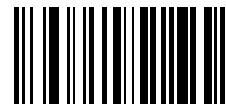

,

Alphanumeric Keyboard (continued)



NOTE: The barcodes that follow should not be confused with those on the numeric keypad.



0

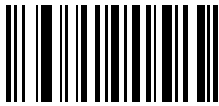

1

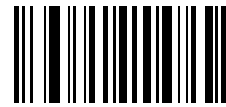

2



3

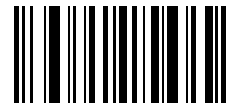

4



5

Alphanumeric Keyboard (continued)



6

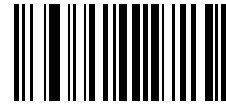

7



8

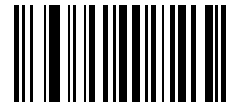

9



End of Message



Cancel

Alphanumeric Keyboard (continued)



A



B



C

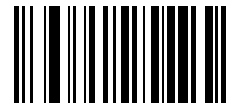

D

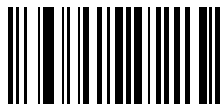

E

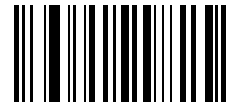

F

Alphanumeric Keyboard (continued)



G

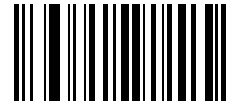

H



I

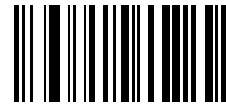

J



K

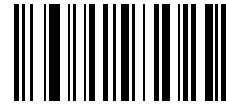

L

Alphanumeric Keyboard (continued)



M



N



O

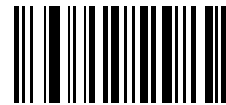

P

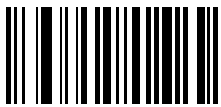

Q

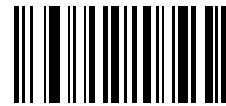

R

Alphanumeric Keyboard (continued)



S

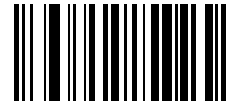

T

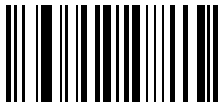

U



V



W

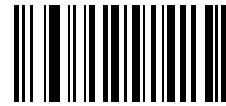

X

Alphanumeric Keyboard (continued)



Y



Z

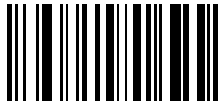

a

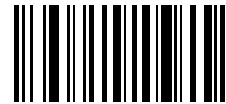

b



c

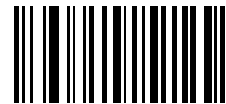

d

Alphanumeric Keyboard (continued)

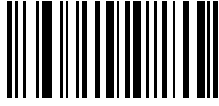

e



f



g

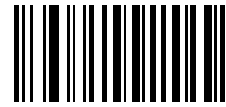

h



i



j

Alphanumeric Keyboard (continued)

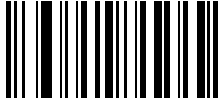

k

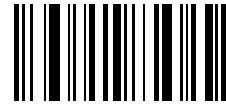

l

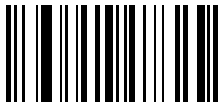

m



n



o

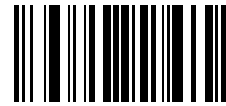

p

Alphanumeric Keyboard (continued)

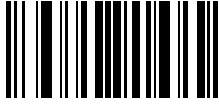

q

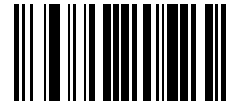

r

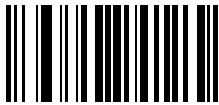

s

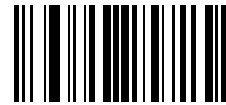

t

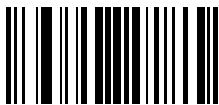

u

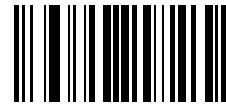

v

Alphanumeric Keyboard (continued)



w

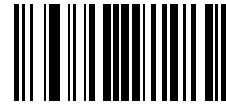

x

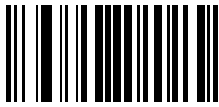

y

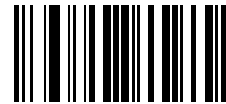

z

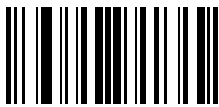

{

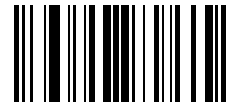

|

Alphanumeric Keyboard (continued)



}



~

Sample Barcodes

Code 39



123ABC

UPC/EAN

UPC-A, 100%



0 1 2 3 4 5 6 7 8 9 0 5

EAN-13, 100%



Code 128



12345678901234567890123456789012345678901234

Interleaved 2 of 5



GS1 DataBar-14



NOTE: DataBar-14 must be enabled to read the barcode below.



7612341562341

PDF417

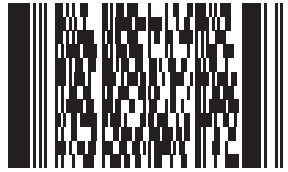

Data Matrix



Maxicode

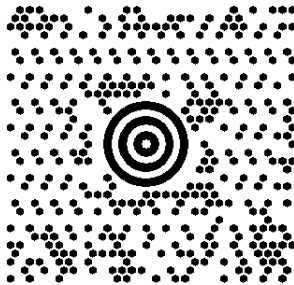

QR Code



US Postnet



UK Postal



Country Codes

Introduction

This chapter provides instructions for configuring the keyboard when the RS5100 is operating in Bluetooth HID mode.

To select a code page for the country keyboard type, see [Country Keyboard Types \(Country Codes\)](#).

Throughout the programming barcode menus, default values are indicated with asterisks (*).

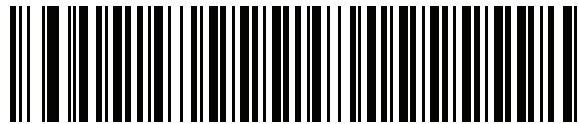

*Indicates Default — *US English (North American) — Feature/Option

Country Keyboard Types (Country Codes)

Scan the barcode corresponding to the keyboard type. This setting applies only to the Bluetooth Keyboard (HID) device.



NOTE: For best results when using international keyboards, enable [Quick Keypad Emulation on page 38](#).



IMPORTANT: Some country keyboard barcode types are specific to certain Windows Operating Systems (i.e., XP, and Win 7 or higher). Barcodes requiring a specific Windows OS are noted so in their barcode captions.

Use the **French International** barcode for Belgian French keyboards.

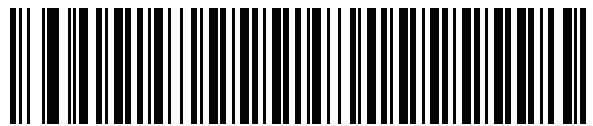

***US English (North American)**

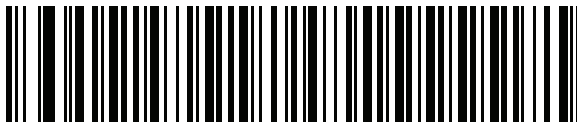

US English (Mac)

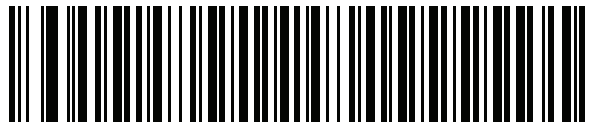

Albanian



Arabic (101)



Arabic (102)

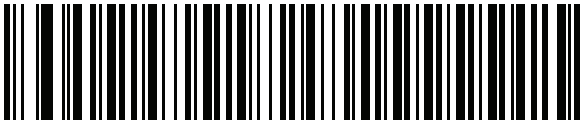

Arabic (102) AZERTY

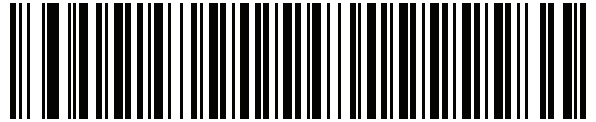

Azeri (Latin)

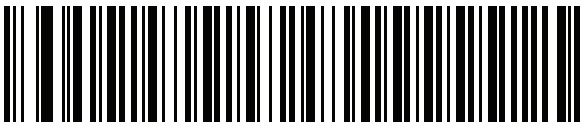

Azeri (Cyrillic)

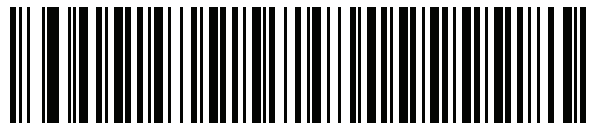

Belarusian

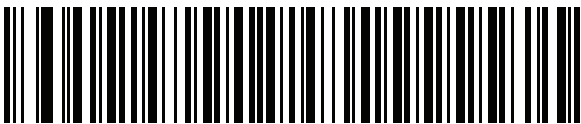

Bosnian (Latin)



Bosnian (Cyrillic)



Bulgarian (Latin)

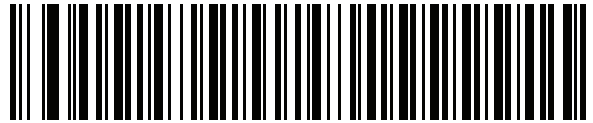

**Bulgarian Cyrillic (Typewriter)
(Bulgarian -Windows XP
Typewriter - Win 7 or higher)**

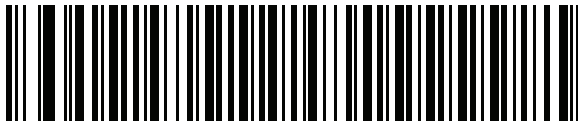

Canadian French Win7



Canadian French (Legacy)



Canadian Multilingual Standard



Chinese (ASCII)



Chinese (Simplified)*



Chinese (Traditional)*

*For CJK keyboard types, see [CKJ Decode Control](#).

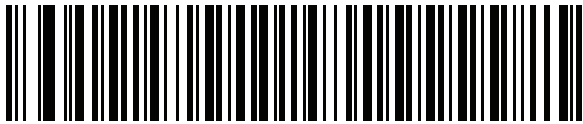

Croatian



Czech

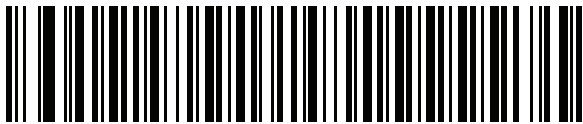

Czech (Programmer)



Czech (QWERTY)



Danish

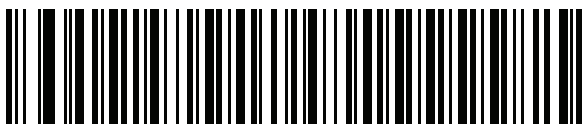

Dutch (Netherlands)

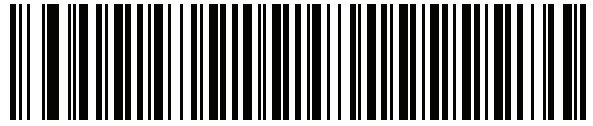

Estonian

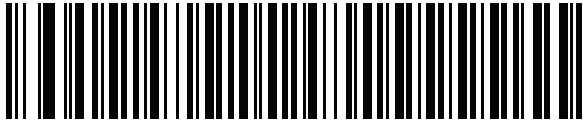

Faeroese

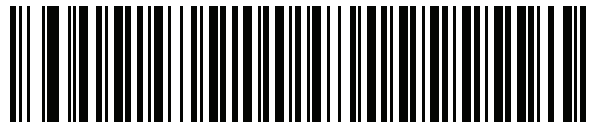

Finnish

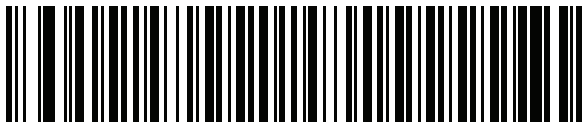

French (France)

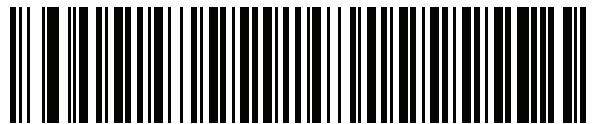

**French International
(Belgian French)**



French (Canada) 95/98



French (Canada) 2000/XP*

Country Codes

*Note that there is also a country code barcode for [Canadian Multilingual Standard on page 359](#). Be sure to select the appropriate barcode for your host system.

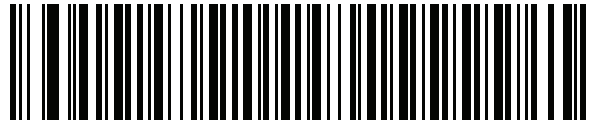

Galician

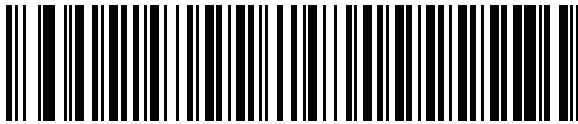

German

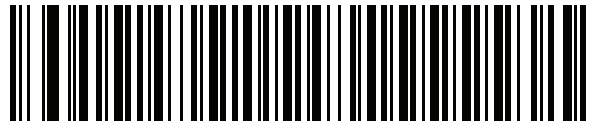

Greek Latin

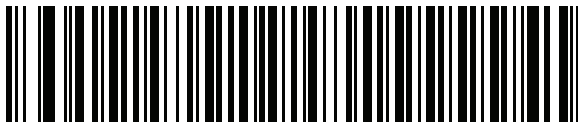

Greek (220) Latin



Greek (319) Latin



Greek



Greek (220)

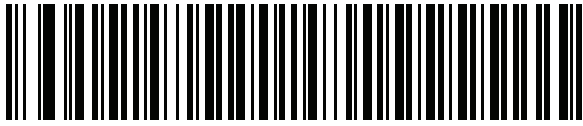

Greek (319)

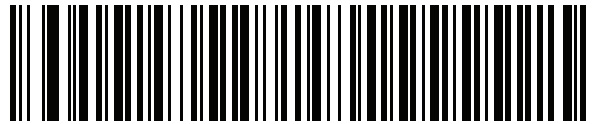

Greek Polytonic

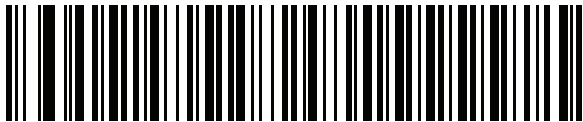

Hebrew Israel

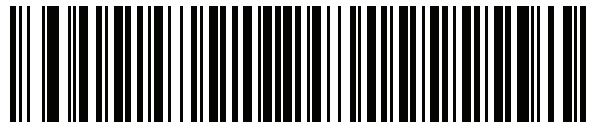

Hungarian

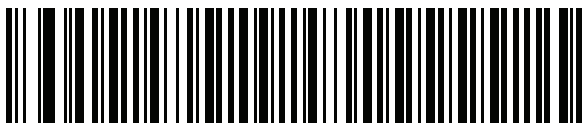

Hungarian_101KEY



Icelandic



Irish



Italian

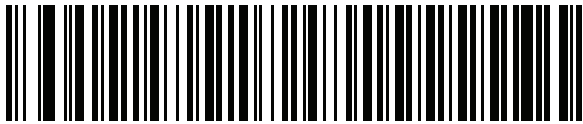

Italian (142)

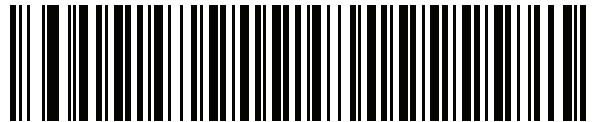

Japanese (ASCII)

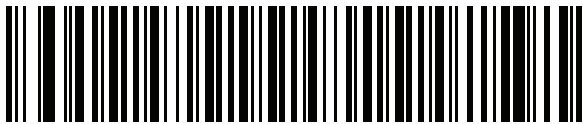

Japanese (SHIFT-JIS)*

*For CJK keyboard types, see [CJK Decode Control](#).



Kazakh



Korean (ASCII)



Korean (Hangul)*

Country Codes

*For CJK keyboard types, see [CJK Decode Control](#).

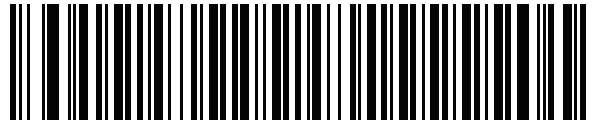

Kyrgyz

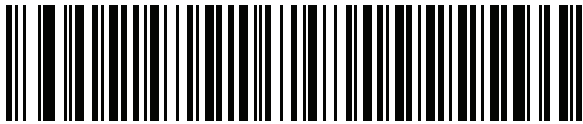

Latin American



Latvian

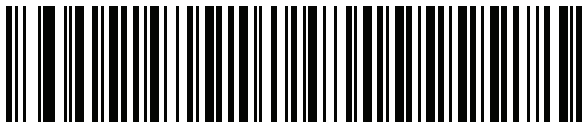

Latvian (QWERTY)

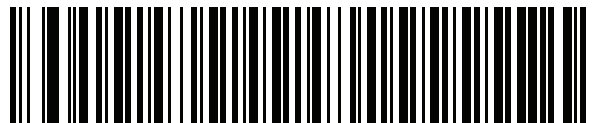

Lithuanian



Lithuanian (IBM)



Macedonian (FYROM)

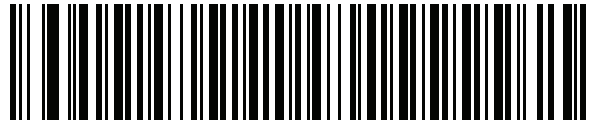

Maltese_47KEY

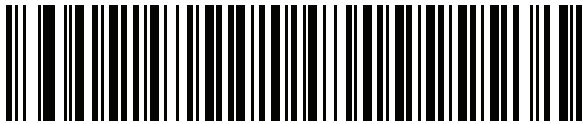

Mongolian

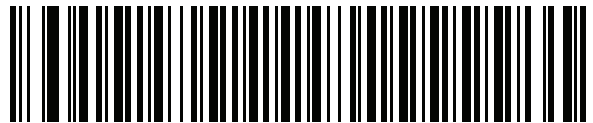

Norwegian

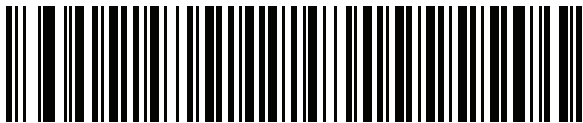

Polish (214)

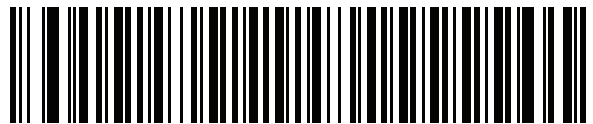

Polish (Programmer)



**Portuguese (Brazil)
(Windows XP)**



Portuguese (Brazilian ABNT)

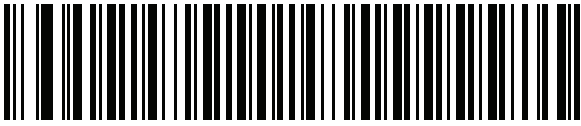

Portuguese (Brazilian ABNT2)

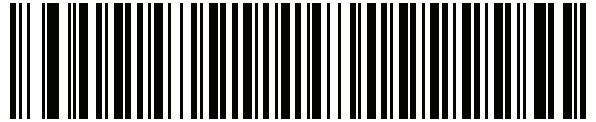

Portuguese (Portugal)

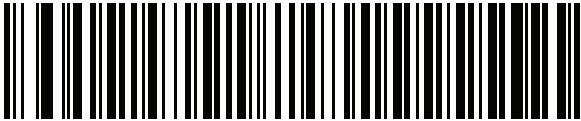

**Romanian
(Windows XP)**

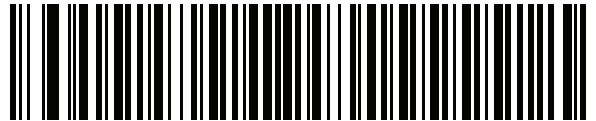

**Romanian (Legacy)
(Win 7 or higher)**

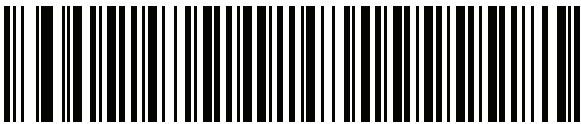

**Romanian (Standard)
(Win 7 or higher)**



**Romanian (Programmer)
(Win 7 or higher)**

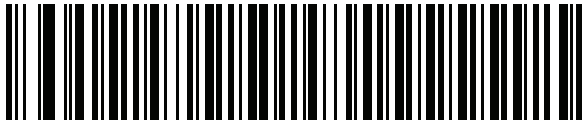

Russian

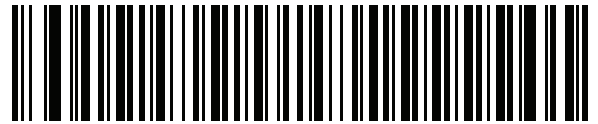

Russian (Typewriter)

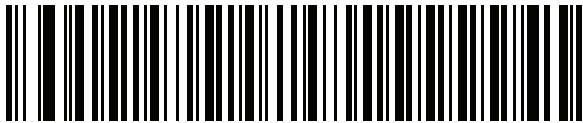

Serbian (Latin)

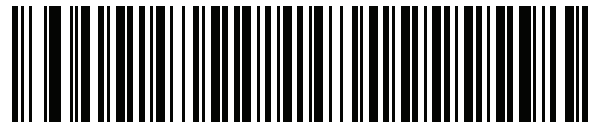

Serbian (Cyrillic)



Slovak



Slovak (QWERTY)



Slovenian

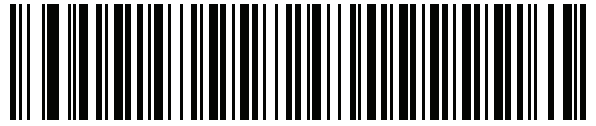

Spanish

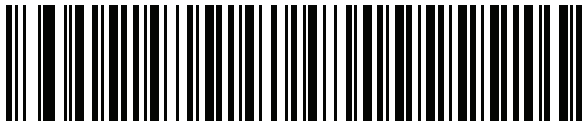

Spanish (Variation)

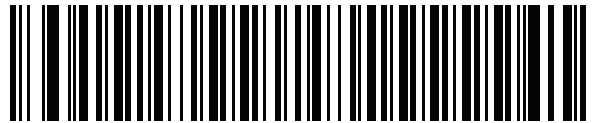

Swedish

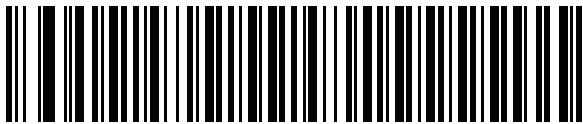

Swiss French

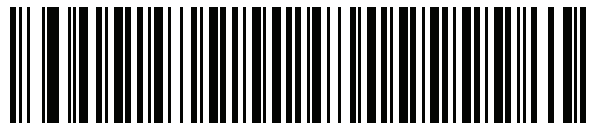

Swiss German

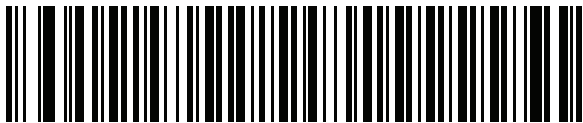

Tatar



Thai (Kedmanee)

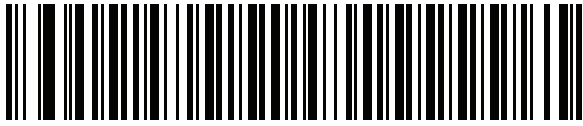

Turkish F

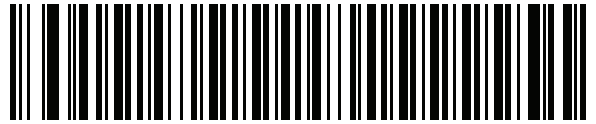

Turkish Q

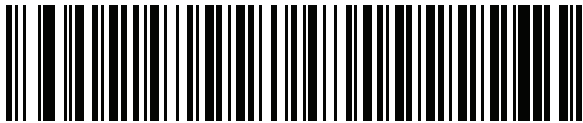

UK English

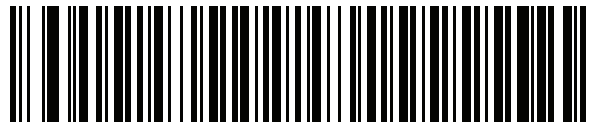

Ukrainian



US Dvorak



US Dvorak Left



US Dvorak Right

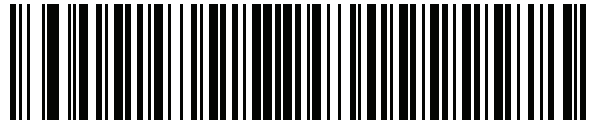

US International

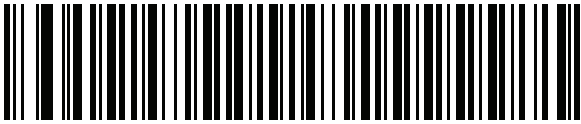

Uzbek

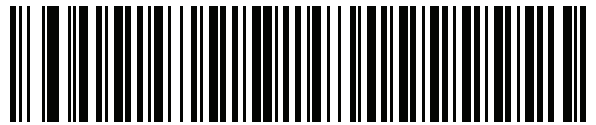

Vietnamese

Country Code Pages

Introduction

This chapter provides barcodes for selecting code pages for the country keyboard type selected in [Country Codes](#). If the default code page in [Table 31](#) is appropriate for your selected country keyboard type, you do not need to scan a country code page barcode.



NOTE: ADF rules can also specify a code page based on the symbology and other ADF criteria. Refer to the [Advanced Data Formatting Programmer Guide](#).

Country Code Page Defaults

[Table 31](#) lists the code page default for each country keyboard.

Table 31 Country Code Page Defaults

Country Keyboard	Code Page Default
US English (North American)	Windows 1252
US English (Mac)	Mac CP10000
Albanian	Windows 1250
Arabic 101	Windows 1256
Arabic 102	Windows 1256
Arabic 102 AZERTY	Windows 1256
Azeri Latin	Windows 1254
Azeri Cyrillic	Windows 1251
Belarusian	Windows 1251
Bosnian Latin	Windows 1250
Bosnian Cyrillic	Windows 1251
Bulgarian Latin	Windows 1250
Bulgarian Cyrillic	Windows 1251

Table 31 Country Code Page Defaults (Continued)

Country Keyboard	Code Page Default
Canadian French Win7	Windows 1252
Canadian French (Legacy)	Windows 1252
Canadian Multilingual	Windows 1252
Croatian	Windows 1250
Chinese ASCII	Windows 1252
Chinese (Simplified)	Windows 936, GBK
Chinese (Traditional)	Windows 950, Big5
Czech	Windows 1250
Czech Programmers	Windows 1250
Czech QWERTY	Windows 1250
Danish	Windows 1252
Dutch Netherland	Windows 1252
Estonian	Windows 1257
Faeroese	Windows 1252
Finnish	Windows 1252
French (France)	Windows 1252
French (Canada) 95/98	Windows 1252
French (Canada) 2000/XP	Windows 1252
French International (Belgian French)	Windows 1252
Galician	Windows 1252
German	Windows 1252
Greek Latin	Windows 1252
Greek220 Latin	Windows 1253
Greek319 Latin	Windows 1252
Greek	Windows 1253
Greek220	Windows 1253
Greek319	Windows 1253
Greek Polytonic	Windows 1253
Hebrew Israel	Windows 1255
Hungarian	Windows 1250
Hungarian_101KEY	Windows 1250

Table 31 Country Code Page Defaults (Continued)

Country Keyboard	Code Page Default
Icelandic	Windows 1252
Irish	Windows 1252
Italian	Windows 1252
Italian_142	Windows 1252
Japanese ASCII	Windows 1252
Japanese (Shift-JIS)	Windows 932, Shift-JIS
Kazakh	Windows 1251
Korean ASCII	Windows 1252
Korean (Hangul)	Windows 949, Hangul
Kyrgyz Cyrillic	Windows 1251
Latin America	Windows 1252
Latvian	Windows 1257
Latvian QWERTY	Windows 1257
Lithuanian	Windows 1257
Lithuanian_IBM	Windows 1257
Macedonian -FYROM	Windows 1251
Maltese_47KEY	Windows 1252
Mongolian-Cyrillic	Windows 1251
Norwegian	Windows 1252
Polish_214	Windows 1250
Polish Programmer	Windows 1250
Portuguese Brazil	Windows 1252
Portuguese Brazilian ABNT	Windows 1252
Portuguese Brazilian ABNT2	Windows 1252
Portuguese Portugal	Windows 1252
Romanian	Windows 1250
Romanian Legacy	Windows 1250
Romanian Standard	Windows 1250
Romanian Programmer	Windows 1250
Russian	Windows 1251
Russian Typewriter	Windows 1251

Table 31 Country Code Page Defaults (Continued)

Country Keyboard	Code Page Default
Serbian Latin	Windows 1250
Serbian Cyrillic	Windows 1251
Slovak	Windows 1250
Slovak QWERTY	Windows 1250
Slovenian	Windows 1250
Spanish	Windows 1252
Spanish Variation	Windows 1252
Swedish	Windows 1252
Swiss French	Windows 1252
Swiss German	Windows 1252
Tatar	Windows 1251
Thai-Kedmanee	Windows 874
Turkish F	Windows 1254
Turkish Q	Windows 1254
Ukrainian	Windows 1251
United Kingdom	Windows 1252
United States	Windows 1252
US Dvorak	Windows 1252
US Dvorak Left Hand	Windows 1252
US Dvorak Right Hand	Windows 1252
US International	Windows 1252
Uzbek Cyrillic	Windows 1251
Vietnamese	Windows 1258

Country Code Page Barcodes

Scan the barcode corresponding to the country keyboard code page.



Windows 1250
Latin 2, Central European

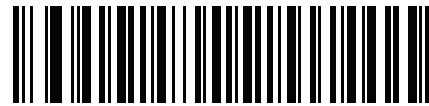

Windows 1251
Cyrillic, Slavic

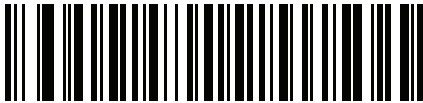

Windows 1252
Latin 1, Western European

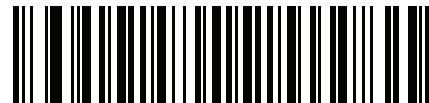

Windows 1253
Greek

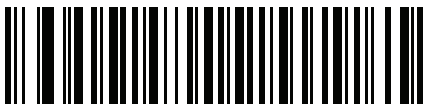

Windows 1254
Latin 5, Turkish

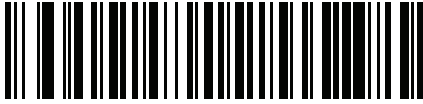

Windows 1255
Hebrew



Windows 1256
Arabic



Windows 1257
Baltic

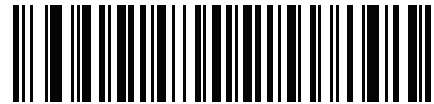

Windows 1258
Vietnamese

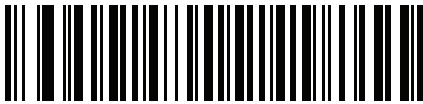

Windows 874
Thai

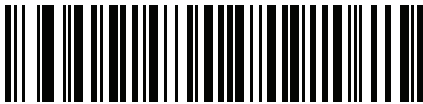

Windows 20866
Cyrillic KOI8-R



**Windows 932
Japanese Shift-JIS**



**Windows 936
Simplified Chinese GBK**

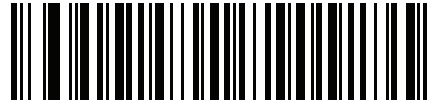

**Windows 54936
Simplified Chinese GB18030**



**Windows 949
Korean Hangul**

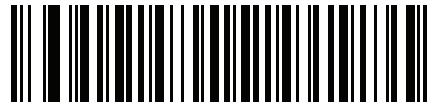

**Windows 950
Traditional Chinese Big5**



**MS-DOS 437
Latin US**

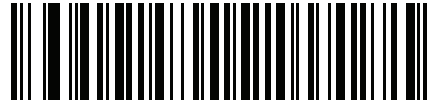

MS-DOS 737
Greek



MS-DOS 775
Baltic

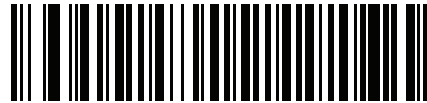

MS-DOS 850
Latin 1



MS-DOS 852
Latin 2



MS-DOS 855
Cyrillic

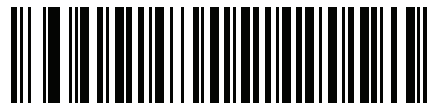

MS-DOS 857
Turkish

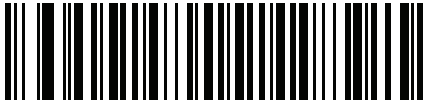

MS-DOS 860
Portuguese

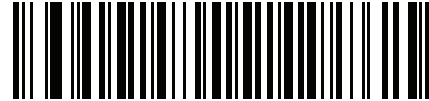

MS-DOS 861
Icelandic



MS-DOS 862
Hebrew

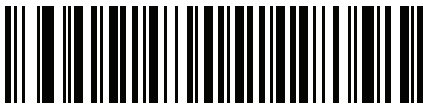

MS-DOS 863
French Canada

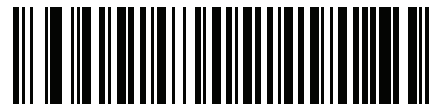

MS-DOS 865
Nordic



MS-DOS 866
Cyrillic

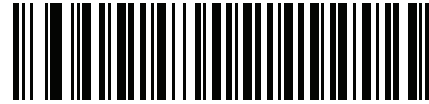

MS-DOS 869
Greek 2

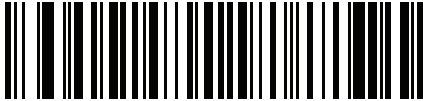

ISO 8859-1
Latin 1, Western European

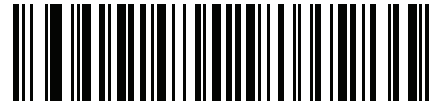

ISO 8859-2
Latin 2, Central European



ISO 8859-3
Latin 3, South European

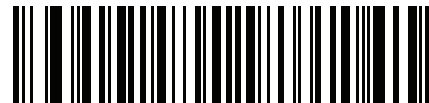

ISO 8859-4
Latin 4, North European



ISO 8859-5
Cyrillic



ISO 8859-6
Arabic

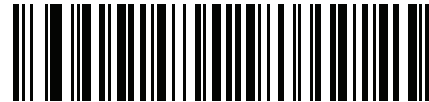

ISO 8859-7
Greek



ISO 8859-8
Hebrew

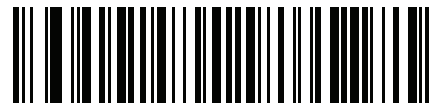

ISO 8859-9
Latin 5, Turkish



ISO 8859-10
Latin 6, Nordic



ISO 8859-11
Thai



ISO 8859-13
Latin 7, Baltic

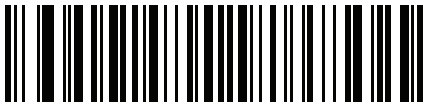

ISO 8859-14
Latin 8, Celtic

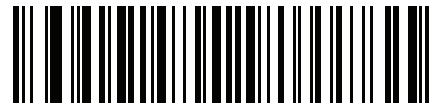

ISO 8859-15
Latin 9



ISO 8859-16
Latin 10, South-Eastern European



UTF-8



UTF-16LE
UTF-16 Little Endian



UTF-16BE
UTF-16 Big Endian

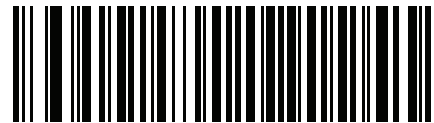

Mac CP10000
Roman

CKJ Decode Control

Introduction

This appendix describes control parameters for CJK (Chinese, Japanese, Korean) barcode decode through Bluetooth HID Keyboard Emulation mode.



NOTE: Because ADF does not support CJK character processing, there is no format manipulation for CJK output.

CJK Control Parameters

Unicode Output Control

Parameter # 973

For a Unicode encoded CJK barcode, select one of the following options for unicode output:

- **Universal Output to Unicode and MBCS Application** - This default method applies to Unicode and MBCS expected applications, such as MS Word and Notepad on a Windows host.



NOTE: To support Unicode universal output, set up the registry table for the Windows host. See [Unicode/CJK Decode Setup with Windows Host on page 391](#).

- **Output to Unicode Application Only** - This method applies only to Unicode expected applications, such as MS Word and WordPad, but not Notepad.



***Universal Output
(0)**



**Unicode Application Only
(1)**

CJK Output Method to Windows Host

Parameter # 972

For a national standard encoded CJK barcode, select one of the following options for CJK output to a Windows host:

- **Universal CJK Output** - This is the default universal CJK output method for US English IME or Chinese/Japanese/Korean ASCII IME on a Windows host. This method converts CJK characters to Unicode and emulates the characters when transmitting to the host. Use the [Unicode Output Control](#) parameter to control Unicode output.



NOTE: To support universal CJK output, set up the registry table for the Windows host. See [Unicode/CJK Decode Setup with Windows Host on page 391](#).

- **Other options for CJK output** - With the following methods, the scanner sends the CJK character hexadecimal internal code (Nei Ma) value to host, or converts the CJK character to Unicode and sends the hexadecimal Unicode value to host. When using these methods, the Windows host must select the corresponding IME to accept the CJK character. See [Unicode/CJK Decode Setup with Windows Host on page 391](#).
 - **Japanese Unicode Output**
 - **Simplified Chinese GBK Code Output**
 - **Simplified Chinese Unicode Output**
 - **Korean Unicode Code Output**
 - **Traditional Chinese Big5 Code Output** (Windows XP)
 - **Traditional Chinese Big5 Code Output** (Windows 7)
 - **Traditional Chinese Unicode Code Output** (Windows XP)
 - **Traditional Chinese Unicode Code Output** (Windows 7)



NOTE: The Unicode emulate output method depends on the host system (Windows XP or Windows 7).



***Universal CJK Output
(0)**



**Japanese Unicode Output
(34)**

(for Japanese Unicode Output, select Simplified Chinese Unicode IME on the Windows host)

CJK Output Method to Windows Host (continued)



**Chinese (Simplified) GBK Output
(1)**



**Chinese (Simplified) Unicode Output
(2)**



**Korean Unicode Output
(50)**

(for Korean Unicode Output, select Simplified Chinese Unicode IME on the Windows host)

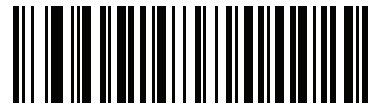

**Chinese (Traditional) Big5 Output (Windows XP)
(17)**



**Chinese (Traditional) Big5 Output (Windows 7)
(19)**

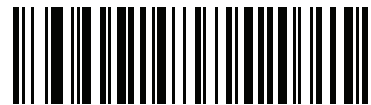

**Chinese (Traditional) Unicode Output (Windows XP)
(18)**



**Chinese (Traditional) Unicode Output (Windows 7)
(20)**

Non-CJK UTF Barcode Output

Parameter # 960

Some country keyboard type layouts contain characters that do not exist in the default code page (see [Country Keyboard Type Missing Characters on page 389](#)). Although the default code page can not encode these characters in a barcode, they can be encoded in the UTF-8 barcode. Scan this parameter barcode to output the Unicode values by emulation mode.



NOTE: Use this special country keyboard type to decode the non-CJK UTF-8 barcode. After decoding, re-configure the scanner to use the original country keyboard type.

Use US English IME on Windows. See [Unicode Output Control on page 386](#).

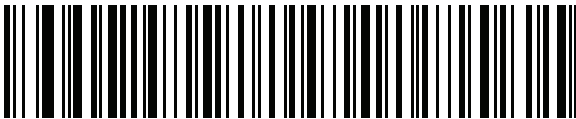

Non-CJK UTF-8 Emulation Output

Country Keyboard Type Missing Characters

Country keyboard type: **Tatar, Uzbek, Mongolian, Kyrgyz, Kazakh and Azeri**

Default code page: CP1251

Missing characters:

Table 32 Country Keyboard Type: Tatar, Uzbek, Mongolian, Kyrgyz, Kazakh and Azeri

ƒ	F
χ	Χ
κ	Κ
h	h
ϑ	Θ
ϑ	Θ
γ	Υ
Ң	Ң
Ж	Ж
Ғ	
Ң	Ң
Ү	Ү
Қ	Қ

Table 32 Country Keyboard Type: Tatar, Uzbek, Mongolian, Kyrgyz, Kazakh and Azeri (Continued)

җ	Ҙ
к	К

Country keyboard type: **Romanian (Standard)**

Default code page: CP1250

Missing characters:

Table 33 Country Keyboard Type: Romanian (Standard)

ș	Ș
ț	Ț

Country keyboard type: **Portuguese-Brazilian (ABNT), Portuguese-Brazilian (ABNT2)**

Default code page: CP1252

Missing character: **Ç**

Country keyboard type: **Azeri-Latin**

Default code page: CP1254

Missing characters: ə , Ə

Unicode/CJK Decode Setup with Windows Host

This section describes how to set up CJK decode with a Windows host.

Setting Up the Windows Registry Table for Unicode Universal Output

To support the Unicode universal output method, set up the Windows host registry table as follows:

1. Select **Start > Run > regedt32** to start the registry editor.
2. Under **HKEY_Current_User\Control Panel\Input Method**, set **EnableHexNumpad** to **1** as follows:

```
[HKEY_CURRENT_USER\Control Panel\Input Method]
```

```
"EnableHexNumpad"="1"
```

If this key does not exist, add it as type **REG_SZ** (string value).

3. Reboot the computer to implement the registry change.

Adding CJK IME on Windows

To add the desired CJK input language:

1. Click **Start > Control Panel**.
2. If the Control Panel opens in category view, select **Switch to Classic View** in the top left corner.
3. Select **Regional and Language Options**.
4. Click the **Language** tab.
5. Under **Supplemental Language Support**, select the **Install Files for East Asian Languages** check box if not already selected, and click **Apply**. This may require a Windows installation CD to install the required files. This step ensures that the East Asian Languages (CJK) are available.
6. Under **Text Services and Input Language**, click **Details**.
7. Under **Installed Services**, click **Add**.
8. In the **Add Input Language** dialog box, choose the CJK input language and keyboard layout or Input Method Editor (IME) to add.
9. Click **OK** twice. The language indicator appears in the system tray (at bottom right corner of the desktop by default). To switch between input languages (keyboard languages) select the language indicator in the system tray.
10. Select the language indicator in the system tray to select the desired country keyboard type.
11. Verify that the characters displayed on each country's keyboard appear.

Selecting the Simplified Chinese Input Method on the Host

To select the Simplified Chinese input method:

- Select Unicode/GBK input on Windows XP: **Chinese (Simplified) - NeiMa**, then click the input bar to select **Unicode** or **GBK NeiMa** input.

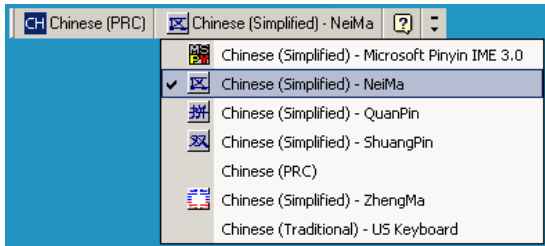

Or



- Select Unicode/GBK input on Windows7: **Chinese (Simplified) - Microsoft Pinyin New Experience Input Style**, then select **Tool Menu > Secondary Inputs > Unicode Input** or **GB Code Input**.

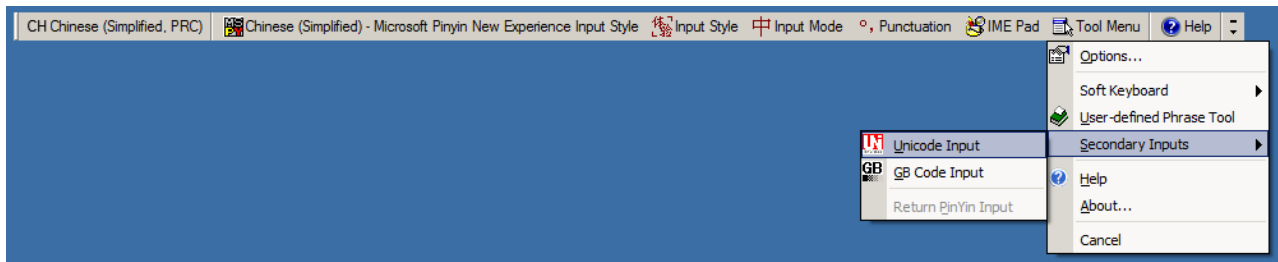

Selecting the Traditional Chinese Input Method on the Host

To select the Traditional Chinese input method:

- Select Unicode input on Windows XP: **Chinese (Traditional) - Unicode**

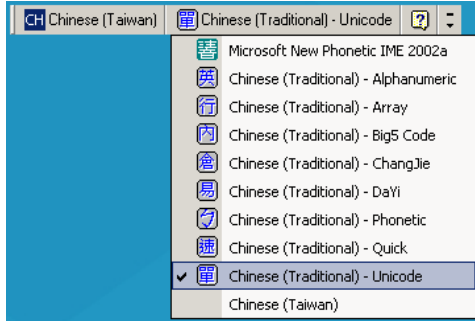

- Select Big5 input on Windows XP: **Chinese (Traditional) - Big5 Code**

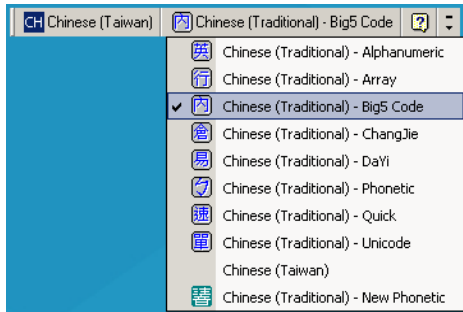

- Select Unicode/Big5 input on Windows 7: **Chinese (Traditional) - New Quick**. This option support both Unicode and Big5 input.



ASCII Character Sets

Table 34 ASCII Value Table

ASCII Value	Full ASCII Code 39 Encode Char	Keystroke
1000	%U	CTRL 2
1001	\$A	CTRL A
1002	\$B	CTRL B
1003	\$C	CTRL C
1004	\$D	CTRL D
1005	\$E	CTRL E
1006	\$F	CTRL F
1007	\$G	CTRL G
1008	\$H	CTRL H/ BACKSPACE ¹
1009	\$I	CTRL I/ HORIZONTAL TAB ¹
1010	\$J	CTRL J
1011	\$K	CTRL K
1012	\$L	CTRL L
1013	\$M	CTRL M/ ENTER ¹
1014	\$N	CTRL N
1015	\$O	CTRL O
1016	\$P	CTRL P
1017	\$Q	CTRL Q
1018	\$R	CTRL R
1019	\$S	CTRL S

The keystroke in bold transmits only if you enabled Function Key Mapping. Otherwise, the unbold keystroke transmits.

Table 34 ASCII Value Table (Continued)

ASCII Value	Full ASCII Code 39 Encode Char	Keystroke
1020	\$T	CTRL T
1021	\$U	CTRL U
1022	\$V	CTRL V
1023	\$W	CTRL W
1024	\$X	CTRL X
1025	\$Y	CTRL Y
1026	\$Z	CTRL Z
1027	%A	CTRL [
1028	%B	CTRL \
1029	%C	CTRL]
1030	%D	CTRL 6
1031	%E	CTRL -
1032	Space	Space
1033	/A	!
1034	/B	"
1035	/C	#
1036	/D	\$
1037	/E	%
1038	/F	&
1039	/G	'
1040	/H	(
1041	/I)
1042	/J	*
1043	/K	+
1044	/L	,
1045	-	-
1046	.	.
1047	/o	/
1048	0	0

The keystroke in bold transmits only if you enabled Function Key Mapping. Otherwise, the unbold keystroke transmits.

Table 34 ASCII Value Table (Continued)

ASCII Value	Full ASCII Code 39 Encode Char	Keystroke
1049	1	1
1050	2	2
1051	3	3
1052	4	4
1053	5	5
1054	6	6
1055	7	7
1056	8	8
1057	9	9
1058	/Z	:
1059	%F	;
1060	%G	<
1061	%H	=
1062	%I	>
1063	%J	?
1064	%V	@
1065	A	A
1066	B	B
1067	C	C
1068	D	D
1069	E	E
1070	F	F
1071	G	G
1072	H	H
1073	I	I
1074	J	J
1075	K	K
1076	L	L
1077	M	M

The keystroke in bold transmits only if you enabled Function Key Mapping. Otherwise, the unbold keystroke transmits.

Table 34 ASCII Value Table (Continued)

ASCII Value	Full ASCII Code 39 Encode Char	Keystroke
1078	N	N
1079	O	O
1080	P	P
1081	Q	Q
1082	R	R
1083	S	S
1084	T	T
1085	U	U
1086	V	V
1087	W	W
1088	X	X
1089	Y	Y
1090	Z	Z
1091	%K	[
1092	%L	\
1093	%M]
1094	%N	^
1095	%O	_
1096	%W	'
1097	+A	a
1098	+B	b
1099	+C	c
1100	+D	d
1101	+E	e
1102	+F	f
1103	+G	g
1104	+H	h
1105	+I	i
1106	+J	j

The keystroke in bold transmits only if you enabled Function Key Mapping. Otherwise, the unbold keystroke transmits.

Table 34 ASCII Value Table (Continued)

ASCII Value	Full ASCII Code 39 Encode Char	Keystroke
1107	+K	k
1108	+L	l
1109	+M	m
1110	+N	n
1111	+O	o
1112	+P	p
1113	+Q	q
1114	+R	r
1115	+S	s
1116	+T	t
1117	+U	u
1118	+V	v
1119	+W	w
1120	+X	x
1121	+Y	y
1122	+Z	z
1123	%P	{
1124	%Q	
1125	%R	}
1126	%S	~

The keystroke in bold transmits only if you enabled Function Key Mapping. Otherwise, the unbold keystroke transmits.

Table 35 ALT Key Standard Default Tables

ALT Keys	Keystroke
2064	ALT 2
2065	ALT A
2066	ALT B
2067	ALT C
2068	ALT D

Table 35 ALT Key Standard Default Tables (Continued)

ALT Keys	Keystroke
2069	ALT E
2070	ALT F
2071	ALT G
2072	ALT H
2073	ALT I
2074	ALT J
2075	ALT K
2076	ALT L
2077	ALT M
2078	ALT N
2079	ALT O
2080	ALT P
2081	ALT Q
2082	ALT R
2083	ALT S
2084	ALT T
2085	ALT U
2086	ALT V
2087	ALT W
2088	ALT X
2089	ALT Y
2090	ALT Z

Table 36 USB GUI Key Character Set

GUI Key	Keystroke
3000	Right Control Key
3048	GUI 0
3049	GUI 1
3050	GUI 2

Note: GUI Shift Keys - The Apple™ iMac keyboard has an apple key on either side of the space bar. Windows-based systems have a GUI key to the left of the left ALT key, and to the right of the right ALT key.

Table 36 USB GUI Key Character Set (Continued)

GUI Key	Keystroke
3051	GUI 3
3052	GUI 4
3053	GUI 5
3054	GUI 6
3055	GUI 7
3056	GUI 8
3057	GUI 9
3065	GUI A
3066	GUI B
3067	GUI C
3068	GUI D
3069	GUI E
3070	GUI F
3071	GUI G
3072	GUI H
3073	GUI I
3074	GUI J
3075	GUI K
3076	GUI L
3077	GUI M
3078	GUI N
3079	GUI O
3080	GUI P
3081	GUI Q
3082	GUI R
3083	GUI S
3084	GUI T
3085	GUI U
3086	GUI V
3087	GUI W

Note: GUI Shift Keys - The Apple™ iMac keyboard has an apple key on either side of the space bar. Windows-based systems have a GUI key to the left of the left ALT key, and to the right of the right ALT key.

Table 36 USB GUI Key Character Set (Continued)

GUI Key	Keystroke
3088	GUI X
3089	GUI Y
3090	GUI Z

Note: GUI Shift Keys - The Apple™ iMac keyboard has an apple key on either side of the space bar. Windows-based systems have a GUI key to the left of the left ALT key, and to the right of the right ALT key.

Table 37 PF Key Standard Default Table

PF Keys	Keystroke
4001	PF 1
4002	PF 2
4003	PF 3
4004	PF 4
4005	PF 5
4006	PF 6
4007	PF 7
4008	PF 8
4009	PF 9
4010	PF 10
4011	PF 11
4012	PF 12
4013	PF 13
4014	PF 14
4015	PF 15
4016	PF 16

Table 38 F key Standard Default Table

F Keys	Keystroke
5001	F 1
5002	F 2
5003	F 3
5004	F 4

Table 38 F key Standard Default Table (Continued)

F Keys	Keystroke
5005	F 5
5006	F 6
5007	F 7
5008	F 8
5009	F 9
5010	F 10
5011	F 11
5012	F 12
5013	F 13
5014	F 14
5015	F 15
5016	F 16
5017	F 17
5018	F 18
5019	F 19
5020	F 20
5021	F 21
5022	F 22
5023	F 23
5024	F 24

Table 39 Numeric Key Standard Default Table

Numeric Keypad	Keystroke
6042	*
6043	+
6044	Undefined
6045	-
6046	.
6047	/
6048	0
6049	1

Table 39 Numeric Key Standard Default Table (Continued)

Numeric Keypad	Keystroke
6050	2
6051	3
6052	4
6053	5
6054	6
6055	7
6056	8
6057	9
6058	Enter
6059	Num Lock

Table 40 Extended Keypad Standard Default Table

Extended Keypad	Keystroke
7001	Break
7002	Delete
7003	Pg Up
7004	End
7005	Pg Dn
7006	Pause
7007	Scroll Lock
7008	Backspace
7009	Tab
7010	Print Screen
7011	Insert
7012	Home
7013	Enter
7014	Escape
7015	Up Arrow
7016	Dn Arrow
7017	Left Arrow
7018	Right Arrow

RSM Attributes

Attributes for Querying Scanner Information

Remote Scanner Manager (RSM) attributes can be used to query information, like Serial Number and Battery Percentage, from a connected RS5100 scanner. The following table describes various attributes and their attribute numbers.

Table 41 Remote Scanner Manager (RSM) Attributes

Attribute Description	Attribute Number
Model Number	533
Serial Number	534
Date of Manufacture	535
Date of Service	536
Bluetooth MAC Address	541
Firmware Version	20004
Battery Voltage	30010
Battery Percentage	30012
Battery State of Health	30013
Battery Model Number	30017
Battery Manufacture Date	30018
Battery Full Charge Capacity	30020

BLE Beacons

BLE Beacons

BLE Beacons is designed to prevent the loss of scanners. A scanner emits an alert when it is about to lose its connection to a host device. Loss of connection may result when the scanner:

- reaches a low battery level
- stays inactive for too long
- moves too far away from the host

To enable beacons, one of the following three parameters must be enabled:

- [Beacon Upon Disconnection](#)
- [Unpaired Beacons](#)
- [Beacon Battery Threshold](#)

Beacons is disabled when the Beacon Battery, Beacons Upon Disconnection, and Unpaired Beacons parameters are disabled.

You can program all of the specific definitions for triggering the BLE Beacons alert using the parameters listed in the Parameter Defaults Table.

BLE Beacons Parameter Defaults

The following tables list the parameters and attributes relevant to BLE Beacons. If default parameters are acceptable, no change is required. Otherwise, use the associated programming barcodes to specify the correct value.

Table 42 BLE Beacons Defaults

Parameter	Parameter Number	Default
Low Power Mode*	128	Enable
Reconnect Attempt Interval	558	30 seconds
Auto-reconnect	604	Immediately
Bluetooth Friendly Name*	607	N/A
Discoverable Mode*	610	General

Table 42 BLE Beaconsing Defaults

Parameter	Parameter Number	Default
HID Features for Apple iOS*	1114	Disable
Wi-Fi Friendly Channel Exclusion*	1297	Use all Channels (Standard AFH)
Wi-Fi Friendly Mode*	1299	Disable
Radio Output Power	1324	High
Battery Threshold	1367, 1368, 1369	N/A
Bluetooth Security Levels*	1393	N/A
Link Supervision Timeout*	1698	2 seconds
Auto Un-Pairing	1708	Disable
Beacon Upon Disconnection	2403	Disable
Unpaired Beaconsing	2404	Disable
Beaconsing Beep	2405	Disable
Beacon Frequency	2406	100 ms
Beacon Battery Threshold	2407	30%
Beacon ID	2408, 2409	N/A

*Configure these parameters before pairing the scanner with a host device. Changing these parameters in a connected scanner may cause it to reset.

Table 43

BLE Beaconsing Attributes

Attribute	Attribute Number
Model Number	533
Serial Number	534
Date of Manufacture	535
Date of Service	536
Bluetooth MAC Address	541
Paging Activate	6032
ATT Beacon Command	6052
Firmware Version	20004
Device Type	20007

BLE Beaconing Attributes

Attribute	Attribute Number
Ring Scanner Firmware Package Version	20012
Beacon ID	20036
Ring Scanner Battery Status	30009
Battery Percentage	30012
Battery State of Health	30013
Battery Model Number	30017
Battery Manufacture Date	30018

Beaconing and Battery Use

Beaconing and scanning both use battery power. Table 42 shows how well the battery performs when the battery threshold (parameter 2407) is set to the default value of 37% at various temperatures. These results were calculating assuming use of an extended battery, starting at 100% charge, scanning with a 100% success rate.

Scans per Minute	12 hr Shift of Scanning at Room Temperature	Battery for 12 hr Shift of Scanning at -20°C	Battery for 12 hr Shift of Scanning at -30°C
8	Exceeds	Exceeds	Meets Marginally
10	Meets Easily	Exceeds	Meets Marginally
12	Meets Easily	Meets Easily	Meets Marginally
16	Meets Marginally	Meets Marginally	Meets Marginally

A battery will beacon for a minimum of 48 hours before it is fully drained. The beaconing battery life is calculated assuming:

- beaconing occurs within the operating temperature of the scanner
- use of an extended battery
- beaconing begins when the battery level is 37%

INDEX

Numerics

123Scan	23
requirements	24
2D barcodes	
aztec	240
aztec inverse	240
code 128 emulation	236
data matrix	237
data matrix inverse	238
han xin	241
han xin inverse	241
maxicode	238
microPDF417	235
microQR	240
PDF417	235
QR code	239

A

Acceptable Aiming Options	21
accessories	82
ADF	263
advanced data formatting	263
auto-reconnect	68

B

bar codes	
Australia post	250
Australia post format	251
auto-reconnect interval	68
batch mode	74, 76
beep after good decode	124
beep on insertion	124
beeper duration	127
beeper tone	126
beeper volume	125
Bluetooth technology support	33
bookland EAN	161
bookland ISBN	174
buffering	194, 195

cancel	334
Chinese 2 of 5	222
codabar	213
codabar CLSI editing	215
codabar lengths	213
codabar NOTIS editing	215
codabar start and stop characters	216
code 11	199
code 11 check digit verification	201
code 11 lengths	199
code 128	178
code 128 lengths	179
code 128 reduced quiet zone	185
code 128 security level	184
code 32 prefix	189
code 39	187
transmit buffer	196
code 39 check digit verification	191
code 39 full ASCII	192
code 39 lengths	190
code 39 reduced quiet zone	194
code 39 security level	193
code 39 transmit check digit	191
code 93	197
code 93 lengths	197
composite beep mode	234
composite CC-A/B	231
composite CC-C	231
composite TLC-39	232
continuous bar code read	132
convert code 39 to code 32	188
convert GS1 databar to UPC/EAN	229
convert UPC-E to UPC-A	172
convert UPC-E1 to UPC-A	172
country code page defaults	372
country code pages	376
country codes	357
decode mirror images	137
decode session timeout	134
digimarc	262
digimarc digital watermarks	262
disable all code types	158

discrete 2 of 5	210	maximum characters	279
discrete 2 of 5 lengths	211	MICR E13B	275
EAN zero extend	173	minimum character	278
EAN-13/JAN-13	161	OCR-A	267
EAN-8/JAN-8	160	OCR-A variant	268
enable all code types	158	OCR-B	270
enter	142	OCR-B variant	271
flush macro buffer/abort macro PDF entry	260	orientation	276
FN1 substitution values	146	parameters	267
fuzzy 1D processing	136	quiet zone	280
GS1 databar bar codes	228	redundancy	299
GS1 databar expanded	229	subset	279
GS1 databar limited	228	template	281
GS1 databar limited security level	230	US currency serial number	276
GS1 databar-14	228	parameter scanning	123
GS1-128	181	PDF prioritization	139
GS1-128 emulation mode	234	PDF prioritization timeout	140
I 2 of 5 check digit verification	206	picklist mode	131
I 2 of 5 convert to EAN-13	207	postal	247
I 2 of 5 reduced quiet zone	209	prefix/suffix values	143
I 2 of 5 security level	208	quiet zone level	258
I 2 of 5 transmit check digit	207	reconnect attempt beep	69
ignore code 128 fnc4	185	reconnect attempt interval	69
illumination	141	redundancy level	255
intercharacter gap size	259	report version	259
interleaved 2 of 5	203	samples	352
convert to EAN-13	207, 208	scan data options	144
interleaved 2 of 5 lengths	204	security level	257
inverse 1D	227	set defaults	122
ISBT 128	181	suppress power up beeps	127
ISBT concatenation	182, 183	symbolologies	
ISBT concatenation redundancy	183	default table	152
ISSN EAN	177	timeout between decodes, different symbols	136
Japan postal	249	timeout between decodes, same symbol	135
Korean 3 of 5	226	transmit code 11 check digits	202
matrix 2 of 5	223	transmit code ID character	142
matrix 2 of 5 check digit	225	transmit matrix 2 of 5 check digit	225
matrix 2 of 5 lengths	223, 224	transmit no read message	147
mobile phone/display mode	138	transmit UK postal check digit	249
motion tolerance	142	transmit US postal check digit	248
MSI	217	trigger mode	129
MSI check digit algorithm	221	trioptic code 39	187
MSI check digits	219	UCC coupon extended code	175
MSI lengths	217	UK postal	248
MSI transmit check digit	219	unicode output control	386
Netherlands KIX code	252	unique bar code reporting	133
numeric bar codes	334	unpair	73
OCR		UPC composite mode	233
check digit	290	UPC reduced quiet zone	167
check digit multiplier	291	UPC/EAN	
check digit validation	293	coupon code	175
default table	265	UPC/EAN supplemental AIM ID format	166
inverse OCR	298	UPC/EAN supplemental redundancy	165
lines	278	UPC/EAN supplementals	162

UPC-A	159
UPC-A check digit	167
UPC-A preamble	169
UPC-E	159
UPC-E check digit	168
UPC-E preamble	170
UPC-E1	160
UPC-E1 check digit	168
UPC-E1 preamble	171
UPU FICS postal	253
US planet	247
US postnet	247
USB	
country keyboard types (country codes)	357
USPS 4CB/One Code/Intelligent Mail	252
variable PIN code	63
wi-fi friendly mode	64
barcode defaults	
bluetooth communication	26
barcodes	
aztec	240
aztec inverse	240
bluetooth	
SSI	42
code 128 emulation	236
data matrix	237
data matrix inverse	238
han xin	241
han xin inverse	241
maxicode	238
microPDF417	235
microQR	240
PDF417	235
QR code	239
radio communication	
SSI	42
batch mode stored data	74
battery	
charging	16
Bluetooth	
encryption	64
HID	33
pin code	62
secure simple pairing IO capability	64
SPP	68
bluetooth communication	
defaults	26
bright center dot	20
C	
central serial port profile	68
charging batteries	16
Chinese 2 of 5 bar codes	222
CJK	385
codabar bar codes	213
CLSI editing	215
lengths	213
NOTIS editing	215
start and stop characters	216
code 11 bar codes	199
check digit verification	201
lengths	199
transmit check digit	202
code 128 bar codes	178
GS1-128	181
ignore fnc4	185
ISBT 128	181
ISBT concatenation	182, 183
ISBT concatenation redundancy	183
lengths	179
reduced quiet zone	185
security level	184
code 128 emulation barcodes	236
code 39 bar codes	187
buffering	194, 195
check digit verification	191
code 32 prefix	189
code 39	187
code 39 security Level	193
convert code 39 to code 32	188
full ASCII	192
lengths	190
reduced quiet zone	194
transmit check digit	191
trioptic	187
code 93 bar codes	197
lengths	197
code ID character	142
code identifiers	
AIM code IDs	328
modifier characters	329
Symbol	327
Cold Boot	21
composite bar codes	
beep mode	234
composite CC-A/B	231
composite CC-C	231
composite TLC-39	232
GS1-128 emulation mode	234
UPC composite mode	233
country code page defaults	372
country code pages	376
country codes	357
Cross Hair Lines	20

D

data matrix barcodes	237
default parameters	
bluetooth communication	26
OCR	265
setting	122
standard default table	318
symbolologies	152
digimarc	261
digital watermarks bar codes	262
digimarc digital watermarks	262
discrete 2 of 5 bar codes	210
lengths	211

E

encryption	64
error indications	
miscellaneous scanner options	26
exposure options	
illumination	141

G

getting started	14
GS1 databar	228
GS1 databar bar codes	
convert GS1 databar to UPC/EAN	229
GS1 databar expanded	229
GS1 databar limited	228
GS1 databar limited security level	230
GS1 databar-14	228

I

illumination	141
interleaved 2 of 5 bar codes	203
check digit verification	206
convert to EAN-13	207
lengths	204
reduced quiet zone	209
security level	208
transmit check digit	207

K

keyboard types (country codes)	
Albanian	357
Arabic (101)	357
Arabic (102)	357
Arabic (102) Azerty	358
Azeri (Cyrillic)	358
Azeri (Latin)	358

Belarusian	358
Bosnian (Cyrillic)	358
Bosnian (Latin)	358
Bulgarian (Latin)	358
Bulgarian Cyrillic (Typewriter)	359
Canadian French (Legacy)	359
Canadian French Win7	359
Canadian Multilingual Standard	359
Chinese (ASCII)	359
Croatian	360
Czech	360
Czech (Programmer)	360
Czech (QWERTY)	360
Danish	360
Dutch (Netherlands)	360
Estonian	361
Faeroese	361
Finnish	361
French (Canada) 2000/XP	361
French (Canada) 95/98	361
French (France)	361
French International	361
Galician	362
German	362
Greek	362
Greek (220) Latin	362
Greek (319) Latin	362
Greek 220	362
Greek 319	363
Greek Latin	362
Greek Polytonic	363
Hebrew Israel	363
Hungarian	363
Hungarian_101KEY	363
Irish	363
Islandic	363
Italian	364
Italian (142)	364
Japanese (ASCII)	364
Kazakh	364
Korean (ASCII)	364
Kyrgyz	365
Latin American	365
Latvian	365
Latvian (QWERTY)	365
Lithuanian	365
Lithuanian (IBM)	365
Macedonian (FYROM)	365
Maltese_47KEY	366
Mongolian	366
Norwegian	366
Polish (214)	366
Polish (Programmer)	366
Portuguese (Brazil)	366

Portuguese (Brazilian ABNT)	366
Portuguese (Brazilian ABNT2)	367
Portuguese (Portugal)	367
Romanian	367
Romanian (Legacy)	367
Romanian (Programmer)	367
Romanian (Standard)	367
Russian	368
Russian (Typewriter)	368
Serbian (Cyrillic)	368
Serbian (Latin)	368
Slovak	368
Slovak (QWERTY)	368
Slovenian	368
Spanish	369
Spanish (Variation)	369
Swedish	369
Swiss French	369
Swiss German	369
Tatar	369
Thai (Kedmanee)	369
Turkish F	370
Turkish Q	370
UK English	370
Ukrainian	370
US Dvorak	370
US Dvorak Left	370
US Dvorak Right	370
US English	357
US International	371
Uzbek	371
Vietnamese	371
Korean 3 of 5 bar codes	226
L	
lock override	46
low power mode	68
M	
macro PDF	260
flush buffer/abort PDF entry	260
matrix 2 of 5 bar codes	223
check digit	225
lengths	223, 224
transmit check digit	225
maxicode barcodes	238
MDF	263
microPDF417 barcodes	235
MSI bar codes	217
check digit algorithm	221
check digits	219
lengths	217
transmit check digit	219
multicode data formatting	263
O	
OCR	
default parameters	265
parameters	267
P	
pairing	
bar code format	73
lock override	46
pin codes	62
unpair	73
parameter defaults	
bluetooth communication	26
parameters	
batch mode	74, 76
beep on insertion	124
Bluetooth technology support	33
radio communication	
auto-reconnect interval	68
batch mode	74, 76
reconnect attempt beep	69
reconnect attempt interval	69
unpair	73
PDF417 bar codes	
PDF prioritization	139
PDF417 barcodes	235
PIN code	
static	63
variable	63
postal codes	247
Australia post	250
Australia post format	251
Japan postal	249
Netherlands KIX code	252
transmit UK postal check digit	249
transmit US postal check digit	248
UK postal	248
UPU FICS postal	253
US planet	247
US postnet	247
USPS 4CB/One Code/Intelligent Mail	252
preferred symbol	264
Q	
QR code barcodes	239

R

radio communication	
reconnect attempt	69
reconnect attempt beep	69
reconnect attempt	69
reconnect attempt beep	69
Resetting	21

S

sample bar codes	352
scanning	
errors	120, 151
radio communications sequence example	26
sequence example	120, 151
secure simple pairing IO capability	64
security	
intercharacter gap size	259
quiet zone level	258
redundancy level	255
security level	257
Serial Port Profile	
central	68
setting defaults	122
software tools	
123Scan	23
ADF	263
MDF	263
preferred symbol	264
SPP	
central	68
standard default parameters	318
stored data	
batch mode	74
Symbol Scan Orientation	20
sympology default parameters	152

T

trigger mode	129
Trigger Position	14

U

unicode	
output control	386
unpacking	10
unpairing	
bar code	73
UPC/EAN bar codes	
bookland EAN	161
bookland ISBN	174
check digit	167, 168

convert UPC-E to UPC-A	172
convert UPC-E1 to UPC-A	172
EAN zero extend	173
EAN-13/JAN-13	161
EAN-8/JAN-8	160
ISSN EAN	177
reduced quiet zone	167
supplemental AIM ID format	166
supplemental redundancy	165
supplementals	162
UCC coupon extended code	175
UPC-A	159
UPC-A preamble	169
UPC-E	159
UPC-E preamble	170
UPC-E1	160
UPC-E1 preamble	171
user preferences bar codes	
batch mode	74, 76
beep on insertion	124

W

Warm Boot	21
wi-fi friendly mode	64

