

H-Class™

Operator's Manual ■■■



right by our customers. ■■■



datamax·oneil

Copyright Information

CG Triumvirate is a trademark of Agfa Corporation.

CG Times based upon Times New Roman under license from the Monotype Corporation.

Windows is a registered trademark of the Microsoft Corporation.

Ethernet is a registered trademark of Xerox Corporation.

All other brand and product names are trademarks, service marks, registered trademarks, or registered service marks of their respective companies.

Limitation of Liability

In no event shall Datamax-O'Neil be liable to the purchaser for any indirect, special or consequential damages or lost profits arising out of or relating to Datamax-O'Neil's products, or the performance or a breach thereof, even if Datamax-O'Neil has been advised of the possibility thereof. Datamax-O'Neil's liability, if any, to the purchaser or to the customer of the purchaser hereunder shall in no event exceed the total amounts paid to Datamax-O'Neil hereunder by the purchaser for a defective product.

In no event shall Datamax-O'Neil be liable to the purchaser for any damages resulting from or related to any failure or delay of Datamax-O'Neil in the delivery or installation of the computer hardware, supplies or software or in the performance of any services.

Some states do not permit the exclusion of incidental or consequential damages, and in those states the foregoing limitations may not apply. The warranties here give you specific legal rights, and you may have other legal rights which vary from state to state.

Firmware (Software) Agreement

The enclosed Firmware (Software) resident in the Printer is owned by Licensor or its suppliers and is licensed for use only on a single printer in the user's Trade or Business.

The User agrees not to, and not to authorize or permit any other person or party to duplicate, or copy the Firmware or the information contained in the non-volatile or programmable memory. The firmware (Software) is protected by applicable copyright laws and Licensor retains all rights not expressly granted. In no event will Licensor or its suppliers be liable for any damages or loss, including direct, incidental, economic, special, or consequential damages arising out of the use or inability to use the Firmware (Software).

Information in this document is subject to change without notice and does not represent a commitment on the part of Datamax-O'Neil Corporation. No part of this manual may be reproduced or transmitted in any form or by any means, for any purpose other than the purchaser's personal use, without the expressed written permission of Datamax-O'Neil Corporation.

All rights reserved

Copyright © 2013, Datamax-O'Neil

Part Number 88-2329-01, Revision R

Agency Compliance and Approvals



UL60950-1: 2003 2nd Edition Information Technology Equipment
CSA C22.2 No. 60950-1-07 2nd Edition



The manufacturer declares under sole responsibility that this product conforms to the following standards or other normative documents:

EMC: 2004/108/EC
EN 55022 (2006, A1 :2007) Class B
EN 50024 (1998, A1:2001, A2:2003)

Safety: This product complies with IEC 60950-1, 2nd Edition, 2005-12
ROHS: 2002/95/EC
LVD: 2006/95/EC



Customs Union – Russia, Kazakhstan, Belarus



GB4943.1-2011, GB9254-2008, and GB17625.1-2003



H-4212 and H-6308 models:
The foregoing equipment has been registered under the Clause 3, Article 58-2 of Radio Waves Act

FCC: This device complies with FCC CFR 47 Part 15 Class A.

Note: *This equipment has been tested and found to comply with the limits for a Class A digital device, pursuant to Part 15 of the FCC Rules. These limits are designed to provide reasonable protection against harmful interference when the equipment is operated in a commercial environment. This equipment generates, uses, and can radiate radio frequency energy, and if not installed and used in accordance with the instructions in this manual, it may cause harmful interference to radio communications. Operation of this equipment in a residential area is likely to cause harmful interference in which case the user will be required to correct the interference at their own expense.*

Important Safety Instructions



The exclamation point within an equilateral triangle is intended to alert you to the presence of important operating and maintenance instructions.

This unit has been carefully designed to provide years of safe, reliable performance. As with all electrical equipment, however, there are some basic precautions that you should follow to avoid personal injury or printer damage:

- Before using the printer, carefully read all the installation and operating instructions.
- Observe all warning instruction labels on the printer.
- Install the printer on a flat, firm surface.
- Do not place the printer upon or near a heat source.
- Never insert anything into the ventilation slots and openings of the printer.
- Do not use the printer near water or spill liquid into it.
- Ensure that the AC power source matches the ratings listed for the printer. (If unsure, check with your dealer or local utility provider.)
- Do not step on the AC power cord. If the AC power cord becomes damaged or frayed, replace it immediately.
- If the printer needs repair, consult only qualified, trained service personnel. No user-serviceable parts are inside; do not remove the cover.

Special Instructions



The green check box is intended to alert you to notable details regarding printer operation or to conventions used within this manual.

Applicability

The procedures, functions, and parameters described in this document are written according to an Application Version of printer firmware. To identify the Application Version that corresponds to this text, see Print Configuration in Section 4.3.5. To update the Application Version of your printer, visit our website at www.datamax-oneil.com to download firmware.

Contents

Overview	1
1.1 About the Printer	1
1.1.1 Standard Features	1
1.1.2 Optional Features	3
Getting Started	7
2.1 Unpacking	7
2.1.1 Additional Requirements	8
2.2 Installation	8
2.2.1 Connecting the Power Cord	8
2.2.2 Connecting an Interface Cable	9
2.2.3 Connecting to the SDIO Slot and USB Host Ports.....	10
Setting up the Printer	13
3.1 Media Loading	13
3.1.1 Internal Media Sources	15
3.1.2 External Media Sources	17
3.1.3 Rewinding Media	19
3.2 Media Sensor Adjustment	25
3.3 Ribbon Loading	26
3.4 Quick Calibration	29
3.5 Print Quality Controls	29
Using the Control Panel	31
4.1 Layout	31

4.1.1	The Display	32
4.1.2	Keypad Functions	33
4.2	The System Menu	34
4.2.1	Media Settings	35
4.2.2	Print Control	38
4.2.3	Printer Options	40
4.2.4	System Settings	51
4.2.5	Communications	61
4.2.6	Diagnostics	69
4.2.7	MCL Options	72
4.3	The Test Menu	73
4.3.1	Print Quality Label	73
4.3.2	Ribbon Test Label	74
4.3.3	Test Label	74
4.3.4	Validation Label	74
4.3.5	Print Configuration	75
4.3.6	Print Last Label	75
4.3.7	User-Defined Label	75
	<i>Operating, Adjusting and Maintaining the Printer</i>	<i>77</i>
5.1	Displayed Messages	77
5.1.1	Prompts and Condition Messages	77
5.2	Calibration	80
5.2.1	Standard Calibration	80
5.2.2	Advanced Entry Calibration	82

5.3	Reset Methods	89
5.3.1	Soft Reset	89
5.3.2	Level One Reset	90
5.3.3	Level Two Reset	90
5.4	Printhead Assembly Adjustments	90
5.4.1	Leveling Cam Adjustment	90
5.4.2	Printhead Pressure Adjustment.....	92
5.5	Maintenance	92
5.5.1	Cleaning the Printhead	94
5.5.2	Cleaning the Fan Filter	96
5.5.3	Cleaning the Interior Compartment	96
5.5.4	Cleaning the Media Sensing Components	97
5.5.5	Cleaning the Platen and Assist Rollers.....	97
5.5.6	Cleaning the Ribbon Path Components.....	98
5.5.7	Cleaning the Exterior Surfaces.....	100
5.6	Updating the Firmware	100
5.7	Updating the Boot Loader	101
5.8	Downloading Fonts	102
5.9	Replacing the Printhead.....	105
	<i>Troubleshooting</i>	107
6.1	Problem Resolution	107
6.1.1	General Resolutions	107
6.1.2	Warning and Fault Messages	111
6.2	Hex Dump Mode.....	117

Specifications.....	119
7.1 General.....	119
7.2 Model-Specific Specifications.....	120
7.3 Approved Media and Ribbon.....	130
Appendix A.....	133
Module Assignments, and File Handling Definitions and Messages	133
Appendix B.....	137
Resolutions, Widths, Speeds, Emulations, & Custom Adjustments	137
Appendix C.....	141
RS-422/485 Port Configuration	141
Appendix D	143
Changing the Menu Language	143
Appendix E.....	147
Saving a Configuration File	147
Appendix F.....	149
Ethernet Setup	149
Appendix G.....	153
Printer Driver and Port Setup	153
Glossary.....	167

1 Overview



1.1 About the Printer

Congratulations on your purchase of an H-Class printer (hereafter referred to as “the printer”). This manual provides information regarding printer setup, operation, and care.

To print label formats, refer to the instructions provided with your labeling software; or, if you wish to write custom programs, a copy of the *Class Series 2 Programmer's Manual* can be found on the Accessories CD-ROM and at our web site at <http://www.datamax-oneil.com>

As detailed below, available standard and optional features can meet all of your labeling requirements.

1.1.1 Standard Features

Depending upon the model and type, the printer offers the following standard features:

Feature	Model and Type		
	H-4xxx Standard	H-6xxx Standard	H-xxxxX Tall
Control Panel Security	X	X	X
Default Configuration Restorable	X	X	X
Diagnostic Display and Modes	X	X	X
Die Cast Media Hub	N/A	N/A	X

Feature <i>(continued)</i>	Model and Type		
	H-4xxx Standard	H-6xxx Standard	H-xxxxX Tall
Direct Thermal Printing	X	X	X
Downloadable Firmware Upgrades	X	X	X
DRAM Memory (MB)	16	16	16
EFIGS Multi-Language Support	X	X	X
Ethernet LAN	X	X	X
Fault Handling with Reprint & Void	X	X	X
Flash Memory (MB)	8	8	8
Graphics Display (128 x 64 pixels)	X	X	N/A
Graphics Display (240 X 320 pixels)	Optional	Optional	X
Host-Accessible Memory	X	X	X
IEEE 1284 Compliant Parallel Interface	X	X	X
IntelliSEAQ Printhead	X	X	X
Internal Test & Configuration Labels	X	X	X
Label Retract Control after Print	X	X	X
Line Mode (ASCII Text Input) Printing	X	X	X
Media Counters	X	X	X
Media Tear Bar	X	X	X
Option Hardware Auto-Detection	X	X	X
On-Demand and Batch Printing	X	X	X
Power-up Diagnostics	X	X	X
Resident Multiple Setup and Restore	X	X	X
Resident Option Hardware Diagnostics	X	X	X
RFID Upgrade Availability	X	X	X
Ribbon Low Detection and Warning	X	X	X
Scalable Font Engine	X	X	X
SDIO Interface (internal remote)	Optional	X	X
Serial RS-232/422 Interface	X	X	X
Text, Bar Code, Graphics, and Image Printing	X	X	X
Three-Inch Media Hub	X	X	X
Time and Date Battery Backup	X	X	X
Time Stamping	X	X	X
USB (device) Interface, Version 2.0	X	X	X
USB Host Ports (2) (internal remote)	Optional	X	X

1.1.2 Optional Features *(available except as noted)*

The following optional features are offered for the printer:

40 mm Media Hub *(H-4xxx and H-4xxxX models only)*

A media hub that accommodates 40-millimeter cores.

DMXrfNetII

A WiFi Ethernet card with many features, including:

- 802.11b WiFi LAN standards-based technology

- Integrated module with radio, baseband, MAC, and application processors

- Built-in TCP/IP and UDP for flexible LAN connectivity options

- Built-in Web server for drop-in LAN and internet connectivity

- Built in WEP security protocol

- Integrated command interface that eliminates complicated software drivers

External Media Rewinders

Precision-crafted, bi-directional rewinding mechanisms with device-dependant features:

- DMXREW1 - accepts 1 to 4 inch (25 to 101 mm) diameter core that is up to 4.5 inches wide (114 mm), and rewinds to an 8-inch (203 mm) maximum outer diameter at 10 inches per second.

- DMXREW2 - accepts a 3-inch (76 mm) diameter core that is up to 9.5 inches wide (241 mm), and rewinds to a 12-inch (304 mm) maximum outer diameter at 30 inches per second.

ILPC Fonts

Font sets that allow International Language Print Capability, consisting of one of the following:

- CG-Times (western European) Scalable

- Kanji Gothic B Scalable

- Simplified Chinese GB Scalable

- Korean Hangeul

Internal Rewinder, Power-Assisted *(Standard models only)*

An internal mechanism to wind printed labels, or backing material when using a Peel and Present option, into a maximum outer diameter roll of five and half inches (139 mm).

Internal Rewinder, Powered "Full Roll" *(Tall models only)*

A motorized internal mechanism to wind printed labels, or pull the backing material when using a Peel and Present option, into to a maximum outer diameter roll of eight inches (203 mm).

Linear Scanner *(H-4xxx and H-4xxxX models only)*

A CCD scanning device with data capture and integrated label voiding features to ensure the integrity of printed bar codes.

Media Cutter

A rotary-type device that cuts material with a maximum thickness of .01 inch (.254 mm) into lengths as small as 1.25 inches (31.8 mm).

Peel and Present Mechanism, High Performance

(H-4xxx and H-4xxxX models only, Internal Rewind optional)

A device that peels labels with aggressive adhesives from the backing material for immediate application, regulated by previous label removal (Minimum label length is 1.5 inches [38 mm]).

Peel and Present Mechanism, Standard *(Internal Rewind required)*

A device that peels labels from the backing material for immediate application, regulated by previous label removal (Minimum label length is 1.5 inches [38 mm]).

Present Sensor

An output regulator that inhibits printing when a label is presented.

RFID *(All models except H-8308X)*

An integrated Ultra High Frequency (UHF) RFID encoding and reading device with data capture, available in three different configurations:

Factory Installed - complete, ready to use from the factory.

Ready - factory installed antenna, requiring installation of a module and hardware.

Full Upgrade - antenna, RFID module, and hardware require installation.

SDIO Interface and USB Host Ports

Interface ports that allow the printer to accept external SDIO and USB memory devices for storing graphics, label formats, fonts, and firmware; and that allow USB keyboard connections (and USB scanning device connections for MCL users) for direct data input applications.

Thermal Transfer

A hub assembly that allows printing with ribbon for exceptional image clarity and durability, as compared to most direct thermal media types.

Option Installation

The table below lists the experience needed to install the options described above. For more information, contact your dealer or Datamax-O'Neil.

Option Installation	
Option	Recommended Installer
40 mm Media Hub	Factory only
Cover Dampener	DMX Certified Technician
External Media Rewinder	Operator
Graphics Display	DMX Certified Technician
ILPC Fonts	DMX Certified Technician
Internal Rewinder	Operator
Linear Scanner	DMX Certified Technician
Media Cutter	Operator
Peel and Present Mechanism	Operator
Present Sensor	Operator
RFID (Ready and Full Upgrade)	DMX Certified Technician
SDIO Interface and USB Host Ports	DMX Certified Technician
Thermal Transfer	Operator

2 *Getting Started*

2.1 Unpacking

The printer has been carefully packaged to prevent transit damage. (Inspect the container for damage and, if evident, notify the shipping company before acceptance.)

After removing the packaging, check the contents of the shipment.

The following items are included:

- Printer
- Power Cord
- Quick Start Guide
- Accessories CD-ROM
- Warranty Card
- Any special or additionally purchased items



Save the carton and packing material for future use.

2.1.1 Additional Requirements

Other items can also be needed for operation:

- An interface cable (see Section 2.2.2);
- Applicable media (see Section 7.3); and,
- Applicable software (consult the Accessories CD-ROM, your dealer, or Datamax-O'Neil).

2.2 Installation

The printer features an auto-ranging power supply and several different interface types for easy installation.



Ensure that the Power Switch is OFF when making printer connections.

2.2.1 Connecting the Power Cord

With printer placed upon a firm and level surface, connect the Power Cord as follows:

- Ensure that the Power Switch is turned OFF.
- Connect the Power Cord to the AC receptacle on the printer, and then to a properly rated and grounded AC outlet.



2.2.2 Connecting an Interface Cable

The printer can be interfaced to a host device via Ethernet, Parallel, Serial, and USB ports. Following power-up (or after inactivity), interface port selection occurs automatically upon detection of valid data. If incoming data flow stops as the Host Timeout period (see Section 4.2.5) is met, partially received formats will be ignored and the port selection repeated.



- To change an active port immediately, cycle the power OFF and ON.
 - For alternate data processing options, see *INPUT MODE*, Section 4.2.4.
-

Ethernet Connection

The Ethernet interface supports several menu-selectable modes. Depending on the length, the cable should be Category / Type 3 or better. Refer to Appendix F for setup information.

Parallel Connection

The parallel interface supports directional communications. Choose and connect cabling as follows:

- For unidirectional communication, use a Centronics IEEE 1284 cable with a 36-pin male connector; or,
- For bi-directional communication, use an IEEE 1284 Compliant cable with a 36-pin male connector (and supporting host software).



Serial Connection

The serial interface supports RS-232C, RS-422, and RS-485 communications (see Appendix C for RS-422/485 details).

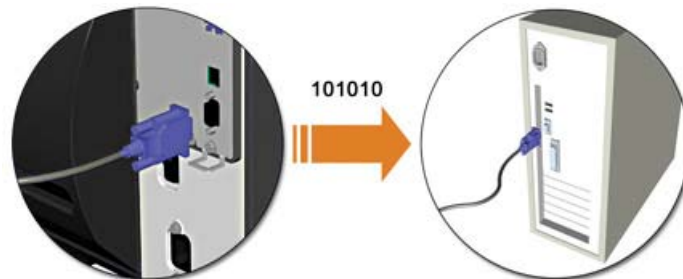

RS-232C cabling configurations and part numbers are shown below (contact your reseller for ordering information).

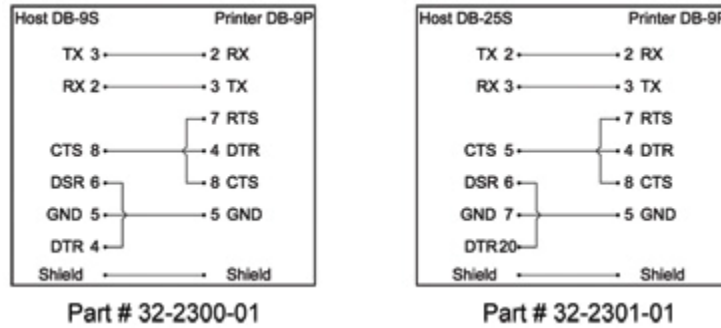

USB Connection

The USB interface connection may differ slightly depending upon the operating system and hardware configuration of the host computer. Basic connections are shown below.

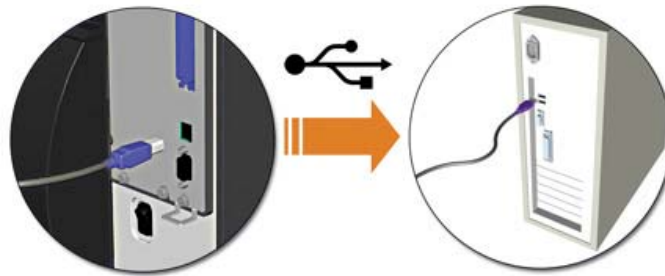

2.2.3 Connecting to the SDIO Slot and USB Host Ports

If equipped with the Secure Digital Input Output (SDIO) and USB Host Ports, the printer can accept external storage devices for fonts, graphics, label formats, and firmware files. The USB Host Port also accepts a USB keyboard for standalone, direct data (Line mode) input applications; see the *Class Series 2 Programmer's Manual* for examples.

SDIO Connections - When installing an SDIO Card, turn OFF the printer then slide the card into the slot. Module "F" will be recognized by the printer. When removing a card, turn OFF the printer then press inward on the card to release it.

USB Host Port Connections - The USB Host Ports support plug and play device installation and removal. Module "H" and Module "I" will be recognized by the printer.

-
-  • Memory device sizes up to 16 GB are supported.
 - If equipped on the memory device, ensure that the Write Protect Switch is OFF.
 - Before initial use, format the external memory device; see Section 4.2.3.
 - Always allow process completion before removing modules.
-

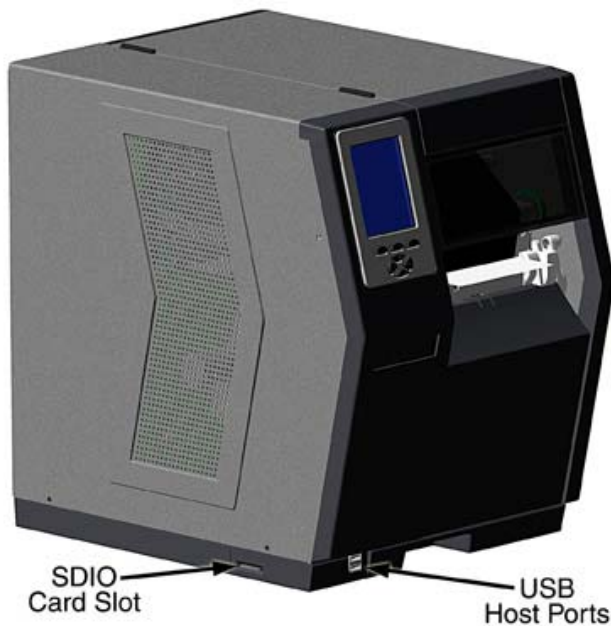

Using Memory Functions

Download your files to the device using Windows Explorer or DMX Config; see FILE HANDLING DEFINITIONS in Appendix A. The following examples highlight several ways to use memory devices; unless otherwise noted, see MODULES in Section 4.2.3 for details about function selections.



- Files that reside in Module "X" cannot be copied; see Appendix A for module details.
- For access to all functions, ensure that the Advanced Menu is selected: Press **System Settings** select **Menu Mode** and then **Advanced Menu**.

- To copy files stored on a module to or from the printer:
1. Press the **MENU** button then select **Printer Options**.
 2. Select **Modules** and then **Copy File**.
 3. Select the file to copy and then the destination module ID.



When sharing configuration files between printers, use **Restore As Current** (see **CONFIGURATION FILE**, Section 4.2.4) and perform calibration (see Section 5.2).

- To copy firmware stored on a module to the printer:
 1. Press the **TEST** button then select **User Defined Label**.
 2. Select the module ID and the firmware file.

- To print files stored on a module:
 1. Press the **TEST** button and then select **User Defined Label**.
 2. Select the module ID then the file to print.



To print directly from stored files at power-up, see User Label Mode in Section 4.2.4.

- To print a previous label format that is stored in memory:
 1. Press the **MENU** button then select **Printer Options**.
 2. Select **Modules** and then **Print File**.

3 *Setting up the Printer*

3.1 *Media Loading*

Load media according to its type and source, after performing these prerequisites:

- A. Raise the cover.
- B. Rotate the Printhead Latch counterclockwise then raise the Printhead Assembly.

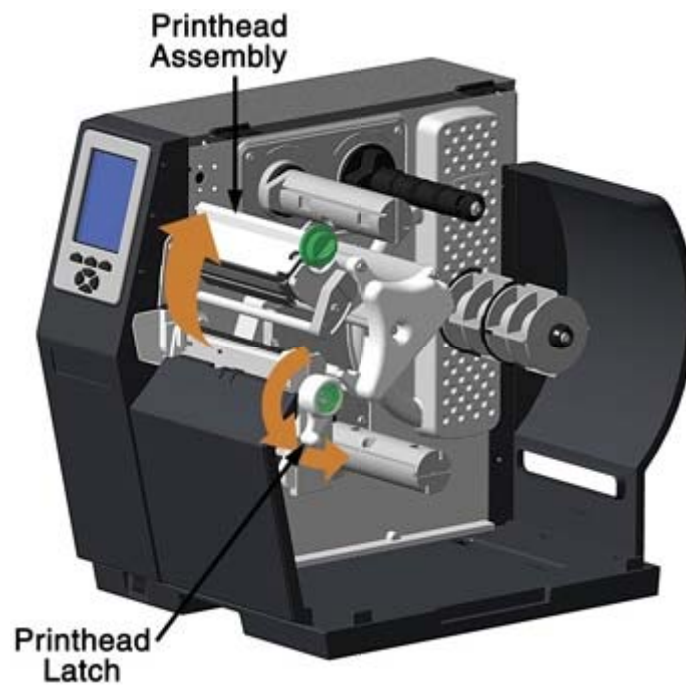

C. Slide the Media Guide outward.

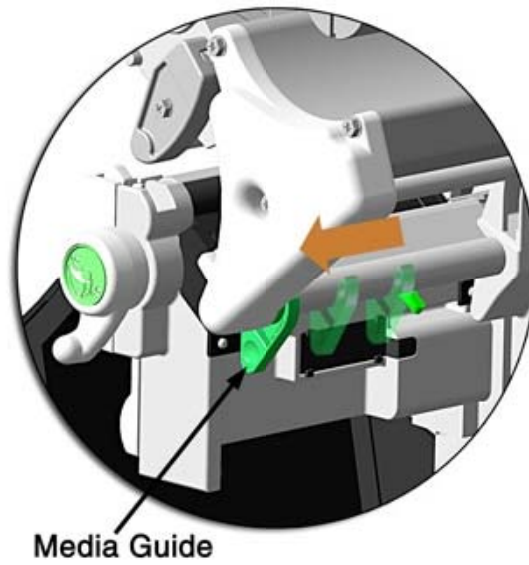

D. Rotate the Media Guide upward.

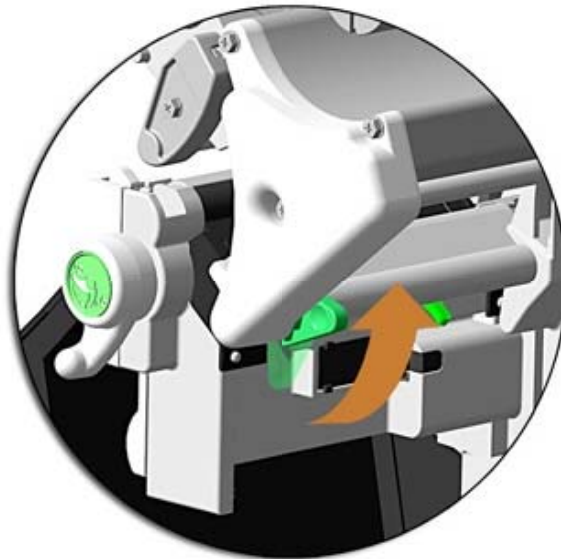

E. Proceed according to the source of the media being installed:

- If using internally supplied (roll media) sources, see Section 3.1.1; or,
- If using externally supplied sources (e.g., boxed fanfold stock), see Section 3.1.2.

3.1.1 *Internal Media Sources*

- A. Slide Roll Media completely onto the Media Hub.

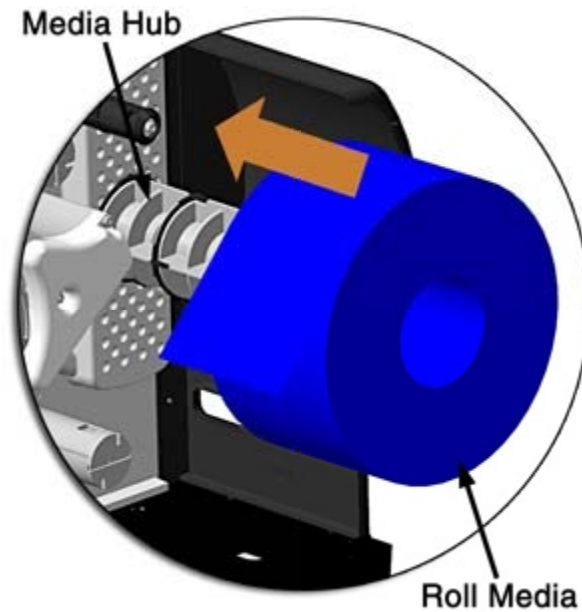

- B. Route the media under the Media Guide Extrusion then out the front of the printer, as shown.

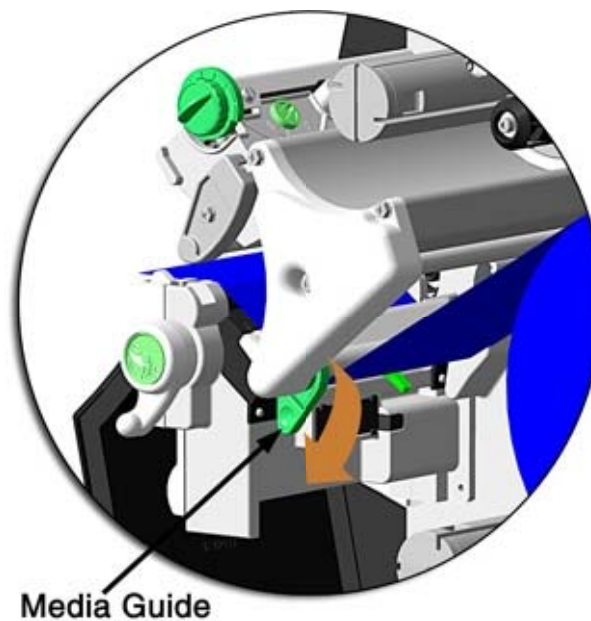

- C. Rotate the Media Guide into the DOWN position and then slide the guide inward until it rests lightly against the edge of the media.

- D. If loading media for the first time, or if switching media types, widths, or configurations, position the Media Sensor as detailed in Section 3.2; otherwise, go to Step E.



If loading thermal transfer media, also load ribbon; see Section 3.3.

- E. Lower the Printhead Assembly then rotate the Printhead Latch completely clockwise.

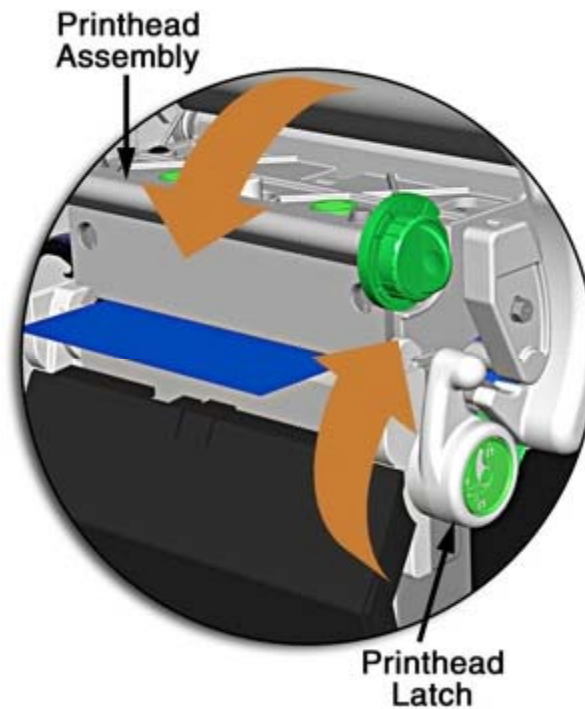

- F. Close the cover. With READY displayed, press and hold the FEED Key until at least one gap (or mark) advances; see Section 3.4.



If your media is less than the width of the printhead, adjust the Leveling Cam; see Section 5.4.1.

3.1.2 External Media Sources

- A. Place the media supply (box or roll) parallel to and in-line with the Rear Media Loading Slot or Bottom Media Loading Slot, in a position that will not cause the media to twist or turn as it feeds from the source.



If loading reflective media, be sure that the material enters the printer with the black marks facing down.

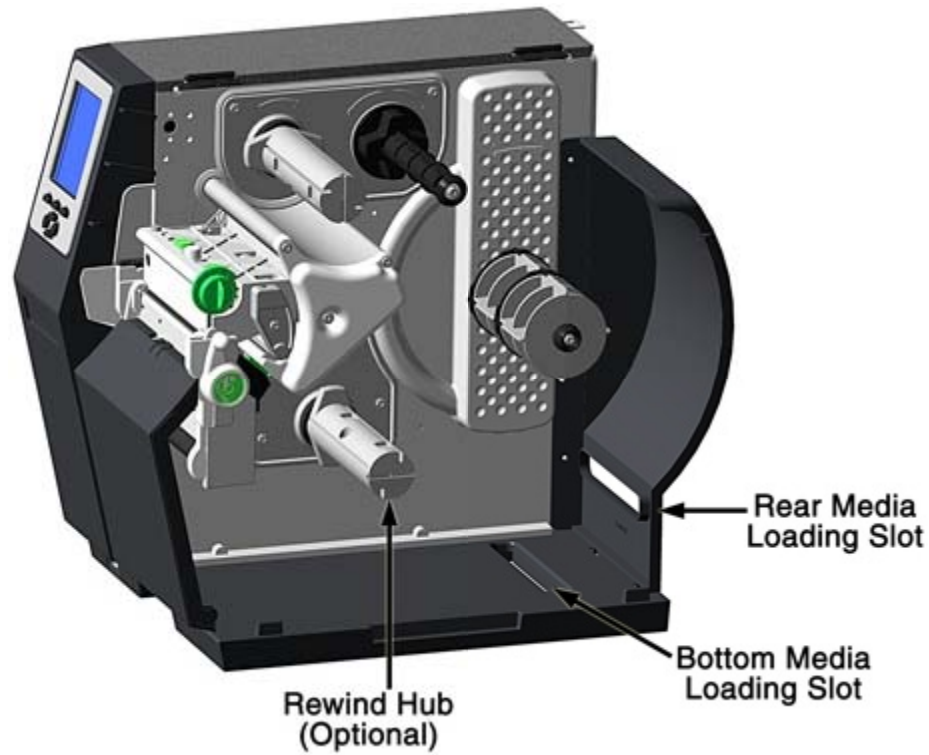

- B. Route the media into the printer through the Rear Media Loading Slot or Bottom Media Loading Slot, and if equipped over the Rewind Hub.
- C. Route the media under the Media Guide Extrusion then out of the printer, as shown in the previous section.
- D. Rotate the Media Guide into the DOWN position and then slide the guide inward until it rests lightly against the edge of the media, as shown in the previous section.

- E. If loading media for the first time, or when switching media types, widths, or configurations, position the Media Sensor as detailed in Section 3.2; otherwise, go to Step F.

 *If loading thermal transfer media, also load ribbon; see Section 3.3.*

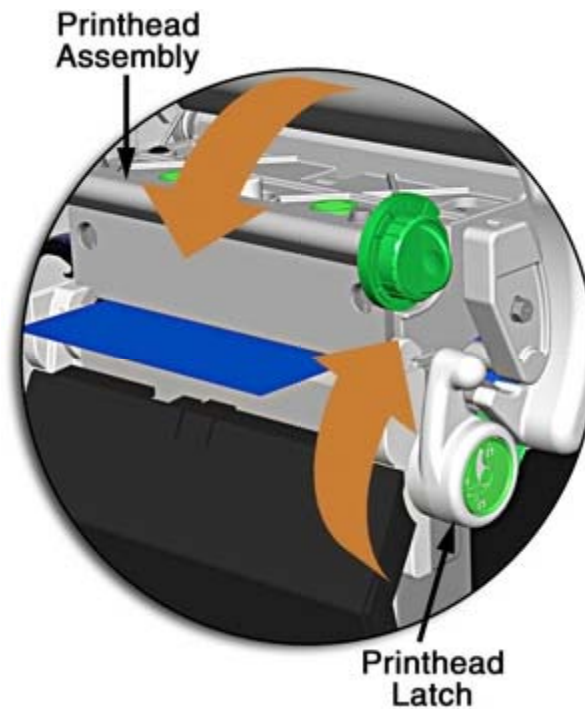

- F. Lower the Printhead Assembly then rotate the Printhead Latch completely clockwise.
- G. Close the cover. With READY displayed, press and hold the FEED Key until at least one gap (or mark) advances; see Section 3.4.

 *If your media is less than the width of the printhead, adjust the Leveling Cam; see Section 5.4.1.*

3.1.3 *Rewinding Media*

When equipped with the Internal Rewind option, outputs can be rewound or, with the addition of a Peel and Present option, dispensed automatically for application. If equipped, follow the instructions below to begin using the Internal Rewinder:

- A. Press down on the Tab then pull outward to remove the Front Fascia.

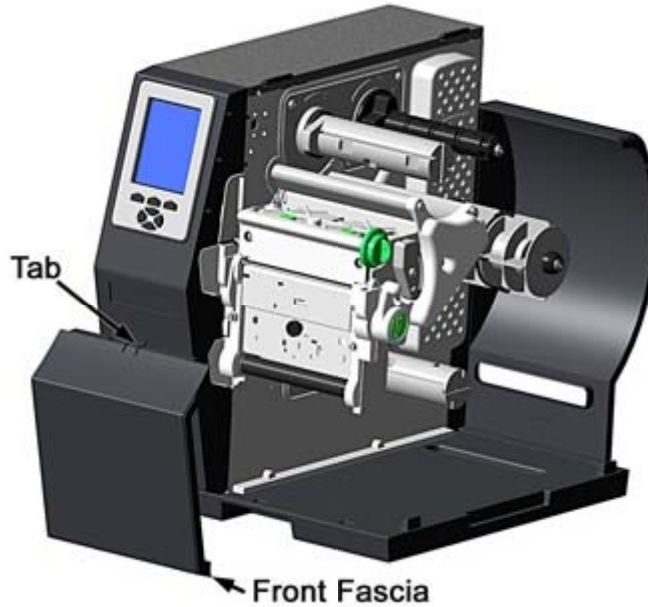

- B. Remove Thumbscrew and Tear Plate.

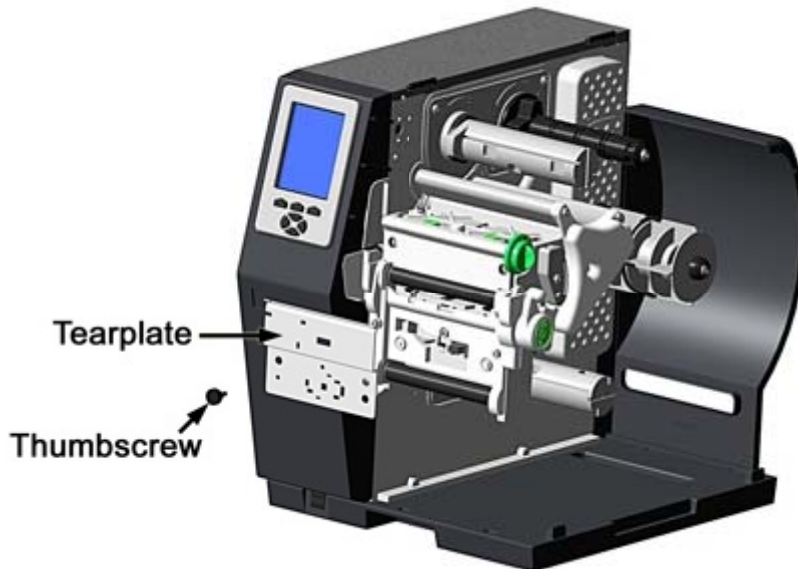

- C. Place the Arcplate on the front of the printer (as shown below) and tighten the Phillips Head Screw to secure it; or, to use the Peel and Present option attach that device.

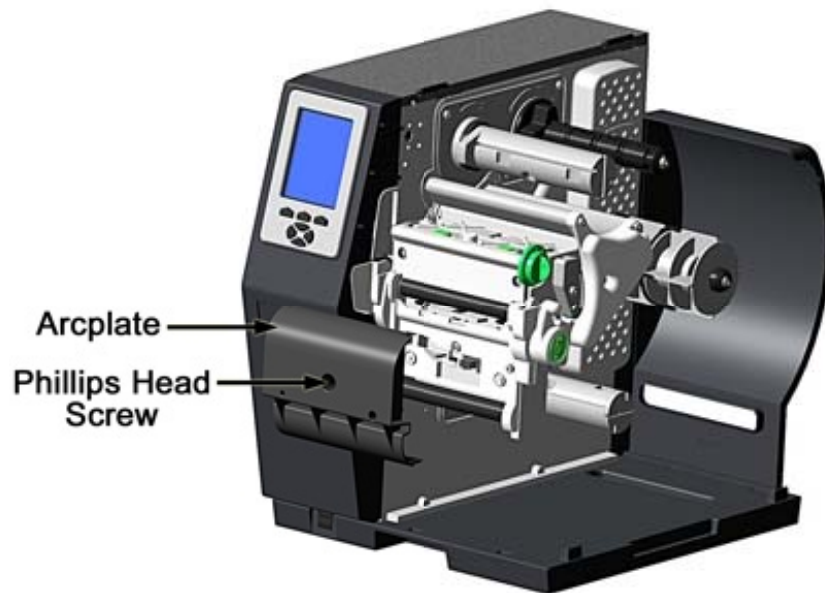

- D. Proceed according to your application:

- To rewind labels onto an empty media core (tall models only), go to Step E.
- To dispense labels using a Peel and Present option, refer to the instructions included with that option.

- E. H-8308X users (all others go to Step F), rotate the latch 1/4 turn counterclockwise to release the Rewind Support from the Rewind Hub then swing the Rewind Support outward.

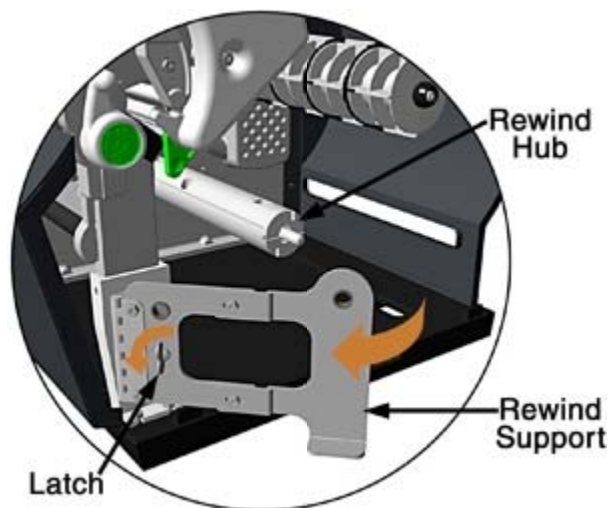

- F. Align the Tabs on the Rewind Core Adapter to the Slots in the hub, and then slide the Rewind Core Adapter onto the middle of the hub.

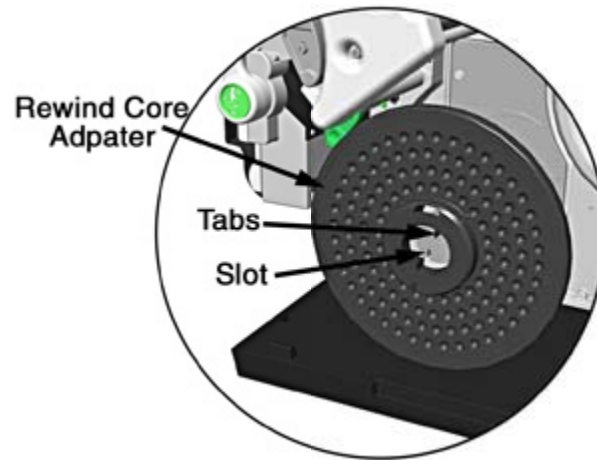

- G. Grasp the end of the hub and, while pulling outward, squeeze the hub together until it collapses then slide Rewind Core Adapter toward the Centerplate until it locks in place.

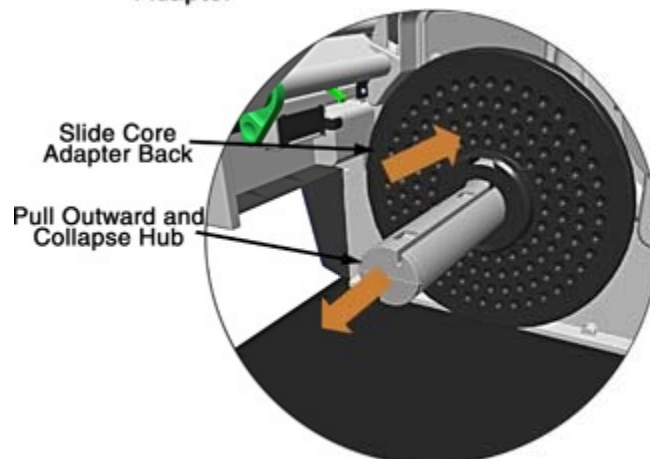
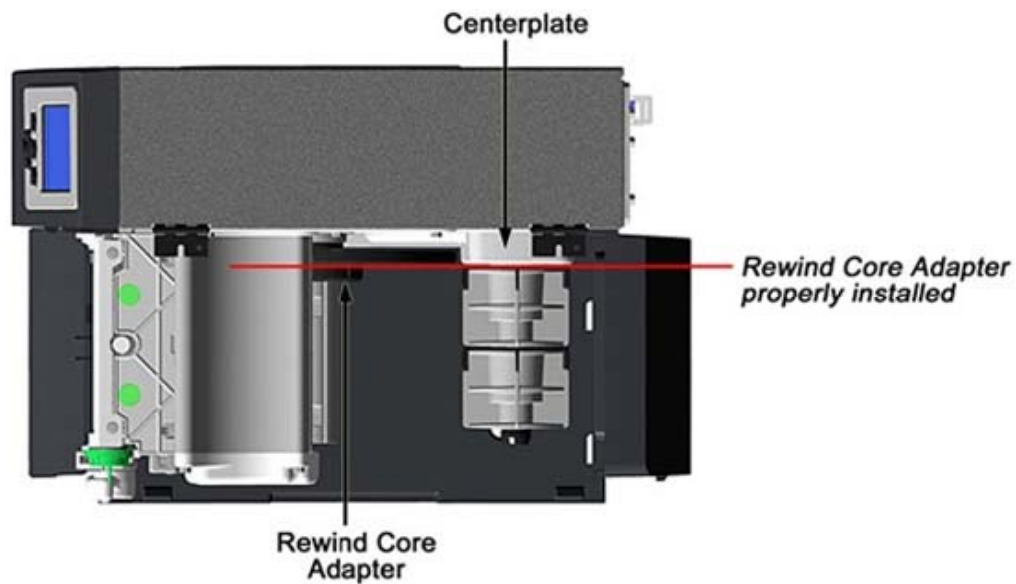

H. Slide an Empty Media Core (3" diameter) onto the Rewind Core Adapter.

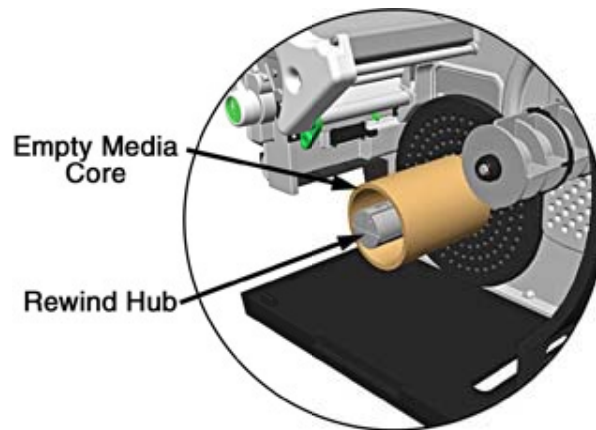

I. Slide the Rewind Retainer into the Empty Media Core then close the Locking Lever.

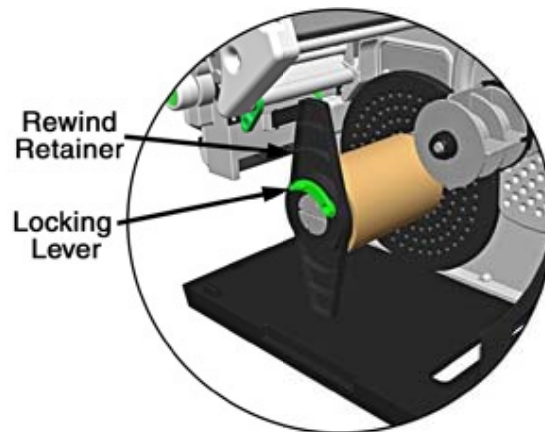

J. H-8308X users (all others go to Step K), close the Rewind Support then rotate the latch 1/4 turn clockwise to lock the Rewind Support.

K. With label stock installed as described in Loading Roll Media, repeatedly press the FEED Key until about 20 inches (50 cm) of media has been output.

- L. Route the media back into the printer and around the media core (as shown below) then tape the leading edge to the media core. Rotate the Hub by hand to take up any slack in the media. There should be at least 2 or 3 full wraps of the media on the empty core before starting printing to ensure tight rewinded rolls.

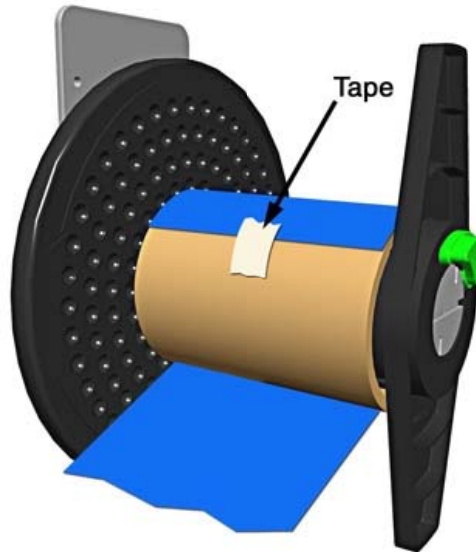

- M. Enter the menu, go to **PRINTER OPTIONS / REWINDER**, and select **Enable**. Exit the menu and save your changes. (The rewinder will turn slowly for about 30 seconds to tension the material and afterward rotate as labels are advanced.)



If dispensing narrow or small labels using a Peel and Present option, the following settings may require adjustment:

- *To maintain Top Of Form accuracy, it may be necessary (depending upon the print speed) to reduce the torque; see **PRINTER OPTIONS / REWINDER ADJUSTMENT**.*
- *To maintain image sizing accuracy, it may be necessary to adjust **CUSTOM ADJUSTMENTS / ROW ADJUST** to a negative value.*

For example, while peeling 2 inch wide by 1 inch long labels using an H-8308, the following settings were used to maintain accuracies; your results may vary:

<i>Print Speed (IPS)</i>	<i>Rewinder Adjustment</i>	<i>Row Adjust</i>
<i>2</i>	<i>-30%</i>	<i>-40 Dots</i>
<i>4</i>	<i>-20%</i>	
<i>6</i>	<i>-10%</i>	
<i>8</i>	<i>-10%</i>	

Unloading the Internal Rewinder

To unload the Internal Rewinder, open the Locking Lever, remove the Rewind Retainer, and slip the roll of labels (and core) off the Rewind Core Adapter.

Removing the Adapter Core

To switch from label rewinding to label peeling, remove the Rewind Core Adapter as follows:

- A. Remove labels from the Internal Rewinder. Open the Rewind Support (8" wide models only).

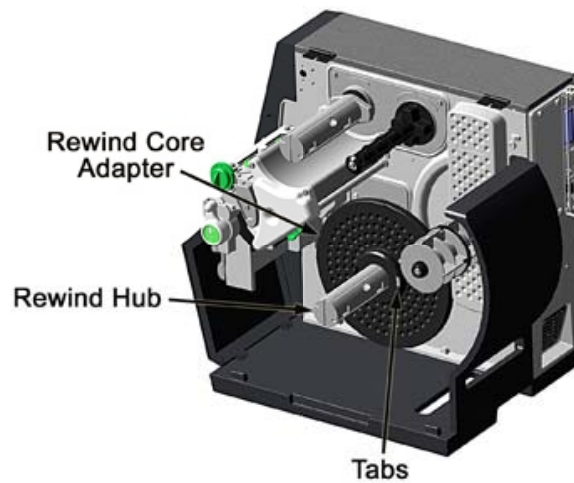

- B. Rotate the Rewind Hub so that the Tabs are in a horizontal position, as shown.

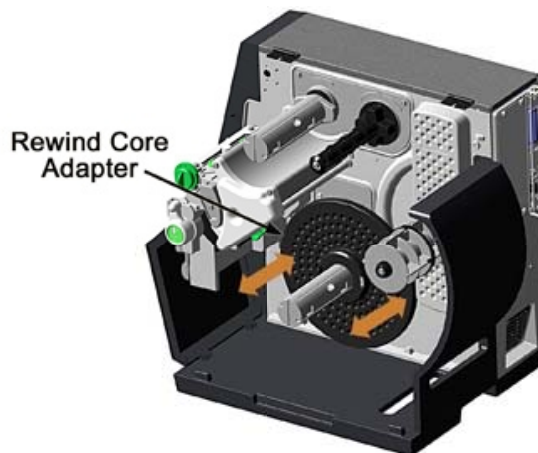

- C. Using both hands, grasp the Rewind Core Adapter and, with a gentle back-and-forth rocking motion, pull the Rewind Core Adapter off the Rewind Hub.

3.2 Media Sensor Adjustment

Position the Media Sensor for proper label detection:

- A. Raise the Printhead Assembly. Note the Red Dot (see illustration below) that identifies the location of the Media Sensor.
- B. Grasp the Slide Tab to position the Red Dot according to the Media Type, as detailed below.

Media Sensor Adjustment	
Media Type	Red Dot Position
Die-cut	Centered over a label
Notched	Centered over a notch
Reflective	Centered over a black mark
Continuous	Centered over the material

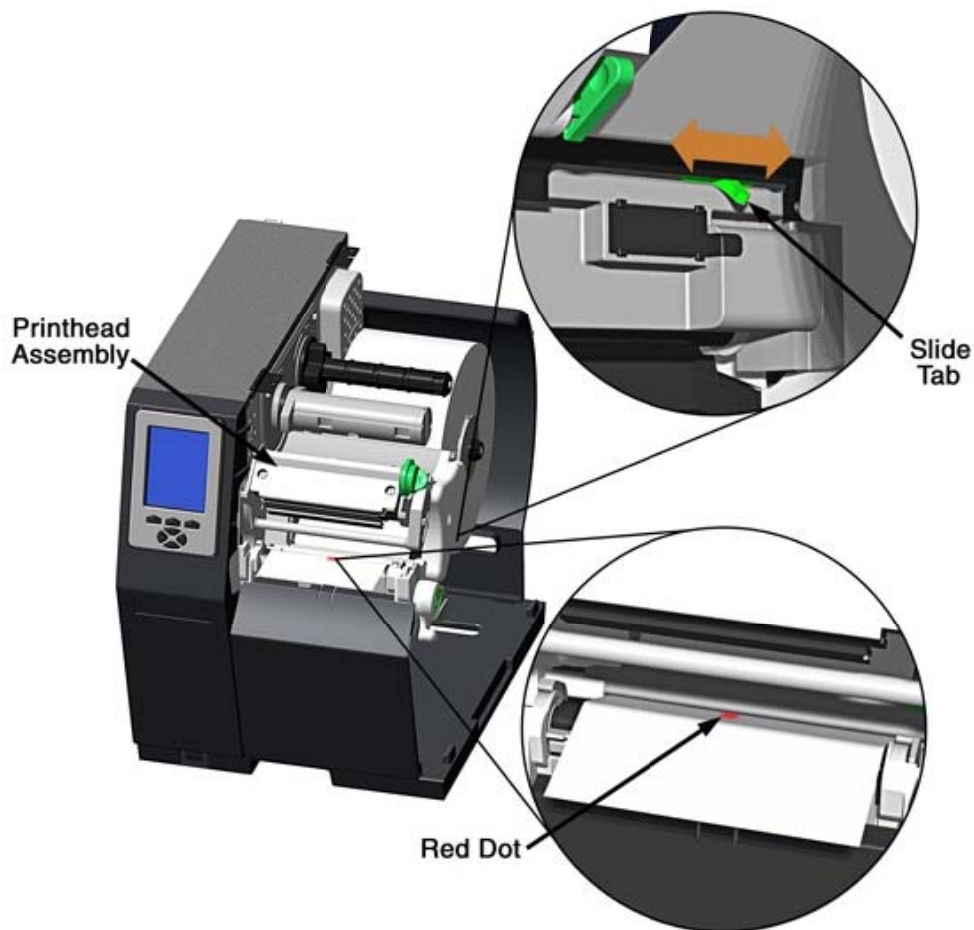

- C. Lower the Printhead Assembly then rotate the Printhead Latch completely clockwise.
- D. If necessary, return to Media Loading to complete the setup process; otherwise, close the cover. With READY displayed, press and hold the FEED Key until at least one gap (or mark) advances; see Section 3.4.



If using REFLECTIVE or CONTINUOUS media, select the appropriate SENSOR TYPE; see Section 4.2.1.

3.3 Ribbon Loading

Ribbon, required when printing on thermal transfer media, should be loaded as follows:



The use of ribbon slightly wider than the media (and liner, if any) is recommended to help protect against abrasive wear.

- A. Rotate the Printhead Latch counterclockwise then raise the Printhead Assembly.

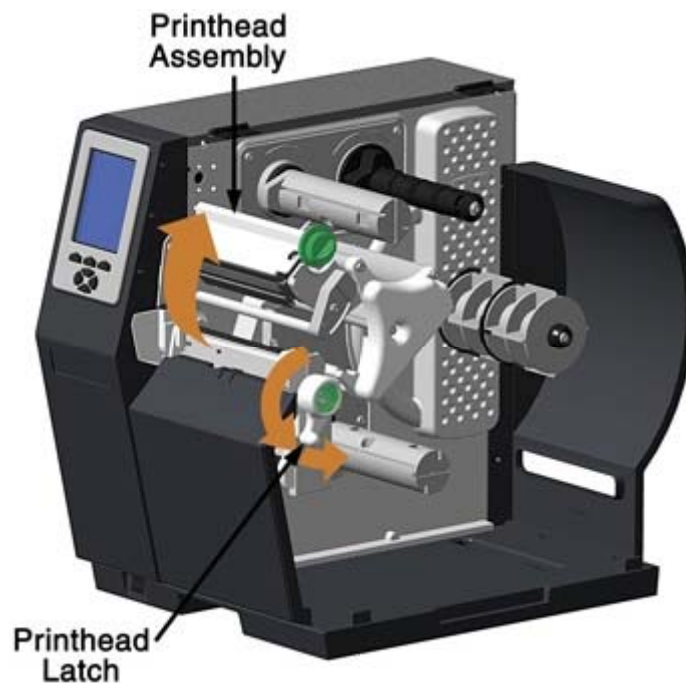

- B. In the direction appropriate for the ribbon type being installed (Coated Side In or Coated Side Out), slide a Ribbon Roll completely onto the Ribbon Supply Hub, as shown below.



The coated (inked) side of the ribbon must face the media.

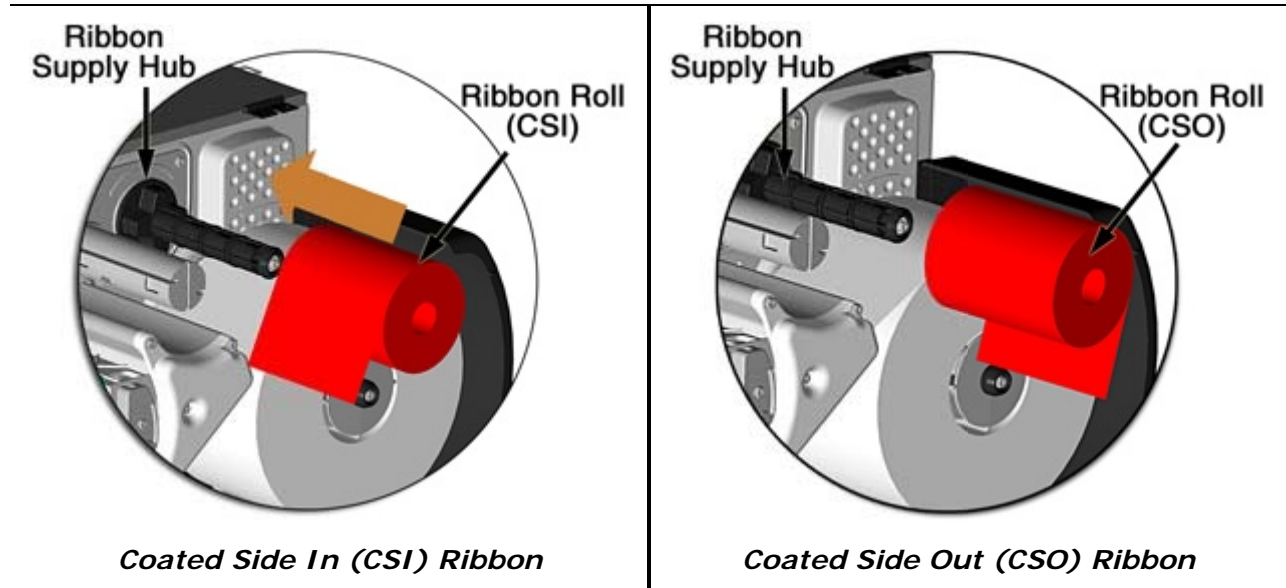

- C. Route the ribbon under the Ribbon Idler then out the front of the printer.

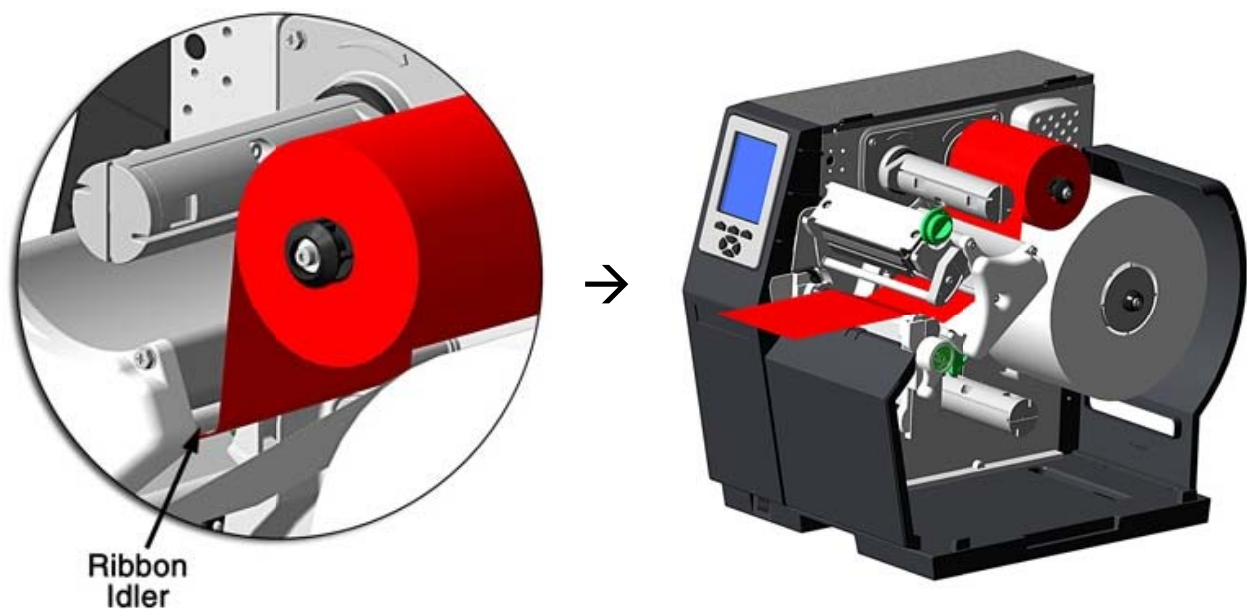

- D. Route the ribbon up and around the Ribbon Take-Up Hub. Wrap the ribbon several times clockwise (as indicated by the directional arrows) around the hub to secure it.

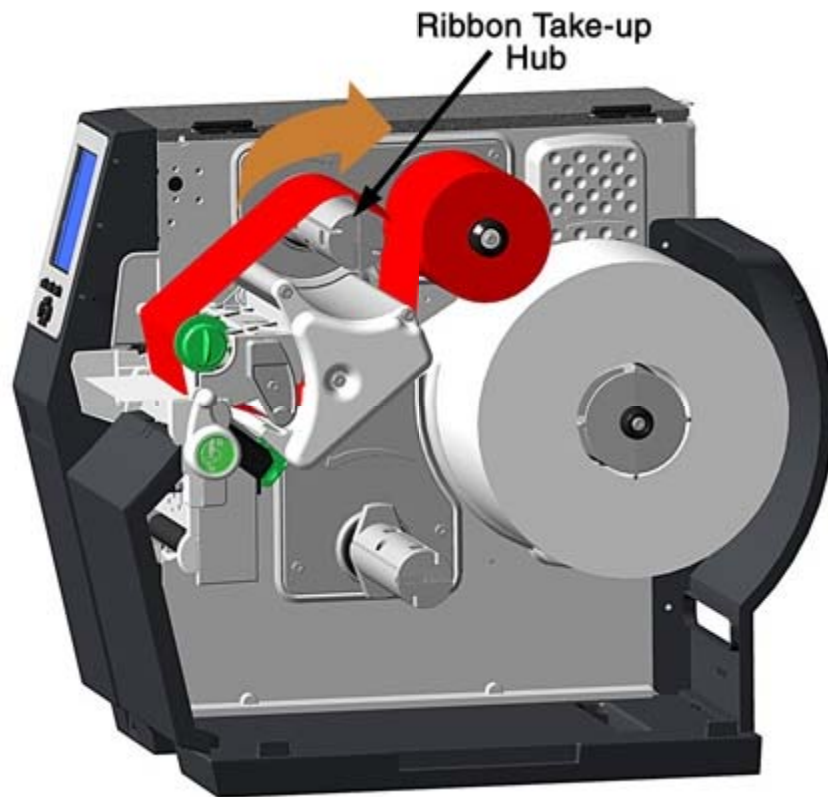

- E. Lower the Printhead Assembly then rotate the Printhead Latch completely clockwise.
- F. Close the cover. With READY displayed, press and hold the FEED Key until at least one gap (or mark) advances; see Section 3.4.



Remove used ribbon when the Ribbon Roll is depleted: Pull the empty core from the Ribbon Supply Hub. Grasp the used roll on Ribbon Take-Up Hub then pull and squeeze to remove the spent ribbon. (To remove partially depleted rolls, cut the ribbon then remove the roll as described above and discard any used ribbon.)

3.4 Quick Calibration

Quick Calibration fine-tunes the printer for your media and should be performed during initial setup or after switching media. With media installed and the sensor position adjusted, perform calibration as follows:

With the printer idle, press and hold the FEED Key until one complete label advances and then release the key.

Upon successful completion, CALIBRATION COMPLETED will be displayed followed by READY.



- *If the printer displays CANNOT CALIBRATE or stops feeding mid-label, press and hold the FEED Key until two (or more) labels are advanced before releasing the key. If this method also fails, see Media Sensor Calibration (Section 5.2).*
 - *WARNING LOW BACKING may appear if using notched media, or media with a transparent liner; however, calibration was successful.*
 - *Media containing large gaps may require a change in the PAPER EMPTY DISTANCE; see Section 4.2.1.*
-

3.5 Print Quality Controls

The printer provides flexible print controls. Of these, the amount of heat applied and the rate of media movement will have the most effect on the printed output. Four settings are available via PRINT CONTROL (see Section 4.2.2):

- HEAT sets the printing energy level, where lower amounts lighten the image and higher amounts darken it;
- PRINT SPEED adjusts throughput, where slow speeds allow more time for energy transfer and fast speeds may require more HEAT to achieve the desired contrast;
- CONTRAST fine-tunes the gray (shaded) areas of the image; and,
- DARKNESS fine-tunes the black areas of the image.



Heat and Speed commands from the host software may override the printer's menu setting; see HOST SETTINGS, Section 4.2.5.

4 Using the Control Panel

4.1 Layout

The Control Panel is an event-driven user interface composed of a graphics display and keypad. Depending upon the size, the display layout and composition differs:

Small Display

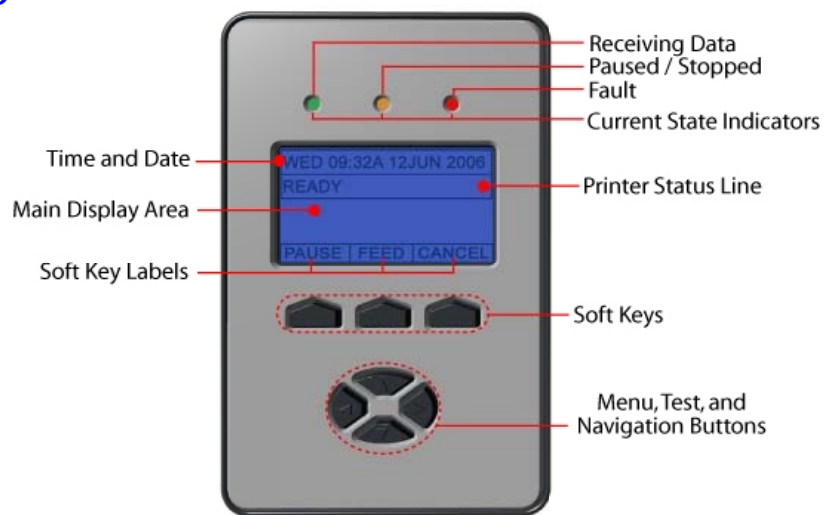

Large Display



4.1.1 The Display

The Display (see Section 4.1) provides printer information:

- Current time and date;
- Soft Key Labels to denote Soft Key functions;
- Label counts during batch jobs;
- When in Menu Mode, the System Menu;
- When in Test Mode, the Test Menu;
- Various messages; and,
- Real-time status notifications (see below).

Display Size		Current State Icons*
Large	Small	
		Initialization, typically brief (but a damaged or invalid printhead can delay the process).
		Display large fonts; see Section 4.1.2.
		Input Mode – DPL; see Section 4.2.4.
		Input Mode – LINE; see Section 4.2.4.
		Input Mode – PL-Z; see Section 4.2.4.
		RFID detected.
		SD memory card detected.
		USB memory (or keyboard) detected.
		Wired network detected.
		Server inaccessible.
		WLAN associated with Access Point.
		WLAN not associated with Access Point.
		WLAN ADHOC Mode.
	**	Receiving data.
	**	Paused.
	**	Faulted, see Section 6.1.2.

*Also see ICON DESCRIPTIONS, Section 4.2.6.

**LED

4.1.2 Keypad Functions

The Keys and Buttons of the Keypad (see Section 4.1) control printer functions:

- The Soft Keys are mode-dependent, changing functions as needed; and,
- The Navigation Buttons allow movement through and changes to menu items and parameters, where the highlighted item is selectable (by pressing ENTER) or enabled (e.g., a default setting).

Depending upon the printer's state, many functions can be accessed by pressing (or pressing and holding for various durations) the keys and buttons:

Keypad Functions			
Function	Printer State	Pressing Sequence	Related Section
Calibration, Empty Value	Idle	Long PAUSE & FEED	5.2
Calibration, RFID Option	Idle	Long FEED & TEST	4.2.3
Calibration, Quick	Idle	Long FEED	3.4
Display Contrast Adjustment	Idle	Hold MENU	4.1
Display large fonts	Idle	DOWN ARROW	4.1.1
Feed / Clear Fault	Idle	FEED	4.1
Pause	Idle	PAUSE	4.1
Print Label, Configuration	Idle	FEED & CANCEL	4.3.5
Print Label, Network	Idle	PAUSE, FEED, & CANCEL	4.2.5
Print Label, Quality	Idle	PAUSE & FEED	4.3.1
Reset, Soft	Idle	Long CANCEL	5.3.1
System Menu	Idle	MENU	4.2
Test Menu	Idle	TEST	4.3
Boot Mode	Power-Up	Hold PAUSE & TEST	5.7
Hex Dump Mode	Power-Up	Hold FEED	6.2
Reset, Level 1	Power-Up	PAUSE & FEED	5.3.2
Reset, Level 2	Power-Up	Hold PAUSE, FEED, & CANCEL	5.3.3

4.2 The System Menu

The System Menu is composed of seven menu branches:

MEDIA SETTINGS
PRINT CONTROL
PRINTER OPTIONS
SYSTEM SETTINGS
COMMUNICATIONS
DIAGNOSTICS
MCL OPTIONS

To enter the System Menu, press the Menu Button.

(This places the printer in Menu Mode, taking it offline, halting the processing of new data.)



Menu, Test, and Navigation Buttons



- Prompts may appear before menu access is granted or before changes are enacted; see Section 5.1.1.
 - MENU MODE controls the access level; see Section 4.2.4.
 - Host software commands may, in some cases, override menu settings; see Section 4.2.5.
 - Depending upon the firmware and options, some menu items may not be present or may indicate NOT INSTALLED.
 - In the descriptions below “✧” denotes a firmware default setting, while “ ” denotes a setting only modifiable via the menu.
-

4.2.1 Media Settings

The Media Settings menu contains label and ribbon settings, and printhead maintenance selections.

Menu Item	Details
MEDIA TYPE	Selects the printing method, where:
DIRECT THERMAL	Sets printing for heat reactive media.
✧THERMAL TRANSFER	Sets printing for media that requires ribbon to produce an image.
SENSOR TYPE	Selects the Top Of Form (TOF) sensing method used to determine the leading edge of the label, where:
✧GAP	Senses the gaps or notches in the media.
CONTINUOUS	Uses the LABEL LENGTH (see below) to determine the TOF.
REFLECTIVE	Senses the reflective (black) marks on the underside of the media.
LABEL LENGTH	Determines the length of the label when the SENSOR TYPE is set to CONTINUOUS, where:
(0 – 99.99 in.) ✧04.00	Is the desired length of the format.
MAXIMUM LABEL LENGTH	Sets the distance that the printer will feed GAP or REFLECTIVE media before declaring a TOF fault, where:
(0 – 99.99 in.) ✧16.00	Is the length of travel to detect a TOF gap or mark. <input checked="" type="checkbox"/> <i>This distance should be 2.5 to 3 times the label length.</i>
PAPER EMPTY DISTANCE	Sets the distance the printer will attempt to feed media before declaring an Out Of Stock fault, where:
(0 – 99.99 in.) ✧00.25	Is the length of travel to detect the presence of media. <input checked="" type="checkbox"/> <i>If using transparent or translucent media, this setting should be longer than the label length.</i>
LABEL WIDTH	Sets the maximum printable width. Objects extending beyond this limit will NOT print, where:
(X.XX – X.XX in.) ✧X.XX	Is the maximum width; see Appendix B for the model dependant default and range.

Media Settings (continued)

Menu Item	Details
RIBBON LOW OPTIONS	Defines the response when THERMAL TRANSFER is selected and the ribbon supply diminishes, where:
RIBBON LOW DIAMETER	Sets the threshold that will trigger a Low Ribbon Warning prompt, where:
(1.00 – 2.00 in.) ✦1.38	Is the outer diameter size of the roll.
PAUSE ON RIBBON LOW	Sets the printer to pause when the Ribbon Low Diameter setting is met, where:
ENABLED	Forces you to press the PAUSE Key to proceed with the print job.
✦DISABLED	Allows printing to continue until ribbon empty is declared.
SENSOR CALIBRATION	Selects the method that is used to calibrate the media sensor (see Section 5.2), where:
PERFORM CALIBRATION	Allows automatic calibration, where:
YES	Establishes the best values based on sampled readings.
NO	Exits the menu item without changing the current settings.
ADVANCED ENTRY	Sets the values via manual entry process, where:
PAPER SENSOR LEVEL ✦170 (0 – 255)	Establishes the threshold value for standard paper.
REFL PAPER LEVEL ✦020 (0 – 255)	Establishes the threshold value for reflective paper.
GAP SENSOR LEVEL ✦016 (0 – 255)	Establishes the threshold value for the gap/notch.
MARK SENSOR LEVEL ✦230 (0 – 255)	Establishes the threshold value for the reflective mark.
EMPTY SENSOR LEVEL ✦009 (0 – 255)	Establishes the threshold value for the empty condition.
TRAN SENSOR GAIN ✦31 (0 – 31)	Establishes the sensitivity of the gap/notch sensor.
REFL SENSOR GAIN ✦13 (0 – 31)	Establishes the sensitivity of the reflective sensor.

Media Settings (continued)

Menu Item	Details
PRINTHEAD CLEANING	Controls printhead cleaning alerts and functions, where:
CLEAN HEAD SCHEDULE 0 – 200 in.(* 1000) ◇000	Specifies the inch (or centimeter) count (multiplied by one thousand) at which to clean the printhead. If this count is exceeded three times, a Head Cleaning Fault will occur. <input checked="" type="checkbox"/> Zero (000) disables this function.
CLEAN HEAD COUNTER	Indicates the number of inches (or centimeters) since a cleaning was last initiated.
RESET COUNTER	Allows the Clean Head Schedule to restart the count, where:
YES	Resets the CLEAN HEAD COUNTER.
NO	Exits the menu item without changing the current setting.
CLEAN HEAD NOW	Allows cleaning to begin, where:
YES	Initiates the cleaning process and resets the Clean Head Counter (see Section 5.5.1).
NO	Exits the menu item without cleaning.

4.2.2 Print Control

The Print Control menu contains print quality, throughput and formatting functions:

Menu Item	Details
HEAT	Controls the burn-time of the printhead (selectable as "Heat" in most labeling programs), where:
(0 – 30) ✦10	Is the number based on duration, corresponding to print darkness.
PRINT SPEED	Controls the rate of label movement during printing, where:
✦XX.X in/sec	Is the speed; see Appendix C for the model dependant default and range. <input checked="" type="checkbox"/> <i>Slower rates may be needed for detailed images, while faster rates may require an increased HEAT setting for sufficient energy transfer.</i>
FEED SPEED	Controls the rate of label movement between printing areas, where:
✦XX.X in/sec	Is the speed; see Appendix C for the model dependant default and range.
REVERSE SPEED	Controls the rate of label movement during backup positioning, where:
✦X.X in/sec	Is the speed; see Appendix C for the default and range.
SLEW SPEED	Controls the rate of label movement between printing areas when using the optional Applicator Interface Card's GPIO function, where:
✦XX.X in/sec	Is the speed; see Appendix C for the default and range.
ROW OFFSET	Shifts the vertical SOP position on the label, where:
(0 – 99.99 in.) ✦00.00	Is the offset distance; see Section 7 for label details.
COLUMN OFFSET	Shifts the horizontal, left-justified SOP position to the right without shifting the Label Width termination point to the right, where:
(0 – 99.99 in.) ✦00.00	Is the offset distance; see Section 7 for label details.

Print Control (continued)

Menu Item	Details
PRESENT DISTANCE	Sets the label stop position, where:
(0 – 4.00 in.) ✧AUTO 0.00	Is the label output distance. The default setting (Auto) configures this distance according to the positioning requirements of the attached device (e.g., tear bar, cutter, etc). <input checked="" type="checkbox"/> <i>When set to 0.01 in., NONE is assumed; a zero (0) positioning value will be used.</i>
TOF PRECEDENCE	Allows an override of label format data when the form length is exceeded, where:
✧DISABLED	Prints labels formats without TOF truncating.
ENABLED	Ends the label at the next TOF, truncating any print data that extends past this mark.
CUSTOM ADJUSTMENTS	Allows slight, printer-specific adjustments, where:
DARKNESS ✧32 (1 – 64)	Controls the printhead strobe time (see HEAT) to fine-tune the solid areas of an image.
CONTRAST ✧32 (1 – 64)	Fine-tunes the gray areas of an image.
ROW ADJUST ✧0000 (~XXX – XXXX DOTS)	Shifts the vertical SOP position to fine-tune ROW OFFSET; see Appendix B. <input checked="" type="checkbox"/> <i>If shifting in the negative direction, modify PRESENT ADJUST (below) by the same amount.</i>
COLUMN ADJUST ✧000 (~XXX – XXX DOTS)	Shifts both the horizontal SOP position and the LABEL WIDTH termination point to the right to fine-tune COLUMN OFFSET; see Appendix B.
PRESENT ADJUST ✧000 (~XXX – XXXX DOTS)	Adjusts the label stopping position to fine-tune PRESENT DISTANCE; see Appendix B.

4.2.3 Printer Options

The Printer Options menu contains module, file handling, and option functions:

Menu Item	Details
MODULES	Controls memory handling functions, where:
DIRECTORY	Allows viewing and printing of available space and file types (including plug-ins) present on a module. Only detected modules will be listed, and selecting ALL will display all results; see Appendix A.
PRINT FILE	Prints selections from listings of available files, including .dlb, .dpl, .prn and .txt formats; see File Handling Definitions, Appendix A.
PROCESS FILE	Processes a selected file for use by the printer; see File Handling Definitions, Appendix A.
FORMAT MODULE	Formats a selected module; see Appendix A.
	 <i>FORMAT MODULE will erase all data in the selected module.</i>
DELETE FILE	Deletes a file from a list of available files; see File Handling Messages, Appendix A.
	<input checked="" type="checkbox"/> <i>Protected modules will not be displayed, and space will not be recovered until packed.</i>
COPY FILE	Selects from a list of available files and prompts for the destination module before copying; see File Handling Messages, Appendix A.
UNPROTECT MODULE	Selects from a list of available modules then prompts regarding the unprotect attempt; see File Handling Messages, Appendix A.

Printer Options (continued)

Menu Item	Details
PRESENT SENSOR	Controls the Present Sensor or the Peel and Present option, where:
MODE	Sets the detection method and response of the printer, where:
DISABLED	Disables the option.
✧AUTO	Detects, enables, and sets the label stop location for the sensor option; if not detected, the option will be ignored.
ENABLED	Enables and sets the label stop location for the option; if not detected, a fault will be generated.
RETRACT DELAY	Programs a time delay for the retraction of the next label in the print process, where:
(1 - 255 x10mS) ✧070	Is the duration, times 10 milliseconds.
CUTTER	Controls the Cutter option, where:
MODE	Sets the detection method and response of the printer, where:
DISABLED	Disables the option.
✧AUTO	Detects, enables, and sets the label stop location for the cutter; if not detected, the option will be ignored.
ENABLED	Enables and sets the label stop location for the cutter; if not detected, a fault will be generated.
CUT BEHIND	Allows a number of small labels to queue before a cut is performed, increasing throughput, where: <i>☑ This mode can be used without a cutter to allow the presentation of an extra label, with retraction occurring upon the next job or feed operation.</i>
(0 - 2) ✧0	Is the queue number. <i>☑ After a fault or unknown label position, a leading edge cut will be performed to ensure against extra length on the first label; otherwise, cutting will occur only as specified.</i>

Printer Options (continued)

Menu Item	Details
SCANNER	Controls the Linear Scanner option (see the <i>Class Series 2 Programmer's Manual</i> for bar code applicability), where:
MODE	Sets the detection method and response of the printer, where:
DISABLED	Disables the option.
✧AUTO	Detects and enables the scanner; if not detected, the option will be ignored.
ENABLED	Enables the scanner; if not detected, a fault will be generated.
BARCODES	Specifies the bar code type(s) for scanning, where: <hr/> <input checked="" type="checkbox"/> <i>Enabling only the types to be checked helps maximize throughput.</i> <hr/>
✧CODE 39	Is / are the bar code type(s) to be checked; see the <i>Class Series 2 Programmer's Manual</i> for symbology details.
IATA	
✧CODABAR	
✧INTERLEAVED 2 OF 5	
✧INDUSTRIAL 2 OF 5	
✧CODE 93	
✧CODE 128	
✧MSI/PLESSEY	
✧EAN(13/8)	
✧EAN(13/8)+2	
✧EAN(13/8)+5	
✧UPC(A/E)	
✧UPC(A/E)+2	
✧UPC(A/E)+5	
BARCODE COUNT	Specifies the number of bar codes per label then generates a fault if the number present is incorrect, where:
(0 - 99)	Sets the number of bar codes to count, where 00 (Auto Mode) allows a variable number. <hr/> <input checked="" type="checkbox"/> <i>If bar codes are bitmaps, enter the minimum number to be read on each label (check your software application if questioning the bar code generation method).</i> <hr/>
✧00	

Printer Options (continued)

Menu Item	Details
MIN READABLE HEIGHT	Ensures bar code integrity by setting a minimum distance for identical decodes, where:
✧DISABLED	Uses REDUNDANCY LEVEL to ensure bar code integrity.
1/16 – 1/2 in. (1.5 – 12.5 mm)	Sets the read height (e.g., a setting of 1/4 requires .25 inches of the bar code height be 100% readable). <input checked="" type="checkbox"/> <i>This distance should not exceed 50% of the measured bar code height.</i>
REDUNDANCY LEVEL	Ensures bar code integrity by specifying a consecutive number of identical decodes, where:
(1X – 6X) ✧3X	Sets the read count (e.g., a 3X setting requires three identical decodes to pass). <input checked="" type="checkbox"/> <i>High redundancy rates and fast print speeds can cause erroneous failures when scanning small or multiple bar codes.</i>
AUTO	Uses MIN READABLE HEIGHT to ensure bar code integrity.
IGNORE NO DATA	Allows an override of the verification function, where:
✧DISABLED	Checks for correct bar code data in the bar code(s).
ENABLED	Ignores the data present in the bar code(s).
SET DEFAULTS	Allows the scanner default values to be restored, where:
YES	Restores the default settings.
NO	Exits the menu item without changing the current settings.

Printer Options (continued)

Menu Item	Details
RFID	Controls the RFID option, where: <input checked="" type="checkbox"/> If not detected, this selection will result in a <i>DISABLED</i> message.
RFID MODULE	Sets the mode of RFID operation, where:
DISABLED	Disables the option.
HF	Selects the High Frequency (13.56 MHz) option.
UHF MULTI-PROTOCOL	Selects the Ultra High Frequency (868-956 MHz) option.
RFID POSITION	Sets the RFID encoding position, where:
(1.10 - 4.00 in.) ◇1.10	Is the inlay location (as referenced from the leading edge of the tag moving forward through the printer), where 0.00 uses the print position to encode tag and values greater use the present position (subject to change).
HF SETTINGS	Sets the HF encoding parameters, where:
TAG TYPE	Selects the HF tag type, where:
◇ISO 15693	Is the type to be encoded.
TI	
PHILIPS	
ST LRI512	
ST LRI64	
AFI VALUE	Sets the Application Family Identifier value, where:
(00 - FF) ◇00	Is the hex value.
AFI LOCK	Locks the Application Family Identifier value, where:
ENABLED	Is write-protected.
◇DISABLED	Is not protected.

Printer Options (continued)

Menu Item	Details
DSFID VALUE	Sets the Data Storage Format Identifier value, where:
(00 – FF) ✧00	Is the hex value.
DSFID LOCK	Locks the Data Storage Format Identifier value, where:
ENABLED	Is write-protected.
✧DISABLED	Is not protected.
EAS VALUE	Selects the Electronic Article Surveillance value, where:
(00 – FF) ✧00	Is the hex value.
AUDIO INDICATOR	Controls the buzzer, where:
ENABLED	Allows sound.
✧DISABLED	Inhibits sound.
ERASE ON FAULT	Controls tag erasure if errors are detected, where:
ENABLED	Erases data.
✧DISABLED	Retains faulty data.
UHF SETTINGS	Sets the UHF encoding parameters, where:
TAG TYPE	Selects the tag type, where:
EPC 0	Is the type to be encoded.
EPC 0+ MATRICS	
EPC 0+ IMPINJ	
EPC 1	
UCODE EPC 1.19	
EM 4022/4222	
✧GEN 2	

Printer Options (continued)

Menu Item	Details
TAG DATA SIZE	Sets the tag data size, where:
✧96-BIT	Selects 96 bits (24 hexadecimal characters or 12 ACSII characters).
64-BIT	Selects 64 bits (16 hexadecimal characters or 8 ACSII characters).
POWER ADJUST	Adjusts the applied power, where:
(-04 → 04) ✧000	Is the power level, in 1.0 dBm increments.
KILL CODE	Sets the code to permanently deactivate the tag, where:
✧00 00 00 00	Is the code, in the form B3, B2, B1, B0.
ACCESS CODE	Sets the code to protect tag memory contents, where:
✧00 00 00 00	Is the code, in the form B3, B2, B1, B0.
GEN 2 LOCK ACTION	Sets the lock for Gen 2 tags, where:
✧NONE	Does not lock the tag.
PERMALOCK	Locks data permanently.
PWD-READ/WRITE	Locks data with password-protection for writing data.
BOTH	Allows both Permalock and PWD-Lock to be used.
PAD/TRUNC. EPC DATA	Allows padding or truncating of data with nulls (represented as "00") in order to fit the selected EPC Tag Data Size, where:
✧DISABLED	Does not pad or truncate data.
LEADING	Adds nulls to the front (left) of the data if less than the size, or cuts the data if greater.
TRAILING	Adds nulls to the end (right) of the data if less than the size, or cuts the data if greater.

Printer Options (continued)

Menu Item	Details
LOCK AFTER WRITE	Allows the tag to be locked after programming, where:
ENABLED	Locks the tag.
✧DISABLED	Does not lock the tag.
RETRY ATTEMPTS	Sets the number of retry attempts, where:
(0 - 9) ✧3	Is the retry count before a fault is declared.
PERFORM CALIBRATION	Allows the printer to establish the tag to transducer distance and nominal power setting, where:
YES	Initiates the process; CALIBRATING RFID will be displayed as media is scanned for the tag location and power, followed by TOF positioning and the operational results where, if successful, the database parameters will be updated.
NO	Exits the menu item without calibration.
SET DEFAULTS	Allows the RFID default values to be restored, where:
YES	Restores the default settings.
NO	Exits the menu item without changing the current settings.

Printer Options (continued)

Menu Item	Details
GPIO PORT	Controls the optional Applicator Interface Card's GPIO function, where:
GPIO DEVICE	Sets the option to work with a specific device type, where:
✧DISABLED	Disables the option.
APPLICATOR	Enables parameters for related label applicator functions: <ul style="list-style-type: none"> • Completion upon last SOP, de-asserts Data Ready (DRDY); • FEED allowed at any time; and, • DRDY upon PAUSE.
APPLICATOR 2	Enables parameters for alternate label applicator functions: <ul style="list-style-type: none"> • Completion upon 1 msec. overlap of Data Ready (DRDY) and End of Print (EOP); • DRDY signal end inhibits FEED; and, • De-asserts DRDY upon PAUSE or FAULT.
BARCODE VERIFIER	Enables the parameters for bar code verifier functions.
START OF PRINT	Selects the type of input signal required to initiate printing, where:
LOW PULSE	Triggers printing with a low pulse.
HIGH PULSE	Triggers printing with a high pulse.
ACTIVE LOW	Triggers printing with a low signal.
✧ACTIVE HIGH	Triggers printing with a high signal.
EDGE	Triggers printing with a signal edge transition.

Printer Options (continued)

Menu Item	Details
END OF PRINT	Sets the type of output signal generated to indicate EOP, where:
✧LOW PULSE	Outputs a low pulse upon completion.
HIGH PULSE	Outputs a high pulse upon completion.
ACTIVE LOW	Outputs a logic low upon completion.
ACTIVE HIGH	Outputs a logic high upon completion.
RIBBON LOW	Sets the low ribbon signal (as determined by RIBBON LOW OPTIONS; see Section 4.2.1), where:
✧ACTIVE LOW	Outputs a logic low when the roll size reaches the setting.
ACTIVE HIGH	Outputs a logic high when the roll size reaches the setting.
SLEW ENABLE	Selects the type of input signal required to initiate label slew, where:
✧STANDARD	Triggers slew with a low signal.
LOW PULSE	Triggers slew with a low pulse.
HIGH PULSE	Triggers slew with a high pulse.
ACTIVE LOW	Triggers slew with a low signal.
ACTIVE HIGH	Triggers slew with a high signal.
BACKUP LABEL	Determines reverse label motion when the GPIO option is installed and enabled, where:
✧DISABLED	Disables backup.
ACTIVE LOW	Triggers backup with a low signal.
ACTIVE HIGH	Triggers backup with a high signal.

Printer Options (continued)

Menu Item	Details
ERR ON PAUSE (APP2)	Sets the output when a service required fault occurs (Applicator Interface Card Type 2 equipped only), where:
✧ENABLED	Enables the output signal.
DISABLED	Disables the output signal.
REWINDER	Controls the Powered Internal Rewinder option, where:
MODE	Sets the detection method and response of the printer, where:
DISABLED	Disables the option.
✧AUTO	Enables the rewinder only when a Peel and Present option is installed; however, no error will be generated when the Peel and Present option is not attached. (Upon power-up, the rewinder will turn slowly to tension the material.)
ENABLED	Enables the rewinder and generates an error if it cannot be detected. Upon power-up, the rewinder will turn slowly (for about 30 seconds) to tension the material and then whenever labels move.
REWINDER ADJUSTMENT	Adjusts the amount of rewinding tension to minimize TOF registration drift (sometimes evident when using narrow media), where:
(-30 – 15 %) ✧00	Decreases or increases the nominal torque by the percentage selected.

4.2.4 System Settings

The System Settings menu contains operating, control, and formatting functions:

Menu Item	Details
MENU MODE	Sets the menu access level, where:
✧USER MENU	Accesses limited basic menu items.
ADVANCED MENU	Accesses all menu items.
CONFIGURATION FILE	Controls the creation, storage, and recall of printer configuration files (see Appendix E), where:
RESTORE AS CURRENT	Lists the files available and then, after selection, reconfigures the printer according to that file.
SAVE SETTING AS	Saves the effective printer configuration to a named file of up to nineteen characters.
DELETE FILE	Lists the files available and then after selection, removes that file from memory. <input checked="" type="checkbox"/> <i>An active file cannot be deleted.</i>
FACTORY SETTING FILE	Lists the files available, and then after selection, that file will be restored whenever a Level One reset is performed; see Section 5.3.2.
INTERNAL MODULE	Allocates a number of 1KB memory blocks to the internal memory module; where:
(XXX – XXXX KB) ✧1024	Is the memory allocation; see Appendix A.
DEFAULT MODULE	Designates the storage module when no memory location is specified; where:
G ✧D	Is the module; see Appendix A for availability.
SCALEABLE FONT CACHE	Configures the number of 1KB memory blocks for the scalable font engine; where:
(XXX – XXXX KB) ✧0511	Is the memory allocation; see Appendix A for availability.
SINGLE BYTE SYMBOLS	Sets the code page used for single byte fonts, where:
✧PC-850 MULTILINGUAL	Is the selected code page. (See the <i>Class Series 2 Programmer's Manual</i> for a complete listing.)



System Settings (continued)

Menu Item	Details
DOUBLE BYTE SYMBOLS	Selects the code page (see the <i>Class Series 2 Programmer's Manual</i>) used for the ILPC option (unless otherwise specified), where:
JIS	Selects Japanese Industry Standard.
SHIFT JIS	Selects Shift Japanese Industry Standard.
EUC	Selects Extended UNIX Code.
◇UNICODE	Selects Unicode (including Korean).
GB	Selects Government Bureau Industry Standard, Chinese (PRC).
BIG 5	Selects Taiwan encoded.
TIME AND DATE	Sets the time and date, where:
SET HOUR 06:30 AM 01 FEB 2005	Enters the time and date information.
MEDIA COUNTERS	Displays and controls various internal counters, where:
ABSOLUTE COUNTER	Are the total inches printed and the set date. (Non-resettable)
PRINthead COUNTER	Is the total number of inches printed. (Non-resettable)
RESETTABLE COUNTER	Are the inches printed and the last reset date.
RESET COUNTER	Returns the RESETTABLE COUNTER to zero.
PRINT CONFIGURATION	Prints current database information; see Section 4.3.5.
CONFIGURATION LEVEL	Displays the hardware and software levels of the printer, where: <hr/> <input checked="" type="checkbox"/> This data is also provided on the Configuration Label; see Section 4.3.5. <hr/>

System Settings (continued)

Menu Item	Details
PRINTER KEY	Identifies the unique key number of the printer, in the form: $vvvv-cwxx-yyyyyy-zzz$ Where: vvvv – Represents the printer model number. cwxx – Represents the hardware and software levels, where: c – Is the printer class. w – Is the main board hardware level. xx – Is the software feature level: 10 = Standard DPL 20 = Internal CG Times Font <hr/> <input checked="" type="checkbox"/> <i>Increases beyond the feature level require authorization.</i> <hr/> yyyyyy – Is a manufacturing date code. zzz – Is a unique time stamp.
APPLICATION VERSION	Displays the firmware program number, version, and date.
BOOT LOADER	Displays the Boot Loader version and date.
UPGRADE PRINTER CODE 0 0 0 0 0 0	Upgrades the printer to the corresponding features level with the correct code entry (where authorization may be required).
UNLOCK FEATURE 0 0 0 0 0 0	Unlocks a feature with the correct code entry.
SET FACTORY DEFAULTS	Returns the factory-programmed values or the Factory Setting File values, where:
YES	Restores the default settings, or if selected the Factory Setting File. <hr/> <input checked="" type="checkbox"/> <i>A reset will occur and, if no Factory Setting File is used, all settings returned except CUSTOM ADJUSTMENTS and calibrations.</i> <hr/>
NO	Exits the menu item without changing the current settings.

System Settings (continued)

Menu Item	Details
FORMAT ATTRIBUTES	Defines the way overlapping text, bar codes, and graphics are printed, where:
TRANSPARENT	Prints intersecting areas, for example: 
✧XOR	Obliterates intersecting areas, for example: 
OPAQUE	Overwrites intersecting areas with those last formatted, for example: 
LABEL ROTATION	Allows the label format to be flipped 180 degrees, where:
ENABLED	Prints formats after 180° rotation.
✧DISABLED	Prints formats without rotation.
IMAGING MODE	Determines the process used to format labels, where:
✧MULTIPLE LABEL	Formats multiple images, as memory permits, for the fastest throughput. <hr/> <input checked="" type="checkbox"/> <i>Time stamps will indicate the moment of imaging rather than printing.</i>
SINGLE LABEL	Formats an image only after a previous format has been printed (for the most accurate time stamps).
PAUSE MODE	Allows interactive print control, where:
ENABLED	Prints only as the PAUSE Key is pressed.
✧DISABLED	Prints normally, without user intervention.
PEEL MODE	Allows the SOP signal to initiate (via the optional GPIO port) the feeding of labels, where:
ENABLED	Feeds labels only after SOP is received.
✧DISABLED	Feeds labels regardless of SOP.

System Settings (continued)

Menu Item	Details
SECURITY	Allows menu password protection, where:
SELECT SECURITY	Enables or disables the security feature, where: <input checked="" type="checkbox"/> <i>The default password must be changed to activate.</i>
◇DISABLED	Accesses all areas.
SECURE MENU	Sets a password requirement for menu access.
MENU AND TEST	Sets a password requirement for menu and test access.
ADVANCED MENU	Sets a password requirement for Advanced Menu access. <input checked="" type="checkbox"/> <i>After enabling this selection, return MENU MODE to the USER MENU setting.</i>
MODIFY PASSWORD	Modifies the security password, where:
YES	Allows entry of a four-digit password (after confirmation). <input checked="" type="checkbox"/> <i>The default password is 0000.</i>
NO	Exits the menu item without changing the current settings.
UNITS OF MEASURE	Sets the measurement standard of the printer, where:
◇IMPERIAL	Uses inches.
METRIC	Uses millimeters and centimeters.

System Settings (continued)

Menu Item	Details
INPUT MODE	<p>Defines the type of processing that occurs when data is received, where:</p> <hr/> <p>✔ See the Class Series 2 Programmer's Manual for detailed information.</p>
✧DPL	Processes data for standard DPL printing.
LINE	Processes data for Line Mode (template) printing.
PL-Z	Processes data for PL-Z printing.
AUTO	<p>Identifies then activates the appropriate emulation parser for the data.</p> <hr/> <p>✔ Correct identification can be dependent upon the HOST SETTINGS / HOST TIMEOUT (see Section 4.2.5). Also, extraneous characters may, in some cases, render the data unrecognizable, thus requiring manual selection of the mode.</p>
USER LABEL MODE	Sets the printer to power-up as default, where:
ENABLED	<p>Functions in standalone mode for quick access to user defined formats; see Section 4.3.7.</p> <hr/> <p>✔ This mode will remain active until disabled.</p>
✧DISABLED	Functions in normal mode, awaiting commands from a host.
DPL EMULATION	<p>Allows legacy printer emulation, where:</p> <hr/> <p>✔ Ignores label commands A, M, n & T; see the Class Series 2 Programmer's Manual for information.</p>
✧STANDARD	Uses no legacy emulation, all commands recognized.
ALLEGRO	Emulates the Allegro®.
PRODIGY PLUS	Emulates the Prodigy Plus®.
PRODIGY	Emulates the Prodigy™.

System Settings (continued)

Menu Item	Details
COLUMN EMULATION	Allows the column dot count to be adjusted, where:
(XXX – XXX DOTS) ✧XXX	Is the printed number of dots per inch (or mm) thereby reducing the width of the produced format; see Appendix B. <input checked="" type="checkbox"/> No adjustment occurs at the default setting.
ROW EMULATION	Allows the row dot count to be adjusted, where:
(XXX – XXX DOTS) ✧XXX	Is the printed number of dots per inch (or mm) thereby reducing or enlarging the length of the produced format; see Appendix B. <input checked="" type="checkbox"/> No adjustment occurs at the default setting.
SOP EMULATION	Allows SOP functions with backward compatibility when printing legacy model label formats, where: <input checked="" type="checkbox"/> Two labels will automatically feed to establish the selected position.
✧DISABLED	Uses the standard print position.
110 (PRODPLUS)	Emulates the Prodigy Plus [®] print position.
220 (ALLEGRO)	Emulates the Allegro [®] print position.
250 (PRODIGY)	Emulates the Prodigy [™] print position.
BACK AFTER PRINT	Determines media movement when a cutter, present sensor, peel and present, or GPIO is enabled, where:
MODE	Repositions media, where:
✧DISABLED	Movement occurs only when the next label is ready to print, minimizing edge curling.
ENABLED	Movement occurs according to BACKUP DELAY timing after a cut, cleared sensor, or SOP to allow fastest throughput.
BACKUP DELAY (1/50s)	Determines repositioning timing, where:
(0 – 255) ✧000	Is the specified lapse (in fiftieths of a second) between new format processing and label retraction.

System Settings (continued)

Menu Item	Details
FONT EMULATION	Allows font substitution, where:
✧STANDARD FONTS	Prints using standard (internal) fonts.
CGTIMES	Prints using CG Times font.
USER ID S50	Prints using a downloaded font.
LABEL STORE	Determines the data content when retrieving stored label formats, where:
✧STATE & FIELDS	Recalls the printer state (i.e., heat, speeds, etc.) and the formatting commands for a stored label.
FIELDS ONLY	Recalls the formatting commands for a stored label.
MENU LANGUAGE	Selects the language for the System Menu and Configuration Label, where: <i>☑ Only resident languages will be selectable; see Appendix D.</i>
✧ENGLISH	Is standard.
DISPLAY SETTINGS	Determines the appearance of the items in the Main Display Area of the LCD, where:
GRAPHIC DISPLAY MODE	Determines the magnification of the items, where:
✧STANDARD	Is the normal setting.
ENHANCED	Is the enlarged setting.
DISPLAY UNITS	Determines the displayed type of distance information, where:
✧STANDARD	Displays the information according to the UNITS OF MEASURE setting (see above).
IMPERIAL	Displays the information in inches.
METRIC	Displays the information in millimeters and centimeters.

System Settings (continued)

Menu Item	Details
FAULT HANDLING	Determines the label disposition and user action if a fault occurs, where:
LEVEL	Sets the printer response upon declaration of a fault, where:
NO REPRINT	Stops printing and declares a fault. Then, following correction of the problem, the FEED Key must be pressed to clear the fault.
◇STANDARD	Stops printing and declares a fault. Then, following correction of the problem, the FEED Key must be pressed to clear the fault and reprint the label in process.
VOID AND RETRY	<p>Actions depend upon the RETRY COUNT:</p> <ul style="list-style-type: none"> • If the count has not been exceeded, VOID is printed on the failed label and reprinting automatically occurs; • If the count has been exceeded, printing stops and a fault message is displayed. Then, following correction of the problem, the FEED Key must be pressed to clear the fault and reprint the label in process; or, • If the CANCEL Key is pressed, reprinting is optional: press NO to reprint; or, press YES to cancel the reprint (and press YES again to cancel the batch.) <hr/> <p><input checked="" type="checkbox"/> <i>Linear Scanner or RFID required.</i></p>
DELAYED SCAN FAULT	<p>Increases throughput when bar codes reside near the trailing edge of the label (in the direction of FEED).</p> <hr/> <p><input checked="" type="checkbox"/> <i>Linear Scanner or RFID required.</i></p> <ul style="list-style-type: none"> • <i>If unreadable, the fault will occur after the next label prints;</i> • <i>The label immediately following a faulted label is not scanned for errors; and,</i> • <i>VOID AND RETRY and REPRINT are automatically disabled; the job can only be cancelled.</i>
VOID RETRY & CONT.	<p>VOID is printed on a faulted label, with reprint attempts occurring automatically, until the RETRY COUNT has been exceeded and then that label will be skipped (discarded) and printing will continue to the next label in queue.</p> <hr/> <p><input checked="" type="checkbox"/> <i>Linear Scanner or RFID required.</i></p>

System Settings (continued)

Menu Item	Details
VOID DISTANCE	Sets the distance to print VOID on a faulted label, where:
(0.10 to 2.00 in.) ◇0.50	Is the distance, measured from the trailing edge, which establishes the text size. <input checked="" type="checkbox"/> VOID will not be printed if insufficient text space exists or if the fault occurred after printing completed. Also, the text can be customized; see the Class Series 2 Programmer's Manual.
RETRY COUNT	Sets the number of printing attempts before declaring a fault, where:
(0 – 3) ◇1	Is the count. <input checked="" type="checkbox"/> Greater than 1 (one) counts are valid only when Linear Scanner or RFID equipped.
BACKFEED ON CLEAR	Determines positioning after a fault is cleared, where:
ENABLED	Automatically positions the label.
◇DISABLED	No label positioning occurs, as the location is assumed correct. <input checked="" type="checkbox"/> If reloading, you must place the media at the SOP position.
SCL FONT BOLD FACTOR	Sets a scalable font boldfacing amount, where:
(1 – 36) ◇08	Is the setting, based on an incrementing scale where eight (08) is nominal.

4.2.5 Communications

The Communications menu contains interface port and host control functions:

Menu Item	Details
SERIAL PORT A	Controls the RS-232 communications settings for Serial Port A, where:
BAUD RATE	Sets the serial communication rate, where:
1200 BPS	Is the serial speed in Bits Per Second.
2400 BPS	
4800 BPS	
◇9600 BPS	
19200 BPS	
28800 BPS	
38400 BPS	
57600 BPS	
115000 BPS	
PROTOCOL	Sets the data flow control method (handshaking), where:
◇BOTH	Uses XON/XOFF and CTS/DTR.
SOFTWARE	Uses XON/XOFF.
HARDWARE	Uses CTS/DTR.
NONE	Disables flow control.
PARITY	Sets word parity, where:
◇NONE	Uses parity.
ODD	Uses Odd parity.
EVEN	Uses Even parity.
DATA BITS	Sets Word length, where:
(7 - 8) ◇8	Is the number of bits in the word.
STOP BITS	Sets the stop bit count, where:
(1 - 2) ◇1	Is number of stop bits.



Communications (continued)

Menu Item	Details
SERIAL PORT C	<p>Controls the settings for the optional Applicator Interface COM C (J4) port, where the settings are the same as those given for the SERIAL PORT A.</p> <hr/> <p><input checked="" type="checkbox"/> <i>The maximum baud is 38.4K BPS.</i></p>
SERIAL PORT D	<p>Controls the settings for the optional Applicator Interface COM D (J3) port, where the settings are the same as those given for the SERIAL PORT A.</p> <hr/> <p><input checked="" type="checkbox"/> <i>The maximum baud is 38.4K BPS.</i></p>
PARALLEL PORT A	<p>Controls the communications settings for Parallel Port A, where:</p>
PORT DIRECTION	<p>Allows printer data to be returned to the host, where:</p>
UNI-DIRECTIONAL	<p>Returns no data (one-way communication).</p>
◇BI-DIRECTIONAL	<p>Returns data (compliant back-channel operation); see Section 2.2.2 for cable requirements.</p>
NIC ADAPTER	<p>Controls the communications settings for the network interface, where:</p>
QUICK SETUP	<p>Selects settings to configure basic Wired or WiFi operations, where:</p>
WIRED DHCP	<p>Selects Wired operation, where:</p>
NO	<p>Exits the menu item without changing the current settings.</p>
YES	<p>Returns the NIC Adapter to defaults then sets Wired Discovery to "Enable" and Wireless to "Disable."</p>

Communications (continued)

Menu Item	Details
WLAN UNSECURED	Selects WiFi operation, where:
NO	Exits the menu item without changing the current settings.
YES	Returns the NIC Adapter default values then sets Discovery to "Enable," SSID to "Any," and WLAN network type to "Infrastructure."
WLAN ADHOC	Selects the DMXrfNetII default parameters, where:
NO	Exits the menu item without changing the current settings.
YES	Restores WiFi defaults and initiates infrastructure mode with an SSID of "Any." All existing access point associations will be deleted then established with the closest available. (Useful when moving the printer to a geographically distant location.)
SET FACTORY DEFAULTS	Returns the factory-programmed values, where:
NO	Exits the menu item without changing the current settings.
YES	Restores the default settings.
WLAN	Controls the communications settings for the DMXfNetII Card, where:
MODE	Selects between Wired or WiFi operation, where:
ENABLED	Enables the WiFi interface.
◇DISABLED	Enables the wired interface.
BSS ADDRESS	Specifies the static IP address of the WiFi bridge module. <i>✔ If DHCP is Enabled, this parameter will be ignored.</i>
◇ 000.000.000.000	Is the address in standard octet format.
SIGNAL READINGS	Displays the WLAN signal and noise ratios.
IP ADDRESS	Specifies the static IP Address; where:
◇192.168.010.026	Is the address in standard octet format.

Communications (continued)

Menu Item	Details
SUBNET MASK	Specifies the static Subnet Mask Address, where:
✧255.255.255.000	Is the address in standard octet format.
GATEWAY	Specifies the network Gateway Address, where:
✧192.168.010.026	Is the address in standard octet format.
SNMPTRAP DESTINATION	Specifies the SNMP Trap Address, where:
✧000.000.000.000	Is the address in standard octet format where SNMP traps will be sent when SNMP service is installed on your receiver. <hr/>  <i>When zeroed, no traps are sent.</i>
IP DISCOVERY	Controls IP Address discovery, where:
✧ENABLED	Broadcasts over the network at startup to receive addresses from the responsible server. Manual modifications to IP Address, Subnet Mask, or Gateway are not allowed; and, if no server is found, the specified static value will be used. <hr/>  <i>A server assigned IP address takes precedence over any static address stored in the interface.</i>
DISABLED	Uses the stored static IP, Subnet Mask, and / or Gateway Address.
SNMP	Allows management protocols, where:
✧ENABLED	Sends messages to SNMP-compliant devices.
DISABLED	Sends no messages.
ADVANCED	Sets advanced networking functions and parameters, where:
TELNET	Sets Telnet protocol to transfer data, where:
✧ENABLED	Allows Telnet.
DISABLED	Disables Telnet.

Communications (continued)

Menu Item	Details
FTP	Sets File Transfer Protocol to transfer data, where:
◇ENABLED	Allows FTP.
DISABLED	Disables FTP.
MTU	Sets the Maximum Transmission Unit packet size, where:
(512 - 65515) ◇01500	Is the packet size, in bytes.
GRATUITOUS ARP	Sets the Address Resolution Protocol notification rate, where:
(0 - 2048) ◇0000	Is the time, in minutes.
PORT NUMBER	Sets the network communications port, where:
(1 - 65535) ◇09100	Is the Port Number.
TCP KEEPALIVE	Allows monitoring of an open connection to detect any disconnects not properly closed, including reset access points and unplugged printers, where:
ENABLED	Keeps monitoring active.
◇DISABLED	Closes such a disconnection after 2.5 minutes.
DUPLEX CAPABILITY	Sets the communication capability for the Wired network, where:
◇AUTO-NEGOTIATE	Automatically selects the best type.
100BASET HALF	Selects 100 Mbit/s half duplex (in both directions, one way at a time) operation.
100BASET FULL	Selects 100 Mbit/s full duplex (in both directions, simultaneously) operation.
10BASET HALF	Selects 10 Mbit/s half duplex (in both directions, one way at a time) operation.
10BASET FULL	Selects 10 Mbit/s full duplex (in both directions, simultaneously) operation.
ADVERTISE CAPABILITY	Transmits the printer's communication capability for the Wired network, where:
◇AUTOMATIC	Advertises the DUPLEX CAPABILITY set value.
ALL CAPABILITIES	Advertises all possible values for DUPLEX CAPABILITY.

Communications (continued)

Menu Item	Details
NETWORK REPORT	Allows viewing or printing of the network status report, where:
VIEW	Displays the report.
PRINT	Prints the report: <div style="border: 1px solid black; padding: 5px; width: fit-content;"> <pre> NETWORK REPORT WED 03:15PM 23JUL2008 CURRENT PRINTER INFO MACO: 00:0D:70:08:8B:B9 IP ADDRESS: 192.168.10.26 SUBNET MASK: 255.255.255.0 GATEWAY: 192.168.10.26 DHCP: ENABLED SNMP: ENABLED PORT NUMBER: 9100 NETBIOS NAME: DMX_038BB9 WLAN MODULE MODULE FW VERSION: 4.3.0.24 RADIO FW VERSION: 1.1.1.1118.4.0.145 PORT STATUS: CONNECTED: ESS SSID: 000B2802D65E MACR: 00:0B:28:02:D6:5E BSSADDRESS: PROVIDED BY DHCP </pre> </div>
SET FACTORY DEFAULTS	Returns the factory-programmed values, where:
YES	Restores the default settings. <input checked="" type="checkbox"/> <i>A reset will occur and all settings will be restored except CUSTOM ADJUSTMENTS and calibrations.</i>
NO	Exits without changing the current settings.
HOST SETTINGS	Sets host communication parameters, where:
HOST TIMEOUT	Sets the period that an interface port can be idle before timeout occurs, where:
(1 - 60 SEC) ◇10	Is the time (in seconds) when downloads timeout, and that must elapse before alternate port or alternate parser processing can occur.
CONTROL CODES	Allows changes to the software command interpretation controls, where:
◇STANDARD CODES	Sets these interpretation codes: Hex 01 = SOH command; Hex 02 = STX command; count-by = ^; Hex 1B = ESC; Hex 0x0D = Carriage Return
ALTERNATE CODES	Sets these interpretation codes: Hex 5E = SOH command; Hex 7E = STX command; count-by = @; Hex 1B = ESC; Hex 0x0D = Carriage Return
ALTERNATE CODES 2	Sets these interpretation codes: Hex 5E = SOH command; Hex 7E = STX command; count-by = @; Hex 1B = ESC; Hex 0x7C = Carriage Return
CUSTOM CODES	Sets interpretation codes, where:
STANDARD CODES SOH STX CR CNTBY 01 02 0D 5E	Are the codes according to your definition. <input checked="" type="checkbox"/> <i>Standard codes serve as default placeholders.</i>

Communications (continued)

Menu Item	Details
FEEDBACK CHARACTERS	Allows the return of printer codes, where:
ENABLED	Sends the host a Hex 1E (RS) after each label and a Hex 1F (US) after each batch successfully prints.
✧DISABLED	Sends no feedback characters.
ESC SEQUENCES	Sets handling for data containing invalid ESC sequences, where:
✧ENABLED	Processes commands normally.
DISABLED	<p> Ignores ESC control codes during processing (as some systems send “banners” to the printer).</p> <hr/> <p> <i>Bitmapped font downloads will be disabled.</i></p>
HEAT COMMAND	Determines how host Heat commands are handled, where:
✧ENABLED	Processes software commands normally.
DISABLED	Controls Heat via the menu setting; see Section 4.2.2.
SPEED COMMANDS	Determines how host Print, Feed, Reverse, and Slew commands are handled, where:
✧ENABLED	Processes software commands normally.
DISABLED	Controls speeds via the menu setting; see Section 4.2.2.
TOF SENSING COMMANDS	Determines how host Gap, Continuous, and Reflective commands are handled, where:
✧ENABLED	Processes software commands normally.
DISABLED	Controls the Sensor Type via the menu setting; see Section 4.2.2.
SYMBOL SET COMMAND	Determines how host Single and Double Symbol Set commands are handled, where:
✧ENABLED	Processes software commands normally.
DISABLED	Controls Symbol Set selection via the menu setting; see Section 4.2.4.

Communications (continued)

Menu Item	Details
CNTRL-CODES (DATA)	Determines how host Control Codes are handled, where:
✧ENABLED	Processes software commands normally.
DISABLED	Controls the setting via the menu; see CONTROL CODES, above.
STX-V SW SETTINGS	Determines how a host option enable command is handled, where:
✧ENABLED	Processes the command normally.
DISABLED	Controls settings via the menu; see Section 4.2.3.
MAX LENGTH COMMAND	Determines how a host Maximum Label Length (<STX>M) command is handled, where:
✧ENABLED	Processes software commands normally.
DISABLED	Controls the setting via the menu; see Section 4.2.1.
OPTION FEEDBACK	<p>Allows feedback characters from an optional device to be returned to the host device, in the format of <A;B;C;D;E;F>[CR], where:</p> <hr/> <p>A - Is the device type: R = RFID; and, S = Linear Scanner</p> <p>B - Is the status: C = entire label complete; F = faulted (failed) label; and, U = unknown</p> <p>C - Is the number of expected reads, given in two characters.</p> <p>D - Is the number of good reads, given in two characters.</p> <p>E - Is the internal Job and Sub Job Identifier, given in four characters each.</p> <p>F - Is the data read, delimited with semicolons (;) if multiple reads.</p> <hr/>
✧DISABLED	Reports no data.
SCANNER	Reports Linear Scanner data.
RFID HEX	Reports RFID data in hexadecimal format.
RFID ASCII	Reports RFID data in an ASCII format.

Communications (continued)

Menu Item	Details
PROCESS SOH (DATA)	Determines the response to an Immediate Command (e.g., Get Status, Module Storage, etc.), where:
✧DISABLED	Processes commands normally.
ENABLED	Interrupts operations upon SOH receipt to process the command.

4.2.6 Diagnostics

The Diagnostics menu contains testing functions:

Menu Item	Details
HEX DUMP MODE	Determines how the printer handles host data, where:
✧DISABLED	Processes data normally.
ENABLED	Prints received ASCII data without interpretation or processing; see Section 6.2.
FILE CAPTURE	Saves received data to Module G (or Module H, if present) in the form <code>dmx_xxx_yyy.dpl</code> where the count (yyy) is incremented for every capture and a unique time stamp (xxx) is assigned.
OPTIONS TESTING	Performs option diagnostics, where:
TEST PRESENT SENSOR	Tests the Present Sensor (including the sensor in the Peel & Present option), where:
LABEL PRESENTED	Is displayed when the sensor is blocked.
LABEL NOT PRESENTED	Is displayed when the sensor is not blocked.
TEST CUTTER	Tests the Cutter, where:
PERFORM TEST 001 TIMES	Selects the number of cuts (1 – 999) to perform and then displays the PASS / FAIL results for each attempt.

Diagnostics (continued)

Menu Item	Details																																
TEST REWINDER	Tests the Powered Internal Rewinder, where:																																
PERFORM TEST 001 TIMES	Selects the number of rotations (0 - 999) to perform and then displays the PASS / FAIL results for each attempt. <input checked="" type="checkbox"/> <i>Remove media from the rewriter before testing.</i>																																
TEST GPIO	Tests the Applicator Interface Card's GPIO function, where:																																
MONITOR GPIO INPUT <table border="1" data-bbox="302 726 659 884"> <tr> <td>SOP</td> <td>FEED</td> <td>PAUSE</td> <td>REPRT</td> <td></td> <td></td> </tr> <tr> <td>1</td> <td>1</td> <td>1</td> <td>1</td> <td></td> <td></td> </tr> <tr> <td>i1</td> <td>i2</td> <td>i3</td> <td>i4</td> <td>i5</td> <td>i6</td> </tr> <tr> <td>1</td> <td>1</td> <td>1</td> <td>1</td> <td>1</td> <td>1</td> </tr> </table>	SOP	FEED	PAUSE	REPRT			1	1	1	1			i1	i2	i3	i4	i5	i6	1	1	1	1	1	1	Displays input signal logic values for Start of Print (SOP), Feed, Pause, Reprint, and six unassigned input lines. (The values given here are examples only.) <input checked="" type="checkbox"/> <i>Unconnected lines may display a zero or one.</i>								
SOP	FEED	PAUSE	REPRT																														
1	1	1	1																														
i1	i2	i3	i4	i5	i6																												
1	1	1	1	1	1																												
TEST GPIO OUTPUT <table border="1" data-bbox="302 978 659 1136"> <tr> <td>EP</td> <td>RL</td> <td>SR</td> <td>MO</td> <td>RO</td> <td>DR</td> <td>OF</td> </tr> <tr> <td>1</td> <td>1</td> <td>1</td> <td>1</td> <td>1</td> <td>1</td> <td>1</td> </tr> <tr> <td>o1</td> <td>o2</td> <td>o3</td> <td>o4</td> <td>o5</td> <td>o6</td> <td></td> </tr> <tr> <td>1</td> <td>1</td> <td>1</td> <td>1</td> <td>1</td> <td>1</td> <td></td> </tr> </table>	EP	RL	SR	MO	RO	DR	OF	1	1	1	1	1	1	1	o1	o2	o3	o4	o5	o6		1	1	1	1	1	1		Displays output signal logic values for End of Print (EP), Ribbon Low (RL), Service Required (SR), Media Out (MO), Ribbon Out (RO), Data Ready (DR), Option Fault (OF), and six unassigned output lines. (The values given here are examples only.) <input checked="" type="checkbox"/> <i>To change an output signal, cursor over the displayed state to select and then toggle it using the UP or Down Arrow Buttons, except Data Ready which cannot be toggled.</i>				
EP	RL	SR	MO	RO	DR	OF																											
1	1	1	1	1	1	1																											
o1	o2	o3	o4	o5	o6																												
1	1	1	1	1	1																												
PRINT SIGNAL INFO	Prints a reference label (see sample below) containing GPIO signal names, pin and port assignments, programmed settings, and current signal states. <div data-bbox="797 1367 1308 1871" style="border: 1px solid black; padding: 5px; margin-top: 10px;"> <p>GPIO SIGNAL INFO WED 11:04AM 4-JUL-2005 CARD IC#3</p> <table border="1"> <thead> <tr> <th colspan="2">OUTPUT SIGNALS</th> <th colspan="2">INPUT SIGNALS</th> </tr> </thead> <tbody> <tr> <td>END OF PRINT PIN# 11 GPIO A LOW PULSE CURRENT LEVEL 1</td> <td>o1 PIN# 15 GPIO B CURRENT LEVEL 1</td> <td>START OF PRINT PIN# 3 GPIO A ACTIVE HIGH CURRENT LEVEL 1</td> <td>i1 PIN# 13 GPIO B CURRENT LEVEL 1</td> </tr> <tr> <td>RIBBON LOW PIN# 9 GPIO A ACTIVE LOW CURRENT LEVEL 0</td> <td>o2 PIN# 10 GPIO B CURRENT LEVEL 0</td> <td>FEED PIN# 4 GPIO A ACTIVE LOW CURRENT LEVEL 1</td> <td>i2 PIN# 8 GPIO B CURRENT LEVEL 0</td> </tr> <tr> <td>SERVICE REQUIRED PIN# 10 GPIO A ACTIVE LOW CURRENT LEVEL 1</td> <td>o3 PIN# 5 GPIO B CURRENT LEVEL 1</td> <td>TOGGLE PAUSE PIN# 5 GPIO A ACTIVE LOW CURRENT LEVEL 1</td> <td>i3 PIN# 3 GPIO B CURRENT LEVEL 1</td> </tr> <tr> <td>MEDIA OUT PIN# 12 GPIO A ACTIVE LOW CURRENT LEVEL 1</td> <td>o4 PIN# 14 GPIO B CURRENT LEVEL 1</td> <td>REPRINT PIN# 6 GPIO A ACTIVE LOW CURRENT LEVEL 1</td> <td>i4 PIN# 12 GPIO B CURRENT LEVEL 1</td> </tr> <tr> <td>RIBBON OUT PIN# 13 GPIO A ACTIVE LOW CURRENT LEVEL 1</td> <td>o5 PIN# 9 GPIO B CURRENT LEVEL 1</td> <td></td> <td>i5 PIN# 7 GPIO B CURRENT LEVEL 1</td> </tr> <tr> <td>DATA READY PIN# 14 GPIO A ACTIVE LOW CURRENT LEVEL 1</td> <td>o6 PIN# 4 GPIO B CURRENT LEVEL 1</td> <td></td> <td>i6 PIN# 2 GPIO B CURRENT LEVEL 1</td> </tr> <tr> <td>OPTION FAULT PIN# 15 GPIO A ACTIVE LOW CURRENT LEVEL 1</td> <td></td> <td></td> <td></td> </tr> </tbody> </table> </div>	OUTPUT SIGNALS		INPUT SIGNALS		END OF PRINT PIN# 11 GPIO A LOW PULSE CURRENT LEVEL 1	o1 PIN# 15 GPIO B CURRENT LEVEL 1	START OF PRINT PIN# 3 GPIO A ACTIVE HIGH CURRENT LEVEL 1	i1 PIN# 13 GPIO B CURRENT LEVEL 1	RIBBON LOW PIN# 9 GPIO A ACTIVE LOW CURRENT LEVEL 0	o2 PIN# 10 GPIO B CURRENT LEVEL 0	FEED PIN# 4 GPIO A ACTIVE LOW CURRENT LEVEL 1	i2 PIN# 8 GPIO B CURRENT LEVEL 0	SERVICE REQUIRED PIN# 10 GPIO A ACTIVE LOW CURRENT LEVEL 1	o3 PIN# 5 GPIO B CURRENT LEVEL 1	TOGGLE PAUSE PIN# 5 GPIO A ACTIVE LOW CURRENT LEVEL 1	i3 PIN# 3 GPIO B CURRENT LEVEL 1	MEDIA OUT PIN# 12 GPIO A ACTIVE LOW CURRENT LEVEL 1	o4 PIN# 14 GPIO B CURRENT LEVEL 1	REPRINT PIN# 6 GPIO A ACTIVE LOW CURRENT LEVEL 1	i4 PIN# 12 GPIO B CURRENT LEVEL 1	RIBBON OUT PIN# 13 GPIO A ACTIVE LOW CURRENT LEVEL 1	o5 PIN# 9 GPIO B CURRENT LEVEL 1		i5 PIN# 7 GPIO B CURRENT LEVEL 1	DATA READY PIN# 14 GPIO A ACTIVE LOW CURRENT LEVEL 1	o6 PIN# 4 GPIO B CURRENT LEVEL 1		i6 PIN# 2 GPIO B CURRENT LEVEL 1	OPTION FAULT PIN# 15 GPIO A ACTIVE LOW CURRENT LEVEL 1			
OUTPUT SIGNALS		INPUT SIGNALS																															
END OF PRINT PIN# 11 GPIO A LOW PULSE CURRENT LEVEL 1	o1 PIN# 15 GPIO B CURRENT LEVEL 1	START OF PRINT PIN# 3 GPIO A ACTIVE HIGH CURRENT LEVEL 1	i1 PIN# 13 GPIO B CURRENT LEVEL 1																														
RIBBON LOW PIN# 9 GPIO A ACTIVE LOW CURRENT LEVEL 0	o2 PIN# 10 GPIO B CURRENT LEVEL 0	FEED PIN# 4 GPIO A ACTIVE LOW CURRENT LEVEL 1	i2 PIN# 8 GPIO B CURRENT LEVEL 0																														
SERVICE REQUIRED PIN# 10 GPIO A ACTIVE LOW CURRENT LEVEL 1	o3 PIN# 5 GPIO B CURRENT LEVEL 1	TOGGLE PAUSE PIN# 5 GPIO A ACTIVE LOW CURRENT LEVEL 1	i3 PIN# 3 GPIO B CURRENT LEVEL 1																														
MEDIA OUT PIN# 12 GPIO A ACTIVE LOW CURRENT LEVEL 1	o4 PIN# 14 GPIO B CURRENT LEVEL 1	REPRINT PIN# 6 GPIO A ACTIVE LOW CURRENT LEVEL 1	i4 PIN# 12 GPIO B CURRENT LEVEL 1																														
RIBBON OUT PIN# 13 GPIO A ACTIVE LOW CURRENT LEVEL 1	o5 PIN# 9 GPIO B CURRENT LEVEL 1		i5 PIN# 7 GPIO B CURRENT LEVEL 1																														
DATA READY PIN# 14 GPIO A ACTIVE LOW CURRENT LEVEL 1	o6 PIN# 4 GPIO B CURRENT LEVEL 1		i6 PIN# 2 GPIO B CURRENT LEVEL 1																														
OPTION FAULT PIN# 15 GPIO A ACTIVE LOW CURRENT LEVEL 1																																	

Diagnostics (continued)

Menu Item	Details
TEST SCANNER	Tests the Linear Scanner, where:
ALIGNMENT TEST	Reads a bar code then displays the decoded data, the code type and scan count, repeating.
SCAN TEST	Reads a bar code then displays the decoded data, the code type and scan count, non-repeating.
TEST RFID	Tests RFID, where:
TAG DATA	Reads the data encoded on a tag.
DEVICE VERSION	Displays the type and version of the encoding device.
TAG ID – HF ONLY	Reads then displays the High Frequency Tag ID.
PRINT TEST RATE (min)	Allows a label-to-label delay when batch printing Test Labels, where:
(0 – 120) ◇000	Is the selected interval, in minutes.
SENSOR READINGS	Displays various sensor values (0 – 255), where:
THR TRAN RIBM 24V 127 159 093 175 PS HD RANK 000 254 125	Are readings for the printhead thermistor sensor (THR), media “gap” sensor (TRAN) or “reflective” sensor (REFL), ribbon sensor (RIBM), 24VDC power supply sensor (24V), present sensor (PS), printhead assembly sensor (HD) and, printhead ranking resistor (RANK). (The values given here are examples only.)
RIBBON SENSOR LIMITS	Displays ribbon sensor values (0 – 255) for thermal transfer equipped printers, where:
RIBBON ADC LOW 9 RIBBON ADC HIGH 245	Are the sensor readings. (The values given here are examples only.)
iPH REPORT	Displays the IntelliSEAQ™ data (including the printhead serial number, and installation and maintenance dates), where:
VIEW	Displays the data.

Diagnostics (continued)

Menu Item	Details
PRINT	Prints the data: <div style="border: 1px solid black; padding: 5px; margin-top: 5px;"> <pre>IPH REPORT TUE 12:44PM 23MAY2006 4212-HE25-060224-090 PRINthead SERIAL #: 5x-00289 PRINthead MODEL # 163 PRINTER SERIAL # 60430014 PRINthead INCHES 1334900 INSTALLATION DATE - INITIAL 02/02/2006 INSTALLATION DATE - LAST 08/06/2006 PRINthead CLEANING CLEAN PROCEDURES: 5 CLEAN COUNTER RESET 5 NUMBER OF INCHES LAST- 0</pre> </div>
SAVE	Saves the data to an external storage device; see Section 2.2.3.
ICON DESCRIPTIONS	Identifies the printer icons (see Section 4.1.1), where:
SYSTEM ICONS	Displays system glyphs.
NETWORK ICONS	Displays network glyphs.
INPUT TYPE ICONS	Displays input mode glyphs.
OPTIONS ICONS	Displays detected option glyphs.

4.2.7 MCL Options

The MCL Options menu contains alternate operating selections:

Menu Item	Details
MCL OPTIONS	Allows the printer to use the optional MCL tool suite to accept peripheral device input data, where:
MCL AT POWER-UP	Allows MCL start-up, where:
ENABLED	Sets MCL operation after power is cycled OFF and ON.
◇DISABLED	Sets standard printer functions.
START MCL	Starts MCL after exiting the menu.



Consult your MCL provider for details regarding operation and support.

4.3 The Test Menu

The (Quick) Test Menu contains resident format selections that are printed at selected heat and speed settings. Use full width media to capture the entire format; otherwise, adjust the printer and set the Label Width.

To enter the Test Menu, press the TEST Button.

(In Test Mode the printer is offline, halting the processing of new data.)



Menu, Test, and Navigation Buttons



- To print a format, scroll to that item then input a quantity and press ENTER.
- To stop printing press CANCEL.
- A printing delay can be set; see *Print Test Rate*, Section 4.2.6.

4.3.1 Print Quality Label

The Print Quality Label serves as an overall quality indicator. Consisting of compliant fence and ladder bar codes, assorted font sizes, and fill patterns, this format can be used to ensure conformance as well as aesthetics.

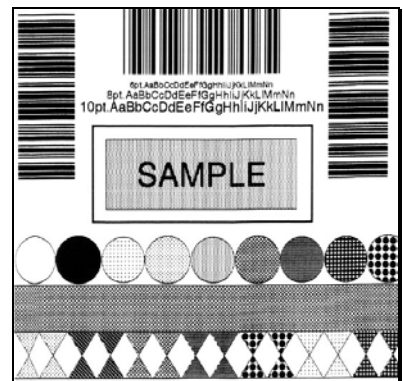

4.3.2 Ribbon Test Label

The Ribbon Test Label serves as a transfer function indicator for printers equipped with the thermal transfer option. Consisting of a fence-oriented bar code, this format can be used to ensure component functions and ribbon path alignment.

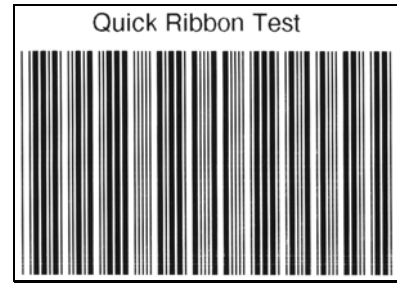

4.3.3 Test Label

The Test Label serves as an indicator of printhead functionality. The format consists of patterns that exercise all thermal elements.

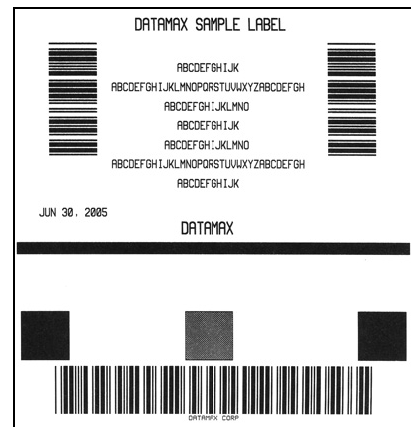

4.3.4 Validation Label

The Validation Label serves as an overall quality indicator. Consisting of compliant fence and ladder bar codes, assorted font sizes, and black fill patterns, this format can be used to ensure conformance as well as aesthetics.

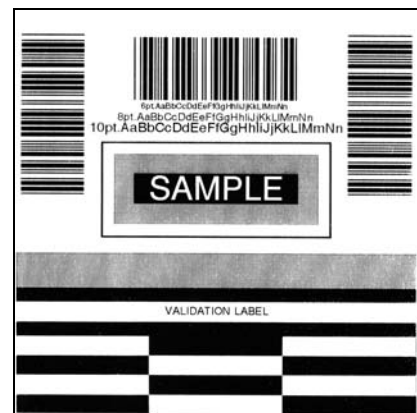

4.3.5 Print Configuration

The Configuration Label provides current database information, including the Application Version, which can be output as a label or as a file.



Bulleted items indicate host changes not yet saved.

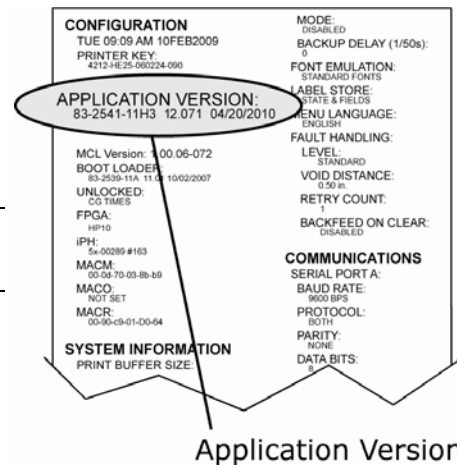

4.3.6 Print Last Label

Print Last Label reprints the most recent format output by the printer.



If a job was cancelled prior to completion, or if power was removed since the last print job and this label request, VOID will be printed.

4.3.7 User-Defined Label

The User-Defined Label allows a template to be populated by variable data (via the printer's control panel or a USB QWERTY keyboard). The template is a stored label format, where fields delimited by an ampersand (&) become variable.

The printer will prompt you to enter the variable field data. For example, the stored label format could contain the data 19131423443&ENTER NAME&

Afterward, when recalled from memory, the printer's display will indicate the variable field:
ENTER NAME



- *Variable data can be any part of the DPL format - font ID, positioning, etc.*
- *No error checking will be performed.*
- *Supports .dlb, .dpl, .prn, and .txt file types.*

5 *Operating, Adjusting and Maintaining the Printer*

5.1 *Displayed Messages*

During operation the printer (when not in Menu or Test Mode) displays several types of information:

- Prompts and Condition Messages (see Section 5.1.1); and,
- Fault and Warning Messages (see Section 6.1.2).

5.1.1 *Prompts and Condition Messages*

Prompts appear as the result of an action or when an action is required during operation, while Condition Messages indicate an operational state.

Prompts and Condition Messages		
Displayed Message	Description	Action / State
ACCESS DENIED	The password used to access a secured menu was incorrect.	Enter the correct password.
CALIBRATING SENSOR LEVELS	Media calibration is being performed.	Allow the process to complete.
CALIBRATION COMPLETE	Media calibration has successfully finished.	The printer is calibrated.
CANCEL BATCH ENTER KEY = YES	The CANCEL or TEST Key was pressed during a multiple label job.	Press ENTER to cancel all remaining labels in the job.
CANCEL REPRINT ENTER KEY = YES	The CANCEL or TEST Key was pressed during a fault. (See FAULT HANDLING / VOID AND RETRY, Section 4.2.4.)	Press ENTER to cancel the reprint.

Prompts and Condition Messages <i>(continued)</i>		
Displayed Message	Description	Action / State
CLEARING FAULTS	The FEED Key was pressed following a fault and now the printer is attempting to clear the condition.	No action is required.
DMXNET INITIALIZING	The network card is initializing, a normal condition following power-up or a reset.	No action is required. Depending upon the settings, it may take a few minutes.
ENTER PASSWORD 0 - - -	This is the menu gateway when security is enabled. A four-digit password must be entered for access.	Enter the correct password.
INVALID ENTRY	An incorrect entry has been made.	Enter a valid parameter to continue.
NOT INSTALLED	The selected option or feature cannot be found.	Verify that the option or feature is correctly installed. If so, call for service.
OFFLINE	The printer is in Menu or Test Mode.	The Menu or Test Button was pressed.
PAUSED	The printer is in a paused condition.	The PAUSE Key was pressed or Pause Mode is enabled.
PRINthead CLEANING	The TEST Key was pressed and held, or CLEAN HEAD NOW was selected, and now printhead cleaning is in progress.	No action is required.
READY	The printer is waiting to receive label formats, downloads, etc.	Send a label format, download, etc.

Prompts and Condition Messages <i>(continued)</i>		
Displayed Message	Description	Action / State
REMOVE RIBBON PRESS ANY KEY	The TEST Key was pressed and held, or CLEAN HEAD NOW was selected, but ribbon is installed.	Remove ribbon and press any key to proceed.
SAVE CHANGES?	Database changes were made that require confirmation.	Press YES to accept the changes, or NO to discard them. <hr/> <input checked="" type="checkbox"/> <i>If changes require a reset, it will automatically be invoked.</i> <hr/>
SUCCESSFUL PRESS ANY KEY	The selected operation was successfully completed.	Press any key to continue.
SYSTEM RESET IN PROGRESS	A reset has occurred.	No action is required. Wait briefly while the process completes.
UNCALIBRATED	The Media Sensor is not calibrated.	Perform calibration; see Section 5.2.
WAITING FOR DATA	The SOP signal has been received, but the printer awaits label data.	Send a format from the host.
WAITING FOR SIGNAL	The printer awaits a SOP signal.	Send the SOP signal from the applicator to the GPIO port.
XXXX OF XXXX PRINTING	A print job is in process, as indicated by the batch total and remaining label count.	No action is required.

5.2 Calibration

Calibration ensures correct media detection. Use Standard Calibration if the quick method (see Section 3.4) fails.

5.2.1 Standard Calibration

Standard Calibration provides dynamic readings, which can be helpful when using media with small position-critical notches or marks. Three calibration samples are required:

Empty – with nothing over the sensor;

Gap (or Mark) – with media liner, a notch, or a mark over the sensor; and,

Paper – with the label (and liner, if any) over the sensor.



Calibrate the Media Sensor using the steps below:



Before proceeding, ensure that the ADVANCED MENU is enabled (see Section 4.2.4) and that the SENSOR TYPE is selected (see Section 4.2.1).

Step	Action	Displayed Message	Comment
A	Turn ON the printer.	CANNOT CALIBRATE -or- UNCALIBRATED	Wait briefly for initialization to complete; see Section 4.1.1.
B	Press ENTER to access MEDIA SETTINGS. Then using the UP Button, scroll to SENSOR CALIBRATION.	MEDIA SETTINGS	ADVANCED MENU must be enabled to access the calibration selections.
C	Press ENTER to access SENSOR CALIBRATION. Press ENTER again to select PERFORM CALIBRATION and then press YES to proceed.	PERFORM CALIBRATION	Press NO to abort this procedure.
D	With no media installed, press ESC.	REMOVE LABEL STOCK PRESS ESC KEY yyy	This sets the empty value, where "yyy" represents the current sensor reading.

Standard Calibration (continued)

Step	Action	Displayed Message	Comment
E	<p>Proceed according to the media type:</p> <ul style="list-style-type: none"> • Die-Cut – Remove a label or two from the liner then install the media. Position the Media Sensor under the liner area and press ESC. • Notched (or Reflective) – Install media. Position the Media Sensor under a notch (or black mark) and press ESC. • Continuous – Press ESC then proceed to Step F. 	<p><i>For die-cut media:</i></p> <p>SCAN BACKING PRESS ESC KEY yyy</p> <hr/> <p><i>- Or, for reflective media:</i></p> <p>SCAN MARK PRESS ESC KEY yyy</p> <hr/> <p><i>- Or, for continuous media:</i></p> <p>REMOVE LABEL STOCK PRESS ESC KEY yyy</p>	<p>This sets the gap (or mark) value, where “yyy” represents the current sensor reading.</p> <hr/> <p></p> <p>(1) See Section 3.2 for sensor adjustment instructions.</p> <p>(2) Do not position a perforation over the sensor when taking the sample.</p> <p>(3) For small notches or reflective marks, ensure that the labels exit straight from the printer.</p> <p>(4) Unless otherwise noted, do not move the Media Sensor after this step.</p>
F	<p>Proceed according to the media type:</p> <ul style="list-style-type: none"> • All media except Continuous – Position label material (and liner, if any) over the sensor then press the ESC Key. • Continuous – Install media. Position the Media Sensor under the stock and press ESC. 	<p>SCAN PAPER PRESS ESC KEY yyy</p>	<p>This sets the paper value, where “yyy” represents the current sensor reading.</p> <hr/> <p></p> <p>(1) If using preprinted media, ensure that the area placed over the sensor is free of text, graphics, or borders.</p> <p>(2) See Section 3.2 for sensor adjustment instructions.</p>

Standard Calibration (continued)

Step	Action	Displayed Message	Comment
G	Observe the calibration result.	CALIBRATION COMPLETE	<p>Calibration was successful.</p> <hr/> <p> If WARNING LOW BACKING is displayed, calibration was successful (for possible messages see Section 5.1).</p> <hr/>
H	<p>Press ESC then EXIT to return to READY.</p> <p>When calibrating gap or reflective media, press and hold the FEED Key until at least one label is output.</p>	<p>CALIBRATION COMPLETE</p> <p><i>Followed by...</i></p> <p>READY</p>	<p>The printer is now ready for use.</p>

5.2.2 Advanced Entry Calibration

Advanced Entry is an alternate calibration method for special-case media types, where sensor readings are taken using different sampling algorithms and from a list of these readings the best algorithm is selected for manual entry into the database.



*Advanced Entry Calibration should be used only when Standard Calibration proves unsuccessful. Also, before proceeding, ensure that the **ADVANCED MENU** is enabled (see Section 4.2.4) and that the **SENSOR TYPE** is selected (see Section 4.2.1).*

Calibrate the Media Sensor using the steps below:

Advanced Entry Calibration

Step	Action	Displayed Message	Comment
A	Turn ON the printer.	CANNOT CALIBRATE -or- UNCALIBRATED	Wait briefly for initialization to complete; see Section 4.1.1.
B	Press ENTER to access MEDIA SETTINGS. Then using the UP Button, scroll to SENSOR CALIBRATION.	MEDIA SETTINGS	ADVANCED MENU must be enabled to access the calibration selections.
C	Press ENTER to access SENSOR CALIBRATION. Using the DOWN Button, highlight ADVANCED ENTRY then press ENTER.	ADVANCED ENTRY	Press EXIT to abort this procedure.
D	Scroll to TRAN SENSOR GAIN (or REFL SENSOR GAIN, if using reflective media) then press ENTER.	TRAN SENSOR GAIN yyy (0 - 31) 25	The following examples detail die-cut media calibration; however, unless otherwise noted, the reflective media procedure is the same.
E	Install media. Position the Media Sensor under the label, then lower and latch the Printhead Assembly.	TRAN SENSOR GAIN yyy (0 - 31) 25	See Section 3.2 for sensor adjustment instructions. <input checked="" type="checkbox"/> <i>Do not position the Media Sensor under a perforation; and if using preprinted media, ensure the label area placed over the sensor is free of text, graphics, lines, etc.</i>

Advanced Entry Calibration (continued)

Step	Action	Displayed Message	Comment
F	Use the buttons to set the Gain Number to 00 and then press ENTER. Record the sensor reading as a Label Value for Gain Number 00 in a table (32 rows by four columns, with headings similar to those shown below.)	TRAN SENSOR GAIN yyy (0 - 31) 00	This is the Label Value for a gain setting of 00, where "yyy" represents the current sensor reading.

<i>Sample Calibration Table</i>			
<i>Gain Number</i>	<i>Label Value</i>	<i>TOF Value</i>	<i>Difference Value</i>
00	252		
01			
02			
...			
31			

Step	Action	Displayed Message	Comment
G	Use the buttons to increment the Gain Number by one and then press ENTER. Record the Label Value. Repeat this process for each Gain Number.	TRAN SENSOR GAIN yyy (0 - 31) 01	These are Label Values, where "yyy" represents the current sensor reading.

<i>Sample Calibration Table</i>			
<i>Gain Number</i>	<i>Label Value</i>	<i>TOF Value</i>	<i>Difference Value</i>
00	252		
01	250		
02	248		
...	...		
31	09		

Advanced Entry Calibration (continued)

Step	Action	Displayed Message	Comment
H	<p>Raise the printhead assembly then proceed according to the media type:</p> <ul style="list-style-type: none"> • Die-cut – Remove a label or two from the liner then position that area over the Media Sensor. Adjust the Media Sensor under the liner area. • Notched – Position the Media Sensor under the notch. • Reflective – Position the Media Sensor under the black mark. 	<p>TRAN SENSOR GAIN</p> <p>yyy (0 - 31) 31</p>	<p></p> <p>(1) Do not position the Media Sensor under a perforation; and if using preprinted media, ensure the label area placed over the sensor is free of text, graphics, lines, etc.</p> <p>(2) Do not move the Media Sensor after this step.</p>
I	<p>Lower and latch the Printhead Assembly.</p> <p>Using the buttons set the Gain Number to 00, and then press ENTER.</p> <p>Record the reading as a TOF Value for Gain Number 00 in the table.</p>	<p>TRAN SENSOR GAIN</p> <p>yyy (0 - 31) 00</p>	<p>This is the TOF Value for a gain setting of 00, where “yyy” represents the current sensor reading.</p>

Gain Number	Label Value	TOF Value	Difference Value
00	252	248	
01	250		
02	248		
...	...		
31	09		

Advanced Entry Calibration (continued)

Step	Action	Displayed Message	Comment
J	Use the buttons to increment the Gain Number by one and then press ENTER. Record the TOF Value. Repeat this process for each Gain Number.	TRAN SENSOR GAIN YYY (0 - 31) 01	These are TOF Values, where "yyy" represents the current sensor reading.

Gain Number	Label Value	TOF Value	Difference Value
00	252	248	
01	250	245	
02	248	234	
...	
31	09	14	

Step	Action	Displayed Message	Comment
K	In your sample calibration table, where both the Label Value and TOF Value are at least 20, subtract the amounts and record the result as a Difference Value (see below). Identify the largest Difference Value and the corresponding Gain Number. This Gain Number will be used to resample the media.	TRAN SENSOR GAIN YYY (0 - 31) 31	In this example, Gain Number 18 is chosen because, where both values are at least twenty, it has the highest Difference Value.

Gain Number	Label Value	TOF Value	Difference Value
00	252	248	4
01	250	245	5
02	248	234	14
...
15	188	63	125
16	184	51	133
17	179	38	141
18	174	25	149
19	170	19	N/A
...
31	132	14	N/A

Advanced Entry Calibration (continued)

Step	Action	Displayed Message	Comment
L	Use the buttons to set the Gain Number determined in the previous step. Press ENTER to enable the setting.	<p>TRAN SENSOR GAIN</p> <p>yyy (0 - 31) 18</p>	This example uses Gain Number 18.
M	<p>Complete a table (see example below) using new measurements, as follows:</p> <p>(A) Raise the Printhead Assembly. Place the label over the Media Sensor then lower and latch the Printhead Assembly. Record the sensor reading as P.</p> <p>(B) Raise the Printhead Assembly. Place the liner, notch, or mark over the Media Sensor then lower and latch the Printhead Assembly. Record the sensor reading as G (or M).</p> <p>(C) Raise the Printhead Assembly. Remove all media from the Media Sensor then lower and latch the Printhead Assembly. Record the sensor reading as E.</p>	<p>TRAN SENSOR GAIN</p> <p>yyy (0 - 31) 18</p>	<p>Where "yyy" is a numerical value representing the current sensor reading.</p> <hr/> <p><input checked="" type="checkbox"/> <i>The re-sampled values may differ from those previously noted. This is normal; do not readjust the Media Sensor.</i></p>

Gain Number	Paper	Gap (or Mark)	Empty
18	173	42	9

Advanced Entry Calibration (continued)

Step	Action	Displayed Message	Comment
N	<p>Press the ESC Key.</p> <p>Use the buttons to scroll to PAPER SENSOR LEVEL (or if using reflective media, REFL PAPER LEVEL) and then press ENTER.</p> <p>Use the buttons to set the Paper value determined in Step M and then press ENTER.</p>	<p>PAPER SENSOR LEVEL</p> <p>(0 - 255) 173</p>	<p>This is the Paper value.</p>
O	<p>Press the ESC Key.</p> <p>Scroll to GAP SENSOR LEVEL (or, if using reflective media, MARK SENSOR LEVEL) and then press ENTER.</p> <p>Set the Gap (or Mark) value determined in Step M and then press ENTER.</p>	<p>GAP SENSOR LEVEL</p> <p>(0 - 255) 042</p>	<p>This is the Gap (or Mark) value.</p>
P	<p>Press the ESC Key.</p> <p>Scroll to EMPTY SENSOR LEVEL and then press ENTER.</p> <p>Set the Empty value determined in Step M and then press ENTER.</p>	<p>EMPTY SENSOR LEVEL</p> <p>(0 - 255) 009</p>	<p>This is the Empty value.</p>
Q	<p>Press the EXIT Key and, when prompted, press YES at the SAVE CHANGES prompt.</p>	<p>OFFLINE</p>	<p>The procedure is finished, the process almost complete.</p>

Advanced Entry Calibration (continued)

Step	Action	Displayed Message	Comment
R	Press and hold the FEED Key until at least one label has been output.	CALIBRATION COMPLETE Followed by... READY	<p>The printer is ready for use.</p> <hr/> <p>✔ If the calibration attempt fails, try desensitizing the sensor as follows:</p> <p>Re-enter the ADVANCED MENU. Go to MEDIA SETTINGS / SENSOR CALIBRATION / ADVANCED ENTRY / TRAN (or REFL) SENSOR GAIN and lower the corresponding GAIN SETTING by one. Exit the menu and save your changes. Test your media at the new setting. If necessary, repeat until a usable Gain Setting is obtained.</p> <hr/>

5.3 Reset Methods

There are three reset levels for the printer.

5.3.1 Soft Reset

Soft Reset clears temporary host settings. To perform a Soft Reset:

- Press and hold the CANCEL Key (see Section 4.1) for approximately four seconds.

5.3.2 Level One Reset

Level One reset returns the factory default settings, or if saved a Factory Setting File. To perform a Level One Reset:

- Select SET FACTORY DEFAULTS in the menu; see Section 4.2.4.

5.3.3 Level Two Reset

Level Two reset returns the printer to the firmware default settings and clears all parameters. To perform a Level Two Reset:

- While turning ON the printer, press and hold the three Soft Keys (see Section 4.1) until the SYSTEM RESET message flashes.



Calibration will be required; see Section 5.2.

5.4 Printhead Assembly Adjustments

Printhead Assembly Adjustments permit the mechanical compensation sometimes needed to maintain print quality across the wide range of media types and sizes. The applicability and adjustment methods for the printhead are described below.

5.4.1 Leveling Cam Adjustment

Whenever using narrow media (sizes that are less than the width of the printhead), adjust the Leveling Cam for even pressure distribution.



If changing media sizes, readjust the Leveling Cam.



Adjust the Printhead Leveling Cam as follows:

- A. With media loaded, download your label format (or use a Test Menu format) then begin printing a small batch of labels.
- B. While observing the printed output, rotate the Leveling Cam counter-clockwise until the image fades across the label, as shown in Example 1 (below).
- C. While observing the printed output, rotate the Leveling Cam clockwise until the image is complete, with even contrast, as shown in Example 2 (below).

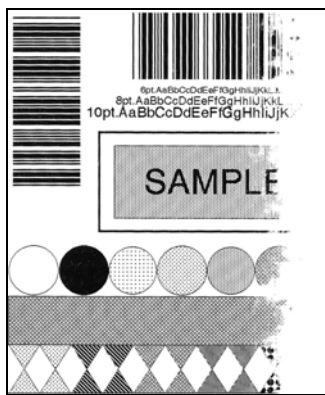

Example 1 – Too much adjustment

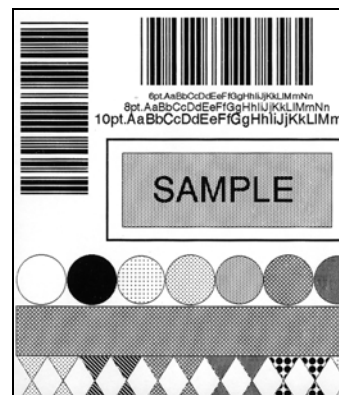

Example 2 – Correct adjustment



Under-adjustment of the Leveling Cam can cause problems that include ribbon wrinkling, label tracking, and excessive platen and printhead wear.

5.4.2 Printhead Pressure Adjustment

Printhead Pressure Adjustment should only be performed after attempting to improve print quality through the use of other print quality controls (see Section 3.5).

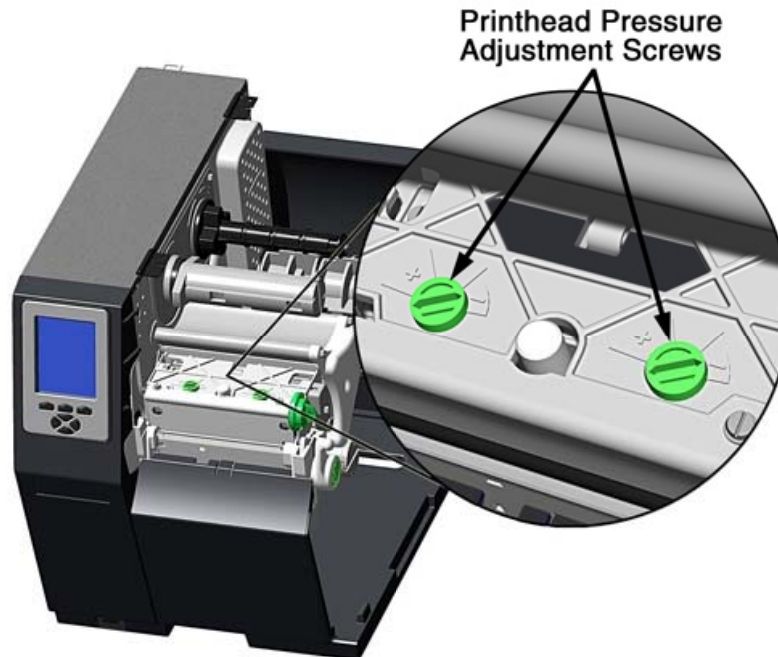

- A. With media loaded, download your label format (or use a Test Menu format) then begin printing a small batch of labels.
- B. While observing the printed output, turn each Pressure Adjustment Screw (use a small coin or screwdriver) by the same amount until the image is complete, with even contrast:
 - Counterclockwise (+) to increase applied pressure, or;
 - Clockwise (-) to decrease applied pressure.



Ensure that each arrow points in the same direction.

5.5 Maintenance

This section details the recommended maintenance supplies, schedules, and methods.

Supplies

These items will help to safely and effectively clean the printer:

- Isopropyl alcohol
- Cotton swabs
- Clean, lint-free cloth
- Lens tissue
- Soft-bristle brush
- Soapy water/mild detergent
- Compressed air
- Printhead Cleaning Cards or Printhead Cleaning Film
- Vacuum Cleaner

Schedule

The following table details the recommended cleaning schedules:

Recommended Cleaning Schedule*		
Component / Area	Cleaning Interval**	Supplies / Method
Exterior Surfaces	As needed, based on a weekly visual inspection.	Mild detergent applied with a dampened cloth; see Section 5.5.7.
Fan Filter (tall models only)	As needed, based on a weekly visual inspection.	Vacuum; see Section 5.5.2.
Interior Compartment	As needed, based on a weekly visual inspection.	Compressed air or a soft brush; see Section 5.5.3.
Media Sensing Components	As needed, based on a weekly visual inspection.	Compressed air, soft brush, lens tissue and / or isopropyl alcohol; see Section 5.5.4.
Platen and Assist Rollers	After each roll of media or ribbon; sooner if needed.	Cotton swab or a cloth dampened with isopropyl alcohol; see Section 5.5.5.
Printhead	Varies according to the media type: <ul style="list-style-type: none"> • Thermal transfer media – after each roll of ribbon. • Direct thermal media – after each roll of media, or as needed. 	Isopropyl alcohol, and if necessary Cleaning Cards or Cleaning Film; see Section 5.5.1.
Ribbon Path Components (equipped models only)	As needed, based on a weekly visual inspection.	Cotton swab or a cloth dampened with isopropyl alcohol; see Section 5.5.6.

*For optional equipment, refer to the documentation that accompanied the item(s).

**Whichever interval comes first.

5.5.1 Cleaning the Printhead



Never use a sharp, hard or abrasive object on the printhead.

If print quality declines (symptoms can include unreadable bar codes or streaks through text and graphics), the typical cause is debris buildup on the printhead which, left unattended, can lead to premature dot failure. To help you remember this important procedure, the printer can be programmed to prompt you for cleaning; see Section 4.2.1. Depending upon the supplies and printing parameters used, different cleaning methods are recommended.

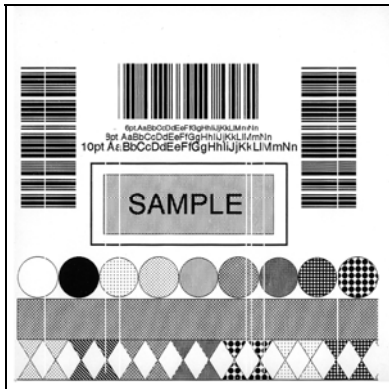

✓ Streaks can indicate a dirty or faulty printhead.

Proper cleaning is critical. To maintain peak performance of the printer, Datamax-O'Neil offers a complete line of cleaning products including pens, cards, films and swabs. Visit our website at <http://www.datamax-oneil.com> to learn more. **Certified Datamax-O'Neil – The worry free choice for optimal printer performance.**

Cotton Swab Procedure (for users of direct thermal media, or thermal transfer media with wax ribbon):

- A. Turn OFF the Power Switch and unplug the printer. Raise the cover, then raise the Printhead Assembly and **wait briefly for the printhead to cool.**
- B. Remove media and ribbon. Using a Cotton Swab moistened (not soaked) with isopropyl alcohol, thoroughly clean the printhead.

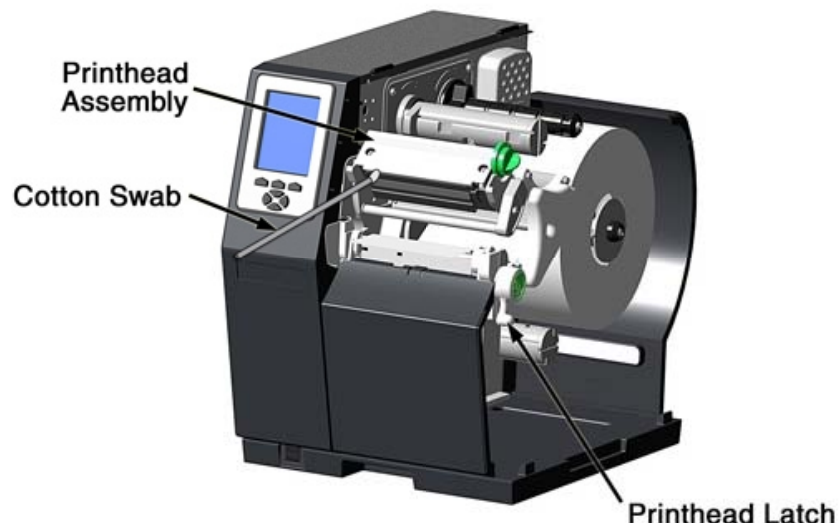

- C. Allow the printhead to dry. Reinstall media (and ribbon, if needed). Plug in the printer and turn ON the Power Switch. Run a few sample labels and examine them. If streaking is still present, use Cleaning Card Procedure, below; otherwise, this completes cleaning. If the CLEAN HEAD SCHEDULE has been set, enter the menu and select RESET COUNTER; see Section 4.2.1.

Cleaning Card Procedure *(for users of direct thermal media, or thermal transfer media with wax/resin ribbon combinations; also for unsuccessful Cotton Swab cleaning attempts):*

- A. Raise the cover, then raise the Printhead Assembly and **wait briefly for the printhead to cool.**
- B. Remove media and ribbon then place a Cleaning Card under the printhead. (Part number 70-2013-01 for 4-inch cards; and, 70-2014-01 for 6-inch cards)
- C. Close and lock the Printhead Latch and disengage the Leveling Cam.
- D. Close the cover then press and hold the TEST Button to initiate cleaning. (As an alternate, select CLEAN HEAD NOW see Section 4.2.1.)
- E. After the cleaning card has been run through the printer, reinstall media (and ribbon, if needed). Plug in and turn ON the printer. Run a few sample labels and examine them. If streaking is still present, use the Cleaning Film Procedure, below; otherwise, this completes cleaning.

Cleaning Film Procedure *(for users of thermal transfer media and resin ribbon, when printing with a Heat Value of 22 or higher, or when other methods prove unsuccessful):*

- A. Raise the cover, then raise the Printhead Assembly and **wait briefly for the printhead to cool.**
- B. Remove media and ribbon then place a sheet of Cleaning Film under the printhead. (Part number 70-2087-01 for 4-inch film; 70-2087-02 for 6-inch film; and, 70-2087-03 for 8-inch film)
- C. Close and lock the Printhead Latch and disengage the Leveling Cam.
- D. Close the cover then press and hold the TEST Button to initiate cleaning. (As an alternate, select CLEAN HEAD NOW see Section 4.2.1.)
- E. After the cleaning film has been run through the printer, turn OFF the Power Switch and unplug the printer. Open the cover then raise the Printhead Assembly and **wait briefly for the printhead to cool.** Using a cotton swab moistened (not soaked) with isopropyl alcohol, clean the printhead then allow it to dry.
- F. Reinstall media (and ribbon, if needed). Plug in and turn ON the printer. Run a few sample labels and examine them. If streaking is still present the printhead may need to be replaced; see Section 5.9.

5.5.2 *Cleaning the Fan Filter*

On equipped models, a Fan Filter keeps dust and debris from entering the printer. To assure continued airflow through the printer, clean the Fan Filter as follows:



- A. Turn OFF the Power Switch and unplug the power cord from the AC Receptacle.
- B. Using a vacuum, clean the Fan Filter.

5.5.3 *Cleaning the Interior Compartment*

Inside the printer, paper dust from the media can accumulate to produce small voids in the print. To assure continued void free printing, clean the Interior Compartment as follows:

- A. Turn OFF the Power Switch and unplug the power cord from the AC Receptacle.
- B. Raise the Cover then remove media and ribbon.
- C. Remove all media and ribbon.
- D. Using compressed air (or a soft brush), clean all debris from Interior Compartment.

5.5.4 *Cleaning the Media Sensing Components*

Paper dust and adhesive from the media can accumulate on the sensing components and produce TOF problems. To avoid problems, clean the Media Sensor and Light Bar as follows:

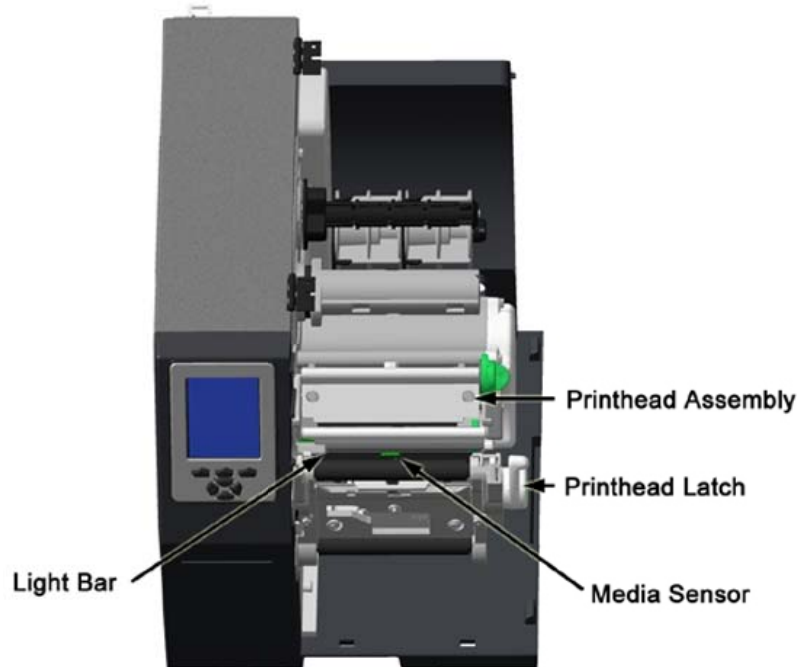

- A. Turn OFF the Power Switch and unplug the power cord from the AC Receptacle.
- B. Unlock the Printhead Latch, raise the Printhead Assembly, and remove media.
- C. Using compressed air, clean all debris from the Media Sensor and the Light Bar. (In cases of extreme buildup, a Cotton Swab or lens tissue dampened with isopropyl alcohol can be used.)

5.5.5 *Cleaning the Platen and Assist Rollers*

Rollers contaminated with grit, label adhesive, or ink can lead to a decline in print quality and, in extreme cases, cause labels to adhere and wrap the roller. Clean the Platen and Assist Rollers as follows:

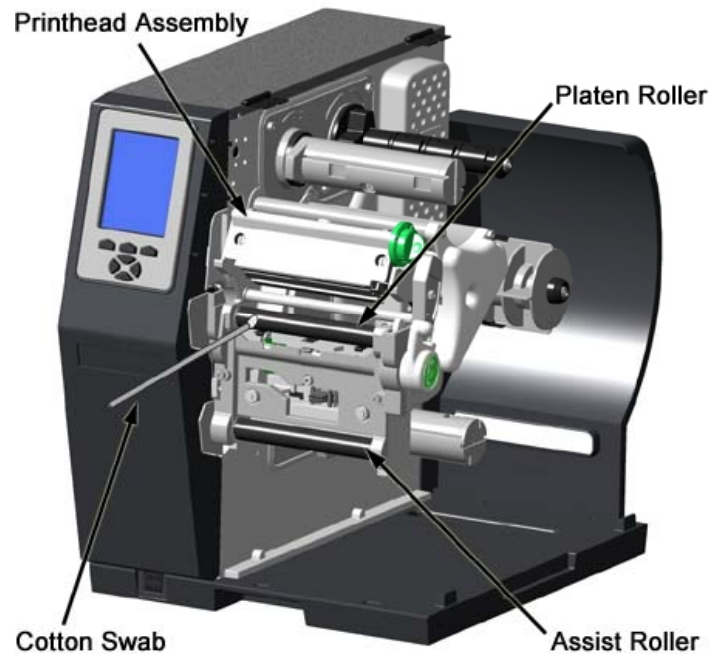

- A. Turn OFF the Power Switch and unplug the power cord from the AC Receptacle.
- B. Raise the Cover then remove the Door and tearbar. Unlock the Printhead Latch and raise the Printhead Assembly.
- C. Remove media and ribbon.
- D. Using a Cotton Swab (or lint-free cloth) dampened with isopropyl alcohol, wipe the Platen and the Assist Roller clean. Manually rotate the rollers as necessary, wiping, rotating, and repeating until the surfaces of each are clean.

5.5.6 *Cleaning the Ribbon Path Components* (Thermal Transfer equipped)

Smooth ribbon flow can become impeded if the components are dirty. Clean them as follows:

- A. Turn OFF the Power Switch and unplug the power cord from the AC Receptacle. Raise the Cover then remove media and ribbon.
- B. Using a Cotton Swab dampened with alcohol, wipe the Ribbon Idlers clean.

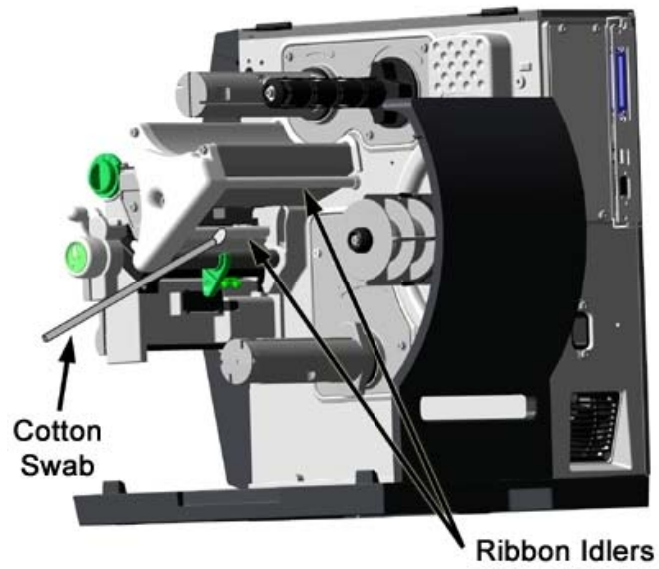

C. Using a Cotton Swab dampened with alcohol, wipe the Ribbon Shield clean.



D. Reload media and ribbon then close the Cover.

5.5.7 Cleaning the Exterior Surfaces

When soiled, the exterior surfaces of the printer should be cleaned using a general-purpose cleanser. Never use abrasive cleansers or solvents, and never pour a cleanser directly onto the printer.

- A. Turn OFF the Power Switch and unplug the power cord from the AC Receptacle.
- B. Using a soft cloth (or sponge) dampened with a non-abrasive cleanser, wipe the exterior surfaces clean.
- C. Allow the surfaces to dry before reconnecting power.

5.6 Updating the Firmware

The printer's operating application (firmware) can be updated as follows:



Depending upon the firmware version, stored data on Modules G & X can be lost when performing an update.

- A. Identify the desired version of firmware for the printer from our web site at <http://www.datamax-oneil.com> and then download that file onto your computer's hard drive.



If updating to version 11.021 or greater, the Boot Loader must be updated before proceeding; see Section 5.7. And, disconnect any USB keyboard from the USB port.

- B. Turn OFF the printer. Connect your computer to the printer via the parallel or USB port, and then turn ON the printer.
- C. Using the Windows print driver, open the Printer Properties box and select the "Tools" tab. Then, from the "Action" drop-down box, select "Send File to Printer."
- D. When prompted, browse to the file downloaded onto your computer's hard drive and send it to the printer.

Following a successful download, the printer will reset. Unless substantial data structure changes have occurred as a result of the firmware upgrade, the previous printer setup will remain intact; otherwise, you may need to calibrate the printer and enter any custom settings. To verify the new firmware version and current database configuration, print a Configuration Label (see Section 4.3.5).



If the download was unsuccessful, the printer will perform a "warm reset" and the original firmware will remain operational. (If the reset fails to occur, cycle the Power Switch OFF and ON.) A list of error messages and possible solutions is given below.

Use the following list of solutions if errors occur when attempting an update:

Firmware Updating Error Messages	
Displayed Message	Descriptions / Possible Causes / Solutions
DECOMPRESSION ERROR	An error occurred during the decompression and transfer of file data from cache storage into the Flash memory. Confirm the firmware version and try the download again; however, if the problem continues call for service.
ERROR ERASING FLASH	Flash memory could not successfully be erased. Defective Flash memory is a possible cause. Try the download again; however, if the problem continues call for service.
ERROR WRITING FLASH	The program could not successfully be written into Flash memory. Defective Flash memory is a possible cause. Try the download again; however, if the problem continues call for service.
HARDWARE MISMATCH	The firmware downloaded is not compatible with the Main Logic Card, is for a different model printer, or is not supported by the Boot Loader version. See Configuration Level.
INVALID SOFTWARE	A error was detected during download, possible causes and solutions include: <ul style="list-style-type: none"> • An invalid or corrupted file was downloading. Try resaving the file to the host. Download the file to the printer. • A communications error occurred. Recheck the cabling and port settings.
SOFTWARE MISMATCH	The software level being installed is not authorized for this printer. See the Printer Key information; Section 4.2.4.

5.7 Updating the Boot Loader

Boot Loader updates can be found at <ftp://ftp.datamax-oneil.com>. Before proceeding, identify the printer's current Boot Loader version by printing a Configuration Label (see Section 4.3.5). Compare the current version to those available from the FTP site. Download the desired version onto your computer's hard drive then follow the steps below to install the program.



If power is lost while UPGRADING SOFTWARE is displayed, the printer will become non-functional and will require factory programming or a main logic card.

Boot Loader Update Procedure			
Step	Displayed Message	Action	Comment(s)
A	READY	Using the DOS copy command (where "filename" is the program to be loaded and "lpt1" is the selected interface port), enter the following: <code>copy filename lpt1:</code>	As an example, this would be entered as: <code>copy BOOTHE99_1101.bs lpt1</code> (Where lpt1 can differ to include other ports, as available.) The Ready Indicator will flash as data is received.
B	UPGRADING SOFTWARE	No action required.	The new program is being stored and verified.
C	H4212.173 07/04/2006		The printer has reset.
D	READY		The new application is now running.  If UNCALIBRATED is displayed, see Section 3.4.



If the update failed, press and hold PAUSE and TEST while turning ON the printer (see Section 4.1) then release the buttons after SEND SOFTWARE is displayed and send the file as described above.

5.8 Fonts

Downloading Kanji, Hangul and Chinese Fonts

Fonts (KANJI, HANGUL and CHINESE) can be downloaded and stored in a printer module. Font files are identified by part number and are protected by lock bits, which unlocked by entering the correct 6-digit code via the control panel.

The printer can be easily and quickly updated:

- A. Identify the desired version of firmware for the printer from our web site at <http://www.datamax-oneil.com> and then download that file onto your computer's hard drive.

- B. Call to get the unlock code and enter it into the printer. Turn OFF the printer.
- C. Turn OFF the printer. Connect your computer to the printer via the parallel or USB port, and then turn ON the printer.
- D. Using the Windows print driver, open the Printer Properties box and select the "Tools" tab. Then, from the "Action" drop-down box, select "Send File to Printer."
- E. When prompted, browse to the downloaded font file on your computer's hard drive and then send that file to the printer.



If protected, the destination module must first be unprotected.

With a successful download and installation, the printer will reset. Installed fonts can be identified by part number and appear on the Configuration Label (and System Display). The following table lists possible font downloading messages:

Font Download Messages	
Displayed Message	Descriptions / Possible Causes / Solutions
ACCESS DENIED FILE EXISTS	A font file of the same name already exists in memory.
ACCESS DENIED SOFTWARE MISMATCH	The printer has an insufficient configuration level for an encrypted plug-in, an unlocked font bit, or key mismatch. Verify the Configuration Level of the printer by examining the Printer Key then compare it to the software level requirement for the file being installed.
INVALID HEADER	A wrong file format, file header is corrupt or a transmission error has occurred. Confirm the font version and try the download again; however, if the problem continues call for service.
INVALID IMAGE	The download content was corrupted or a transmission error occurred. Check for corruption by printing a Configuration Label (see Section 4.3.5) or by looking at the system window; a double question mark before the plug-in part number indicates corruption. Try the download again; however, if the problem continues call for service.
SUCCESSFUL	The file was successfully installed; the printer will perform an automatic reset.

Font Download Messages <i>(continued)</i>	
Displayed Message	Descriptions / Possible Causes / Solutions
SYSTEM FAULT	Insufficient memory space for the file exists in the destination module. Try selecting a different destination module or clear some space on the module and perform the download again.
WRITING FLASH	The file was successfully decrypted, verified, and is now being written into the destination module.
WRITING FLASH FAILED	The file failed checksum verification after being written to the module. Try the download again; however, if the problem continues call for service.

Processing TrueType Fonts

To process TrueType fonts (.TTF) on an external module for use by the printer:

1. Use Windows Explorer to download the font to a module.
2. Install the module in the printer.
3. Press the **MENU** button then select **Printer Options**.
4. Select **Modules** and then **Process File**.
5. Select the module ID and the font file.
6. When prompted enter a 2 character font ID, and then the destination module ID.
7. Ensure that your label formats use the same font ID as assigned in Step 5.

Copying TrueType Fonts

To copy TrueType fonts (.TTF) to an external module for use by the printer:

1. Use Windows Explorer to download the font to the module.
2. Add a 2 digit DPL font ID to the file name (50-99, 9A-9Z, 9a-9z) then change the file extension to .dtf (for example, *arial50.dtf*); see *Scalable Font Downloading in the Class Series 2 Programmer's Manual*.
3. Install the module in the printer.
4. Ensure that your label formats use the same font ID as assigned in Step 2.

Removing Fonts

When deleting a plug-in, all files contained within that directory will be deleted as well; see **MODULES / DELETE FILE**, Section 4.2.3.

5.9 Replacing the Printhead

If the printhead needs to be replaced, follow the procedure below:



- Only use a Datamax-O'Neil IntelliSEAQ™ printhead.
- Printheads are fragile; handle with extreme care and never use sharp objects on the surface.
- If you have questions, contact a qualified technician or Datamax-O'Neil Technical Support before proceeding.

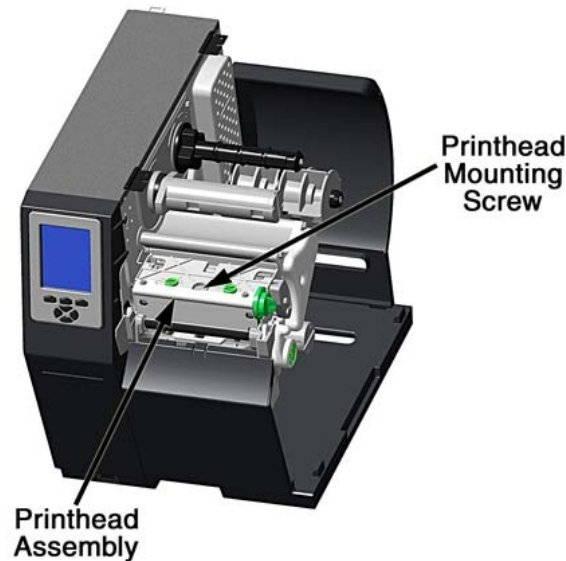

- A. Turn OFF the Power Switch then touch a bare metal printer surface (e.g., the frame) to discharge any static electricity present on your body.
- B. Unplug the printer and open the access cover. If ribbon is installed, remove it.
- C. Lower the Printhead Assembly and loosen the Printhead Mounting Screw. (If using an H-8308X model, loosen both mounting screws.)
- D. Carefully raise the Printhead Assembly. Grasp the printhead then disconnect the two cables and remove the printhead.
- E. Position a new printhead under the Printhead Assembly and connect the previously removed cables.
- F. After ensuring that the printhead cables are not pinched, place the printhead onto the locating pins under the Printhead Assembly and secure it by tightening the Printhead Mounting Screw(s). [Do not over-tighten the screw(s)].
- G. Using a Cotton Swab moistened (not soaked) with isopropyl alcohol, clean the printhead then allow it to dry.

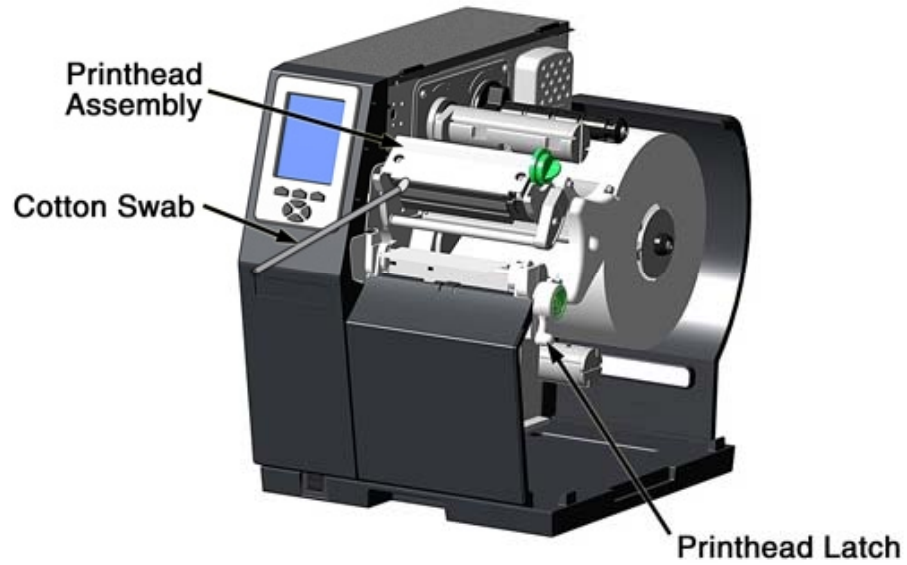

- H. If removed, reinstall ribbon. Lower and lock the Printhead Assembly. Plug in the printer and turn ON the Power Switch. Print a Validation Label (see Section 4.3.4) then compare the contrast levels between the current label and a previously printed label; if necessary, adjust the DARKNESS setting (see Section 4.2.2) until similar black levels are produced.

6 Troubleshooting

6.1 Problem Resolution

When a problem is encountered, the information in this section will help resolve it. Locate the description of the problem to find an appropriate solution. For problems that are accompanied by a displayed message, see Section 6.1.2.



Depending on your labeling program and the printer's menu settings, some commands and selections can be ignored. See HOST SETTINGS (Section 4.2.5) for more information and consult your software vendor for program information. If you have questions or if problems persist, contact a qualified technician or Datamax-O'Neil Technical Support.

6.1.1 General Resolutions

The following table lists problems that may not be accompanied by a displayed message:

If experiencing this problem...	Try this solution...
Blank display (but the backlight is ON):	Check the following possibilities: <ul style="list-style-type: none">• The display contrast may set too low (press and hold the MENU Button until the contrast is acceptable); or,• Disconnect any device attached to the optional SDIO Slot or USB Host Port.
Erratic feeding:	The printer may require calibration (see Section 3.4).
Erratic printing:	Check the following possibilities: <ul style="list-style-type: none">• If in Hex Dump Mode, disable it (see Section 6.2); or,• If using serial communications, check the host and printer port settings; the printer may be set to eight data bits while the host is set to 7, or vice versa (see Section 4.2.5).

General Resolutions (continued)

If experiencing this problem...	Try this solution...
External memory device is not recognized:	<p>With the memory device properly installed (see Section 2.2.3) in the printer, observe the display and proceed accordingly:</p> <ul style="list-style-type: none"> • If the appropriate Current State Icon (see Section 4.1.1) is present, ensure that the module has been formatted. • If the Current State Icon is not present, ensure that the device is a recognizable type.
Intellifont will not print:	<p>You may be using an incorrect type – Intellifont format is Little/Big Endian specific and the printer uses Big Endian; refer to your font supplier for information.</p>
Light print on the side of the label:	<p>Check the following possibilities:</p> <ul style="list-style-type: none"> • The Leveling Cam may be incorrectly adjusted (see Section 5.4.1); or, • The Platen may be dirty or worn (see Section 5.5.5).
Missing label information:	<p>Check the following possibilities:</p> <ul style="list-style-type: none"> • Check the label format for character or image placement outside the label dimensions. All row / column values must allow space for the characters and bar codes to be printed within the format size; • Available memory may have been exceeded by the format requirements. Try reducing the memory allocation to either INTERNAL MODULE or SCALEABLE FONT (see Section 4.2.4); or, • If using serial communications, ensure that the interface cable meets the printer’s requirements (see Section 2.2.2).

General Resolutions (continued)

If experiencing this problem...	Try this solution...
No power:	<p>Check the following possibilities:</p> <ul style="list-style-type: none"> • Verify that the AC power cord is connected to the outlet and to the printer, and that the Power Switch is ON; • Verify that the AC outlet is functioning, or move the printer to another location on a different circuit; • Replace a possibly damaged AC cord; • The line fuse may be blown (call for service); or, • If using a tall model, possible disconnected or defective fan; call for service.
No print using direct thermal media (labels advance normally):	<p>Test the labels to be sure they react to heat then proceed accordingly:</p> <ul style="list-style-type: none"> • If reactive, increase the HEAT setting in the software program or via the menu (see Section 4.2.2); or, • If not reactive, install direct thermal media.
No print using thermal transfer media (labels advance normally):	<p>Examine the used ribbon for an image, then proceed accordingly:</p> <ul style="list-style-type: none"> • If an image is on the used ribbon, verify that the ribbon was properly loaded. (To identify the coated side, press the sticky side of a label against the ribbon surfaces -- ink will lift from the coated side.) Clean the printhead (see Section 5.5.1) and reinstall the ribbon (see Section 3.3); or, • If no image is on the used ribbon, try the following: Run a Test label, and if an image printed then ensure that the protocol and port settings for the printer and host match; see Section 4.2.5. Increase the HEAT setting; see Section 4.2.2. Verify that the media and ribbon combination is compatible; see Section 7.3.

General Resolutions (continued)

If experiencing this problem...	Try this solution...
<p>No print when using a software program (Test labels print normally):</p>	<p>Ensure that the printer is at READY then observe the display when sending your label format to the printer and proceed accordingly:</p> <ul style="list-style-type: none"> • If Receiving Data (see Section 4.1.1) is not indicated, check the protocol, port settings and / or IP Address between the printer and host. If networking, check for the appropriate Current State Icon. Also, ensure that the interface cable meets the requirements of the printer and host, and that it is properly connected; or, • If Receiving Data is indicated, enter COMMUNICATIONS / ESC SEQUENCES and disable the setting (see Section 4.2.5).
<p>Poor print quality:</p>	<p>Check the following possibilities:</p> <ul style="list-style-type: none"> • Adjust the Leveling Cam (see Section 5.4.1); • Adjust the Heat and Print Speed settings (see Section 4.2.2); • If using thermal transfer, ensure media and ribbon compatibility (see Section 7.3); and, • Clean the printhead (see Section 5.5.1).
<p>Skips labels when printing:</p>	<p>Check the following possibilities:</p> <ul style="list-style-type: none"> • Perform calibration; (see Section 3.4); • Adjust the Media Sensor (see Section 3.2); and, • If the label format is within 1/8 inch of the media's edge, reduce or move the format slightly.

6.1.2 Warning and Fault Messages

The printer displays messages when the possibility of a problem or an actual fault occurs. Depending upon the displayed message, find the possible action or solution in the tables below.



Warning and Fault Messages do not appear when in Menu or Test Mode.

Warning Messages

Displayed for about three seconds, Warning Messages assume a low priority and indicate a pending change in printer configuration, or an operating condition that could lead to a fault.

Warning Messages		
Displayed Message	Description	Possible Solution(s)
24V OUT OF TOLERANCE	The printer has detected a drop in the 24-volt power supply.	No action is required. If the problem continues, cycle the power OFF and ON.
DOT FAILURE	Defective printhead elements have been detected.	Replace the printhead if print quality becomes unacceptable.
GAP MODE WARNING LOW BACKING	Only a small difference exists between the measured Empty and Gap readings.	No action is required. During calibration, labels mounted on a transparent liner or notched media may give this indication. A slight delay in the OUT OF STOCK message may occur.
GOODBYE	Power has been removed and printer shutdown is in progress.	AC line voltage has been lost. The Power Switch was turned OFF or the line fuse has blown. If unable to restore power, try moving the printer to another location and if the condition persists, call for service.

Warning Messages Fault Messages <i>(continued)</i>		
Displayed Message	Description	Possible Solution(s)
HEAD NEEDS CLEANING	The scheduled printhead cleaning distance has been reached.	Clean the printhead (see Section 5.5.1). To change the cleaning setting, enter ADVANCED MENU / MEDIA SETTINGS / PRINTHEAD CLEANING MENU.
HOST CHANGES PENDING	The host has changed the configuration of the printer, but those changes cannot take effect until a "host reset command" is issued.	To save these changes, send a host reset command (in DPL); or, to discard the changes, perform a soft reset (see Section 5.3.1).
INVALID ENTRY	The selection you are attempting to make is not valid or is not within the acceptable parameter range.	Enter a different setting or parameter that falls within the acceptable range.
LOW VOLTAGE	The printer has detected a low operating voltage.	Possible low or fluctuating line voltage levels have been sensed. If the condition persists, try moving the printer to another outlet, or call for service.
REWINDER FULL	The internal rewinder is nearing capacity.	Unload the internal rewinder soon.
RIBBON LOW	The ribbon supply is almost empty.	Load a new roll of ribbon soon.
RTC RAM FAILURE	The printer was unable to save settings in permanent memory.	Possible faulty Main Logic Card. Retry your save. If the condition persists, call for service.
TEMPERATURE PAUSE	A high printhead temperature has been detected.	Wait for the printhead to cool. Afterward, printer operations will automatically resume when the printhead reaches an acceptable temperature.

Fault Messages

These high priority messages alert you to a printer fault condition. (Alternate messages may occur when downloading font, firmware, or Boot Loader files.)



To return operation after a fault occurs, the fault must be corrected and the FEED Key pressed.

Fault Messages		
Displayed Message	Description	Possible Solution(s)
ADC FAULT	The printer has detected an analog to digital circuit converter failure.	Cycle printer power OFF and ON. If the fault does not clear, call for service.
CLOSE HEAD LATCH	The Printhead is not latched.	Lock the Printhead Latch (see Section 3.1).
DMA FAULT	The printer has detected a Direct Memory Access failure.	Cycle printer power OFF and ON. If the fault does not clear, call for service.
GAP MODE CANNOT CALIBRATE	Consistently low sensor readings have been detected for the media.	Press any key to continue. Ensure that media was removed from the media sensor during the appropriate calibration steps (see Section 5.2); also, ensure that ribbon has been correctly loaded and that the sensor is clean (see Section 5.5.4). Retry the calibration. If the problem persists, try Advanced Entry Calibration (see Section 5.2.2).
GAP MODE FAULTY SENSOR	Consistently high sensor readings have been detected for the media.	Press any key to continue. Ensure that media was removed from the media sensor during the appropriate calibration steps (see Section 5.2); also, ensure that ribbon has been correctly loaded and that the sensor is clean (see Section 5.5.4). Retry the calibration. If the problem persists, call for service.

Fault Messages <i>(continued)</i>		
Displayed Message	Description	Possible Solution(s)
HEAD CLEANING FAULT	The scheduled printhead cleaning has been exceeded by an amount equal to three times the pre-programmed distance.	Clean the printhead (see Section 5.5.1). To change the cleaning setting, enter ADVANCED MENU / MEDIA SETTINGS / PRINTHEAD CLEANING MENU.
OUT OF STOCK	The printer cannot detect the presence of media.	Examine the printer for media then proceed accordingly: <ul style="list-style-type: none"> • If the printer is out of stock, load media; or, • If stock is loaded, ensure that the Media Sensor is calibrated (see Section 3.4), properly positioned (see Section 3.2) and, if the media has large gaps, that the Paper Empty Distance is adjusted (see Section 4.2.1).
POSITION FAULT	Possible causes of this fault include a firmware update, a power failure or reset during a ribbon, out of stock or TOF fault, and an incomplete calibration process.	Press the FEED Key in an attempt to identify and then clear the fault. Perform calibration (see Section 3.4).
PRINT ENGINE FAULT	A problem within the print logic has been detected.	Cycle printer power OFF and ON. If the fault does not clear, call for service.
RAM FAULT	A memory failure has been detected.	Cycle printer power OFF and ON. If the fault does not clear, call for service.

Fault Messages <i>(continued)</i>		
Displayed Message	Description	Possible Solution(s)
REFLECTIVE MODE CANNOT CALIBRATE	Consistently low sensor readings were detected.	Press any key to continue. Ensure that the reflective mark was inserted face down. Also, ensure that the sensor is clean and that the reflective mark is made from carbon-based ink. Retry calibration (see Section 5.2).
REFLECTIVE MODE FAULTY SENSOR	Consistently high sensor readings were detected.	Press any key to continue. Ensure that media was removed from the media sensor during the appropriate calibration steps; also ensure that no labels are stuck in the media sensor. Retry calibration (see Section 5.2). If the problem persists, call for service.
REWINDER FAULT	No rewinder movement is detected.	Examine the rewinder then proceed accordingly: <ul style="list-style-type: none"> • If full, unload the internal rewinder then press the FEED Key to clear the fault; or, • If not full, cycle printer power OFF and ON. If the fault does not clear, call for service. <hr/> <p> <i>To continue printing, enter the menu then go to PRINTER OPTIONS / REWINDER and disable the option (see Section 4.2.3).</i></p>
REWINDER FULL	The internal rewinder is at capacity and has stopped turning.	Unload the internal rewinder then press the FEED Key to clear the fault.

Fault Messages <i>(continued)</i>		
Displayed Message	Description	Possible Solution(s)
RIBBON FAULT	<p>Two causes are possible:</p> <p>(1) The Thermal Transfer media type has been selected, but no ribbon movement or only sporadic movement has been detected.</p> <p>(2) The ribbon sensor values have changed.</p>	<p>If using direct thermal stock, change the Media Type setting to Direct Thermal; otherwise ensure that ribbon is installed.</p> <p>Press the FEED Key to clear the fault -- if the fault does not clear check the Ribbon Hubs for free movement. Also, ensure that the ribbon core fits snugly onto the supply hub, and that the ribbon is not slipping or stalling as labels print. If no binding, slipping, or stalling is apparent press and hold the FEED Key until at least three labels have been output. If the fault does not clear, call for service.</p>
TEMPERATURE FAULT	<p>The printer has shutdown due to the printhead temperature.</p>	<p>Turn OFF the printer. Ensure that the printer has been installed within an acceptable environment. DO NOT restart until the printhead cools.</p>

Fault Messages <i>(continued)</i>		
Displayed Message	Description	Possible Solution(s)
TOP OF FORM FAULT	<p>The printer could not find a TOF mark within the maximum length setting, or TOF was encountered in an unexpected place.</p> <hr/> <p><input checked="" type="checkbox"/> <i>When the SENSOR TYPE is REFLECTIVE, this indication is given for Out Of Stock.</i></p> <hr/>	<p>Check the following possibilities:</p> <ul style="list-style-type: none"> • Calibration may be necessary (see Section 3.4); • The Media Sensor may need adjustment (see Section 3.2); • The Media Guide may need adjustment (see Section 3.1); • The Leveling Cam may need adjustment (see Section 5.4.1); • The MAXIMUM LABEL LENGTH may need to be increased (see Section 4.2.1); or • The Media Sensor may need to be cleaned (see Section 5.5.4).

6.2 Hex Dump Mode

Hex Dump Mode is a useful tool for diagnosing problems and debugging label formats as received host data strings are printed without interpretation by the printer. These strings can be analyzed for content and, by repeatedly sending a format, handshaking problems (sections of missing data) can become apparent.

- To enter Hex Dump Mode, press the MENU Button and select DIAGNOSTICS. Go to HEX DUMP MODE then select ENABLE and press the ENTER Key. Exit the menu, saving your changes.

Afterward, HEX DUMP MODE will be displayed and all received data will be output in hexadecimal code (along with the ASCII equivalents), printed or saved to a file (see FILE CAPTURE, Section 4.2.6). The example below illustrates a Hex Dump label output:

```

0000 02 4C 0D 44 31 31 0D 31 ^L_011.1
0008 36 31 31 30 30 30 30 33 61100003
0010 32 30 30 30 31 30 46 4F 200010FO
0018 4F 54 20 36 3A 20 41 4C NT 6: AL
0020 4C 20 56 41 4C 49 44 20 L VALID
0028 20 20 20 20 20 20 20 20
0030 20 20 20 0D 31 36 31 31 1611
0038 30 30 30 30 32 38 30 30 00002800
0040 30 31 30 20 20 20 20 20 010
0048 20 20 20 43 48 41 52 41 CHARA
0050 43 54 45 52 53 3A 0D 31 CTERS:.1
0058 36 31 31 30 30 30 30 32 61100002
0060 34 30 30 30 31 30 23 24 400010#$
0068 25 26 28 29 2A 2B 2E 2D %&()*+.-

```

To decode data strings the *Class Series 2 Programmer's Manual* is an essential reference (see the Accessories CD-ROM). Also, some software programs use bit mapping, which can make diagnosis difficult – contact Datamax-O’Neil Technical Support with any questions.



To return Operating Mode, enter the DIAGNOSTICS and disable HEX DUMP MODE. Exit the menu and save the changes.

7 Specifications

7.1 General

This section identifies shared parameters and features of the printer models.

Embedded Bar Codes & Fonts

See the *Class Series 2 Programmer's Manual* for details.

Communications

Interface Types:	USB; RS-232, RS-422/485 (DB-9); IEEE 1284 Compliant Parallel (Centronics); and, Ethernet
Serial Data Rates (RS-232):	1200 to 115,000 bits per second
Handshaking:	Xon/Xoff; CTS/DTR
Parity:	Even, Odd, or None
Stop Bits:	1 or 2
Data Bits:	7 or 8

Electrical

AC Input Voltage Range:	90 - 132 VAC, and 180 - 264 VAC @ 47 - 63 Hz
Power Consumption:	Typical operating: 150 Watts; Standby: 21 Watts
Power Supply:	Auto ranging switching type.
Printhead Protection:	Thermistor protected to temporarily halt printing upon high temperature detection then resume after cool-down.

Environmental

Operating Temperature Range:	32° to 100° F (0° to 38° C)
Storage Temperature:	0° F – 140° F (-17° C to 60° C)
Humidity Range:	10% – 95% non-condensing
Dust:	Non-conducting, non-corrosive
Electromagnetic Radiation:	Moderate RF fields can be tolerated.

7.2 Model-Specific Specifications

This section identifies unique parameters and features of the printer models, where X denotes the tall version of the model.

H-4212, H-4310, H-4408, & H-4606 Models

Mechanical

Height:	13 inches (329.7 mm)
Width:	12.6 inches (321.1 mm)
Depth:	18.9 inches (480.1 mm)
Weight:	40 pounds (18.1 kg)

Electrical

Display:	Graphics (128 X 64 pixels) with backlight; or (Optional) Graphics (240 X 320 pixels) with backlight.
----------	---

Printing

Method:	Direct Thermal or (optional) Thermal Transfer
Speed:	2 - 12 IPS (51 - 305 MMPS); <i>H-4212</i> 2 - 10 IPS (51 - 254 MMPS); <i>H-4310</i> 2 - 8 IPS (51 - 203 MMPS); <i>H-4408</i> 2 - 6 IPS (51 - 152 MMPS); <i>H-4606</i>

Printing *(continued)*

Resolution:	203 DPI (8 dots/mm); <i>H-4212</i> 300 DPI (12 dots/mm); <i>H-4310</i> 406 DPI (16 dots/mm); <i>H-4408</i> 600 DPI (23.6 dots/mm); <i>H-4606</i>
Dot Size (nominal):	.0043" X .0052" (.11 mm x .13 mm); <i>H-4212</i> .0027" X .0043" (.07 mm x .11 mm); <i>H-4310</i> .0013" X .0018" (.03 mm x .05 mm); <i>H-4408</i> .0008" X .0015" (.02 mm x .04 mm); <i>H-4606</i>
Tear Bar:	Downward tear

Media

Types:	Die-Cut, Notched, Continuous, and Reflective (Roll or Fanfold)
Internal Capacity:	8-inch (203mm) Outer Diameter Roll (on a standard 3-inch core; or, on a 40 mm core with the optional supply hub)
Ribbon Width Range:	1 inch - 4.65 inches (25 mm - 118 mm)
Ribbon Length:	1968 feet (600 m)
Dimensions:	Reference the drawing and table below:

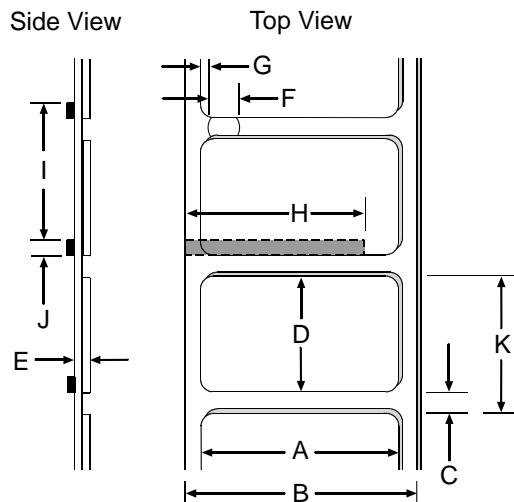

Media (continued)

H-4212, H-4310, H-4408, & H-4606 Media Dimensional Requirements ^[1]					
Designator	Description	Minimum		Maximum	
		inches	mm	inches	mm
A	Label width	1.00	25	4.65	118
B	Liner width	1.00	25	4.65	118
C	Gap (or notch) between labels ^[3]	.08	2	-	-
D	Label length ^[3]	.25	6	-	-
E	Media thickness	.0025	.06	.01	.25
F	Notch opening width	.08	2	-	-
G	Media edge to sensor aperture	.20	5	2.25	70
H	Reflective mark width ^[2]	.47	12	4.65	118
I	Distance between reflective marks ^[3]	.25	6	-	-
J	Reflective mark length ^[3]	.08	2	-	-
K	Label repeat distance ^[3]	.33	8	-	-

^[1] Units of measure are referenced by the direction of label feed.

^[2] The reflective (black) mark must be carbon based, placed on the backside of the stock, and the reflectance shall be less than 10% at wavelengths of 950 and 640 nm.

^[3] The maximum allowable length of the combined label and gap (or mark) measurement cannot exceed 99.99 inches.

H-4212X, H-4310X, & H-4606X Models

Mechanical

Height: 16.4 inches (415.3 mm)

Width: 12.6 inches (321.1 mm)

Depth: 19.3 inches (489 mm)

Weight: 47 pounds (21.3 kg)

Electrical

Display: Graphics (240 X 320 pixels) with backlight.

Printing

Method:	Direct Thermal or (optional) Thermal Transfer
Speed:	2 - 12 IPS (51 - 305 MMPS); <i>H-4212X</i> 2 - 10 IPS (51 - 254 MMPS); <i>H-4310X</i> 2 - 6 IPS (51 - 152 MMPS); <i>H-4606X</i>
Resolution:	203 DPI (8 dots/mm); <i>H-4212X</i> 300 DPI (12 dots/mm); <i>H-4310X</i> 600 DPI (23.6 dots/mm); <i>H-4606X</i>
Dot Size (nominal):	.0043" X .0052" (.11 mm x .13 mm); <i>H-4212X</i> .0027" X .0043" (.07 mm x .11 mm); <i>H-4310X</i> .0008" X .0015" (.02 mm x .04 mm); <i>H-4606X</i>
Tear Bar:	Downward tear

Media

Types:	Die-Cut, Notched, Continuous, and Reflective (Roll or Fanfold)
Internal Capacity:	8-inch (203mm) Outer Diameter Roll (on a standard 3-inch core; or, on a 40 mm core with the optional supply hub)
Ribbon Width Range:	1 inch - 4.65 inches (25 mm - 118 mm)
Ribbon Length:	1968 feet (600 m)
Dimensions:	Reference the drawing and table below:

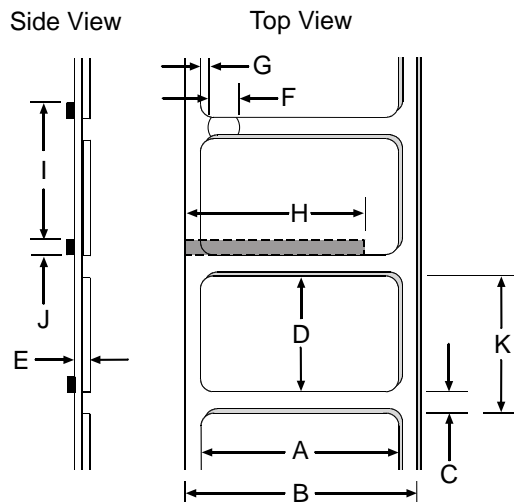

Media (continued)

H-4212X, H-4310X, & H-4606X Media Dimensional Requirements ^[1]					
Designator	Description	Minimum		Maximum	
		inches	mm	inches	mm
A	Label width	1.00	25	4.65	118
B	Liner width	1.00	25	4.65	118
C	Gap (or notch) between labels ^[3]	.08	2	-	-
D	Label length ^[3]	.25	6	-	-
E	Media thickness	.0025	.06	.01	.25
F	Notch opening width	.08	2	-	-
G	Media edge to sensor aperture	.20	5	2.25	70
H	Reflective mark width ^[2]	.47	12	4.65	118
I	Distance between reflective marks ^[3]	.25	6	-	-
J	Reflective mark length ^[3]	.08	2	-	-
K	Label repeat distance ^[3]	.33	8	-	-

^[1]Units of measure are referenced by the direction of label feed.

^[2]The reflective (black) mark must be carbon based, placed on the backside of the stock, and the reflectance shall be less than 10% at wavelengths of 950 and 640 nm.

^[3]The maximum allowable length of the combined label and gap (or mark) measurement cannot exceed 99.99 inches.

H-6210 & H-6308 Models

Mechanical

- Height: 13 inches (329.7 mm)
- Width: 15 inches (381 mm)
- Depth: 18.9 inches (480.1 mm)
- Weight: 47 pounds (21.3 kg)

Electrical

- Display: Graphics (128 X 64 pixels) with backlight; or
(Optional) Graphics (240 X 320 pixels) with backlight.

Printing

Method:	Direct Thermal or (optional) Thermal Transfer
Speed:	2 - 10 IPS (51 - 254 MMPS); <i>H-6210</i> 2 - 8 IPS (51 - 203 MMPS); <i>H-6308</i>
Resolution:	203 DPI (8 dots/mm); <i>H-6210</i> 300 DPI (12 dots/mm); <i>H-6308</i>
Dot Size (nominal):	.0043" X .0052" (.11 mm x .13 mm); <i>H-6210</i> .0027" X .0043" (.07 mm x .11 mm); <i>H-6308</i>
Tear Bar:	Downward tear

Media

Types:	Die-Cut, Notched, Continuous, and Reflective (Roll or Fanfold)
Internal Capacity:	8-inch (203mm) Outer Diameter Roll (on a standard 3-inch core; or, on a 40 mm core with the optional supply hub)
Ribbon Width Range:	2 inches - 6.7 inches (51 mm - 170 mm)
Ribbon Length:	1968 feet (600 m)
Dimensions:	Reference the drawing and table below:

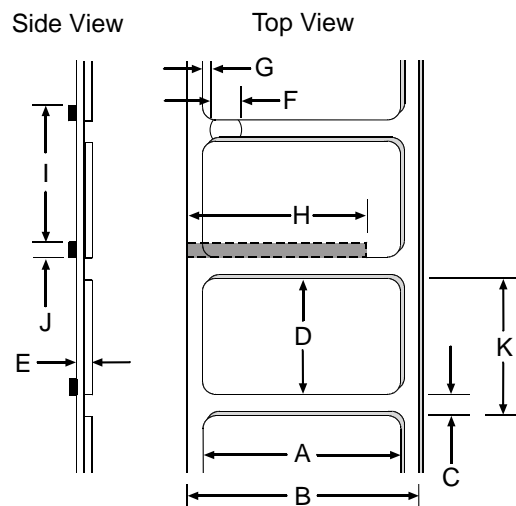

Media (continued)

H-6210 & H-6308 Media Dimensional Requirements ^[1]					
Designator	Description	Minimum		Maximum	
		inches	mm	inches	mm
A	Label width	2.00	51	6.7	170
B	Liner width	2.00	51	6.7	170
C	Gap (or notch) between labels ^[3]	.08	2	-	-
D	Label length ^[3]	.25	6	-	-
E	Media thickness	.0025	.06	.01	.25
F	Notch opening width	.08	2	-	-
G	Media edge to sensor aperture	.20	5	2.25	70
H	Reflective mark width ^[2]	.47	12	6.7	170
I	Distance between reflective marks ^[3]	.25	6	-	-
J	Reflective mark length ^[3]	.08	2	-	-
K	Label repeat distance ^[3]	.33	8	-	-

^[1]Units of measure are referenced by the direction of label feed.

^[2]The reflective (black) mark must be carbon based, placed on the backside of the stock, and the reflectance shall be less than 10% at wavelengths of 950 and 640 nm.

^[3]The maximum allowable length of the combined label and gap (or mark) measurement cannot exceed 99.99 inches.

H-6212X & H-6310X Models

Mechanical

Height: 16.4 inches (415.3 mm)

Width: 15 inches (381 mm)

Depth: 19.3 inches (489 mm)

Weight: 53 pounds (24 kg)

Electrical

Display: Graphics (240 X 320 pixels) with backlight.

Printing

Method:	Direct Thermal or (optional) Thermal Transfer
Speed:	2 - 12 IPS (51 - 305 MMPS); <i>H-6212X</i> 2 - 10 IPS (51 - 254 MMPS); <i>H-6310X</i>
Resolution:	203 DPI (8 dots/mm); <i>H-6212X</i> 300 DPI (12 dots/mm); <i>H-6310X</i>
Dot Size (nominal):	.0043" X .0052" (.11 mm x .13 mm); <i>H-6212X</i> .0027" X .0043" (.07 mm x .11 mm); <i>H-6310X</i>
Tear Bar:	Downward tear

Media

Types:	Die-Cut, Notched, Continuous, and Reflective (Roll or Fanfold)
Internal Capacity:	8-inch (203 mm) Outer Diameter Roll (on a standard 3-inch core; or, on a 40 mm core with the optional supply hub)
Ribbon Width Range:	2 inches - 6.7 inches (51 mm - 170 mm)
Ribbon Length:	1968 feet (600 m)
Dimensions:	Reference the drawing and table below:

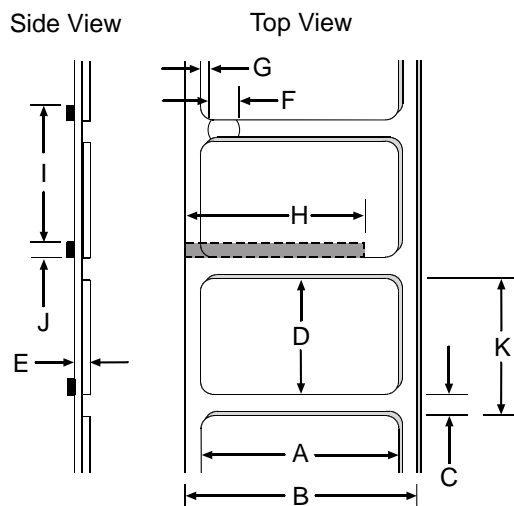

Media (continued)

H-6212X & H-6310X Media Dimensional Requirements ^[1]					
Designator	Description	Minimum		Maximum	
		inches	mm	inches	mm
A	Label width	2.00	51	6.7	170
B	Liner width	2.00	51	6.7	170
C	Gap (or notch) between labels ^[3]	.08	2	-	-
D	Label length ^[3]	.25	6	-	-
E	Media thickness	.0025	.06	.01	.25
F	Notch opening width	.08	2	-	-
G	Media edge to sensor aperture	.20	5	2.25	70
H	Reflective mark width ^[2]	.47	12	6.7	170
I	Distance between reflective marks ^[3]	.25	6	-	-
J	Reflective mark length ^[3]	.08	2	-	-
K	Label repeat distance ^[3]	.33	8	-	-

^[1] Units of measure are referenced by the direction of label feed.

^[2] The reflective (black) mark must be carbon based, placed on the backside of the stock, and the reflectance shall be less than 10% at wavelengths of 950 and 640 nm.

^[3] The maximum allowable length of the combined label and gap (or mark) measurement cannot exceed 99.99 inches.

H-8308X Model

Mechanical

Height: 16.4 inches (415.3 mm)

Width: 17 inches (432.8 mm)

Depth: 19.3 inches (489 mm)

Weight: 59 pounds (26.8 kg)

Electrical

Display: Graphics (240 X 320 pixels) with backlight.

Printing

Method:	Direct Thermal or (optional) Thermal Transfer
Speed:	2 - 8 IPS (51 - 203 MMPS)
Resolution:	300 DPI (12 dots/mm)
Dot Size (nominal):	.0027" X .0039" (.07 mm X .10 mm)
Tear Bar:	Downward tear

Media

Types:	Die-Cut, Notched, Continuous, and Reflective (Roll or Fanfold)
Internal Capacity:	8-inch (203 mm) Outer Diameter Roll (on a standard 3-inch core; or, on a 40 mm core with the optional supply hub)
Ribbon Width Range:	3 inches - 9 inches (76 mm - 228 mm)
Ribbon Length:	1968 feet (600 m)
Dimensions:	Reference the drawing and table below:

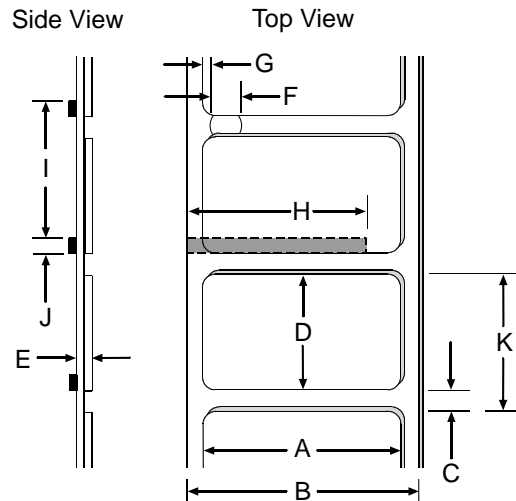

Media (continued)

H-8308X Media Dimensional Requirements ^[1]					
Designator	Description	Minimum		Maximum	
		inches	mm	inches	mm
A	Label width	3.00	76	9	228
B	Liner width	3.00	76	9	228
C	Gap (or notch) between labels ^[3]	.08	2	-	-
D	Label length ^[3]	.25	6	-	-
E	Media thickness	.0025	.06	.01	.25
F	Notch opening width	.08	2	-	-
G	Media edge to sensor aperture	.20	5	2.25	70
H	Reflective mark width ^[2]	.47	12	9	228
I	Distance between reflective marks ^[3]	.25	6	-	-
J	Reflective mark length ^[3]	.08	2	-	-
K	Label repeat distance ^[3]	.33	8	-	-

^[1]Units of measure are referenced by the direction of label feed.

^[2]The reflective (black) mark must be carbon based, placed on the backside of the stock, and the reflectance shall be less than 10% at wavelengths of 950 and 640 nm.

^[3]The maximum allowable length of the combined label and gap (or mark) measurement cannot exceed 99.99 inches.

7.3 Approved Media and Ribbon

Media (and ribbon for thermal transfer) is an important determinant in the throughput, quality, and performance of the printed product. The following overview is an introduction to the different types of material that can be used in the printer. For complete information and advice regarding a specific application, consult a qualified media specialist or a Datamax-O'Neil Media Representative. Also available is an informative white paper, *A Brief Introduction to Media*, which can be found at www.datamax-oneil.com

Direct Thermal

Consider three important factors when selecting direct thermal stock:

- The abrasive qualities of the material that covers the thermal reactive layer of the paper;
- The amount of heat required to start the chemical reaction; and,
- The ability of the media to control that chemical reaction.

Thermal Transfer

Consider three important factors when selecting thermal transfer media and ribbon combinations:

- Label top coating and ribbon combinations may affect image quality;
- Ribbon backcoating can provide printhead protection and, depending upon the formula, help reduce static buildup; and,
- The ribbon width, when slightly wider than the media, can also guard the printhead against media abrasion.

Media and Ribbon Selection

To achieve optimum print quality and maximum printhead life, we specify the use of DATAMAX-O'NEIL brand media. These supplies are specially formulated for use in our printers; use of non-Datamax-O'Neil supplies may affect the print quality, performance, and life of the printer or its components. For a current list of approved media, please contact a Media Representative at (407) 523-5650.

Suggested direct thermal and thermal transfer applications are listed below:

Media and Ribbon Overview				
Direct Thermal Media	Print Speed*	Print Energy	Image Durability	
Datamax-O'Neil DTL-HSM	10 - 12**	Medium	Low	
Datamax-O'Neil DTL-HSH	10 - 12**	Medium	Low	
Thermal Transfer Media	Ribbon Type	Print Speed*	Print Energy	Image Durability
Great Label TTL	GPR Plus	10 - 12**	Medium	Medium
Coated and uncoated paper, tag stock, some films and synthetics	Wax GPRPlus	2 - 10	Low	Low
Coated and glossy paper, tag stock, some films and synthetics	Wax/Resin PGR+	2 - 8	Medium	High
Synthetics and films	Resin SDR	4 - 6	High	High

* Given in inches per second.

** Highly recommended for optimum quality at speeds above 10 IPS.

Appendix A

Module Assignments, and File Handling Definitions and Messages

Module Assignments

Memory Module	
Designator	Definition / Location
D	DRAM (Main Logic Card)
F	SD Memory Card (Optional, for port-equipped models only)
G	FLASH (Main Logic Card)
H	USB Thumbdrive (Optional, for port-equipped models only)
I	USB Thumbdrive (Optional, for port-equipped models only)
X	FLASH (Main Logic Card)
Y	FLASH (Main Logic Card)

File Handling Definitions

The following file types are supported and, as noted, converted by the printer.

Process File Handling (see Section 4.2.3)	
File Type	Definition / Requirements
BMP, PCX, and IMG	Industry standard black and white graphics formats.
BS	Boot Loader upgrade file.
F7B	A 7-bit image load file.
LS	Language message file in a single or double byte format generated from an Excel spread sheet via macros.
PLG	A file group containing hidden, encrypted, or normal files.
SFL and SFP	Industry standard portrait and landscape bit-mapped font formats, where the label name should contain the Font ID as last three digits before the file extension to allow automated conversion (see DBM, below).
TTF	Industry standard true type / scalable font formats, where the label name should contain the Font ID as last two digits before the file extension to allow automated conversion (see DTT, below).
ZS and ZG	A compressed firmware upgrade file.

Print File Types (see Section 4.2.3)	
File Type	Definition / Requirements
DBM	A bit-mapped font file, created after download using "Font Loading Commands" (see the <i>Class Series 2 Programmer's Manual</i>) or PROCESS FILE (above) for use as label typeface.
DCM	A configuration file for custom printer setup, savable and restorable via the menu or DPL commands (see the <i>Class Series 2 Programmer's Manual</i> for details). This file cannot be copied from the Y Module.
DIM	A converted BMP, PCX, IMG, or F7B file for use in label formats.
DLB	A label format file, recallable and printable (see <STX>L in the <i>Class Series 2 Programmer's Manual</i> for details).
DLN	A language message file containing printer language translations.
DMS	A database or miscellaneous file for custom option or feature setup, automatically created by the printer (cannot be copied from the Y module).
DPL	A file containing control and / or label data as typically generated by printer driver software.
DTT	A true type or scalable font file created after download using the <STX>i command (see the <i>Class Series 2 Programmer's Manual</i>) or "Process File" (see PRINTER OPTIONS / MODULES, Section 4.2.3). This can be used for label or display fonts.
PLU	A converted PLG file. (Encrypted types cannot be copied.)

File Handling Messages

Depending upon the module and operation selected, several messages are possible when using the file handling system:

File Handling Messages		
Displayed Message	Description	Possible Solution(s)
FAILED	The copy or format request has failed.	Not enough space exists on the module to store the file or the module may be protected - try storing the data to a different location. (If the problem persists, this could indicate a hardware problem.)
FILE EXISTS, OVERWRITE?	An existing file of the same name and type was found.	Select YES to overwrite or NO to exit.

File Handling Messages <i>(continued)</i>		
Displayed Message	Description	Possible Solution(s)
MODULE PROTECTED	The request has been denied because the module is protected.	Unprotect the module.
NO FILES AVAILABLE	No associated files can be found to perform the requested action.	<p>Ensure the file is present:</p> <ul style="list-style-type: none"> • Following a Print File request, this is normal when no print files exist (also, some files will only print the file name); • Following a Process File request, this is normal when no files are available for processing (also, some files may not display); or, • Following a Copy File request, this is normal when no files are available for copying (also, internal database files cannot be copied).
NOT SUPPORTED	The file requested is not a supported type.	Recheck the file type requested, and ensure that it is available for that function; see File Handling Definitions, Appendix A.
PROTECTED, PROTECTED COPY FILE?	The file requested will be copied to a PROTECTED module.	Select YES to override protection and copy the file, or NO to exit.
UNFORMATTED	The module is not formatted.	<p>Format the module.</p> <hr/>  Choosing FORMAT MODULE will erase all module data.

Appendix B

Resolutions, Widths, Speeds, Emulations, & Custom Adjustments

Print Resolutions and Widths

Resolutions and Widths				
Model	Printhead Resolution	Maximum Print Width		Default Setting
		Inches	Millimeters	
H-4212 & H-4212X	203 dots/inch (8 dots/mm)	4.10	104.1	4.10
H-4310 & H-4310X	300 dots/inch (12 dots/mm)	4.16	105.7	4.16
H-4408	406 dots/inch (16 dots/mm)	4.10	104.1	4.10
H-4606 & H-4606X	600 dots/inch (23.6 dots/mm)	4.16	105.7	4.16
H-6210 & H-6212X	203 dots/inch (8 dots/mm)	6.61	167.90	6.62
H-6308 & H-6310X	300 dots/inch (12 dots/mm)	6.40	162.60	6.64
H-8308X	300 dots/inch (12 dots/mm)	8.52	216.40	8.52

Speed Ranges

Speed Ranges and Defaults					
Model	Function	Speed Range		Default Setting	
		IPS	MMPS	IPS	MMPS
H-4212 & H-4212X	Print	2 – 12	51 – 305	8	203
	Feed	2 – 12	51 – 305	8	203
	Reverse	2 – 4	51 – 102	4	102
	Slew	2 – 16	51 – 406	8	203
H-4310 & H-4310X	Print	2 – 10	51 – 254	8	203
	Feed	2 – 12	51 – 305	8	203
	Reverse	2 – 4	51 – 102	4	102
	Slew	2 – 16	51 – 406	8	203
H-4408	Print	2 – 8	51 – 203	6	152
	Feed	2 – 10	51 – 254	6	152
	Reverse	2 – 4	51 – 102	4	102
	Slew	2 – 16	51 – 406	6	152
H-4606 & H-4606X	Print	2 – 6	51 – 152	4	102
	Feed	2 – 8	51 – 203	4	102
	Reverse	2 – 4	51 – 102	4	102
	Slew	2 – 16	51 – 406	4	102
H-6210	Print	2 – 10	51 – 254	6	152
	Feed	2 – 12	51 – 305	6	152
	Reverse	2 – 4	51 – 102	4	102
	Slew	2 – 12	51 – 305	6	152
H-6212X	Print	2 – 12	51 – 305	8	203
	Feed	2 – 12	51 – 305	8	203
	Reverse	2 – 4	51 – 102	4	102
	Slew	2 – 14	51 – 356	8	203
H-6308	Print	2 – 8	51 – 203	6	152
	Feed	2 – 10	51 – 254	6	152
	Reverse	2 – 4	51 – 102	4	102
	Slew	2 – 10	51 – 254	6	152
H-6310X	Print	2 – 10	51 – 254	8	203
	Feed	2 – 12	51 – 305	8	203
	Reverse	2 – 4	51 – 102	4	102
	Slew	2 – 14	51 – 356	8	203
H-8308X	Print	2 – 8	51 – 203	6	152
	Feed	2 – 10	51 – 254	6	152
	Reverse	2 – 4	51 – 102	4	102
	Slew	2 – 12	51 – 305	6	152

Custom Adjustment Ranges

Row, Column, and Present Adjust Ranges (in dots)			
Model	Row Adjust and Present Adjust	Column Adjust	Default Setting
H-4212, H-4212X & H-6212X	-100 – 2030	-100 – 100	000
H-4310, H-4310X, H-6308, H-6310X, & H-8308X	-150 – 3000	-150 – 150	
H-4408	-200 – 4060	-200 – 200	
H-4606 & H-4606X	-300 – 6000	-300 – 300	

Column & Row Emulation Ranges

Emulation Ranges (in dots)			
Model	Column	Row	Default Setting
H-4212, H-4212X & H-6212X	153 – 203	103 – 303	203
H-4310, H-4310X, H-6308, H-6310X, & H-8308X	250 – 300	200 – 400	300
H-4408	356 – 406	306 – 506	406
H-4606 & H-4606X	550 – 600	500 – 700	600

Appendix C

RS-422/485 Port Configuration

The serial port can be configured for RS-422/485 communications, and / or a +5VDC (@ 0.5A maximum) source for powering external devices.



The Serial Port default configuration is "RS-232" and Pin 1 "Not Connected."

1. Turn OFF the printer and unplug the power cord.
2. Remove the communication cables from the Main Board.
3. Loosen and remove the two Screws securing the Main Board to the printer.



4. Slide the Main Board out of the printer then move the jumpers according the needs of the application:
 - For RS-422/485 operation, place the jumper across pins E4 and E5;
 - For +5VDC on Pin 1, place the jumper across pins E1 and E2; or,
 - For RS-232 operation (default), place the jumper across pins E5 and E6;
 - For no voltage on Pin 1 (default), place the jumper across pins E2 and E3.

Communication Jumper Locations

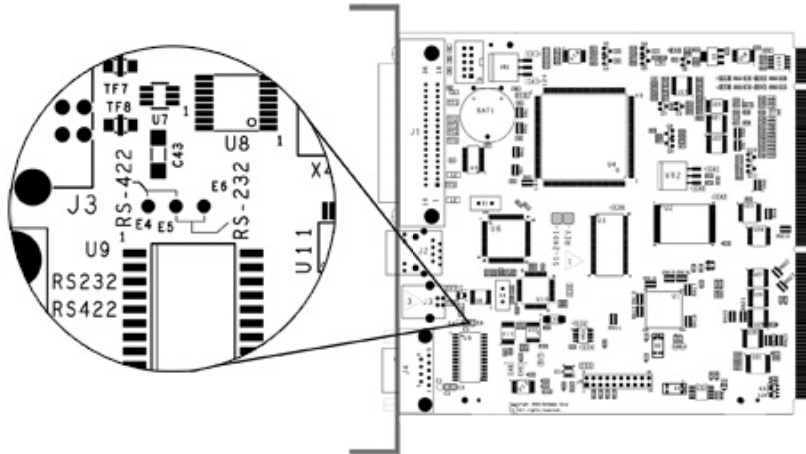

+5 Volts Jumper Location

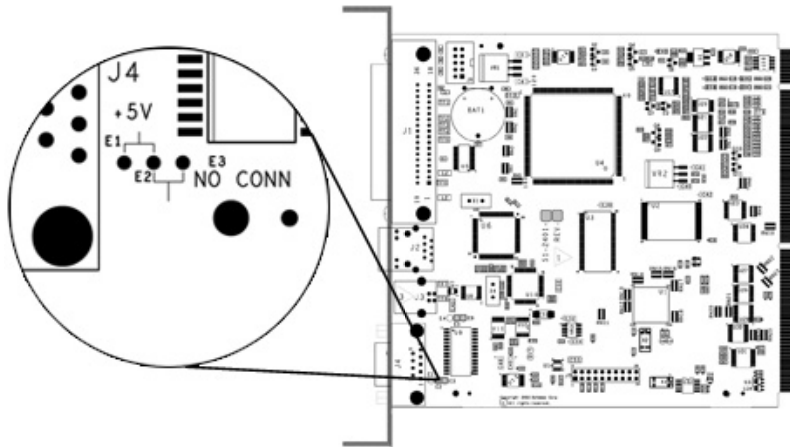

5. Slide the Main Board into the printer and secure it with the two previously removed Screws.
6. Connect communication cables to the Main Board and plug in the power cord.



For RS-422/485 communications, ensure that your cable meets the requirements (per the table, right) for proper data transfer.

Serial Port Pin Number	RS-422 & RS-485 Function
1	---
2	RX-
3	TX+
4	---
5	GND
6	---
7	TX-
8	RX+
9	---

Appendix D

Changing the Menu Language

Different languages and / or Datamax-O'Neil-provided translations can be downloaded to replace the standard (English) menu of the printer by changing the spreadsheet that defines the system dictionary. To change the language you will add a new language column (or modify the existing column) in the spreadsheet, click on the "Generate DPL file(s)" radio button, and then send that file(s) to the printer.

Software requirements for modifying the menu language are as follows:

- Microsoft® Excel must be purchased by user;
- Img2dl.exe (provided at <ftp://ftp.datamax-oneil.com/Anonymous/Firmware/EFIGS/>) is a program used during the process to create the DPL file; and,
- Common.xls (also provided at the web site above) is the Menu Dictionary.



Place *Img2dl.exe* and *Common.xls* in the same directory.

Create a Menu Language by following these steps:

- A. Invoke Excel and open the Common.xls file. *After the file opens, the following screen appears:*

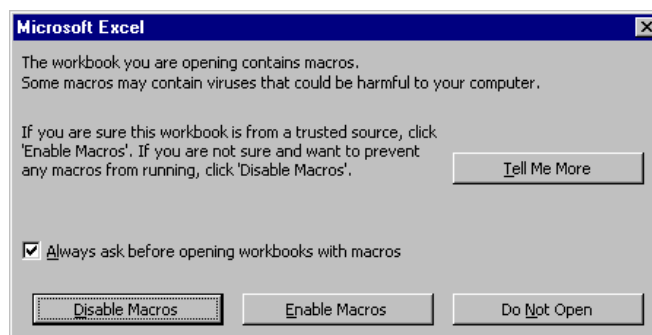

B. Click the "Enable Macro" box. *The following screen appears:*

	A	B	C	D	E	F	G
				Generate Source Files	Generate DPL File(s)		
2	NID	COMMENTS	MAX	MESSAGE ID	ENGLISH	FRANCAIS	ITALIANO
3	0000	System Messages		20 MID_READY	READY	PRÊT	PRONTO
4	0001			20 MID_PRINTING	PRINTING		
5	0002			20 MID_PAUSED	PAUSED	PAUSE	IN PAUSA
6	0003	1Aa		20 MID_CANCEL_PRINT_JOB	CANCEL PRINT JOB?		
7	0004			20 MID_CLEARING_FAULTS	CLEARING FAULTS		CANCELLA ERRORI
8	0005			10 MID_OF	OF	DE	DI
9	0006			20 MID_DOTCHECK_IN_PROGRESS	DOTCHECK IN PROGRESS		
10	0007	Faults		20 MID_SYSTEM_FAULT	SYSTEM FAULT	DEFAILLANCE SYSTEME	ANOMALIA SISTEMA
11	0008			20 MID_ADC_FAULT	ADC FAULT	DEFAILLANCE ADC	ANOMALIA ADC
12	0009			20 MID_HEAD_UP_FAULT	HEAD UP FAULT	TETE NON VEROUILLEE	ANOM. TESTINA ALTA
13	0010			20 MID_RIBBON_FAULT	RIBBON FAULT	DEFAILLANCE RUBAN	ANOMALIA NASTRO
14	0011			20 MID_TOP_OF_FORM_FAULT	TOP OF FORM FAULT	DEFAIL. DEBUT D'IMP.	ANOMALIA BORDO SUP
15	0012			20 MID_OUT_OF_STOCK	OUT OF STOCK	RUPTURE PAPIER	ESAURITO
16	0013			20 MID_CUTTER_FAULT	CUTTER FAULT	DEFAILLANCE COUTEAU	ANOMALIA TAGLIERIN
17	0014			20 MID_VERIFIER_FAULT	VERIFIER FAULT	DEFAILLANCE VERIFIC.	ANOMALIA VERIFICAT
18	0015			20 MID_RIBBONSAVER_FAULT	RIBBONSAVER FAULT	DEFAIL. ECONOM. RUBAN	ANOM. SALVA-NASTRO
19	0016			20 MID_POSITION_FAULT	POSITION FAULT	DEFAILLANCE POSITION	ANOM. POSIZIONAMEN
20	0017			20 MID_TEMPERATURE_FAULT	TEMPERATURE FAULT		
21	0018			20 MID_DMA_FAULT	DMA FAULT	DEFAILLANCE DMA	ANOMALIA DMS
22	0019			20 MID_PRINT_ENGINE_FAULT	PRINT ENGINE FAULT	DEFAILLANCE MOTEUR	
23	0020			20 MID_24V_OUT_OF_TOLERANCE	24V OUT OF TOLERANCE	DEPASS. TOLERANCE 24V	24V FUORI TOLLERAN
24	0021			20 MID_STROBE_TIMING_FAULT	STROBE TIMING FAULT	DEFAIL. DUREE D'IMPULSION	ANOM. FASAT STROB
25	0022	Warnings		20 MID_WARNING_RESOLVED	WARNING RESOLVED	AVERTISSEMENT RESOLU	AVVERTENZA RISOLTA
26	0023			20 MID_RIBBON_LOW	RIBBON LOW	RUBAN FAIBLE	NASTRO BASSO
27	0024			20 MID_GAP_MISSED	GAP MISSED	INTERVALLE MANQUANT	INTERVALLO SALTATO
28	0025			20 MID_DOT_FAILURE	DOT FAILURE	DEFAUT IMPRESSION	ANOMALIA PUNTO
29	0026			20 MID_BAD_SENSOR_DELTA	BAD SENSOR DELTA		
30	0027			20 MID_HOST_CHANGES_PENDING	HOST CHANGES PENDING		MOD. HOST IN ATTES
31	0028			20 MID_LOW_VOLTAGE	LOW VOLTAGE		
32	0029			20 MID_GOODBYE	GOODBYE		
33	0030	Conditions		20 MID_REMOVE_LABEL	REMOVE LABEL	ENLEVER ETIQUETTE	RIMUOVI ETICHETTA
34	0031			20 MID_TEMPERATURE_PAUSE	TEMPERATURE PAUSE		

C. Click On Column J and enter the new language, or modify an existing one. Some tips on this process:

- Message Size – When entering new messages, reference the "MAX" column: this is the maximum number of characters allowed for this field. (Warnings are displayed when the number of characters is exceeded, or when trying to modify the MAX value; however, if "cutting and pasting" fields, this warning system may be defeated.)
- Two Line Messages – Some of the message are displayed as two lines. These are indicated in the comment fields.
- Comments – This field can be modified with no effect.

D. After editing is complete, highlight all of the columns to be created by pressing the letter above the column (more than one column can be selected).

E. Press the Generate DPL File(s) radio button. *A file will be generated for each of the selected columns and Excel will provide confirmation (for example, as shown below, small.ls).*

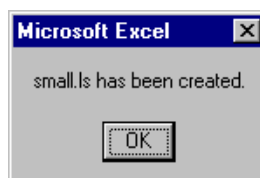

- F. Download the generated files to the printer – one method is the DOS copy command:

```
copy small.ls lpt1: /b
```

- G. Reset the printer by pressing and holding the CANCEL Key for approximately four seconds.
- H. After resetting, verify operation by printing a Configuration Label (see Section 4.3.5). *New language information will be printed under SYSTEM INFORMATION / OPTIONAL LANGUAGES. (Also, the new language will appear on the display as a menu item in SYSTEM SETTINGS / MENU LANGUAGE. These are the only methods to determine a successful download.)*

Enable the new language. Enter the menu system and go to SYSTEM SETTINGS / MENU LANGUAGE and select the new language (*A reset will occur as font validation is performed.*)

Afterward, reenter the menu system and go to SYSTEM SETTINGS / MENU LANGUAGE and select the desired font for the language. Save the changes when prompted.

An error has occurred if the printer displays the new language selection, but all messages remain in English. In this case, re-check your process or contact Datamax-O'Neil Technical Support (be ready to provide the Common.xls and DPL download files created). Other error messages are also possible:

Menu Language Error Message	Description
Please select the entire column(s) or the desired language(s), by clicking on the column letter(s)	After pressing the Generate DPL File(s) radio button, the languages to convert were not correctly selected.
Message text may not exceed MAX = xx designated characters for this MID	The entered message exceeds the number of characters specified in column C. You may not modify this number.

- I. Repeat Steps A – H using the filename misc.xls to translate printer option items. This will output small20.ls.

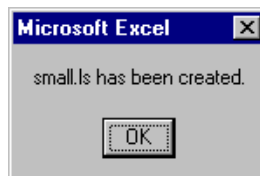

Advanced File Handling Information

- The standard printer leaves the factory with EFIGS loaded into Module Y. At this point, Module Y is LOCKED and will only accept additional language downloads.

- After downloading a language update, Module Y is left UNLOCKED until the printer is reset or power is cycled. In this state, Module Y will accept font, image and label format downloads. The module will also honor the Clear Module request. Therefore, following an update it is recommended that a reset be performed to lock the module; otherwise, a software package may “Clear All Modules” thus destroying the new menu language(s).
- Module Y can be UNLOCKED by sending this DPL string: <STX>KpY0
- To restore the factory generated EFIGS image, download the file *832296.01A to the printer. This file is located on the Datamax-O’Neil FTP site. The letter at the end of the file name (e.g., A) specifies the revision. The latest revision will be available on the FTP site.
- Downloading the same language twice will automatically delete the first occurrence, but will not free the memory space.
- Deletion of the selected language will reset the printer to English. The total number of languages that the printer can now accept is limited to 10, but this number is dependent upon the size of each language translation. The translation size will vary with the number of messages that are translated for that particular language. Current complete language files are about 7,000 bytes each; but with product growth, the total number of languages is expected to drop to five.
- The screen shot below is an example of Unicode defined Languages, Chinese & Russian. Note the only additional information required is the “double” in row 1.

	I	J	K	L	M
1				Double	Double
2	ESPAÑOL	small	TREK	Chinese	RUSSIAN
3	LISTO	ready	AWAITING ORDERS	准备	ГОТОВ
4	IMPRIMIENDO	printing	WARP DRIVE ENGAGED	打印中	ПЕЧАТЬ
5	EN PAUSA	paused	ALL STOP	暂停	ПАУЗА
6	CANCELAR IMPRESIÓN	cancel batch?	ABORT MISSION?	取消	ОТМЕНИТЬ ЗАДАНИЕ?
7	BORRAR ERRORES	clearing faults	RE-INITIALIZING	清除错误	СБРОС ОШИБОК
8	DE	of	FACTOR	OF	ОФ
9		advanced menu	KNOWLEDGE BASE	高级菜单	МЕНЮ
10	ERROR DE SISTEMA	system fault	DIRECT HIT SUSTAINED	系统错误	СИСТЕМНАЯ ОШИБКА
11	ERROR DE ADC	adc fault	HULL BREACH DECK TEN	ADC错误	ОШИБКА ADC
12	CABEZAL LEVANTADO	head up fault	ENGINES OFFLINE	打印头抬起错误	ТЕРМОГОЛОВКА ПОДНЯТА
13	ERROR DE CINTA	ribbon fault	PHASORS OFFLINE	破带错误	ОШИБКА РИВОНА
14	ERROR INICIO ETIQ.	top of form fault	UNABLE TO GO TO WARP	TOF错误	ОШИБКА ГРАНИЦ ЭТИКЕТКИ
15	SIN PAPEL	out of stock	TORPEDO TUBES EMPTY	标签用完	ОТСУТСТВУЕТ ЭТИКЕТКА
16	ERROR DE CORTADOR	cutter fault	CASCADE FAILURE	切刀错误	ОШИБКА РЕЗАКА
17	ERROR DE VERIFICADOR	verifier fault	TRACTOR BEAM FAILURE	检测器出错	ОШИБКА ВЕРИФИКАТОРА
18	ERROR ECONOM. CINTA	ribbonsaver fault	METAPHASIC FAILURE	破带节约装置错误	ОШИБКА РИВОНСЕЙВЕР
19	ERROR DE POSICION	position fault	UNKNOWN COORDINATES	位置错误	ОШИБКА ПОЛОЖЕНИЯ
20	FALLO DE TEMPERATURA	temperature fault	CORE TEMP. CRITICAL	温度错误	ОШИБКА ТЕМПЕРАТУРЫ
21	ERROR DMA	dma fault	COMPUTER MALFUNCTION	DMA错误	ОШИБКА DMA
22	ERROR MOTOR IMPRES.	print engine fault	PORT NACELL OFFLINE	打印引擎错误	ОШИБКА ДВИГАТЕЛЯ
23	24V FUERA TOLERANCIA	24v out of tolerance	SAFETY LIMIT EXCEEDED	电压越界	ОШИБКА ВОЛЬТАЖА
24		present sensor fault	INERT. DAMP. OFFLINE	出纸检测器错误	ОШИБКА ДАТЧИКА НАЛИЧИЯ
25	ADVERTEN. CORREGIDA	warning resolved	ALL CLEAR	警告	ПРОБЛЕМА УСТРАНЕНА
26	CINTA BAJA	ribbon low	TORPEDO TUBES LOW	破带不多	КОНЧАЕТСЯ РИВОН
27		head/cover up fault	LANDING FAULT	打印头抬起错误	ПОДНЯТА КРЫШКА
28	FALLO PUNTO CABEZAL	dot failure	SHIELDS COMPROMISED		ОШИБКА ТЕРМОГОЛОВКИ
29		label rotation	SYMMETRY INVERSION	标签旋转	ЭТИКЕТКА ПОВЕРНУТА
30	CAMBIOS PENDIENTES	host changes pending	HOSTILE APPROACHING	主机更改评估中	ОБНОВЛЕНИЕ ХОСТА

Appendix E

Saving a Configuration File

Configuration files save and restore printer settings, eliminating the need for special repeated printer setups. Unique filenames can be assigned and settings restored via the host or printer menu. The following example saves a media calibration as a configuration file:



If file sharing among multiple printers, DO NOT include unique parameters (such as calibrations and adjustments).

Step	Action	Displayed Message
A	With the printer set for the configuration to be saved, press the any Navigation Button.	SELECT FUNCTION
B	Scroll to ADVANCED MENU and then press the RIGHT Button. (Or, to quit this procedure press the EXIT Key.)	ADVANCED MENU
C	Scroll to SYSTEM SETTINGS and then press the RIGHT Button.	SYSTEM SETTINGS
D	Press the RIGHT Button.	CONFIGURATION FILE
E	Scroll to SAVE SETTING AS then press the RIGHT Button.	SAVE SETTING AS
F	Use the buttons to assign a name to the Configuration File; up to eight characters can be used.	SAVE SETTING AS
G	Press the ENTER Key to save.	SUCCESSFUL



To restore a configuration file via the menu, see Section 4.2.4.

Appendix F

Ethernet Setup

Because the Print Server makes IP requests at power-up, before making a network connection to the printer consider how your IP Addressing needs to be assigned.

IP Addressing of the Internal Ethernet Print Server can be configured two ways:

- Using a static IP Address; or,
- Using IP Discovery (DHCP, BootP, or RARP).

Proceed according to the desired addressing method:



At factory default settings, IP DISCOVERY is DISABLED.

Configuration Using a Static IP Address

Assign a static IP Address by following the steps below:

- A. Without connecting the Ethernet cable, turn ON the printer.
- B. Press the MENU Button then scroll to COMMUNICATIONS / NIC ADAPTER / IP ADDRESS.



- *For access to all functions, ensure that the Advanced Menu is selected: Press **System Settings** select **Menu Mode** and then **Advanced Menu**.*
-

- C. Use the UP and DOWN Buttons to increment or decrement each numeric value, and use the RIGHT button to move to the cursor to the next digit. After all fields have been input, press ENTER.
- D. Scroll to SUBNET MASK and set that address (see Step C, above).
- E. Scroll to GATEWAY and set that address (see Step C, above).
- F. If needed, set your SNMPTRAP DESTINATION address (see Step C, above, or use the HTML pages, see Appendix G).
- G. After entering the addresses, press EXIT and save your changes when prompted.
- H. Turn OFF the printer and connect the Ethernet cable. Turn ON the printer and then install the port and printer driver using the Windows "Add a Printer Wizard" and Driver and Port Setup (see Appendix H).

Configuration Using IP Discovery

DHCP, BootP, and RARP are services that provide a method for assigning and maintaining IP Addresses. With IP Discovery enabled, the Print Server obtains IP information from this service. IP Discovery must first be enabled for use. Assign IP Discovery by following the steps below:



When IP DISCOVERY is ENABLED you will not be able to change the IP ADDRESS, SUBNET MASK, or GATEWAY.

- A. Without connecting the Ethernet cable, turn ON the printer. Press the MENU Button.
- B. Scroll to COMMUNICATIONS > NIC ADAPTER > IP DISCOVERY. Select ENABLED and press ENTER.
- C. Press EXIT and save your changes when prompted.
- D. Turn OFF the printer. Connect the Ethernet cable and turn ON the printer.
- E. After the connection is established, obtain the Assigned IP Address (see below) by printing a Configuration Label; see Section 4.3.5.

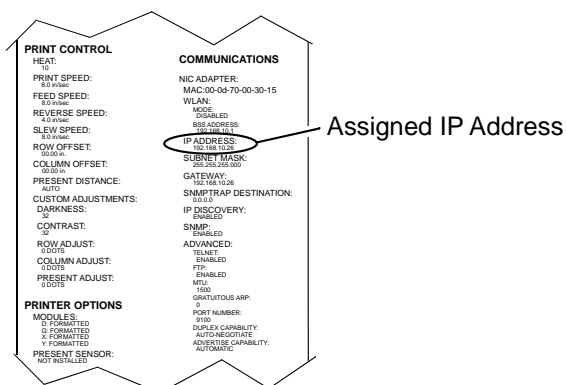

Depending upon your server, it may take a minute or two for the Assigned IP Address to appear on the label.

- F. After the Assigned IP Address has been obtained, install the port and printer driver using the Windows "Add a Printer Wizard" and Driver and Port Setup (see Appendix H).

Using the HTML Pages

The resident HTML (Web) pages allow configuration of network and printer settings, status queries, and diagnostic tests. To configure the Print Server and other internal printer settings, you can access the printer via HTML pages using any Web browser. Samples and comment text is given in the screenshots that follow.

Access the HTML Pages as follows:

- A. In your Web browser, choose File > Open.
- B. Enter the IP address of the Print Server and press Enter. (The default IP Address is 192.168.10.2)



Consult with your system administrator for address, printer, and protocol information. The authentication password for setting changes is sysadm

Appendix G

Printer Driver and Port Setup





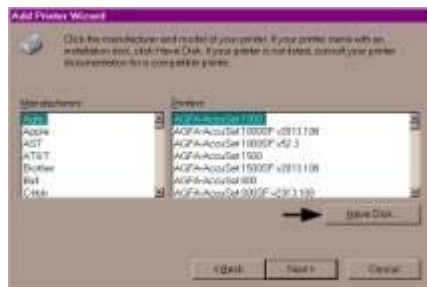

Install the Printer Driver and Port software according to the host's operating system.

Windows 95/98 Driver and Port Installation

<p>1 Start the Windows "Add Printer Wizard" and this screen should appear. Click Next>.</p>	<p>2 Ensure that Local Printer is selected and then click Next.</p>
<p>3 Click on Have Disk.</p>	<p>4 Insert the Accessories CD-ROM and click Browse.</p>

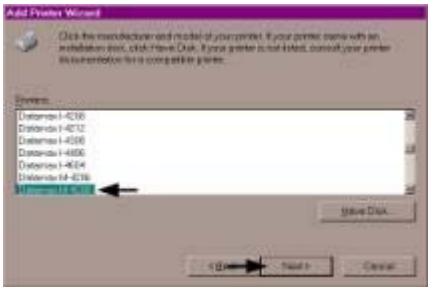

Windows 95/98 Driver and Port Installation (continued)

<p>5 Browse to the “\DRIVERS\Seagull” folder on the CD-ROM, ensure the file “xp.inf” is selected and click OK.</p>		<p>6 Click OK.</p>	
<p>7 Select your printer from the list and then click Next.</p>		<p>8 Your computer will now copy the necessary files from the CD-ROM.</p>	
<p>9 When prompted to choose a port, select FILE and click Next. (Later, you will setup the network port from the printer properties.)</p>		<p>10 Name your printer in the Printer Name: field. Next select whether or not to set this printer as your default printer. Then Click Finish.</p>	

Windows 95/98 Driver and Port Installation (continued)

11 From the Windows desktop click Start / Settings / Printers.

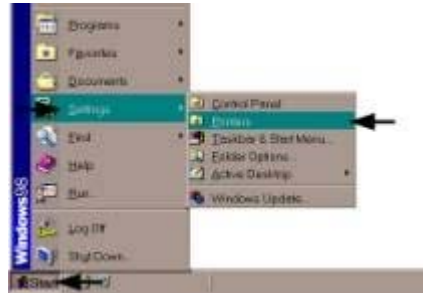

12 After the Printers window opens, right-click on the printer icon and select Properties from the drop down menu.



13 Click on the Details tab and then click Add Port.

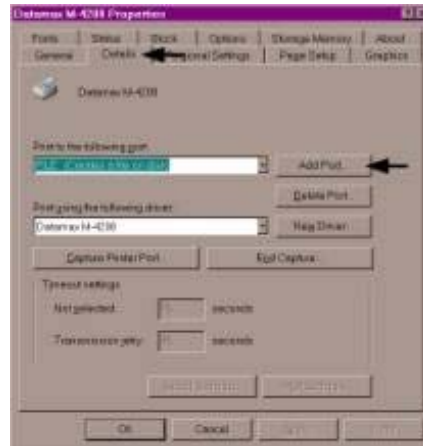

14 In the Add Port window, Select Other and "Seagull Scientific Port" and then click OK.

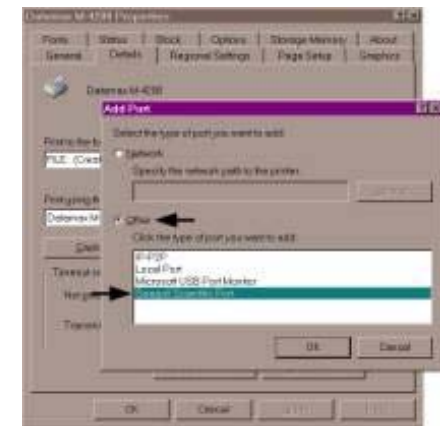

Windows 95/98 Driver and Port Installation (continued)

- 15** In the Name or IP Address: field, enter the IP address of your printer. The Port Number and Port Name fields do not need to be changed. When finished click OK.



- 16** Click Apply and then click OK.

The driver and port installation is now complete. The printer can be selected through any Window's application.

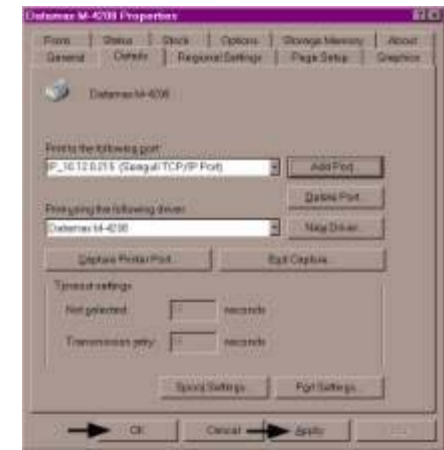

Windows NT 4.0 Driver and Port Installation

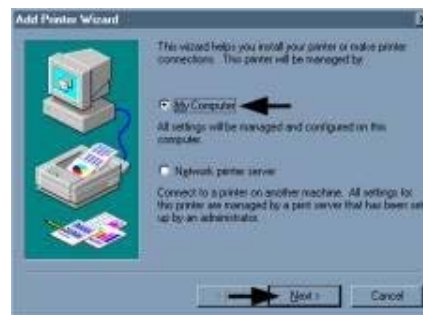

- 1** Start the Windows "Add Printer Wizard". Ensure that My Computer is selected and then click Next.



- 2** Click Add Port.

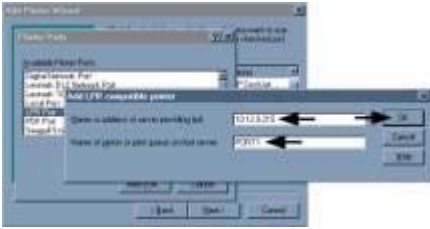

Windows NT 4.0 Driver and Port Installation (continued)

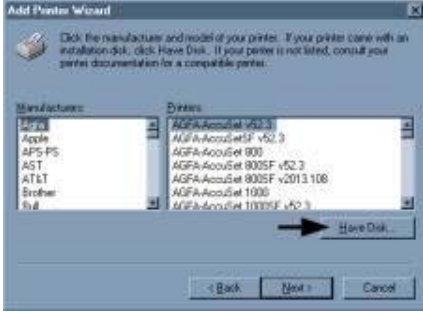
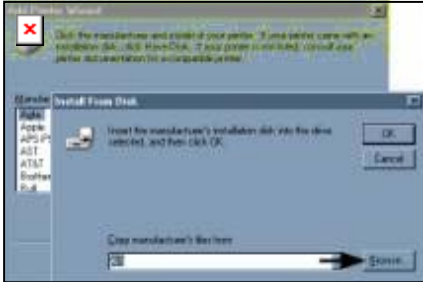
<p>3 Double-click LPR Port.</p> 	<p>4 In the top field enter the IP address of your printer. In the bottom field enter PORT1. When finished click OK.</p> 																		
<p>5 Click Close.</p> 	<p>6 Click Next.</p>  <table border="1" data-bbox="1619 760 1885 873"> <thead> <tr> <th>Port</th> <th>Description</th> <th>Printer</th> </tr> </thead> <tbody> <tr> <td><input type="checkbox"/> C:\winnt\system32\pdf</td> <td>PDF Port</td> <td>Acrobat Distiller</td> </tr> <tr> <td><input checked="" type="checkbox"/> LPT1</td> <td>Local Port</td> <td>HP DeskJet...</td> </tr> <tr> <td><input type="checkbox"/> LPT2</td> <td>Local Port</td> <td></td> </tr> <tr> <td><input type="checkbox"/> LPT3</td> <td>Local Port</td> <td></td> </tr> <tr> <td><input type="checkbox"/> COM1</td> <td>Local Port</td> <td></td> </tr> </tbody> </table>	Port	Description	Printer	<input type="checkbox"/> C:\winnt\system32\pdf	PDF Port	Acrobat Distiller	<input checked="" type="checkbox"/> LPT1	Local Port	HP DeskJet...	<input type="checkbox"/> LPT2	Local Port		<input type="checkbox"/> LPT3	Local Port		<input type="checkbox"/> COM1	Local Port	
Port	Description	Printer																	
<input type="checkbox"/> C:\winnt\system32\pdf	PDF Port	Acrobat Distiller																	
<input checked="" type="checkbox"/> LPT1	Local Port	HP DeskJet...																	
<input type="checkbox"/> LPT2	Local Port																		
<input type="checkbox"/> LPT3	Local Port																		
<input type="checkbox"/> COM1	Local Port																		
<p>7 Click on Have Disk.</p> 	<p>8 Insert the Accessories CD-ROM and click Browse.</p> 																		

Windows NT 4.0 Driver and Port Installation (continued)

<p>9 Browse to the “\DRIVERS\Seagull\Nt4\” folder on the CD-ROM, ensure the file “for nt 4.0 only...” is selected and click Open.</p>	<p>10 Click OK.</p>
<p>11 Select your printer from the list and then click Next.</p>	<p>12 Name your printer in the Printer name: field. Next select whether or not to set this printer as your default printer. Then Click Next.</p>
<p>13 Select whether or not to share this printer on your network. Then Click Next.</p>	<p>14 Select No then Click Finish.</p>

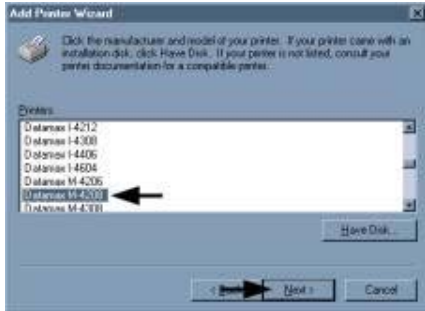

Windows NT 4.0 Driver and Port Installation *(continued)*

15 Your computer will now copy the necessary files from the CD-ROM.

The driver and port installation is now complete. The printer can be selected through any Window's application.



Windows 2000 Driver and Port Installation





1 Start the Windows "Add Printer Wizard". The following screen should appear, click Next>.



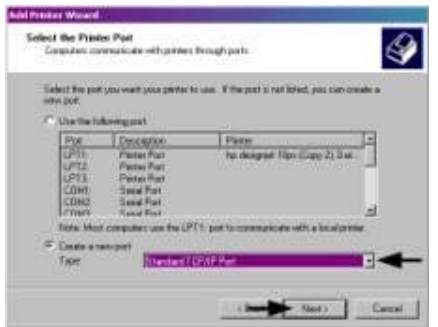

2 Ensure that Local Printer is selected and then click Next.

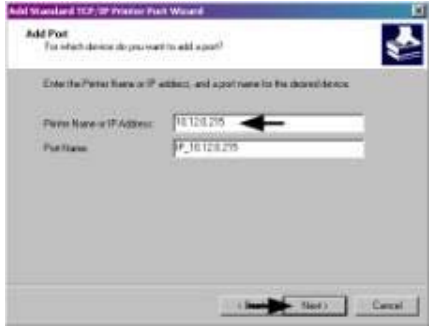
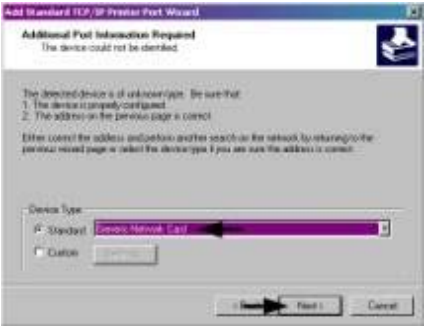

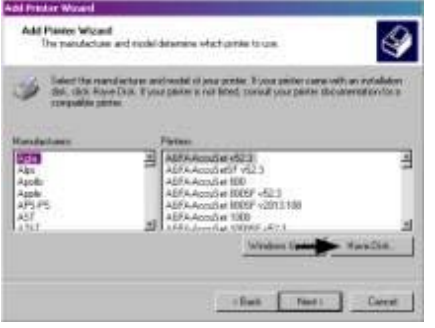
Windows 2000 Driver and Port Installation (continued)

<p>3 Select on Create a new port: and then select Standard TCP/IP Port from the drop down menu. Click Next.</p>		<p>4 Click Next.</p>	
<p>5 In the Printer Name or IP Address: field enter the IP address of your printer. The Port Name field does not need to be changed. When finished click Next.</p>		<p>6 Ensure Standard is selected and then click Next.</p>	
<p>7 Confirm your settings and then click Finish.</p>		<p>8 Click on Have Disk.</p>	

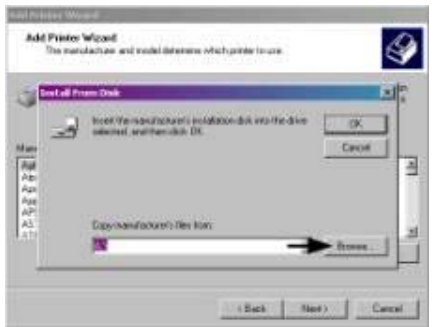
Windows 2000 Driver and Port Installation (continued)

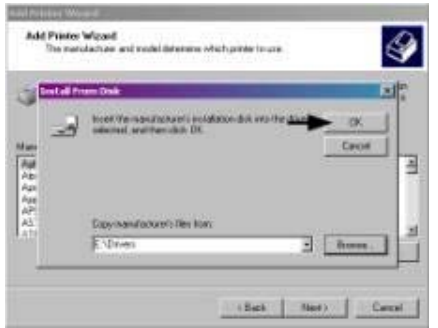
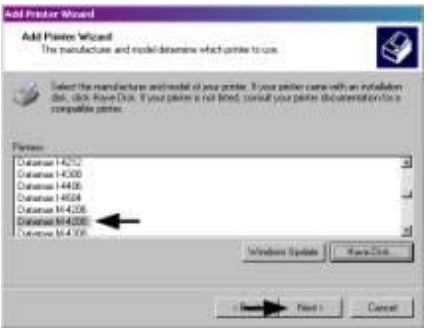
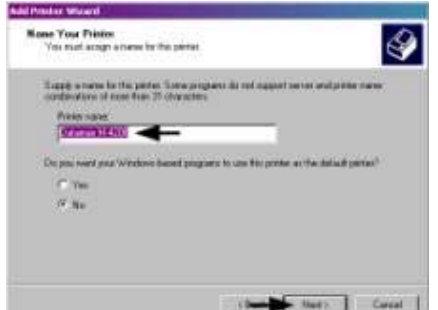
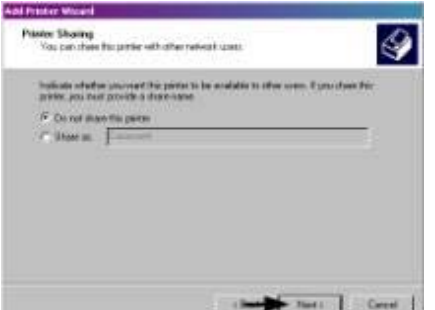
<p>9 Insert the Accessories CD-ROM and click Browse.</p>		<p>10 Browse to the "\\DRIVERS\Seagull" folder on the CD-ROM, ensure the file "xp.inf" is selected and click OK.</p>	
<p>11 Click OK.</p>		<p>12 Select your printer from the list and then click Next.</p>	
<p>13 Name your printer in the Printer name: field. Next select whether or not to set this printer as your default printer. Then Click Next.</p>		<p>14 Select whether or not to share this printer on your network. Then Click Next.</p>	

Windows 2000 Driver and Port Installation (continued)

15 Select No then Click Next.



16 Confirm your settings and then click Finish.



17 If prompted with the "Digital Signature Not Found" window, click Yes to continue installation.









18 Your computer will now copy the necessary files from the CD-ROM.





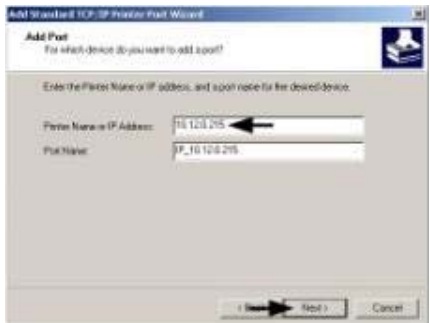

The driver and port installation is now complete. The printer can be selected through any Window's application.



Windows XP Driver and Port Installation

<p>1 Start the Windows "Add Printer Wizard." The following screen should appear. Click Next>.</p>		<p>2 Ensure that Local Printer is selected and then click Next.</p>	
<p>3 Select on Create a new port: and then select Standard TCP/IP Port from the drop down menu. Click Next.</p>		<p>4 Click Next.</p>	
<p>5 In the Printer Name or IP Address field enter the IP address of your printer. The Port Name field does not need to be changed. When finished click Next.</p>		<p>6 Ensure Standard is selected and then click Next.</p>	

Windows XP Driver and Port Installation (*continued*)

<p>7 Confirm your settings and then click Finish.</p>		<p>8 Click on Have Disk.</p>	
<p>9 Insert the Accessories CD-ROM and click Browse.</p>		<p>10 Browse to the "\\DRIVERS\Seagull" folder on the CD-ROM, ensure the file "xp.inf" is selected and click OK.</p>	
<p>11 Click OK.</p>		<p>12 Select your printer from the list and then click Next.</p>	

Windows XP Driver and Port Installation (continued)

<p>13 Name your printer in the Printer name: field. Next select whether or not to set this printer as your default printer. Then Click Next.</p>		<p>14 Select whether or not to share this printer on your network. Then Click Next.</p>	
<p>15 Select No then Click Next.</p>		<p>16 Confirm your settings and then click Finish.</p>	
<p>17 If prompted with the "Digital Signature Not Found" window, click Continue Anyway to continue installation.</p>		<p>18 Your computer will now copy the necessary files from the CD-ROM. The driver and port installation is now complete. The printer can be selected through any Window's application.</p>	

Glossary

alphanumeric Consisting of alphabetic, numeric, and other symbols.

backing material The silicon-coated paper carrier material to which labels with adhesive backing are affixed. Also referred to as “liner”.

bar code A representation of alphanumeric information in a pattern of machine-readable marks. The basic categories are divided into one-dimensional (UPC, Code 39, Postnet, etc.) and two-dimensional bar codes (Data Matrix, MaxiCode, PDF417, etc.).

boot loader The resident program that loads the application from Flash memory, decompresses it into the SRAM, and starts operations.

burn line The row of thermal elements in the printhead that create the images on the media.

calibration The process through which sample values are entered into the printer for correct sensor function (for example, detection of a given media type) and TOF positioning.

character set The entire complement of alphanumeric symbols contained in a given font.

checksum An alphanumeric error detection method used in many bar code symbologies for informational security.

continuous media An uninterrupted roll or box of label or tag stock media that contains no gap, notch, or mark to separate individual labels or tags.

core diameter The inside diameter measurement of the cardboard core at the center of a ribbon or media roll.

cutter A mechanical device with a rotary or guillotine type blade used to cut labels or tags following printing.

defaults The functional setting values returned following a factory reset of the printer.

diagnostics Programs used to locate and diagnose hardware problems.

die-cut media Media that has been cut into a pattern using a press, where the excess paper is removed leaving individual labels, with gaps between them, attached to a backing material.

direct thermal The printing method that uses a heat sensitive media and only the heat of the thermal printhead to create an image on the label.

direct thermal media Media coated with special chemicals that react and darken with the application of heat.

DPI (dots per inch) A measurement of print resolution, rated in the number of thermal elements contained in one inch of the printhead. Also referred to as "resolution".

DPL (Datamax-O'Neil Programming Language) programming commands used specifically for control of and label production in Datamax-O'Neil printers. A complete listing of commands can be found in the *Class Series 2 Programmer's Manual*.

EFIGS English, French, Italian, German, Spanish, and other multi-language support as programmed for the menu and configuration label.

fanfold Media that is folded and stacked.

feed speed The speed at which the media moves under the printhead in non-printed areas and between labels.

Flash memory Non-volatile memory (does not require printer power to maintain data) that can be erased and reprogrammed, used to hold the operating program.

font A set of alphanumeric characters that share a particular typeface.

gap A space between die-cut or notched labels used to sense the top-of-form.

IPS (inches per second) Imperial measurement of printer speeds.

label A paper or synthetic printing material, typically with adhesive backing.

label length The distance from the top of the label to the bottom of the label as it exits the printer.

label repeat The distance from the top of one label to the top of the next label.

label tracking Excessive lateral (side to side) movement of the media as it travels under the printhead.

label width The left to right measurement of the label as it exits the printer.

mark Generalized term for the carbon-based black line on the underside of reflective media used to indicate the top-of-form.

media Generalized term for all types of printing stocks, including: roll fed, continuous, die-cut, reflective, and fanfold.

media hub Device in the printer used to support roll media.

media sensor An electronic device equipped with photosensors to detect media and the top-of-form on die-cut, notched or reflective media.

MMPS (millimeters per second) Metric measurement of printer speeds.

notched stock Media, typically tag stock, with holes or notches in the material that is used to signal the top-of-form. The printer must be set to "gap" to use this media type.

notched stock Media, typically tag stock, with holes or notches in the material that is used to signal the top-of-form. The printer must be set to "gap" to use this media type.

on demand An output regulator (i.e., the Present Sensor) that inhibits printing when a label is already present.

preprinted media Label stock that contains borders, text, or graphics, floodcoating, etc.

perforation Small cuts extending through the backing and/or label material to facilitate their separation. Also referred to as "perf".

print speed The speed at which the media moves under the printhead during the printing process.

reflective media Media imprinted with carbon-based black marks on the underside of the material, which is used to signal the top-of-form when the "reflective" sensor is enabled.

registration Repeatable top to bottom alignment of printed labels.

reverse speed The backward rate of media motion into the printer during tear-off, peel and present and cutting operations for positioning the label at the start of print position.

ribbon An extruded polyester tape with several layers of material, one of which is ink-like, used to produce an image on the label. Also referred to as "foil".

ribbon wrinkle An undesirable overlapping of the ribbon during the printing process that leads to voids on the printed label, typically caused by an improper printhead leveling cam adjustment.

roll media A form of media that is wound upon a core.

start of print (SOP) The position on the label where printing begins; also, the signal that initiates GPIO-controlled printing.

tag stock A heavy paper or synthetic printing material, typically featuring a notch or black mark for TOF and no adhesive backing.

thermal transfer The printing method that creates an image by transferring ink from a ribbon onto the media using the heat from the thermal printhead.

TOF (top-of-form) The start of a new label as indicated by a label gap, notch, mark or programming.

void An undesirable blank space in a printed image.

